

TMOV® and iTMOV® Varistor Series



Agency Approvals

Agency	Agency Approval	Agency File Number
	UL 1449	E320116
	QC 42201-C001, QC42201-A001, IEC 60950-1 (Annex Q)	E1274/F
	IEC 61051-1, IEC 61051-2, IEC 60950-1 (Annex Q)	40021525

Additional Information



**Datasheet
iTMOV**



**Datasheet
TMOV**



**Resources
iTMOV**



**Resources
TMOV**



**Samples
iTMOV**



**Samples
TMOV**

Description

The Littelfuse TMOV® and iTMOV® thermally protected varistors represent a new development in integrated circuit protection. Both versions are comprised of radial leaded MOVs (Metal Oxide Varistors) with an integrated thermally activated element designed to open in the event of overheating due to the abnormal overvoltage, limited current, conditions outlined in UL1449. The TMOV® and iTMOV® varistor's integrated thermal element, in conjunction with appropriate enclosure design, helps facilitate SPD module compliance to UL1449 for both cord connected and permanently connected applications.

The TMOV® and iTMOV® varistors offer quick thermal response due to the close proximity of the integrated thermal element to the MOV body. The integrated configuration also offers lower inductance than most discrete solutions resulting in improved clamping performance to fast overvoltage transients.

The iTMOV® varistor differs from the TMOV® varistor by the inclusion of a third lead for the purpose of indicating that the MOV has been disconnected from the circuit. This lead facilitates connection to monitoring circuitry.

Additionally TMOV® and iTMOV® varistors are wave solderable, thus simplifying end product assembly by reducing the the expense and rework associated with hand soldering operations.

Features

- RoHS compliant and Lead-free available
- -55°C to +85°C operating temp range
- Designed to facilitate compliance to UL1449 for SPD products
- Three-lead version available for indication purposes
- High peak surge current rating up to 10kA
- Wave solderable
- Standard lead form and spacing option

Applications

- SPD Products
- AC Panel Protection Modules
- AC Line Power Supplies
- Surge Protected Strip Connectors
- AC Power Meters
- Relocatable AC Power Taps
- GFCI (Ground Fault Current Interrupter)
- UPS (Uninterruptable Power Supply)
- White Goods
- Plug-in SPD
- Inverters
- AC/DC Power Supplies

Absolute Maximum Ratings

• For ratings of individual members of a series, see Device Ratings and Specifications chart

Continuous	TMOV® and iTMOV® Varistor Series	Units
Steady State Applied Voltage:		
AC Voltage Range ($V_{M(A)C(R)M(S)}$)	115 to 750	V
Transient:		
Peak Pulse Current (I_{TM}) - For 8x20µs Current Wave, single pulse	6,000 to 10,000	A
Single-Pulse Energy Capability - For 2ms Current Wave	35 to 480	J
Operating Ambient Temperature Range (T_A)	-55 to +85	°C
Storage Temperature Range (T_{STG})	-55 to +125	°C
Temperature Coefficient (α_V) of Clamping Voltage (V_C) at Specified Test Current	<0.01	%/°C
Hi-Pot Encapsulation (COATING Isolation Voltage Capability)	2,500	V
Thermal Protection Isolation Voltage Capability (when operated)	600	V
COATING Insulation Resistance	1,000	MΩ
Indicator Lead Rating (Lead-3 - iTMOV® varistor only):		
Continuous RMS current	100	mA
Surge Current, 8/20µs	10,000	A

CAUTION: Stresses above those listed in "Absolute Maximum Ratings" may cause permanent damage to the device. This is a stress only rating and operation of the device at these or any other conditions above those indicated in the operational sections of this specification is not implied.

Ratings & Specifications

TMOV® Varistor Lead-free And RoHS Compliant Models		iTMOV® Varistor Lead-free and RoHS Compliant Models		Disc Diameter	Maximum Rating (85°C)					Specifications (25°C)				
Part Number	Branding	Part Number	Branding		Continuous		Transient			Varistor Voltage at 1mA Test Current		Maximum Clamping Voltage 8/20µs		Typical Capacitance f = 1MHz
					$V_{M(A)C(R)M(S)}$	$V_{M(D)C}$	W_{TM}	$I_{TM} 1 \times$ Pulse	$I_{TM} 2 \times$ Pulse	$V_{N(D)C}$ Min	$V_{N(D)C}$ Max	V_C	I_{PK}	C
(mm)	(V)	(V)	(J)	(A)	(A)	(V)	(V)	(A)	(pF)					
TMOV14RP115E	P4T115E	TMOV14RP115M	P4T115M	14	115	150	35	6000	4500	162	198	300	50	1100
TMOV20RP115E	P2T115E	TMOV20RP115M	P2T115M	20	115	150	52	10000	6500	162	198	300	100	2400
TMOV14RP130E	P4T130E	TMOV14RP130M	P4T130M	14	130	170	50	6000	4500	184.5	225.5	340	50	1000
TMOV20RP130E	P2T130E	TMOV20RP130M	P2T130M	20	130	170	100	10000	6500	184.5	225.5	340	100	1900
TMOV14RP140E	P4T140E	TMOV14RP140M	P4T140M	14	140	180	55	6000	4500	198	242	360	50	900
TMOV20RP140E	P2T140E	TMOV20RP140M	P2T140M	20	140	180	110	10000	6500	198	242	360	100	1750
TMOV14RP150E	P4T150E	TMOV14RP150M	P4T150M	14	150	200	60	6000	4500	216	264	395	50	800
TMOV20RP150E	P2T150E	TMOV20RP150M	P2T150M	20	150	200	120	10000	6500	216	264	395	100	1600
TMOV14RP175E	P4T175E	TMOV14RP175M	P4T175M	14	175	225	70	6000	4500	243	297	455	50	700
TMOV20RP175E	P2T175E	TMOV20RP175M	P2T175M	20	175	225	135	10000	6500	243	297	455	100	1400
TMOV14RP200E	P4T200E	TMOV14RP200M	P4T200M	14	200	260	75	6000	4500	283	345	530	50	630
TMOV20RP200E	P2T200E	TMOV20RP200M	P2T200M	20	200	260	154	10000	6500	283	345	530	100	1250
TMOV14RP230E	P4T230E	TMOV14RP230M	P4T230M	14	230	300	80	6000	4500	324	396	595	50	550
TMOV20RP230E	P2T230E	TMOV20RP230M	P2T230M	20	230	300	160	10000	6500	324	396	595	100	1100
TMOV14RP250E	P4T250E	TMOV14RP250M	P4T250M	14	250	320	100	6000	4500	351	429	650	50	500
TMOV20RP250E	P2T250E	TMOV20RP250M	P2T250M	20	250	320	170	10000	6500	351	429	650	100	1000
TMOV14RP275E	P4T275E	TMOV14RP275M	P4T275M	14	275	350	110	6000	4500	387	473	710	50	450
TMOV20RP275E	P2T275E	TMOV20RP275M	P2T275M	20	275	350	190	10000	6500	387	473	710	100	900
TMOV14RP300E	P4T300E	TMOV14RP300M	P4T300M	14	300	385	125	6000	4500	423	517	775	50	400
TMOV20RP300E	P2T300E	TMOV20RP300M	P2T300M	20	300	385	250	10000	6500	423	517	775	100	800
TMOV14RP320E	P4T320E	TMOV14RP320M	P4T320M	14	320	420	136	6000	4500	459	561	840	50	380
TMOV20RP320E	P2T320E	TMOV20RP320M	P2T320M	20	320	420	270	10000	6500	459	561	840	100	750
TMOV14RP385E	P4T385E	TMOV14RP385M	P4T385M	14	385	505	150	6000	4500	558	682	1025	50	360
TMOV20RP385E	P2T385E	TMOV20RP385M	P2T385M	20	385	505	300	10000	6500	558	682	1025	100	700
TMOV14RP420E	P4T420E	TMOV14RP420M	P4T420M	14	420	560	160	6000	4500	612	748	1120	50	300
TMOV20RP420E	P2T420E	TMOV20RP420M	P2T420M	20	420	560	320	10000	6500	612	748	1120	100	600
TMOV14RP460E	P4T460E	TMOV14RP460M	P4T460M	14	460	610	180	6000	4500	675	825	1240	50	220
TMOV20RP460E	P2T460E	TMOV20RP460M	P2T460M	20	460	610	360	10000	6500	675	825	1240	100	200
TMOV14RP510E	P4T510E	TMOV14RP510M	P4T510M	14	510	670	185	6000	4500	738	902	1355	50	200
TMOV20RP510E	P2T510E	TMOV20RP510M	P2T510M	20	510	670	325	10000	6500	738	902	1355	100	350
TMOV14RP550E	P4T550E	TMOV14RP550M	P4T550M	14	550	715	190	6000	4500	819	1001	1500	50	180
TMOV20RP550E	P2T550E	TMOV20RP550M	P2T550M	20	550	715	360	10000	6500	819	1001	1500	100	300

Ratings & Specifications

TMOV [®] Varistor Lead-free And RoHS Compliant Models		iTMOV [®] Varistor Lead-free and RoHS Compliant Models		Disc Diameter	Maximum Rating (85°C)					Specifications (25°C)				
Part Number	Branding	Part Number	Branding		Continuous		Transient			Varistor Voltage at 1mA Test Current		Maximum Clamping Voltage 8/20 μ s		Typical Capaci- tance f = 1MHz
					AC Volts	DC Volts	Energy 2ms	Peak Surge Current 8/20 μ s		V _(NDCI) Min	V _(NDCI) Max	V _C	I _{PK}	C
				(mm)	V _{MACIRMS} (V)	V _{MDCI} (V)	W _{TM} (J)	I _{TM 1x} Pulse (A)	I _{TM 2x} Pulse (A)	V _(NDCI) (V)		V _C (V)	I _{PK} (A)	C (pF)
TMOV14RP575E	P4T575E	TMOV14RP575M	P4T575M	14	575	730	195	6000	4500	857	1047	1568	50	170
TMOV20RP575E	P2T575E	TMOV20RP575M	P2T575M	20	575	730	375	10000	6500	857	1047	1568	100	275
TMOV14RP625E	P4T625E	TMOV14RP625M	P4T625M	14	625	825	200	6000	4500	900	1100	1650	50	160
TMOV20RP625E	P2T625E	TMOV20RP625M	P2T625M	20	625	825	400	10000	6500	900	1100	1650	100	250
TMOV14RP750E	P4T750E	TMOV14RP750M	P4T750M	14	750	970	210	6000	4500	1080	1320	1980	50	140
TMOV20RP750E	P2T750E	TMOV20RP750M	P2T750M	20	750	970	480	10000	6500	1080	1320	1980	100	175

Thermal Characteristics



Note : The TMOV[®] and iTMOV[®] varistors are intended, in conjunction with appropriate enclosure design, to help facilitate SPD module compliance to UL 1449, 3rd Edition Section 39.4 (abnormal overvoltage limited current requirements). Under these extreme abnormal overvoltage conditions, some units will exhibit substantial heating, arcing and venting prior to opening. Modules should be designed to contain this possibility. Application testing is strongly recommended.

Maximum Clamping Voltage for 14mm Parts



Maximum Clamping Voltage for 20mm Parts

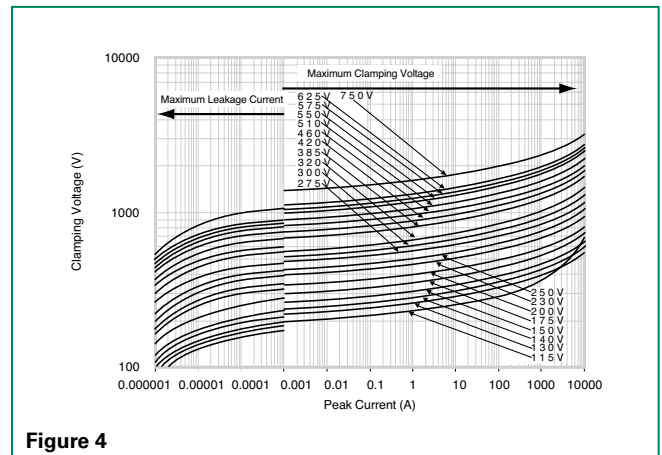

Repetitive Surge Capability for 14mm Parts



Figure 5

NOTE: Average power dissipation of transients should not exceed 0.6W

Repetitive Surge Capability for 20mm Parts

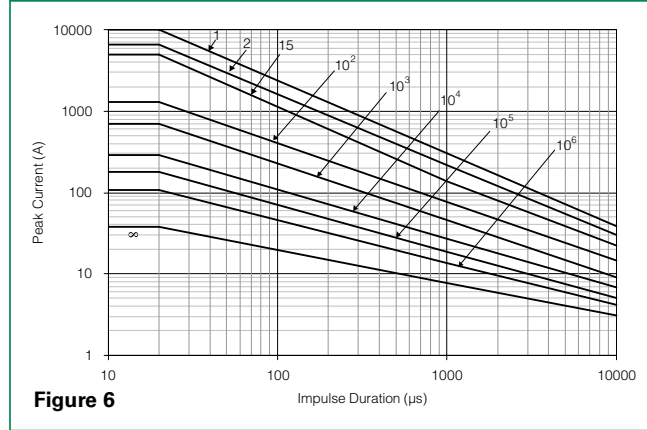

Figure 6

NOTE: Average power dissipation of transients should not exceed 1.0W

Wave Solder Profile

Because the TMOV® and iTMOV® varistors contain a thermal protection device, care must be taken when soldering the devices into place. Two soldering methods are possible. Firstly, hand soldering: It is recommended to heat-sink the leads of the device. Secondly, wave soldering: It is critically important that all preheat stage and the solder bath temperatures are rigidly controlled.

Non Lead-free Profile

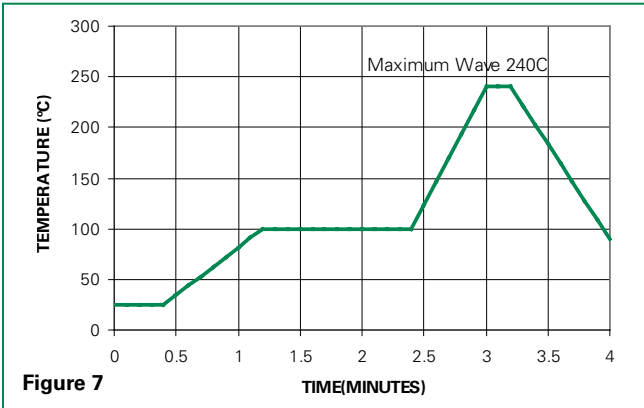

Figure 7

Lead-free Profile

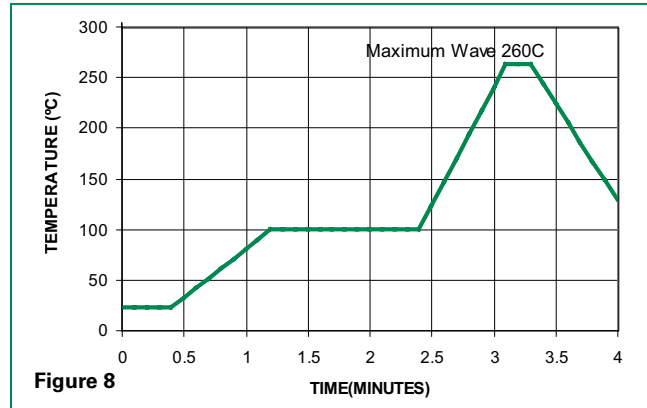

Figure 8

Physical Specifications

Lead Material	Copper clad steel wire
Soldering Characteristics	Solderability per MIL-STD-202, Method 208
Insulating Material	Cured, flame retardant epoxy polymer meets UL94V-0 requirements
Device Labeling	Marked with LF, voltage, UL/CSA logos, and date code

Environmental Specifications

Operating/Storage Temperature	-55°C to +85°C
Humidity Aging	+85°C, 85% RH , 1000 hours +/-10% typical voltage change
Thermal Shock	+85°C to -55°C 5 times +/-10% typical voltage change
Solvent Resistance	MIL-STD-202, Method 215
Moisture Sensitivity	Level 1, J-STD-020

Lead Configurations



Note: MOVs are non-polarized passive elements

iTMOV[®] Varistor Application Examples

The application examples below show how the indicator lead on the iTMOV[®] varistor can be used to indicate that the thermal element has been opened. This signifies that the circuit is no longer protected from transients by the MOV.

Application Example 1

In this case, the LED is normally on, and is off when the thermal element opens.

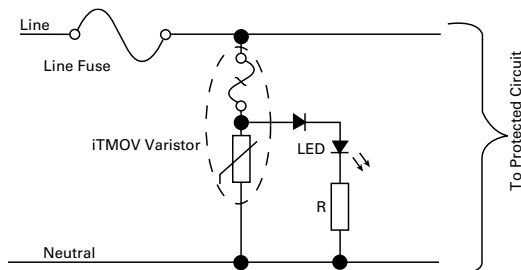

Application Example 2

This circuit utilizes an optocoupler to provide galvanic isolations between the iTMOV[®] varistor and the indicating or alarm circuitry.



Application Example 3

This circuit illustrates the use of the monitoring lead of the iTMOV[®] varistor to ensure that equipment is only operated when overvoltage protection present. In normal operation the load switch relay solenoid is powered via the indicator lead of the iTMOV[®] varistor. In the event of the thermal element being activated, the relay will de-activate, cutting power to the protected circuit and the fault LED will illuminate.



Please note: Indicator circuits are provided as a guideline only. Verification of actual indicator circuitry is the responsibility of the end user. Component values selected must be appropriate for the specific AC line voltage service and application.

Device Dimensions

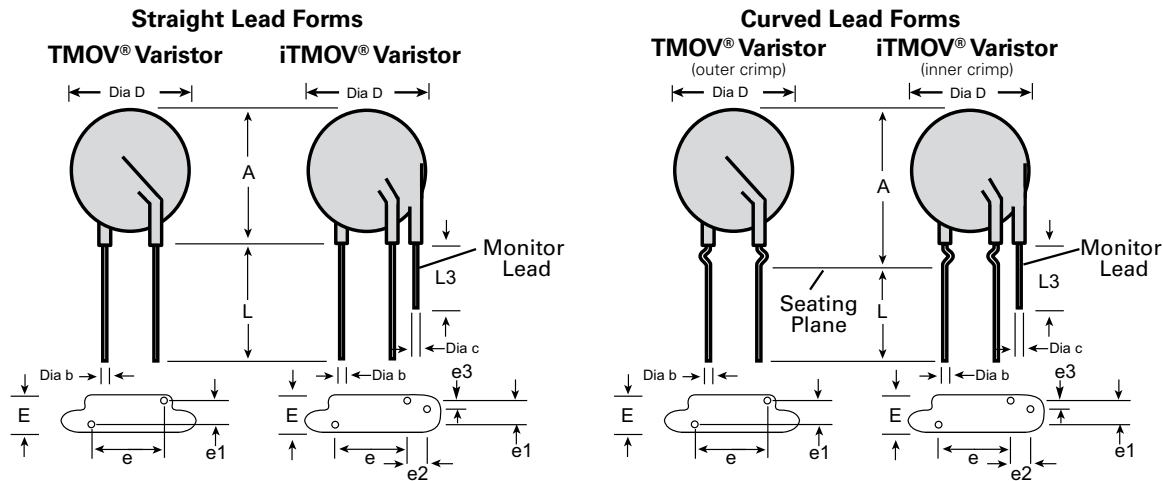

Dimension	V _{RMS} Voltage Model	TMOV® Varistor				iTMOV® Varistor			
		14mm Size		20mm Size		14mm Size		20mm Size	
		Min. mm (in)	Max. mm (in)	Min. mm (in)	Max. mm (in)	Min. mm (in)	Max. mm (in)	Min. mm (in)	Max. mm (in)
A Straight Lead	ALL	17.0 (0.669)	22.0 (0.866)	23.0 (0.906)	28.0 (1.10)	17.0 (0.669)	22.0 (0.866)	23.0 (0.906)	28.0 (1.10)
A Crimped Lead	ALL	--	22.5 (0.886)	--	31.0 (1.221)	--	22.5 (0.886)	--	31.0 (1.221)
Dia D	ALL	13.5 (0.531)	17.0 (0.669)	19.0 (0.748)	23.0 (0.906)	13.5 (0.531)	17.0 (0.669)	19.0 (0.748)	23.0 (0.906)
e	ALL	6.5 (0.256)	8.5 (0.335)	6.5 (0.256)	8.5 (0.335)	6.5 (0.256)	8.5 (0.335)	6.5 (0.256)	8.5 (0.335)
e1 Bulk Pack	115-175	1.5 (0.059)	4.0 (0.157)	1.5 (0.059)	4.0 (0.157)	1.5 (0.059)	4.0 (0.157)	1.5 (0.059)	4.0 (0.157)
	200-275	2.0 (0.079)	4.5 (0.177)	2.0 (0.079)	4.5 (0.177)	2.0 (0.079)	4.5 (0.177)	2.0 (0.079)	4.5 (0.177)
	300-420	3.0 (0.118)	5.5 (0.217)	3.0 (0.118)	5.5 (0.217)	3.0 (0.118)	5.5 (0.217)	3.0 (0.118)	5.5 (0.217)
	460-750	0	2.0 (0.079)	0	2.0 (0.079)	0	2.0 (0.079)	0	2.0 (0.079)
e1 Tape & Reel and In-Line Lead	115-420	0	2.0 (0.079)	0	2.0 (0.079)	0	2.0 (0.079)	0	2.0 (0.079)
	460-550*	0	2.0 (0.079)	0	2.0 (0.079)	0	2.0 (0.079)	0	2.0 (0.079)
e2	ALL	n/a	n/a	n/a	n/a	4.0 (0.138)	6.0 (0.236)	4.0 (0.157)	6.0 (0.236)
e3	ALL	n/a	n/a	n/a	n/a	0	2.0 (0.079)	0	2.0 (0.079)
E	115-175	--	9.0 (0.335)	--	9.0 (0.335)	--	9.0 (0.335)	--	9.0 (0.335)
	200-275	--	9.5 (0.374)	--	9.5 (0.374)	--	9.5 (0.374)	--	9.5 (0.374)
	300-460	--	11.0 (0.433)	--	11.0 (0.433)	--	11.0 (0.433)	--	11.0 (0.433)
	510-575	--	12.0 (0.472)	--	12.0 (0.472)	--	12.0 (0.472)	--	12.0 (0.472)
	625-750	--	13.0 (0.512)	--	13.0 (0.512)	--	13.0 (0.512)	--	13.0 (0.512)
L	ALL	25.4 (1.00)	--	25.4 (1.00)	--	25.4 (1.00)	--	25.4 (1.00)	--
L3	ALL	n/a	n/a	n/a	n/a	6.0 (0.236)	--	6.0 (0.236)	--
Dia b	115-420	0.76 (0.030)	0.86 (0.034)	0.76 (0.030)	0.86 (0.034)	0.76 (0.030)	0.86 (0.034)	0.76 (0.030)	0.86 (0.034)
	460-750	0.76 (0.030)	0.86 (0.034)	0.95 (0.037)	1.05 (0.041)	0.76 (0.030)	0.86 (0.034)	0.95 (0.037)	1.05 (0.041)
Dia c Outside Lead Only	ALL	n/a	n/a	n/a	n/a	0.76 (0.030)	0.86 (0.034)	0.76 (0.030)	0.86 (0.034)

NOTES:

* Tape and Reel packaging option is available only for devices up to 420Vrms.

Tape and Reel Specification

iTMOV[®] VARISTOR WITH INNER CRIMP



TMOV[®] VARISTOR WITH OUTER CRIMP



iTMOV[®] VARISTOR WITH STRAIGHT LEADS



TMOV[®] VARISTOR WITH STRAIGHT LEADS



	DESCRIPTION	CRIMPED LEADS		STRAIGHT LEADS	
		MODEL SIZE		MODEL SIZE	
		14mm	20mm	14mm	20mm
B₁	Component Top to Seating Plane	22.5 Max	31 Max	22.0 Max	28.0 Max
P	Pitch of Component	25.4 +/- 1.0	25.4 +/- 1.0	25.4 ±1.0	25.4 ±1.0
P₀	Feed Hole Pitch	12.7 +/- 0.2	12.7 +/- 0.2	12.7 ±0.2	12.7 ±0.2
P₁	Feed Hole Center to Pitch	8.95 +/- 0.7	8.95 +/- 0.7	8.95 ±0.7	8.95 ±0.7
P₂	Hole Center to Component Center	12.7 +/- 0.7	12.7 +/- 0.7	12.7 ±0.7	12.7 ±0.7
F	Lead to Lead Distance	75 +/- 0.8	75 +/- 0.8	75 ±0.8	75 ±0.8
Δh	Component Alignment	2.0 Max	2.0 Max	2.0 Max	2.0 Max
W	Tape Width	18.0 +1.0/-0.5	18.0 +1.0/-0.5	18.0 +1.0/-0.5	18.0 +1.0/-0.5
W₀	Hold Down Tape Width	12.0 +/- 0.3	12.0 +/- 0.3	12.0 ±0.3	12.0 ±0.3
W₁	Hole Position	9.0 +0.75/-0.50	9.0 +0.75/-0.50	9.0 +0.75/-0.5	9.0 +0.75/-0.5
W₂	Hold Down Tape Position	0.5 Max	0.5 Max	0.5 Max	0.5 Max
H	Height from Tape Centre to Component Base (non-crimped parts)	–	–	18.0 +2.0/0	18.0 +2.0/0
H₀	Seating Plane Height (crimped parts only)	16.0 +/- 0.5	16.0 +/- 0.5	–	–
H₁	Component Height	40.0 Max	46.5 Max	40.0 Max	46.5 Max
C	Crimp Length (crimped parts only)	2.6 typ	2.6 typ	–	–
D₀	Feed Hole Diameter	4.0 +/- 0.2	4.0 +/- 0.2	4.0 ±0.2	4.0 ±0.2
t	Total Tape Thickness	0.7 +/- 0.2	0.7 +/- 0.2	0.7 ±0.2	0.7 ±0.2
L	Length of Clipped Lead	11.0 Max	11.0 Max	11.0 Max	11.0 Max
Δp	Component Alignment	3 Max, 1.00mm	3 Max	3 deg Max, 1.0mm Max	3 deg Max, 1.0mm Max

NOTES:

- Dimensions in mm
- Reel capacity varies with voltage.
- Leads are crimped and in-line. This excludes the monitor lead on iTMOV[®] varistor which are not crimped and not in-line.
- To order tape and reel option please add suffix 'L2T7' to end of standard part number.
- Tape and reel option is available for rated voltages up to 420V. Contact factory regarding availability of higher voltages.
- Contact Littelfuse for additional details.

Part Numbering System

Base Part Codes
(See ratings & specifications tables and notes below)

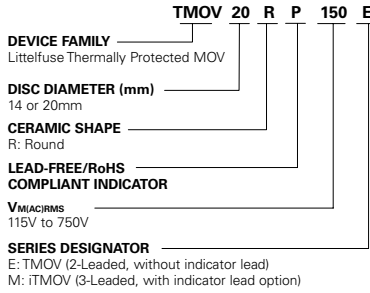

Option Codes¹
(See below)

XXXXX
NON-STANDARD LEAD FORM, PACKAGING and LEAD SPACING OPTIONS¹:

L2B7: Lead Form: Crimped and In-Line² Leads
Packaging: Bulk Pack
Lead Spacing³: 7.5mm

L2T7: Lead Form: Crimped and In-Line² Leads
Packaging: Tape and Reel⁴
Lead Spacing³: 7.5mm

L3T7: Lead Form: Straight Leads and In-Line² Leads
Packaging: Tape and Reel
Lead Spacing: 7.5mm

Option Codes:
X2855: Nickel Barrier coated wire option –
All standard parts use tinned copper clad steel wire. Nickel Barrier coated wire is available as an option, consisting of Copper wire with a flashing of Nickel followed by a top coating of Tin. To order append standard model BASE PART number with "X2855." Example:

Standard Model	Order As
TMOV20RP115E	TMOV20RP115EX2855

Other non-standard options may be available - please contact Littelfuse.

NOTES:

- Use Base Part Code only to receive standard product:
Lead Form: Straight Leads. Devices greater than 420Vrms are provided In-Line².
Packaging: Bulk Pack
Lead Spacing: 7.5mm +/-1.0mm
- "In-Line" refers to straight row of leads at the tip where product is to contact the circuit board. Refer to "e1" in Device Dimensions section.
- Lead Spacing refers to span between leads as "e" dimension in Device Dimensions section.
- Due to device bulk, tape and reel packaging option is available only for devices up to 420Vrms.

Pack Quantities

Rated Voltage	Pack Quantities			
	Bulk Pack		Tape and Reel	
	Model Size		Model Size	
	14mm	20mm	14mm	20mm
115-250	600	400	500	400
275-550	500	300	400	300
575-750	400	200	n/a	n/a

NOTE: Tape and Reel available up to 420V only - please contact factory regarding availability of higher voltage parts.

Компания «Океан Электроники» предлагает заключение долгосрочных отношений при поставках импортных электронных компонентов на взаимовыгодных условиях!

Наши преимущества:

- Поставка оригинальных импортных электронных компонентов напрямую с производств Америки, Европы и Азии, а так же с крупнейших складов мира;
- Широкая линейка поставок активных и пассивных импортных электронных компонентов (более 30 млн. наименований);
- Поставка сложных, дефицитных, либо снятых с производства позиций;
- Оперативные сроки поставки под заказ (от 5 рабочих дней);
- Экспресс доставка в любую точку России;
- Помощь Конструкторского Отдела и консультации квалифицированных инженеров;
- Техническая поддержка проекта, помощь в подборе аналогов, поставка прототипов;
- Поставка электронных компонентов под контролем ВП;
- Система менеджмента качества сертифицирована по Международному стандарту ISO 9001;
- При необходимости вся продукция военного и аэрокосмического назначения проходит испытания и сертификацию в лаборатории (по согласованию с заказчиком);
- Поставка специализированных компонентов военного и аэрокосмического уровня качества (Xilinx, Altera, Analog Devices, Intersil, Interpoint, Microsemi, Actel, Aeroflex, Peregrine, VPT, Syfer, Eurofarad, Texas Instruments, MS Kennedy, Miteq, Cobham, E2V, MA-COM, Hittite, Mini-Circuits, General Dynamics и др.);

Компания «Океан Электроники» является официальным дистрибьютором и эксклюзивным представителем в России одного из крупнейших производителей разъемов военного и аэрокосмического назначения «JONHON», а так же официальным дистрибьютором и эксклюзивным представителем в России производителя высокотехнологичных и надежных решений для передачи СВЧ сигналов «FORSTAR».



JONHON

«JONHON» (основан в 1970 г.)

Разъемы специального, военного и аэрокосмического назначения:

(Применяются в военной, авиационной, аэрокосмической, морской, железнодорожной, горно- и нефтедобывающей отраслях промышленности)

«FORSTAR» (основан в 1998 г.)

ВЧ соединители, коаксиальные кабели, кабельные сборки и микроволновые компоненты:

(Применяются в телекоммуникациях гражданского и специального назначения, в средствах связи, РЛС, а так же военной, авиационной и аэрокосмической отраслях промышленности).



Телефон: 8 (812) 309-75-97 (многоканальный)

Факс: 8 (812) 320-03-32

Электронная почта: ocean@oceanchips.ru

Web: <http://oceanchips.ru/>

Адрес: 198099, г. Санкт-Петербург, ул. Калинина, д. 2, корп. 4, лит. А