

3-INPUT / 2-INPUT VIDEO SWITCH

■ GENERAL DESCRIPTION

The **NJM2508** is video switch for video and audio signal. It contains 3 input-1 output and 2 input-1 output video switch. One input terminal has clamp function and so is applied to fixed DC level of video signal. Its operating voltage is 4.75 to 13V and bandwidth is 10MHz. Crosstalk is 75dB (at $f = 4.43\text{MHz}$)

■ PACKAGE OUTLINE

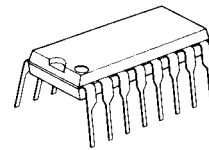

NJM2508D

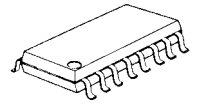

NJM2508M

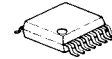

NJM2508V

■ FEATURES

- Operating Voltage (+4.75V to +13V)
- 3 Input-1 Output and 2 Input-1 Output
- Crosstalk 75dB (at 4.43MHz)
- Wide Frequency Range 10MHz (2V_{P-P} Input)
- Package Outline DIP16, DMP16, SSOP16
- Bipolar Technology

■ RECOMMENDED OPERATING CONDITION

- Operating Voltage V^+ 4.75V to 13.0V

■ APPLICATION

- VCR, Video Camera, AV-TV, Video Disk Player.

■ BLOCK DIAGRAM

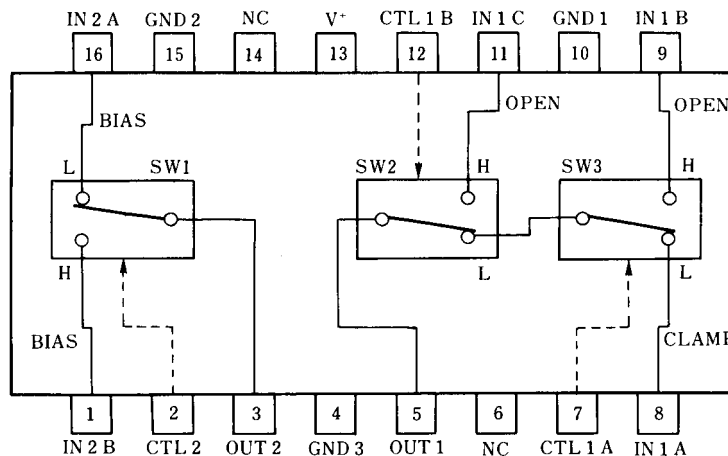

NJM2508D
NJM2508M
NJM2508V

NJM2508

■ ABSOLUTE MAXIMUM RATINGS

($T_a = 25^\circ\text{C}$)

PARAMETER	SYMBOL	RATINGS	UNIT
Supply Voltage	V^+	14	V
Power Dissipation	P_D	(DIP16) 700 (DMP16) 350 (SSOP16) 300	mW mW mW
Operating Temperature Range	T_{opr}	-40 to +85	$^\circ\text{C}$
Storage Temperature Range	T_{stg}	-40 to +125	$^\circ\text{C}$

■ ELECTRICAL CHARACTERISTICS

($V^+ = 5\text{V}$, $T_a = 25^\circ\text{C}$)

PARAMETER	SYMBOL	TEST CONDITION	MIN.	TYP.	MAX.	UNIT
Operating Current 1	I_{CC1}	$V^+ = 5\text{V}$ (Note1)	6.6	9.4	12.3	mA
Operating Current 2	I_{CC2}	$V^+ = 9\text{V}$ (Note1)	8.0	11.5	15.0	mA
Voltage Gain	G_V	$V_I = 2V_{P.P.} / 100\text{kHz}$, V_O / V_I	-0.6	-0.1	+0.4	dB
Frequency Response	G_f	$V_I = 2V_{P.P.}$, V_O (10MHz / 100kHz)	-1.0	0	+1.0	dB
Differential Gain	DG	$V_I = 2V_{P.P.}$, Staircase Signal	-	0.3	-	%
Differential Phase	DP	$V_I = 2V_{P.P.}$, Staircase Signal	-	0.3	-	deg
Output offset Voltage	V_{OS}	(Note2)	-10	0	+10	mV
Crosstalk	CT	$V_I = 2V_{P.P.}$, 4.43MHz, V_O / V_I	-	-75	-	dB
Switch Change Voltage	V_{CH}	All inside SW : ON	2.5	-	-	V
Switch Change Voltage	V_{CL}	All inside SW : OFF	-	-	1.0	V

(Note1) $S1 = S2 = S3 = S4 = S5 = S6 = S7 = 1$

(Note2) Output DC Voltage Difference is tested on $S6 = 1 \rightarrow 2$, $S1 = S2 = S3 = S4 = S5 = 1$, $S8 = 2$ and $S7 = 1$

■ TEST CIRCUIT

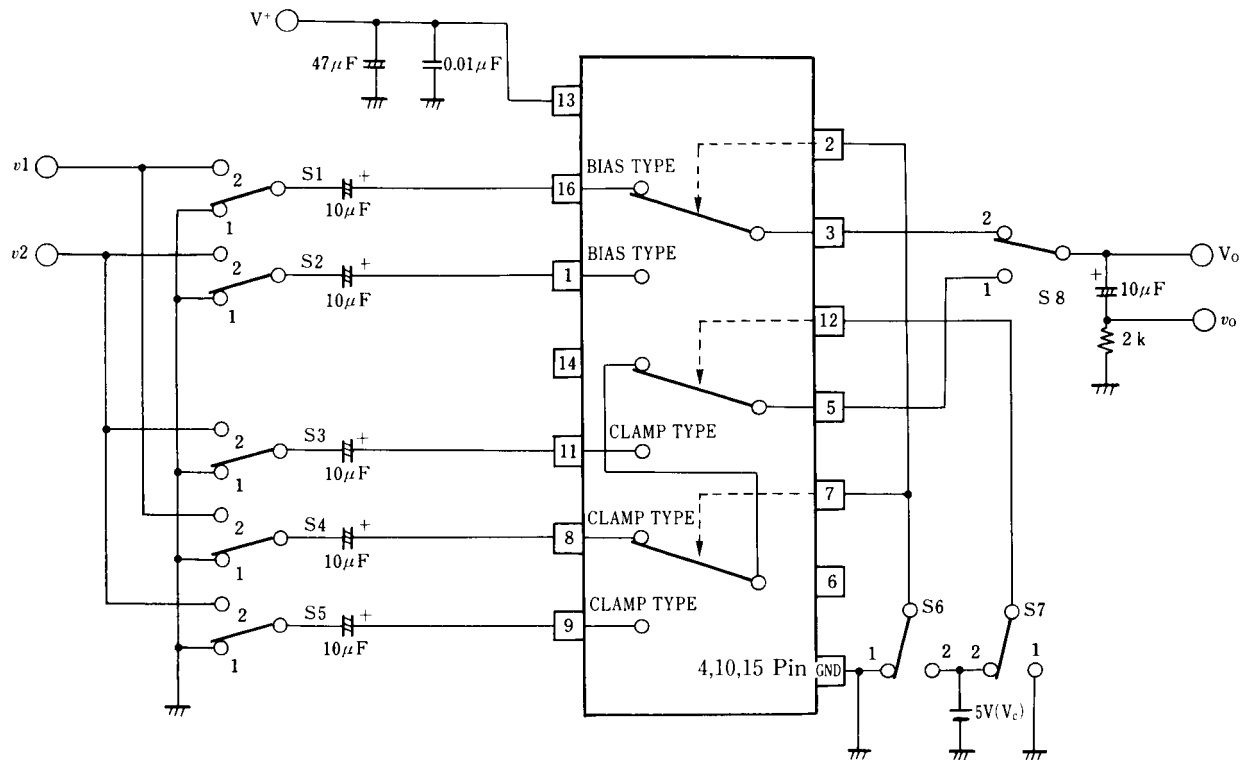

■ PIN FUNCTION

PIN No.	PIN NAME	DC VOLTAGE	INSIDE EQUIVALENT CIRCUIT
16 1	IN 2 A IN 2 B [Input]	2.5V	
8	IN 1 A [Input]	1.5V	
9 11	IN 1 B IN 1 C [Input]		
7 12 2	CTL 1 A CTL 1 B CTL 2 [Control]		
5	OUT1 [Output]	1.8V	
3	OUT2 [Output]	0.8V	
13	V ⁺	5V	
15 4 10	GND 1 GND 2 GND 3		

■ TYPICAL CHARACTERISTICS (Ta = +25°C)

Operating Current vs. Operating Voltage

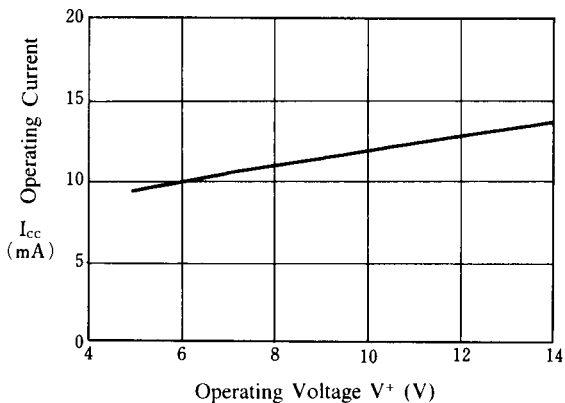

Operating Current vs. Ambient Temperature

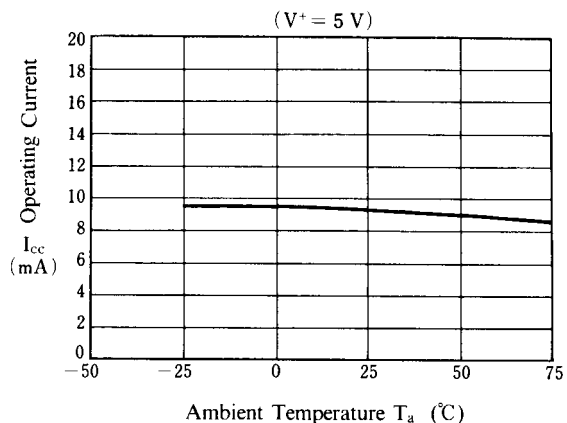

Operating Current vs. Ambient Temperature

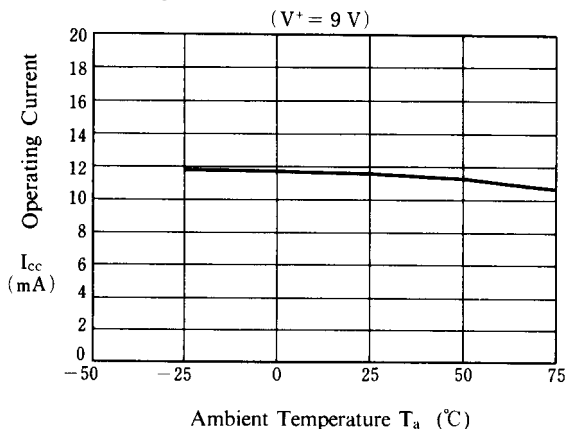

Voltage Gain vs. Operating Voltage

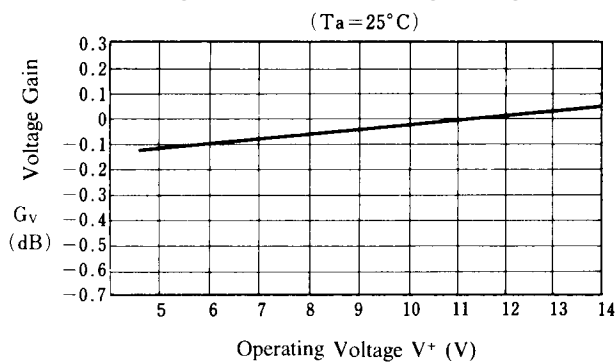

Voltage Gain vs. Frequency

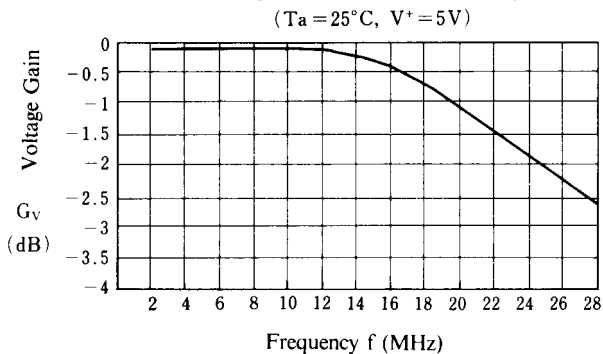

Voltage Gain vs. Ambient Temperature

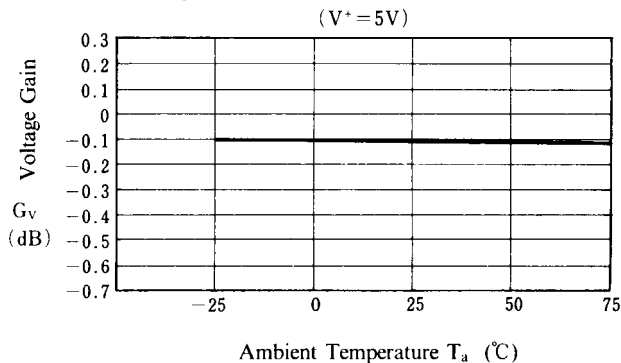

■ TYPICAL CHARACTERISTICS (Ta = +25°C)

Frequency Response vs. Operating Voltage

(Ta = 25°C)

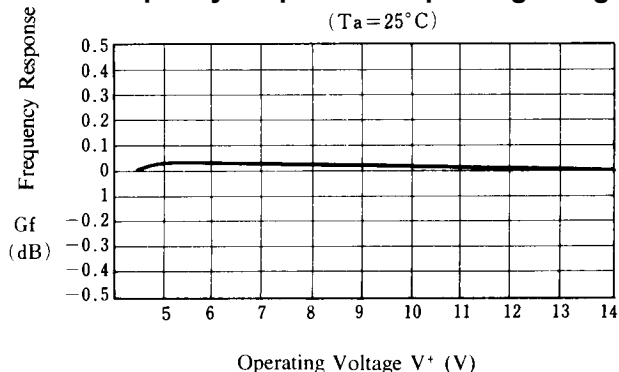

Frequency Response vs. Ambient Temperature

(V⁺ = 5V)

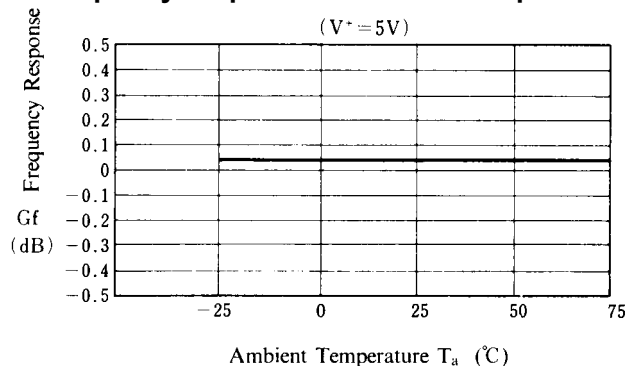

Offset Voltage vs. Operating Voltage

(Ta = 25°C)

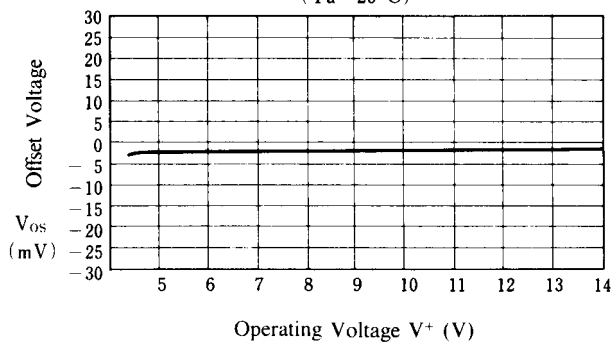

Offset Voltage vs. Ambient Temperature

(V⁺ = 5V)

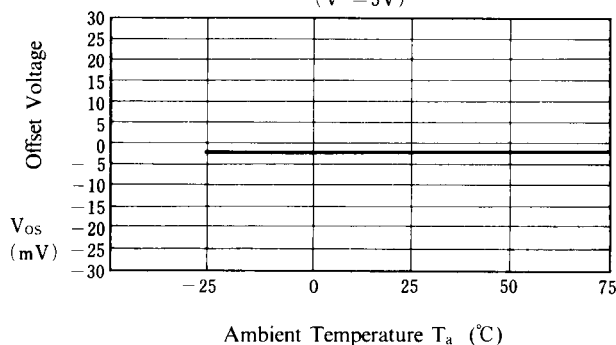

Switch Change Voltage vs. Operating Voltage

(Ta = 25°C)

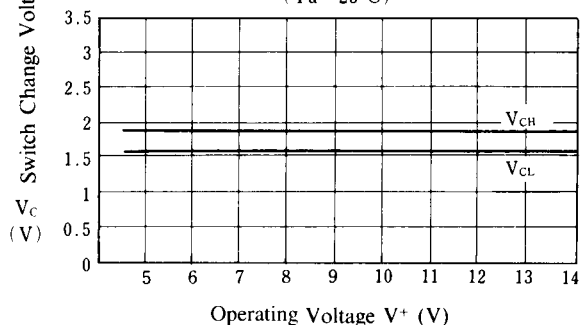

Switch Change Voltage vs. Ambient Temperature

(V⁺ = 5V)

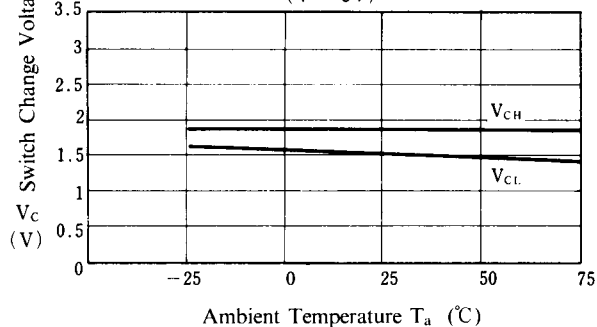

■ TYPICAL CHARACTERISTICS (Ta = +25°C)

Differential Gain vs. Operating Voltage

(Ta = 25°C)

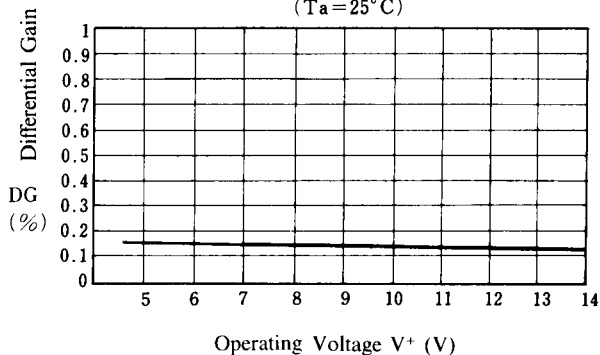

Differential Phase vs. Operating Voltage

(Ta = 25°C)

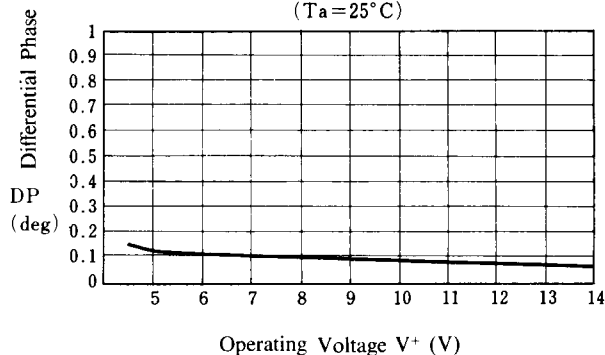

Differential Gain vs. Ambient Temperature

(V+ = 5V)

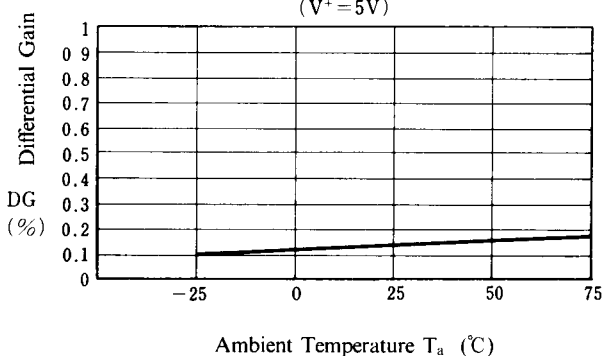

Differential Phase vs. Ambient Temperature

(V+ = 5V)

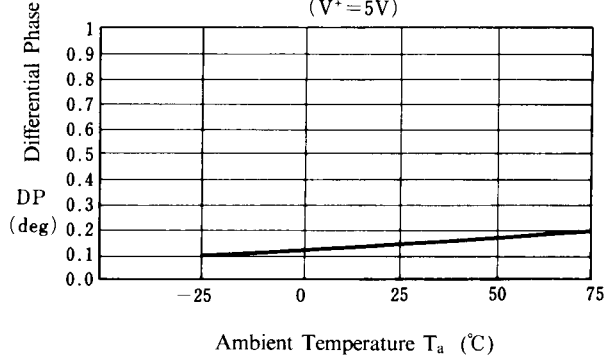

Differential Gain vs. Load

(Ta = 25°C, V+ = 5V)

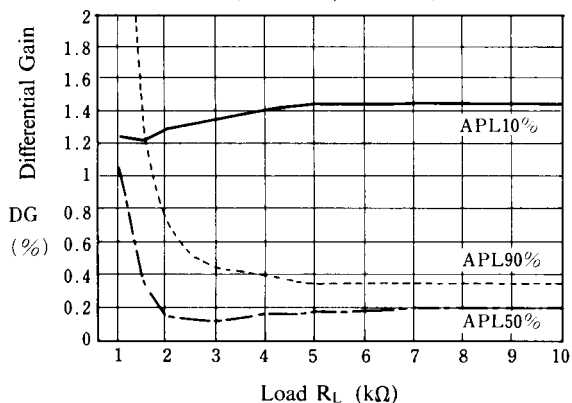

Differential Phase vs. Load

(Ta = 25°C, V+ = 5V)

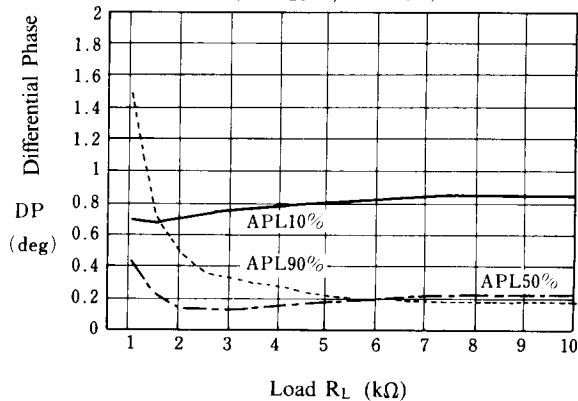

■ TYPICAL CHARACTERISTICS (Ta = +25°C)

Differential Gain vs. APL

(Ta = 25°C, V+ = 5V)

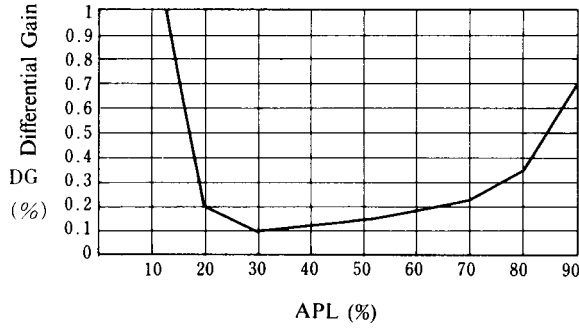

Differential Phase vs. APL

(Ta = 25°C, V+ = 5V)

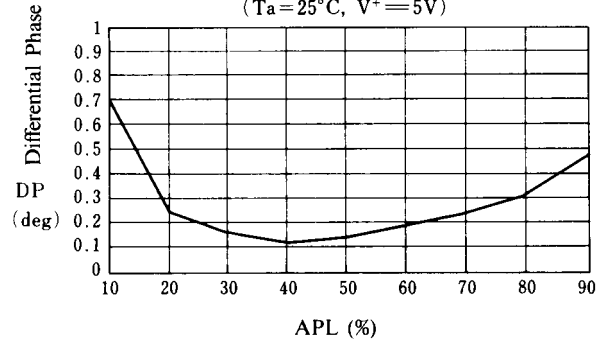

Differential Gain vs. Load

(Ta = 25°C, V+ = 5V)

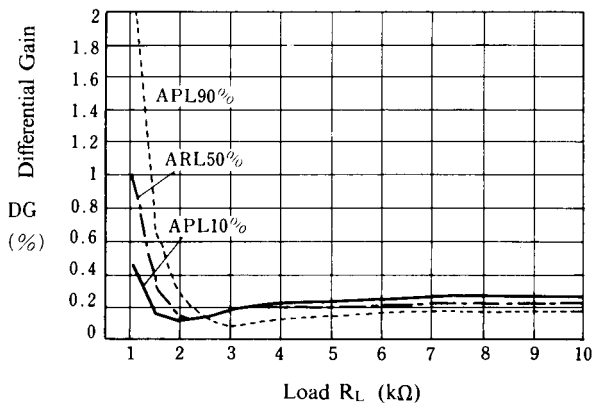

Differential Phase vs. Load

(Ta = 25°C, V+ = 5V)

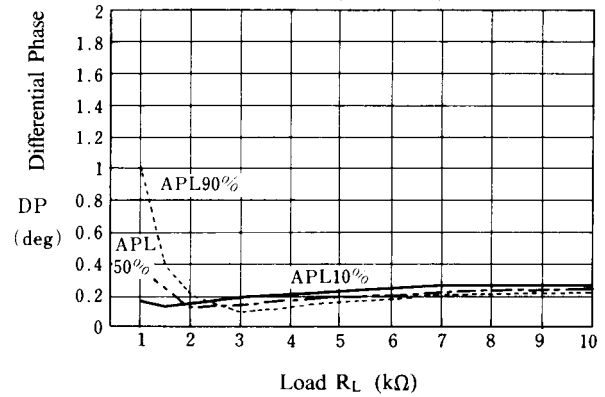

Differential Gain vs. APL

(Ta = 25°C, V+ = 5V)

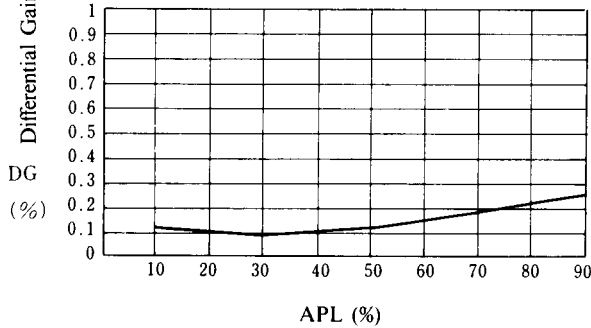

Differential Phase vs. APL

(Ta = 25°C, V+ = 5V)

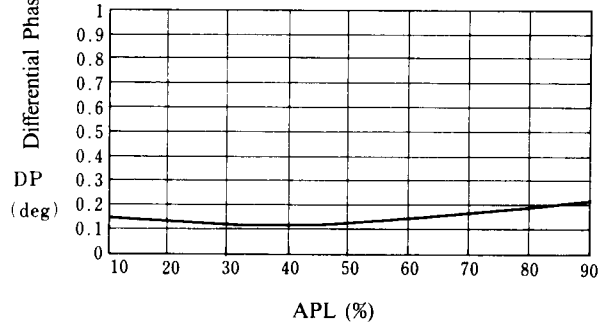

■ TYPICAL CHARACTERISTICS (Ta = +25°C)

Crosstalk vs. Operating Voltage

(Ta = 25°C)

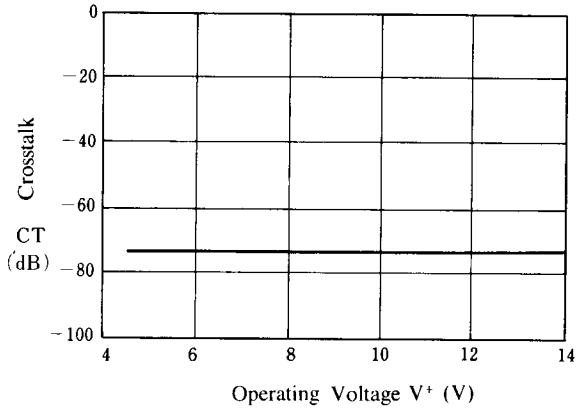

Crosstalk vs. Temperature

(V+ = 5V)

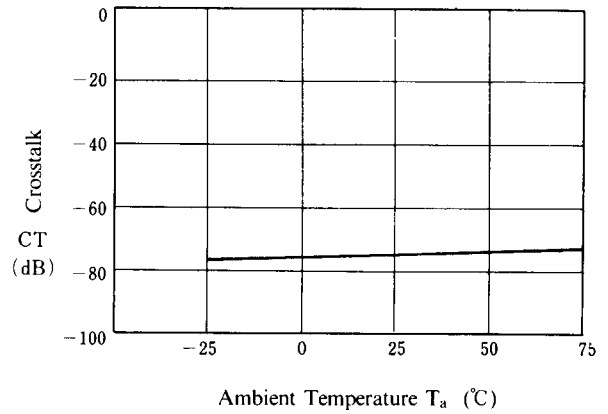

Crosstalk vs. Operating Voltage

(Ta = 25°C)

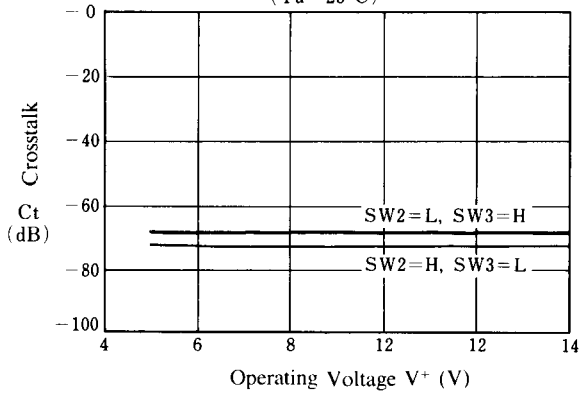

Crosstalk vs. Ambient Temperature

(V+ = 5V)

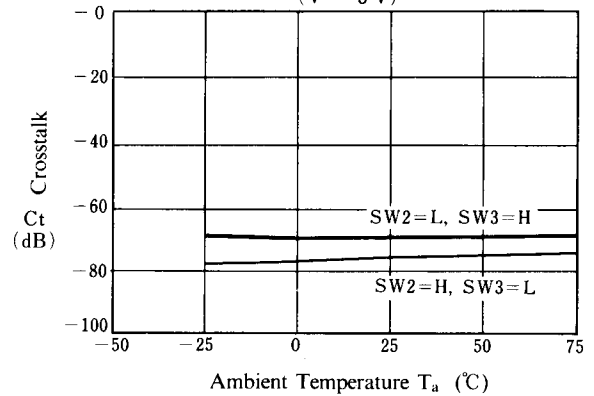

Crosstalk vs. Operating Voltage

(Ta = 25°C)

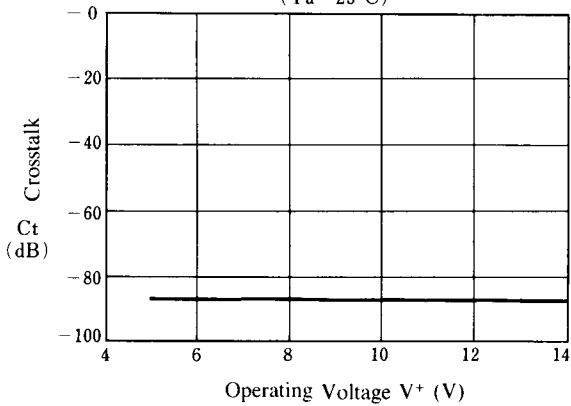

Crosstalk vs. Ambient Temperature

(V+ = 5V)

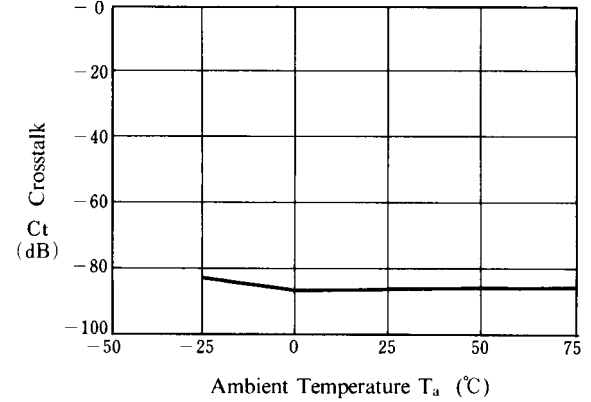

■ TYPICAL CHARACTERISTICS (T_a = +25°C)

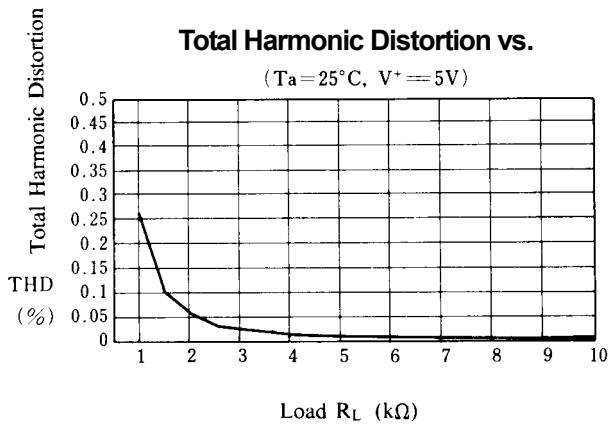

NJM2508

■ APPLICATION

This IC requires $1M\Omega$ resistance between INPUT and GND pin for clamp type input since the minute current causes an unstable pin voltage.

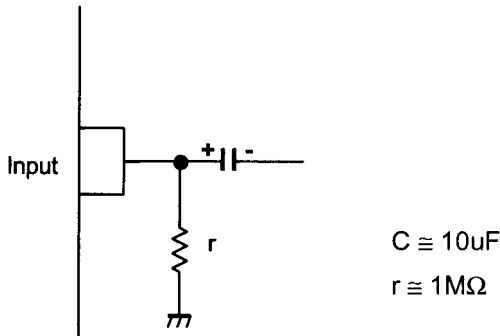

This IC requires $0.1\mu\text{F}$ capacitor between INPUT and GND, $1M\Omega$ resistance between INPUT and GND for clamp type input at mute mode.

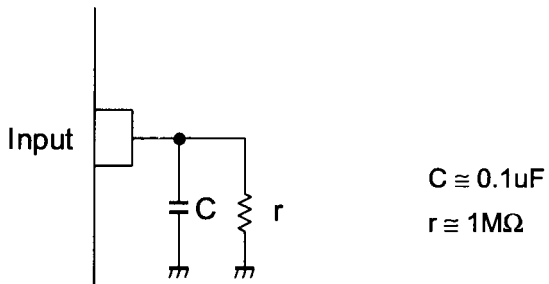

This IC requires $0.1\mu\text{F}$ capacitor between INPUT and GND for bias type input at mute mode.

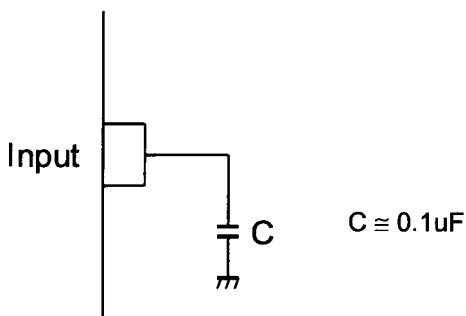

[CAUTION]
The specifications on this databook are only given for information, without any guarantee as regards either mistakes or omissions. The application circuits in this databook are described only to show representative usages of the product and not intended for the guarantee or permission of any right including the industrial rights.

Компания «Океан Электроники» предлагает заключение долгосрочных отношений при поставках импортных электронных компонентов на взаимовыгодных условиях!

Наши преимущества:

- Поставка оригинальных импортных электронных компонентов напрямую с производств Америки, Европы и Азии, а так же с крупнейших складов мира;
- Широкая линейка поставок активных и пассивных импортных электронных компонентов (более 30 млн. наименований);
- Поставка сложных, дефицитных, либо снятых с производства позиций;
- Оперативные сроки поставки под заказ (от 5 рабочих дней);
- Экспресс доставка в любую точку России;
- Помощь Конструкторского Отдела и консультации квалифицированных инженеров;
- Техническая поддержка проекта, помощь в подборе аналогов, поставка прототипов;
- Поставка электронных компонентов под контролем ВП;
- Система менеджмента качества сертифицирована по Международному стандарту ISO 9001;
- При необходимости вся продукция военного и аэрокосмического назначения проходит испытания и сертификацию в лаборатории (по согласованию с заказчиком);
- Поставка специализированных компонентов военного и аэрокосмического уровня качества (Xilinx, Altera, Analog Devices, Intersil, Interpoint, Microsemi, Actel, Aeroflex, Peregrine, VPT, Syfer, Eurofarad, Texas Instruments, MS Kennedy, Miteq, Cobham, E2V, MA-COM, Hittite, Mini-Circuits, General Dynamics и др.);

Компания «Океан Электроники» является официальным дистрибьютором и эксклюзивным представителем в России одного из крупнейших производителей разъемов военного и аэрокосмического назначения «JONHON», а так же официальным дистрибьютором и эксклюзивным представителем в России производителя высокотехнологичных и надежных решений для передачи СВЧ сигналов «FORSTAR».



JONHON

«JONHON» (основан в 1970 г.)

Разъемы специального, военного и аэрокосмического назначения:

(Применяются в военной, авиационной, аэрокосмической, морской, железнодорожной, горно- и нефтедобывающей отраслях промышленности)

«FORSTAR» (основан в 1998 г.)

ВЧ соединители, коаксиальные кабели,
кабельные сборки и микроволновые компоненты:

(Применяются в телекоммуникациях гражданского и специального назначения, в средствах связи, РЛС, а так же военной, авиационной и аэрокосмической отраслях промышленности).



Телефон: 8 (812) 309-75-97 (многоканальный)

Факс: 8 (812) 320-03-32

Электронная почта: ocean@oceanchips.ru

Web: <http://oceanchips.ru/>

Адрес: 198099, г. Санкт-Петербург, ул. Калинина, д. 2, корп. 4, лит. А