



# Nanopower $\mu$ P Supervisory Circuits with Manual Reset and Watchdog Timer

## General Description

The MAX6854/MAX6855/MAX6856/MAX6858/MAX6860–MAX6869 ultra-low-current (170nA, typ) microprocessor ( $\mu$ P) supervisory circuits combine voltage monitoring, watchdog timer, and manual reset input functions in a 5-pin SOT23 package. These devices assert a reset signal whenever the monitored voltage drops below the factory-trimmed reset threshold voltage, manual reset is asserted, or the watchdog timer expires. The reset output remains asserted for a minimum timeout period after  $V_{CC}$  rises above the reset threshold and manual reset is deasserted. Factory-trimmed reset threshold voltages are offered from +1.575V to +4.625V in approximately 100mV increments (see the *Threshold Suffix Guide*). Each device is offered with six minimum reset timeout options, ranging from 10ms to 1200ms.

The MAX6854/MAX6855/MAX6856/MAX6858/MAX6860–MAX6869 are offered in a variety of configurations (see the *Selector Guide*). The MAX6854/MAX6855/MAX6856/MAX6861–MAX6869 provide a manual reset input, MR. The MAX6864–MAX6869 offer a watchdog timer that monitors activity at the WDI input to prevent code execution errors. The MAX6864–MAX6869 offer watchdog timeout options of 3.3s or 209s (typ). The MAX6861/MAX6862/MAX6863 feature a pin-selectable reset delay period of 10ms or 150ms (min). Push-pull active-low, push-pull active-high, and open-drain active-low reset outputs are available.

## Applications

Portable/Battery-Powered Equipment  
PDA's/Cell Phones  
MP3 Players/Pagers  
Glucose Monitors/Patient Monitors

## Typical Operating Circuit



## Features

- ◆ Ultra-Low 170nA (typ) Supply Current
- ◆ Reset Thresholds from +1.575V to +4.625V in Approximately 100mV Increments
- ◆ Six Minimum Reset Timeout Period Options from 10ms to 1200ms
- ◆ Manual Reset Option
- ◆ Watchdog Timer Option
- ◆ Pin-Selectable 10ms/150ms (min) Reset Timeout Period (MAX6861/MAX6862/MAX6863)
- ◆ Immune to Short  $V_{CC}$  Transients
- ◆ Guaranteed Reset Valid to  $V_{CC} = +1.1V$
- ◆ Three Reset Output Options:
  - Push-Pull RESET
  - Push-Pull RESET
  - Open-Drain RESET
- ◆ No External Components
- ◆ Small 5-Pin SOT23 Package
- ◆ Pin Compatible to the TPS3836/TPS3837/TPS3838 (MAX6861/MAX6862/MAX6863)

## Ordering Information

PART <sup>†</sup>	TEMP RANGE	PIN-PACKAGE
MAX6854UK_ _D_-T	-40°C to +85°C	5 SOT23-5
MAX6855UK_ _D_-T	-40°C to +85°C	5 SOT23-5

<sup>†</sup>Insert reset threshold suffix (see Table 2, *Threshold Suffix Guide*) after UK. Insert the number corresponding to the desired reset timeout period (see Table 4, *Reset Timeout Period*) after D.

**Note:** Sample stock is generally held on standard versions only (see Table 5, *Standard Versions Table*). Standard versions have an order increment of 2500 pieces. Nonstandard versions have an order increment of 10,000 pieces. Contact factory for availability of nonstandard versions.

Devices are available in both leaded and lead-free packaging. Specify lead-free by replacing "-T" with "+T" when ordering.

*Pin Configurations and Selector Guide appear at end of data sheet.*

*Ordering Information continued at end of data sheet.*



# Nanopower $\mu$ P Supervisory Circuits with Manual Reset and Watchdog Timer

## ABSOLUTE MAXIMUM RATINGS

$V_{CC}$ , Open-Drain  $\overline{RESET}$  to GND .....-0.3V to +6.0V  
 MR, Push-Pull  $\overline{RESET}$ ,  $\overline{RESET}$ ,  
 WDI, CT, I.C.....-0.3V to ( $V_{CC}$  + 0.3V)  
 Input Current, Output Current (all pins)..... $\pm$ 20mA  
 Continuous Power Dissipation ( $T_A$  = +70°C)  
 5-Pin SOT23 (derate 7.1mW/°C above +70°C).....571mW

Operating Temperature Range .....-40°C to +85°C  
 Junction Temperature .....+150°C  
 Storage Temperature Range .....-65°C to +150°C  
 Lead Temperature (soldering, 10s) .....+300°C

Stresses beyond those listed under "Absolute Maximum Ratings" may cause permanent damage to the device. These are stress ratings only, and functional operation of the device at these or any other conditions beyond those indicated in the operational sections of the specifications is not implied. Exposure to absolute maximum rating conditions for extended periods may affect device reliability.

## ELECTRICAL CHARACTERISTICS

( $V_{CC}$  = 1.2V to 5.5V,  $T_A$  = -40°C to +85°C, unless otherwise specified. Typical values are at  $V_{CC}$  = 2.5V,  $T_A$  = +25°C.) (Note 1)

PARAMETER	SYMBOL	CONDITIONS		MIN	TYP	MAX	UNITS
Supply Voltage	$V_{CC}$	$T_A \geq 0^\circ\text{C}$		1.1		5.5	V
		$T_A = -40^\circ\text{C}$ to $+85^\circ\text{C}$		1.2		5.5	
Supply Current	$I_{CC}$	$V_{CC} > V_{TH}$ , no load, reset output deasserted (Note 2)	$V_{CC} = 5.0\text{V}$		210	400	nA
			$V_{CC} = 3.3\text{V}$		190	380	
			$V_{CC} = 1.8\text{V}$		170	370	
		$V_{CC} < V_{TH}$ , no load, reset output asserted			7	15	$\mu\text{A}$
$V_{CC}$ Reset Threshold	$V_{TH}$	$V_{CC}$ falling (see Table 2)		$V_{TH} - 2.5\%$	$V_{TH}$	$V_{TH} + 2.5\%$	V
Reset Threshold Hysteresis	$V_{HYST}$	Reset asserted to reset deasserted			0.5		% $V_{TH}$
Reset Timeout Period	$t_{RP}$	$V_{CC} = V_{TH} + 150\text{mV}$ (Figures 2 and 3)	D1	10	15	25	ms
			D2	40	60	80	
			D3	150	225	300	
			D4	1200	1800	2400	
			D5	300	450	600	
			D6	600	900	1200	
$V_{CC}$ to Reset Delay	$t_{RD}$	$V_{CC}$ falling from ( $V_{TH} + 100\text{mV}$ ) to ( $V_{TH} - 100\text{mV}$ ) at $10\text{mV}/\mu\text{s}$			40		$\mu\text{s}$
$\overline{RESET}$ Output Voltage	$V_{OL}$	$V_{CC} \geq 1.1\text{V}$ , $I_{SINK} = 50\mu\text{A}$ , $\overline{RESET}$ asserted, $T_A \geq 0^\circ\text{C}$				0.3	V
		$V_{CC} \geq 1.2\text{V}$ , $I_{SINK} = 100\mu\text{A}$ , $\overline{RESET}$ asserted				0.3	
		$V_{CC} \geq 2.12\text{V}$ , $I_{SINK} = 1.2\text{mA}$ , $\overline{RESET}$ asserted				0.3	
	$V_{OH}$	$V_{CC} \geq 1.71\text{V}$ , $I_{SOURCE} = 200\mu\text{A}$ , $\overline{RESET}$ deasserted, push-pull $\overline{RESET}$ only		$0.8 \times V_{CC}$			
$V_{CC} \geq 2.38\text{V}$ , $I_{SOURCE} = 500\mu\text{A}$ , $\overline{RESET}$ deasserted, push-pull $\overline{RESET}$ only		$0.8 \times V_{CC}$					
Open-Drain $\overline{RESET}$ Leakage Current	$I_{LKG}$	$\overline{RESET}$ deasserted				25	nA

# Nanopower $\mu$ P Supervisory Circuits with Manual Reset and Watchdog Timer

## ELECTRICAL CHARACTERISTICS (continued)

( $V_{CC} = 1.2V$  to  $5.5V$ ,  $T_A = -40^{\circ}C$  to  $+85^{\circ}C$ , unless otherwise specified. Typical values are at  $V_{CC} = 2.5V$ ,  $T_A = +25^{\circ}C$ .) (Note 1)

PARAMETER	SYMBOL	CONDITIONS	MIN	TYP	MAX	UNITS
RESET Output Voltage	$V_{OH}$	$V_{CC} \geq 1.1V$ , $I_{SOURCE} = 10\mu A$ , RESET asserted, $T_A \geq 0^{\circ}C$	0.8 x $V_{CC}$			V
		$V_{CC} \geq 1.2V$ , $I_{SOURCE} = 10\mu A$ , RESET asserted	0.8 x $V_{CC}$			
		$V_{CC} \geq 1.53V$ , $I_{SOURCE} = 200\mu A$ , RESET asserted	0.8 x $V_{CC}$			
		$V_{CC} \geq 2.12V$ , $I_{SOURCE} = 500\mu A$ , RESET asserted	0.8 x $V_{CC}$			
	$V_{OL}$	$V_{CC} \geq 1.71V$ , $I_{SINK} = 500\mu A$ , RESET deasserted	0.3			
		$V_{CC} \geq 2.38V$ , $I_{SINK} = 1.2mA$ , RESET deasserted	0.3			
CT Input Current		CT = GND or $V_{CC}$	20			nA
CT Input Voltage	$V_{IH}$		0.8 x $V_{CC}$			V
	$V_{IL}$		0.2 x $V_{CC}$			
<b>MANUAL RESET INPUT</b>						
$\overline{MR}$ Input Voltage	$V_{IH}$		0.7 x $V_{CC}$			V
	$V_{IL}$		0.3 x $V_{CC}$			
$\overline{MR}$ Minimum Pulse Width	$t_{MPW}$		1			$\mu s$
$\overline{MR}$ Glitch Rejection			200			ns
$\overline{MR}$ to Reset Delay	$t_{MRD}$		250			ns
$\overline{MR}$ Pullup Resistance			5	10	20	$k\Omega$
<b>WATCHDOG TIMER (MAX6864–MAX6869)</b>						
WDI Input Voltage	$V_{IH}$		0.7 x $V_{CC}$			V
	$V_{IL}$		0.3 x $V_{CC}$			
WDI Input Current		WDI = GND or $V_{CC}$	20			nA
WDI Pulse Width	$t_{WDI}$	(Note 3)	150			ns
Watchdog Timeout Period	$t_{WD}$	S	1.5	3.3	7.75	s
		L	95	209	487	

**Note 1:** Devices are tested at  $T_A = +25^{\circ}C$ . Specifications for  $T_A = -40^{\circ}C$  to  $+85^{\circ}C$  are guaranteed by design.

**Note 2:** For the MAX6864–MAX6869, the watchdog period is 1s with  $t_{RISE}$  and  $t_{FALL} < 50ns$ .

**Note 3:** Guaranteed by design.

# Nanopower $\mu$ P Supervisory Circuits with Manual Reset and Watchdog Timer

## Typical Operating Characteristics

( $V_{CC} = +2.5V$ ,  $T_A = +25^\circ C$ , unless otherwise noted.)



# Nanopower $\mu$ P Supervisory Circuits with Manual Reset and Watchdog Timer

## Typical Operating Characteristics (continued)

( $V_{CC} = +2.5V$ ,  $T_A = +25^\circ C$ , unless otherwise noted.)

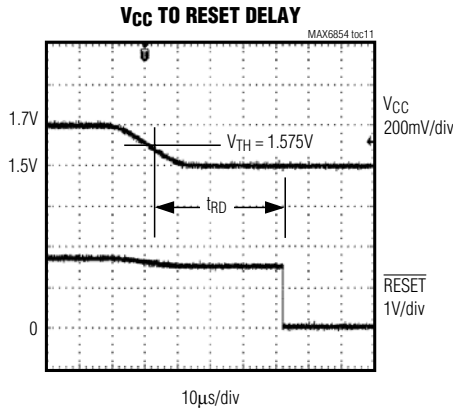
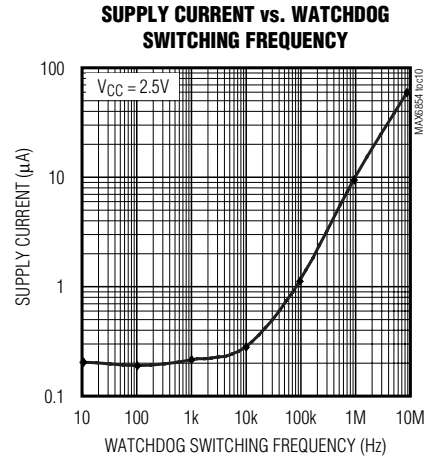
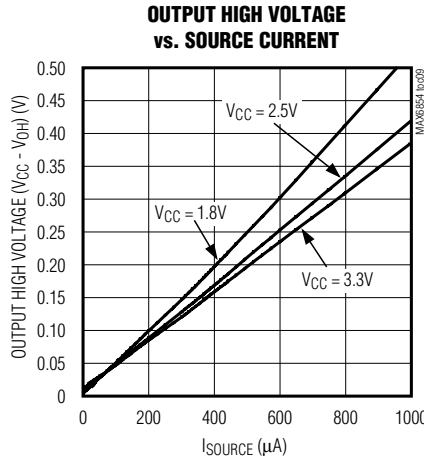
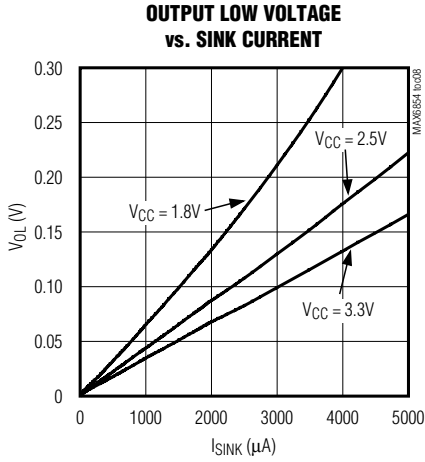

MAX6854/MAX6855/MAX6856/MAX6858/MAX6860-MAX6869

# Nanopower $\mu$ P Supervisory Circuits with Manual Reset and Watchdog Timer

## MAX6854/MAX6855/MAX6856 Pin Description

PIN		NAME	FUNCTION
MAX6854/ MAX6856	MAX6855		
1	—	$\overline{\text{RESET}}$	Active-Low Open-Drain or Push-Pull Reset Output. $\overline{\text{RESET}}$ transitions from high to low when $V_{CC}$ drops below the selected reset threshold or $\overline{\text{MR}}$ is pulled low. $\overline{\text{RESET}}$ remains low for the reset timeout period after $V_{CC}$ exceeds the device reset threshold and $\overline{\text{MR}}$ deasserts. Push-pull $\overline{\text{RESET}}$ outputs are referenced to $V_{CC}$ . Open-drain $\overline{\text{RESET}}$ outputs require an external pullup resistor.
2, 4	2, 4	GND	Ground. Connect all GND inputs to the same potential.
3	3	$\overline{\text{MR}}$	Active-Low Manual Reset Input. Drive $\overline{\text{MR}}$ low to initiate a reset. The reset output remains asserted while $\overline{\text{MR}}$ is held low and for the reset timeout period after $\overline{\text{MR}}$ transitions high. Leave $\overline{\text{MR}}$ unconnected or connect to $V_{CC}$ if unused. $\overline{\text{MR}}$ is internally pulled up to $V_{CC}$ through 10k $\Omega$ .
5	5	$V_{CC}$	Supply Voltage. Input for $V_{CC}$ reset monitor. For noisy systems, bypass $V_{CC}$ with a 0.1 $\mu$ F capacitor to GND.
—	1	RESET	Active-High Push-Pull Reset Output. RESET transitions from low to high when $V_{CC}$ drops below the selected reset threshold or $\overline{\text{MR}}$ is pulled low. RESET remains high for the reset timeout period after $V_{CC}$ exceeds the device reset threshold and $\overline{\text{MR}}$ deasserts. RESET is referenced to $V_{CC}$ .

## MAX6858/MAX6860 Pin Description

PIN	NAME	FUNCTION
MAX6858/ MAX6860		
1, 2	I.C.	Internally Connected. For increased noise immunity, connect I.C. to GND.
3	GND	Ground
4	$\overline{\text{RESET}}$	Active-Low Open-Drain or Push-Pull Reset Output. $\overline{\text{RESET}}$ transitions from high to low when $V_{CC}$ drops below the selected reset threshold. $\overline{\text{RESET}}$ remains low for the reset timeout period after $V_{CC}$ exceeds the device reset threshold. Push-pull $\overline{\text{RESET}}$ outputs are referenced to $V_{CC}$ . Open-drain $\overline{\text{RESET}}$ outputs require an external pullup resistor.
5	$V_{CC}$	Supply Voltage. Input for $V_{CC}$ reset monitor. For noisy systems, bypass $V_{CC}$ with a 0.1 $\mu$ F capacitor to GND.

# Nanopower $\mu$ P Supervisory Circuits with Manual Reset and Watchdog Timer

## MAX6861/MAX6862/MAX6863 Pin Description

PIN		NAME	FUNCTION
MAX6861/ MAX6863	MAX6862		
1	1	CT	Reset Timeout Select Input. Connect CT low to select the D1 reset timeout output period (see Tables 1 and 4). Connect CT high (normally V <sub>CC</sub> ) to select the D3 reset timeout period.
2	2	GND	Ground
3	3	$\overline{\text{MR}}$	Active-Low Manual Reset Input. Drive $\overline{\text{MR}}$ low to initiate a reset. The reset output remains asserted while $\overline{\text{MR}}$ is held low and for the reset timeout period after $\overline{\text{MR}}$ transitions high. Leave $\overline{\text{MR}}$ unconnected or connect to V <sub>CC</sub> if unused. $\overline{\text{MR}}$ is internally pulled up to V <sub>CC</sub> through 10k $\Omega$ .
4	—	$\overline{\text{RESET}}$	Active-Low Open-Drain or Push-Pull Reset Output. $\overline{\text{RESET}}$ transitions from high to low when V <sub>CC</sub> drops below the selected reset threshold or $\overline{\text{MR}}$ is pulled low. $\overline{\text{RESET}}$ remains low for the reset timeout period after V <sub>CC</sub> exceeds the device reset threshold and $\overline{\text{MR}}$ deasserts. Push-pull $\overline{\text{RESET}}$ outputs are referenced to V <sub>CC</sub> . Open-drain $\overline{\text{RESET}}$ outputs require an external pullup resistor.
5	5	V <sub>CC</sub>	Supply Voltage. Input for V <sub>CC</sub> reset monitor. For noisy systems, bypass V <sub>CC</sub> with a 0.1 $\mu$ F capacitor to GND.
—	4	RESET	Active-High Push-Pull Reset Output. RESET transitions from low to high when V <sub>CC</sub> drops below the selected reset threshold or $\overline{\text{MR}}$ is pulled low. RESET remains high for the reset timeout period after V <sub>CC</sub> exceeds the device reset threshold and $\overline{\text{MR}}$ deasserts. RESET is referenced to V <sub>CC</sub> .

MAX6854/MAX6855/MAX6856/MAX6858/MAX6860-MAX6869

# Nanopower $\mu$ P Supervisory Circuits with Manual Reset and Watchdog Timer

## MAX6864/MAX6865/MAX6866 Pin Description

PIN		NAME	FUNCTION
MAX6864/ MAX6866	MAX6865		
1	—	$\overline{\text{RESET}}$	Active-Low Open-Drain or Push-Pull Reset Output. $\overline{\text{RESET}}$ transitions from high to low when $V_{CC}$ drops below the selected reset threshold, $\overline{\text{MR}}$ is pulled low, or the watchdog timer expires. $\overline{\text{RESET}}$ remains low for the reset timeout period after $V_{CC}$ exceeds the device reset threshold, $\overline{\text{MR}}$ deasserts, or after the watchdog timer expires. Push-pull $\overline{\text{RESET}}$ outputs are referenced to $V_{CC}$ . Open-drain $\overline{\text{RESET}}$ outputs require an external pullup resistor.
2	2	GND	Ground
3	3	$\overline{\text{MR}}$	Active-Low Manual Reset Input. Drive $\overline{\text{MR}}$ low to initiate a reset. The reset output remains asserted while $\overline{\text{MR}}$ is held low and for the reset timeout period after $\overline{\text{MR}}$ transitions high. Leave $\overline{\text{MR}}$ unconnected or connect to $V_{CC}$ if unused. $\overline{\text{MR}}$ is internally pulled up to $V_{CC}$ through 10k $\Omega$ .
4	4	WDI	Watchdog Input. If WDI remains high or low for longer than the watchdog timeout period, the internal watchdog timer expires, and a reset is triggered for the reset timeout period. The internal watchdog timer clears whenever reset is asserted, the manual reset is asserted, or WDI sees a rising or falling edge.
5	5	$V_{CC}$	Supply Voltage. Input for $V_{CC}$ reset monitor. For noisy systems, bypass $V_{CC}$ with a 0.1 $\mu$ F capacitor to GND.
—	1	RESET	Active-High Push-Pull Reset Output. RESET transitions from low to high when $V_{CC}$ drops below the selected reset threshold, $\overline{\text{MR}}$ is pulled low, or the watchdog timer expires. RESET remains high for the reset timeout period after $V_{CC}$ exceeds the device reset threshold, $\overline{\text{MR}}$ deasserts, or after the watchdog timer expires. RESET is referenced to $V_{CC}$ .



# Nanopower $\mu$ P Supervisory Circuits with Manual Reset and Watchdog Timer

## MAX6867/MAX6868/MAX6869 Pin Description

PIN		NAME	FUNCTION
MAX6867/ MAX6869	MAX6868		
1	1	WDI	Watchdog Input. If WDI remains high or low for longer than the watchdog timeout period, the internal watchdog timer expires, and a reset is triggered for the reset timeout period. The internal watchdog timer clears whenever reset is asserted, the manual reset is asserted, or WDI sees a rising or falling edge.
2	2	GND	Ground
3	3	$\overline{\text{MR}}$	Active-Low Manual Reset Input. Drive $\overline{\text{MR}}$ low to initiate a reset. The reset output remains asserted while $\overline{\text{MR}}$ is held low and for the reset timeout period after $\overline{\text{MR}}$ transitions high. Leave $\overline{\text{MR}}$ unconnected or connect to $V_{\text{CC}}$ if unused. $\overline{\text{MR}}$ is internally pulled up to $V_{\text{CC}}$ through 10k $\Omega$ .
4	—	$\overline{\text{RESET}}$	Active-Low Open-Drain or Push-Pull Reset Output. $\overline{\text{RESET}}$ transitions from high to low when $V_{\text{CC}}$ drops below the selected reset threshold, $\overline{\text{MR}}$ is pulled low, or the watchdog timer expires. $\overline{\text{RESET}}$ remains low for the reset timeout period after $V_{\text{CC}}$ exceeds the device reset threshold, $\overline{\text{MR}}$ deasserts, or after the watchdog timer expires. Push-pull $\overline{\text{RESET}}$ outputs are referenced to $V_{\text{CC}}$ . Open-drain $\overline{\text{RESET}}$ outputs require an external pullup resistor.
5	5	$V_{\text{CC}}$	Supply Voltage. Input for $V_{\text{CC}}$ reset monitor. For noisy systems, bypass $V_{\text{CC}}$ with a 0.1 $\mu$ F capacitor to GND.
—	4	RESET	Active-High Push-Pull Reset Output. RESET transitions from low to high when $V_{\text{CC}}$ drops below the selected reset threshold, $\overline{\text{MR}}$ is pulled low, or the watchdog timer expires. RESET remains high for the reset timeout period after $V_{\text{CC}}$ exceeds the device reset threshold, $\overline{\text{MR}}$ deasserts, or after the watchdog timer expires. RESET is referenced to $V_{\text{CC}}$ .

MAX6854/MAX6855/MAX6856/MAX6858/MAX6860-MAX6869

# Nanopower $\mu$ P Supervisory Circuits with Manual Reset and Watchdog Timer

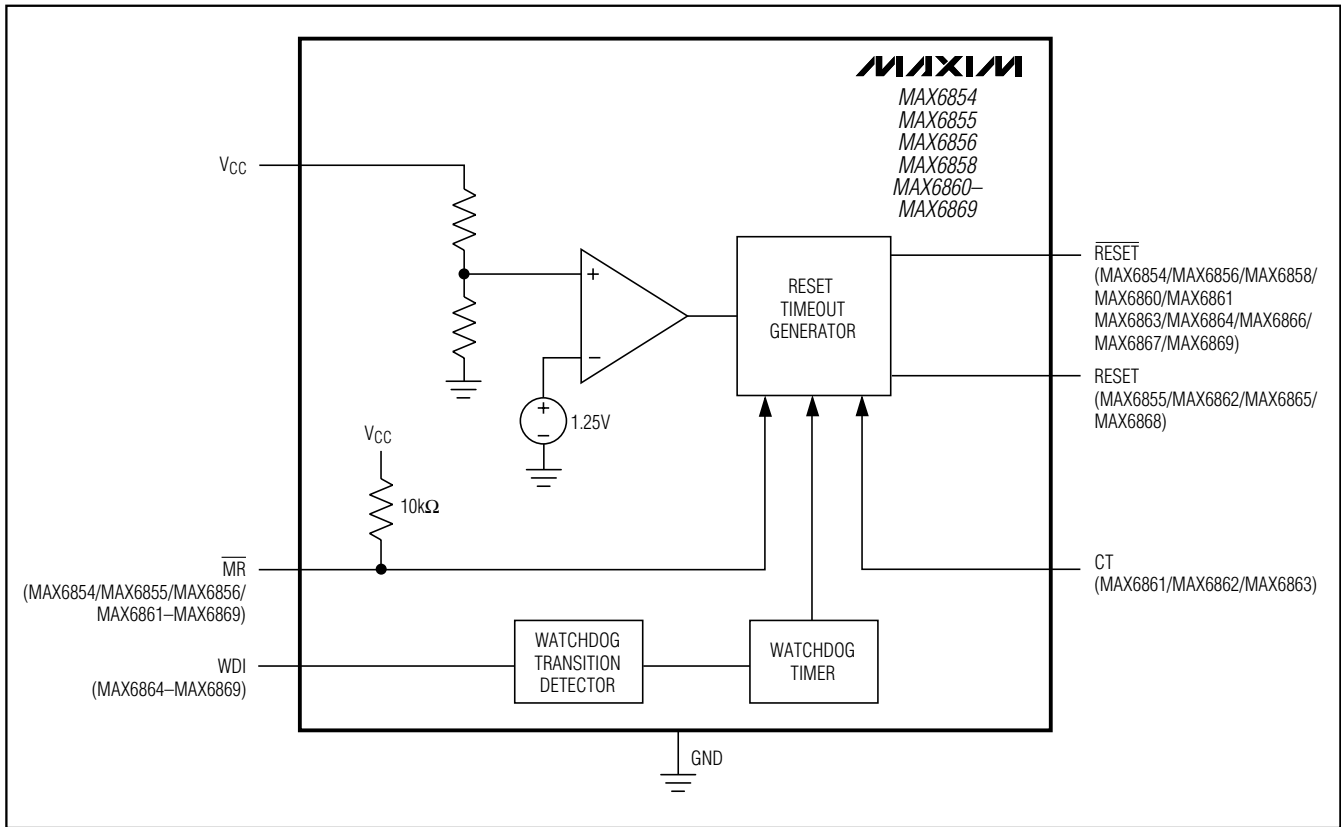

Figure 1. Functional Diagram



Figure 2. RESE Timing Relationship

# Nanopower $\mu$ P Supervisory Circuits with Manual Reset and Watchdog Timer

MAX6854/MAX6855/MAX6856/MAX6858/MAX6860-MAX6869



Figure 3. Detailed Watchdog Input Timing Relationship

## Detailed Description

### **RESET/RESET Output**

A  $\mu$ P's reset input starts the  $\mu$ P in a known state. The MAX6854/MAX6855/MAX6856/MAX6858/MAX6860-MAX6869  $\mu$ P supervisory circuits assert a reset to prevent code-execution errors during power-up, power-down, and brownout conditions. The MAX6854/MAX6855/MAX6856/MAX6858/MAX6860-MAX6869 reset output is guaranteed to be valid for  $V_{CC}$  down to 1.1V.

Whenever  $V_{CC}$  falls below the reset threshold, the reset output asserts low for  $\overline{\text{RESET}}$  and high for  $\text{RESET}$ . Once  $V_{CC}$  exceeds the reset threshold, an internal timer keeps the reset output asserted for the specified reset timeout period, then after this interval the reset output deasserts (see Figure 2).

### **Manual Reset Input**

Many  $\mu$ P-based products require manual reset capability, allowing the operator, a test technician, or external logic circuitry to initiate a reset. The MAX6854/MAX6855/MAX6856/MAX6861-MAX6869 feature an  $\overline{\text{MR}}$  input. A logic low on  $\overline{\text{MR}}$  asserts a reset. Reset remains asserted while  $\overline{\text{MR}}$  is low and for the timeout period,  $t_{RP}$ , after  $\overline{\text{MR}}$  returns high. The devices provide an internal  $10\text{k}\Omega$  pullup from  $\overline{\text{MR}}$  to  $V_{CC}$ . Leave  $\overline{\text{MR}}$  unconnected or connect to  $V_{CC}$  if unused.  $\overline{\text{MR}}$  can be driven with CMOS logic levels or with open-drain/collector outputs. Connect a normally open momentary switch from  $\overline{\text{MR}}$  to GND to implement a manual reset function; external debounce circuitry is not required. If  $\overline{\text{MR}}$  is driven by long cables or the device is used in a noisy environment, connect a  $0.1\mu\text{F}$  capacitor from  $\overline{\text{MR}}$  to GND to provide additional noise immunity.

### **Watchdog Input**

The MAX6864-MAX6869's watchdog timer circuitry monitors the  $\mu$ P's activity. If the  $\mu$ P does not toggle (low-to-high or high-to-low) the watchdog input (WDI) within the watchdog timeout period ( $t_{WDI}$ ), reset asserts for the reset timeout period ( $t_{RP}$ ). The internal timer is cleared when reset asserts, when manual reset is asserted, or by a rising or falling edge on WDI. The watchdog input detects pulses as short as 150ns. While reset is asserted the watchdog timer does not count. As soon as reset deasserts, the watchdog timer resumes counting (Figure 3).

## Applications Information

### **Selecting the Reset Timeout Period**

The reset timeout period for the MAX6854/MAX6855/MAX6856/MAX6858/MAX6860/MAX6864-MAX6869 is fixed (see Table 4). The MAX6861/MAX6862/MAX6863 feature a reset timeout select input, CT. Connect CT according to Table 1 to select between the available 10ms and 150ms (min) reset timeout periods. The timeout period can be changed while a reset timeout period is in progress, but will not update until the reset timeout period has expired.

**Table 1. MAX6861/MAX6862/MAX6863 Reset Timeout Period Selection**

CT CONNECTION	MIN	TYP	MAX	UNITS
LOW	10	15	25	ms
HIGH	150	225	300	

# Nanopower $\mu$ P Supervisory Circuits with Manual Reset and Watchdog Timer

## Transient Immunity

In addition to issuing a reset to the  $\mu$ P during power-up, power-down, and brownout conditions, the MAX6854/MAX6855/MAX6856/MAX6858/MAX6860–MAX6869 are relatively immune to short-duration supply transients, or glitches. The Maximum  $V_{CC}$  Transient Duration vs. Reset Threshold Overdrive graph in the *Typical Operating Characteristics* shows this relationship.

The area below the curve of the graph is the region in which these devices typically do not generate a reset pulse. This graph was generated using a falling pulse applied to  $V_{CC}$ , starting 100mV above the actual reset threshold,  $V_{TH}$ , and ending below this threshold (reset-threshold overdrive). As the magnitude of the transient increases, the maximum allowable pulse width decreases. Typically, a 100mV  $V_{CC}$  transient duration of 40 $\mu$ s or less does not cause a reset.

## Interfacing to Other Voltages for Logic Compatibility

The open-drain  $\overline{RESET}$  output can be used to interface to a  $\mu$ P with other logic levels. As shown in Figure 4, the open-drain output can be connected to voltages from 0 to 5.5V.

Generally, the pullup resistor connected to  $\overline{RESET}$  connects to the supply voltage that is being monitored at the IC's  $V_{CC}$  input. However, some systems use the

open-drain output to level-shift from the monitored supply to reset circuitry powered by another supply voltage. Keep in mind that as the supervisor's  $V_{CC}$  decreases, so does the IC's ability to sink current at  $\overline{RESET}$ .

## Ensuring a Valid $\overline{RESET}$ Down to $V_{CC} = 0V$ (Push-Pull $\overline{RESET}$ )

When  $V_{CC}$  falls below 1.1V,  $\overline{RESET}$ 's current-sinking capability declines drastically. The high-impedance CMOS logic inputs connected to  $\overline{RESET}$  can drift to undetermined voltages. This presents no problems in most applications, since most  $\mu$ Ps and other circuitry do not operate with  $V_{CC}$  below 1.1V.

In those applications where  $\overline{RESET}$  must be valid down to 0, add a pulldown resistor between  $\overline{RESET}$  and GND for the MAX6854/MAX6858/MAX6861/MAX6864/MAX6867 push-pull outputs. The resistor sinks any stray leakage currents, holding  $\overline{RESET}$  low (Figure 5). Choose a pulldown resistor that accommodates leakages, such that  $\overline{RESET}$  is not significantly loaded and is capable of pulling to GND. The external pulldown cannot be used with the open-drain reset outputs.

## Watchdog Software Considerations

One way to help the watchdog timer monitor software execution more closely is to set and reset the watchdog

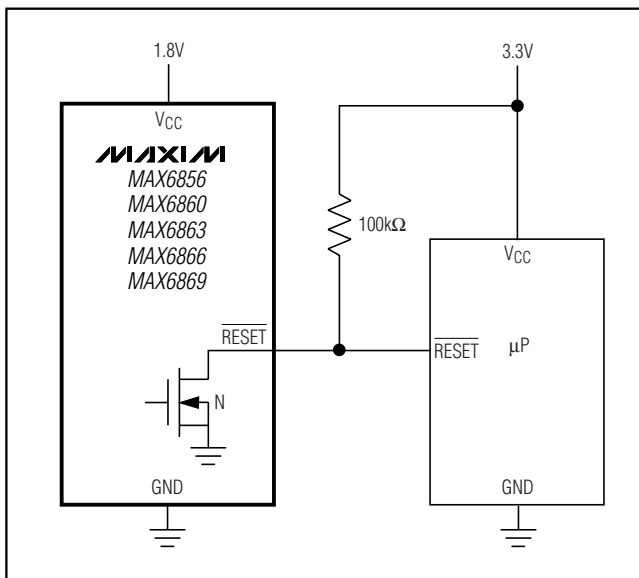

Figure 4. Interfacing with Other Voltage Levels

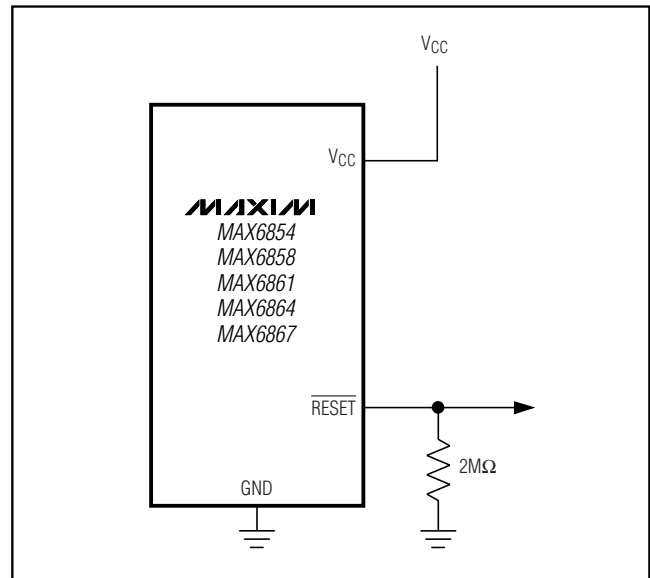

Figure 5. Ensuring  $\overline{RESET}$  Valid to  $V_{CC} = \text{Ground}$

# Nanopower $\mu$ P Supervisory Circuits with Manual Reset and Watchdog Timer

input at different points in the program, rather than pulsing the watchdog input high-low-high or low-high-low. This technique avoids a stuck loop, in which the watchdog timer would continue to be reset inside the loop, keeping the watchdog from timing out.

Figure 6 shows an example of a flow diagram where the I/O driving the watchdog input is set high at the beginning of the program, set low at the beginning of every subroutine or loop, then set high again when the program returns to the beginning. If the program should hang in any subroutine, the problem would quickly be corrected, since the I/O is continually set low and the watchdog timer is allowed to time out, causing a reset or interrupt to be issued.



Figure 6. Watchdog Flow Diagram

Table 2. Threshold Suffix Guide

SUFFIX	V <sub>CC</sub> THRESHOLD FALLING			UNITS
	MIN	TYP	MAX	
46	4.509	4.625	4.741	V
45	4.388	4.500	4.613	
44	4.266	4.375	4.484	
43	4.193	4.300	4.408	
42	4.095	4.200	4.305	
41	3.998	4.100	4.203	
40	3.900	4.000	4.100	
39	3.802	3.900	3.998	
38	3.705	3.800	3.895	
37	3.608	3.700	3.793	
36	3.510	3.600	3.690	
35	3.413	3.500	3.588	
34	3.315	3.400	3.485	
33	3.218	3.300	3.383	
32	3.120	3.200	3.280	
31	2.998	3.075	3.152	
30	2.925	3.000	3.075	
29	2.852	2.925	2.998	
28	2.730	2.800	2.870	
27	2.633	2.700	2.768	
26	2.559	2.625	2.691	
25	2.438	2.500	2.563	
24	2.340	2.400	2.460	
23	2.255	2.313	2.371	
225	2.180	2.235	2.290	
22	2.133	2.188	2.243	
21	2.048	2.100	2.153	
20	1.950	2.000	2.050	
19	1.853	1.900	1.948	
18	1.755	1.800	1.845	
17	1.623	1.665	1.707	
16	1.536	1.575	1.614	

Table 3. Watchdog Timeout

SUFFIX	WATCHDOG TIMEOUT PERIOD			UNITS
	MIN	TYP	MAX	
S	1.5	3.3	7.75	s
L	95	209	487	

MAX6854/MAX6855/MAX6856/MAX6858/MAX6860-MAX6869

# Nanopower $\mu$ P Supervisory Circuits with Manual Reset and Watchdog Timer

Table 4. Reset Timeout Periods

TIMEOUT OPTION	RESET TIMEOUT PERIODS			UNITS
	MIN	TYP	MAX	
D1	10	15	25	ms
D2	40	60	80	
D3	150	225	300	
D4	1200	1800	2400	
D5	300	450	600	
D6	600	900	1200	

Table 5. Standard Versions

PART	TOP MARK
MAX6854UK16D3	AEFS
MAX6854UK23D3	AEFY
MAX6854UK26D3	AEFZ
MAX6854UK29D3	AEGA
MAX6854UK31D3	AEGB
MAX6856UK16D3	AEGR
MAX6856UK23D3	AEGS
MAX6856UK26D3	AEGT
MAX6856UK29D3	AEGU
MAX6856UK31D3	AEGV
MAX6861UK17	AEKO
MAX6861UK225	AEKS
MAX6861UK26	AEKP
MAX6861UK29	AEKQ
MAX6862UK17	AEOS
MAX6862UK225	AEOT
MAX6862UK26	AEOU
MAX6862UK29	AEOV
MAX6863UK17	AEOW
MAX6863UK225	AEOX
MAX6863UK26	AEOY
MAX6863UK29	AEOZ
MAX6864UK16D3S	AEGC
MAX6864UK23D3S	AEGD
MAX6864UK26D3S	AEGE
MAX6864UK29D3S	AEGF
MAX6864UK31D3S	AEGG
MAX6866UK16D3S	AEGW
MAX6866UK23D3S	AEGX
MAX6866UK26D3S	AEGY
MAX6866UK29D3S	AEFT
MAX6866UK31D3S	AEGZ

## Ordering Information (continued)

PART <sup>†</sup>	TEMP RANGE	PIN-PACKAGE
MAX6856UK__D_-T	-40°C to +85°C	5 SOT23-5
MAX6858UK__D_-T	-40°C to +85°C	5 SOT23-5
MAX6860UK__D_-T	-40°C to +85°C	5 SOT23-5
MAX6861UK__-T	-40°C to +85°C	5 SOT23-5
MAX6862UK__-T	-40°C to +85°C	5 SOT23-5
MAX6863UK__-T	-40°C to +85°C	5 SOT23-5
MAX6864UK__D__-T	-40°C to +85°C	5 SOT23-5
MAX6865UK__D__-T	-40°C to +85°C	5 SOT23-5
MAX6866UK__D__-T	-40°C to +85°C	5 SOT23-5
MAX6867UK__D__-T	-40°C to +85°C	5 SOT23-5
MAX6868UK__D__-T	-40°C to +85°C	5 SOT23-5
MAX6869UK__D__-T	-40°C to +85°C	5 SOT23-5

<sup>†</sup> Insert reset threshold suffix (see Table 2, Threshold Suffix Guide) after UK. Insert the number corresponding to the desired reset timeout period (see Table 4, Reset Timeout Period) after D. Insert the letter corresponding to the desired watchdog timeout period (S or L, see Table 3) into the blank following the reset timeout period suffix for the MAX6864–MAX6869.

**Note:** Sample stock is generally held on standard versions only (see Table 5, Standard Versions Table). Standard versions have an order increment of 2500 pieces. Nonstandard versions have an order increment of 10,000 pieces. Contact factory for availability of nonstandard versions.

Devices are available in both leaded and lead-free packaging. Specify lead-free by replacing “-T” with “+T” when ordering.

# Nanopower $\mu$ P Supervisory Circuits with Manual Reset and Watchdog Timer

## Pin Configurations



MAX6854/MAX6855/MAX6856/MAX6858/MAX6860-MAX6869

# Nanopower $\mu$ P Supervisory Circuits with Manual Reset and Watchdog Timer

## Selector Guide

PART	RESET OUTPUT			$\overline{\text{MR}}$	WDI	CT
	PUSH-PULL ACTIVE LOW	PUSH-PULL ACTIVE HIGH	OPEN-DRAIN ACTIVE LOW			
MAX6854	√	—	—	√	—	—
MAX6855	—	√	—	√	—	—
MAX6856	—	—	√	√	—	—
MAX6858	√	—	—	—	—	—
MAX6860	—	—	√	—	—	—
MAX6861	√	—	—	√	—	√
MAX6862	—	√	—	√	—	√
MAX6863	—	—	√	√	—	√
MAX6864	√	—	—	√	√	—
MAX6865	—	√	—	√	√	—
MAX6866	—	—	√	√	√	—
MAX6867	√	—	—	√	√	—
MAX6868	—	√	—	√	√	—
MAX6869	—	—	√	√	√	—

## Chip Information

TRANSISTOR COUNT: 2848

PROCESS: BiCMOS

MAX6854/MAX6855/MAX6856/MAX6858/MAX6860-MAX6869



# Nanopower $\mu$ P Supervisory Circuits with Manual Reset and Watchdog Timer

## Package Information

(The package drawing(s) in this data sheet may not reflect the most current specifications. For the latest package outline information go to [www.maxim-ic.com/packages](http://www.maxim-ic.com/packages).)



SOT-23 5L .EPS

MAX6854/MAX6855/MAX6856/MAX6858/MAX6860-MAX6869

Maxim cannot assume responsibility for use of any circuitry other than circuitry entirely embodied in a Maxim product. No circuit patent licenses are implied. Maxim reserves the right to change the circuitry and specifications without notice at any time.

Maxim Integrated Products, 120 San Gabriel Drive, Sunnyvale, CA 94086 408-737-7600 17

Компания «Океан Электроники» предлагает заключение долгосрочных отношений при поставках импортных электронных компонентов на взаимовыгодных условиях!

Наши преимущества:

- Поставка оригинальных импортных электронных компонентов напрямую с производств Америки, Европы и Азии, а так же с крупнейших складов мира;
- Широкая линейка поставок активных и пассивных импортных электронных компонентов (более 30 млн. наименований);
- Поставка сложных, дефицитных, либо снятых с производства позиций;
- Оперативные сроки поставки под заказ (от 5 рабочих дней);
- Экспресс доставка в любую точку России;
- Помощь Конструкторского Отдела и консультации квалифицированных инженеров;
- Техническая поддержка проекта, помощь в подборе аналогов, поставка прототипов;
- Поставка электронных компонентов под контролем ВП;
- Система менеджмента качества сертифицирована по Международному стандарту ISO 9001;
- При необходимости вся продукция военного и аэрокосмического назначения проходит испытания и сертификацию в лаборатории (по согласованию с заказчиком);
- Поставка специализированных компонентов военного и аэрокосмического уровня качества (Xilinx, Altera, Analog Devices, Intersil, Interpoint, Microsemi, Actel, Aeroflex, Peregrine, VPT, Syfer, Eurofarad, Texas Instruments, MS Kennedy, Miteq, Cobham, E2V, MA-COM, Hittite, Mini-Circuits, General Dynamics и др.);

Компания «Океан Электроники» является официальным дистрибьютором и эксклюзивным представителем в России одного из крупнейших производителей разъемов военного и аэрокосмического назначения «JONHON», а так же официальным дистрибьютором и эксклюзивным представителем в России производителя высокотехнологичных и надежных решений для передачи СВЧ сигналов «FORSTAR».



## JONHON

«JONHON» (основан в 1970 г.)

Разъемы специального, военного и аэрокосмического назначения:

(Применяются в военной, авиационной, аэрокосмической, морской, железнодорожной, горно- и нефтедобывающей отраслях промышленности)

«FORSTAR» (основан в 1998 г.)

ВЧ соединители, коаксиальные кабели, кабельные сборки и микроволновые компоненты:

(Применяются в телекоммуникациях гражданского и специального назначения, в средствах связи, РЛС, а так же военной, авиационной и аэрокосмической отраслях промышленности).



Телефон: 8 (812) 309-75-97 (многоканальный)

Факс: 8 (812) 320-03-32

Электронная почта: [ocean@oceanchips.ru](mailto:ocean@oceanchips.ru)

Web: <http://oceanchips.ru/>

Адрес: 198099, г. Санкт-Петербург, ул. Калинина, д. 2, корп. 4, лит. А