

DWG. NO.

SA94843

RBGT GROUNDING & RBMT MOUNTING TRACKS

THIS DRAWING IS A CONTROLLED DOCUMENT FOR SOURIAU USA, INC. IT IS SUBJECT TO CHANGE WITHOUT NOTIFICATION. CONTACT THE DOCUMENT CONTROL CENTER FOR THE LATEST REVISION.

PRO-E

THE INFORMATION CONTAINED IN THIS DRAWING IS CONFIDENTIAL AND MAY NOT BE DISCLOSED WITHOUT WRITTEN CONSENT FROM SOURIAU USA, INC.

SUPERSEDES: SE94843-5

REV	DESCRIPTION	BY DATE	CHKD DATE
U	REVISED PER ECN 12047	RSK 10-09-13	SDH 10-09-13
T	REVISED PER ECN 11710	RSK 05-02-12	SDH 05-02-12
S	REVISED PER ECN 11271	VKP 11-15-10	SDH 11-15-10
R	REVISED PER ECN 7622	JRD 09-20-02	SDH 09-20-02

DRAWING TITLE

TRACKS, GROUNDING & MOUNTING

LINEAR MEASURE:  INCH [mm]

CAT NO. **RBGT _ & RBMT _ (SEE TABLE, SHT. 2)**

THIRD ANGLE PROJECTION

CAGE NO.: 09922

SIZE: A

APPROVAL

DRAWN:	VKP	11-15-10
CHKD :	SDH	11-15-10
DSGN :	JDA	10-13-92
MFG :	DH	11-15-10
QC :	DK	11-15-10

DRAWING SCALE: 1:1
DRAWING NO. REV

SA94843 U

1 OF 6

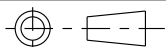

TOLERANCES UNLESS OTHERWISE SPECIFIED

CUSTOMER

SOURIAU

www.souriau.com

INTERPRET THIS DRAWING IN ACCORDANCE WITH ASME Y14.5M - 1994.

No. OF PLACES	INCH [mm]
ONE PLACE	±.1 [±3]
TWO PLACES	±.02 [±0.5]
THREE PLACES	±.010 [±0.25]
ANGLES ±1°	

DWG. NO.
SA94843

NOTES:

- 1. GROUNDING TRACK ACCOMMODATES PIN CONTACTS PER MIL-C-39029/1-101. WITH A WIRE RANGE OF 24-22-20 AWG. USE INSERTION/REMOVAL TOOL PER MIL-I-81969/14C-11.

MATERIAL:

- STRAIN RELIEF GROMMET: SILICONE RUBBER, COLOR RED
- GROMMET BONDING: EPOXY
- GROUNDING MODULE BODY: GLASS FORTIFIED THERMOPLASTIC UL94V-0. COLOR BLUE
- GROUNDING AND MOUNTING TRACKS: 6063-T6 ALUMINUM
- GROUNDING RIVETS: ALUMINUM ALLOY
- GROUNDING SOCKET CONTACTS: BERYLLIUM COPPER
- CONTACT RETENTION CLIPS: BERYLLIUM COPPER
- SOCKET CONTACT SLEEVES: THERMOPLASTIC, LIQUID CRYSTAL POLYMER
- TERMINAL IDENTIFICATION STRIP: THERMOPLASTIC, UL94V-0, COLOR WHITE
- PROTECTIVE COATING: POLYURETHANE, COLOR OPTIONAL

FINISH:

- GROUNDING AND MOUNTING TRACKS: CHROMATE CONVERSION COATING PER MIL-C-81706, CLASS 3, METHOD C, COLOR GOLD. (REF: ALODINE 1200)
- GROUNDING SOCKET CONTACTS: 50 MICROINCHES [1.27 MICRONS] MIN. NICKEL ALL OVER. PIN CONTACT CURRENT BEARING SURFACE OVER-PLATED WITH 50 MICROINCHES [1.27 MICRONS] MIN. HARD GOLD.

DESCRIPTION TABLE		
SOURIAU CATALOG NO.	(O.A LENGTH)	WEIGHT (g)
RBGT2	2.000 [50.80]	17.5
RBGT4	4.000 [101.60]	35.0
RBGT6	6.000 [152.40]	52.5
RBGT8	8.000 [203.20]	70.0
RBGT10	10.000 [254.00]	87.5
RBGT14	14.000 [355.60]	122.5
RBGT16	16.000 [406.40]	140.0
RBGT18	18.000 [457.20]	157.5
RBGT20	20.000 [508]	175.0
RBGT22	22.000 [558.80]	192.5
RBGT26	26.000 [660.40]	227.5
RBGT28	28.000 [711.20]	245.0
RBGT34	34.000 [863.60]	297.5
RBGT38	38.000 [965.20]	332.5
RBMT2	2.000 [50.80]	6.25
RBMT4	4.000 [101.60]	12.5
RBMT6	6.000 [152.40]	18.75
RBMT8	8.000 [203.20]	25.0
RBMT10	10.000 [254.00]	31.25
RBMT14	14.000 [355.60]	43.75
RBMT16	16.000 [406.40]	50.0
RBMT18	18.000 [457.20]	56.25
RBMT20	20.000 [508]	62.5
RBMT22	22.000 [558.80]	68.75
RBMT26	26.000 [660.40]	81.25
RBMT28	28.000 [711.20]	87.5
RBMT34	34.000 [863.60]	106.25
RBMT38	38.000 [965.20]	118.75

---	ALL REV. RECORDED ON SHT. 1	---	---
REV		BY DATE	CHKD DATE

DRAWING TITLE			
TRACKS, GROUNDING & MOUNTING			
RBGT _ & RBMT _ (SEE TABLE, SHT. 2)			
CAT NO.	SIZE: A	DRAWN: VKP 11-15-10	
CAGE NO.: 09922	SOURIAU	CHKD : SDH 11-15-10	
CUSTOMER		DSGN : JDA 10-13-92	
		MFG : DH 11-15-10	
		QC : DK 11-15-10	
		DRAWING SCALE: 1:1	
INTERPRET THIS DRAWING IN ACCORDANCE WITH ASME Y14.5M - 1994.		DRAWING NO. REV	
		SA94843 U	
		2 OF 6	
www.souriau.com			

LINEAR MEASURE:		INCH [mm]
THIRD ANGLE PROJECTION		
TOLERANCES UNLESS OTHERWISE SPECIFIED		
No. OF PLACES	INCH [mm]	
ONE PLACE	±.1 [±3]	
TWO PLACES	±.02 [±0.5]	
THREE PLACES	±.010 [±0.25]	
ANGLES ±1°		

THIS DRAWING IS A CONTROLLED DOCUMENT FOR SOURIAU USA, INC. IT IS SUBJECT TO CHANGE WITHOUT NOTIFICATION. CONTACT THE DOCUMENT CONTROL CENTER FOR THE LATEST REVISION.

PRO-E

THE INFORMATION CONTAINED IN THIS DRAWING IS CONFIDENTIAL AND MAY NOT BE DISCLOSED WITHOUT WRITTEN CONSENT FROM SOURIAU USA, INC.

DWG. NO.

SA94843

PERFORMANCE CHARACTERISTICS

ELECTRICAL:

CONTACT RESISTANCE: IN ACCORDANCE WITH MIL-T-81714, PARA. 4.6.16.
 REF: MIL-STD-1344, METHOD 3004.
 SIZE 16-20: 45 MILLIVOLTS MAX. AT 7.5A WITH
 20 AWG SILVER PLATED WIRE.

LOW LEVEL CONTACT RESISTANCE: IN ACCORDANCE WITH MIL-T-81714, PARA. 4.6.17.
 REF: MIL-STD-1344, METHOD 3002.
 SIZE 16-20: .009 OHMS MAX. WITH
 20 AWG SILVER PLATED WIRE.

VOLTAGE STABILITY: 4 MILLIVOLT MAX. DIFFERENCE BETWEEN RECORDED HIGHEST
 AND LOWEST POTENTIAL DROP VALUES IN ACCORDANCE WITH
 MIL-T-81714, PARA. 4.6.18.

ENVIRONMENTAL:

FLUID IMMERSION: ALL MATERIALS ARE RESISTANT TO BMS3-11 (SKYDROL LD-4) AND
 MIL-H-5606 HYDRAULIC FLUIDS, AND MIL-L-7808 AND
 MIL-L-23699 LUBRICATING OILS.

HUMIDITY: IN ACCORDANCE WITH MIL-T-81714, PARA. 4.6.10.
 REF: MIL-STD-1344, METHOD 1002, TYPE II, (EXCEPT WITHOUT
 STEP 7b)

SALT SPRAY: 500 HOURS IN ACCORDANCE WITH MIL-T-81714, PARA. 4.6.12.
 REF: MIL-STD-1344, METHOD 1001, TEST CONDITION C.

VIBRATION (SINUSOIDAL): IN ACCORDANCE WITH MIL-T-81714, PARA. 4.6.8.1.
 REF: MIL-STD-202, METHOD 204, TEST CONDITION G.

VIBRATION (RANDOM): IN ACCORDANCE WITH MIL-T-81714, PARA. 4.6.8.2.
 REF: MIL-STD-1344, METHOD 2005, TEST CONDITION VI. LETTER J.

MECHANICAL (IMPACT) SHOCK: IN ACCORDANCE WITH MIL-T-81714, PARA. 4.6.9.
 REF: MIL-STD-1344, METHOD 2004, TEST CONDITION D.

THERMAL SHOCK: IN ACCORDANCE WITH MIL-T-81714, PARA. 4.6.5.
 REF: MIL-STD-1344, METHOD 1003, TEST CONDITION A,
 (EXCEPT TEMPERATURE EXTREMES ARE -65°C TO +150°C
 [-85°F TO +302°F]).

TEMPERATURE LIFE: 150°C [302°F] FOR 1000 HOURS IN ACCORDANCE WITH
 MIL-T-81714, PARA. 4.6.13.

OZONE: IN ACCORDANCE WITH MIL-T-81714, PARA. 4.6.14.
 REF: MIL-STD-1344, METHOD 1007.

---	ALL REV. RECORDED ON SHT. 1	---	---
REV	DESCRIPTION	BY DATE	CHKD DATE

DRAWING TITLE

TRACKS, GROUNDING & MOUNTING

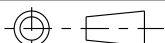
LINEAR MEASURE:  INCH [mm]		CAT NO. RBGT & RBMT (SEE TABLE, SHT. 2)	
THIRD ANGLE PROJECTION 		CAGE NO.: 09922	
TOLERANCES UNLESS OTHERWISE SPECIFIED		SIZE: A	
No. OF PLACES INCH [mm]		DRAWN: VKP 11-15-10	
ONE PLACE ±.1 [±3]		CHKD : SDH 11-15-10	
TWO PLACES ±.02 [±0.5]		DSGN : JDA 10-13-92	
THREE PLACES ±.010 [±0.25]		MFG : DH 11-15-10	
ANGLES ±1°		QC : DK 11-15-10	
INTERPRET THIS DRAWING IN ACCORDANCE WITH ASME Y14.5M - 1994.		DRAWING SCALE: 1:1	
		DRAWING NO. REV	
		SA94843 U	
		3 OF 6	

CUSTOMER

SOURIAU

www.souriau.com

THIS DRAWING IS A CONTROLLED DOCUMENT FOR SOURIAU USA, INC. IT IS SUBJECT TO CHANGE WITHOUT NOTIFICATION. CONTACT THE DOCUMENT CONTROL CENTER FOR THE LATEST REVISION.

PRO-E

THE INFORMATION CONTAINED IN THIS DRAWING IS CONFIDENTIAL AND MAY NOT BE DISCLOSED WITHOUT WRITTEN CONSENT FROM SOURIAU USA, INC.

DWG. NO.

SA94843

PERFORMANCE CHARACTERISTICS

MECHANICAL:

- MAGNETIC PERMEABILITY:** ALL MATERIALS DO NOT EXHIBIT A RELATIVE MAGNETIC PERMEABILITY OF GREATER THAN 2 IN ACCORDANCE WITH MIL-T-81714, PARA. 4.6.15. REF: MIL-STD-1344, METHOD 3006.
- MAINTENANCE AGING:** IN ACCORDANCE WITH MIL-T-81714, PARA. 4.6.3.
- CONTACT INSERTION/REMOVAL FORCE:** 10 LBS [44,4N] MAX. IN ACCORDANCE WITH MIL-T-81714, PARA.4.6.3
- CONTACT RETENTION:** 20 LBS [88,9N] MIN. IN ACCORDANCE WITH MIL-T-81714, PARA. 4.6.4. AXIAL DISPLACEMENT DOES NOT EXCEED .012 [0,30]. REF: MIL-STD-1344, METHOD 2007.
- PROBE DAMAGE:** IN ACCORDANCE WITH MIL-T-81714, PARA. 4.6.2.
- RETENTION SYSTEM FLUID IMMERSION:** IN ACCORDANCE WITH MIL-T-81714, PARA. 4.6.23.
- INTERNAL CONTACT DURABILITY:** 100 CYCLES OF MATING AND UNMATING TO DEPTH OF MECHANICAL AND ELECTRICAL ENGAGEMENT IN ACCORDANCE WITH MIL-T-81714, PARA. 4.6.19.
- OVERSIZE PIN CONTACT PROTECTION:** GROUNDING MODULE DESIGNED TO PREVENT ENTRANCE OF AN OVERSIZE TEST PIN OF Ø.070 [1,78] IN ACCORDANCE WITH MIL-T-81714, PARA. 4.6.20.
- CONTACT WALKOUT:** IN ACCORDANCE WITH MIL-T-81714, PARA. 4.6.22. REF: MIL-STD-1549.

SEE DRAWING SE94834 FOR
FEEDBACK MODULE

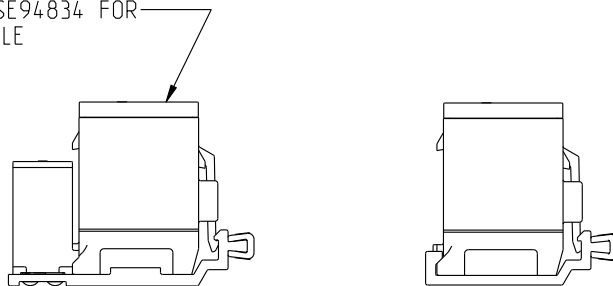

FEEDBACK MODULE INSTALLED IN
GROUNDING AND MOUNTING TRACKS
SCALE 1:1

---	ALL REV. RECORDED ON SHT. 1	---	---
REV	DESCRIPTION	BY DATE	CHKD DATE

DRAWING TITLE			
TRACKS, GROUNDING & MOUNTING			
CAT NO. RBGT _ & RBMT _ (SEE TABLE, SHT. 2)			
CAGE NO.: 09922		SIZE: A	
CUSTOMER		SOURIAU	
INTERPRET THIS DRAWING IN ACCORDANCE WITH ASME Y14.5M - 1994.		APPROVAL	
		DRAWN: VKP	11-15-10
		CHKD : SDH	11-15-10
		DSGN : JDA	10-13-92
		MFG : DH	11-15-10
		QC : DK	11-15-10
		DRAWING SCALE: 1:1	
		DRAWING NO.	REV
		SA94843	U
		4 OF 6	

LINEAR MEASURE:		INCH [mm]
THIRD ANGLE PROJECTION		
TOLERANCES UNLESS OTHERWISE SPECIFIED		
No. OF PLACES	INCH [mm]	
ONE PLACE	±.1 [±3]	
TWO PLACES	±.02 [±0.5]	
THREE PLACES	±.010 [±0.25]	
ANGLES ±1°		

THIS DRAWING IS A CONTROLLED DOCUMENT FOR SOURIAU USA, INC. IT IS SUBJECT TO CHANGE WITHOUT NOTIFICATION. CONTACT THE DOCUMENT CONTROL CENTER FOR THE LATEST REVISION.

PRO-E

THE INFORMATION CONTAINED IN THIS DRAWING IS CONFIDENTIAL AND MAY NOT BE DISCLOSED WITHOUT WRITTEN CONSENT FROM SOURIAU USA, INC.

DWG. NO.

SA94843

THIS DRAWING IS A CONTROLLED DOCUMENT FOR SOURIAU USA, INC. IT IS SUBJECT TO CHANGE WITHOUT NOTIFICATION. CONTACT THE DOCUMENT CONTROL CENTER FOR THE LATEST REVISION.

PRO-E

THE INFORMATION CONTAINED IN THIS DRAWING IS CONFIDENTIAL AND MAY NOT BE DISCLOSED WITHOUT WRITTEN CONSENT FROM SOURIAU USA, INC.

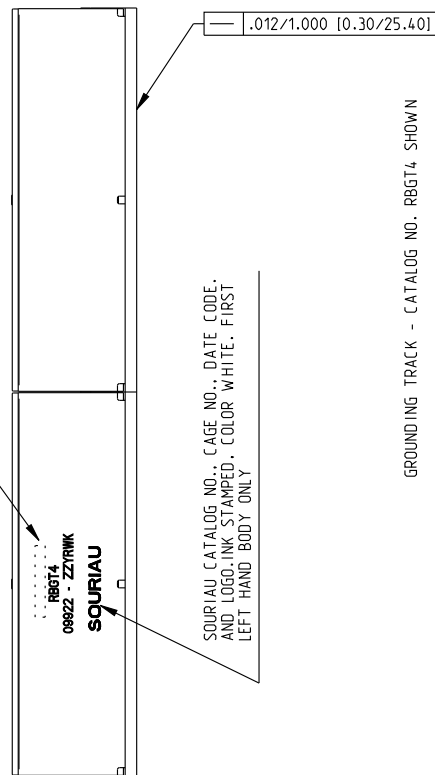
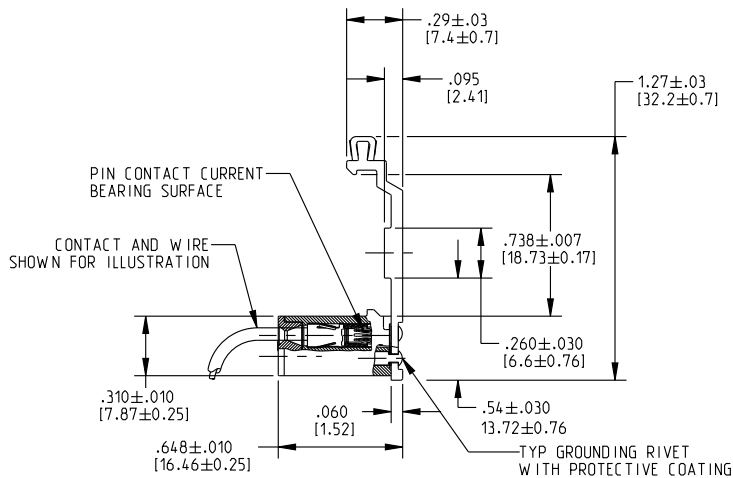

GROUNDING TRACK - CATALOG NO. RBGT4 SHOWN

---	ALL REV. RECORDED ON SHT. 1	---	---
REV	DESCRIPTION	BY DATE	CHKD DATE

DRAWING TITLE
TRACKS, GROUNDING & MOUNTING

CAT NO. **RBGT & RBMT (SEE TABLE, SHT. 2)**

CAGE NO.: 09922 SIZE: A

<p>LINEAR MEASURE: INCH [mm] INCH [mm]</p> <p>THIRD ANGLE PROJECTION</p> <p>TOLERANCES UNLESS OTHERWISE SPECIFIED</p> <table border="1"> <tr> <th>No. OF PLACES</th> <th>INCH [mm]</th> </tr> <tr> <td>ONE PLACE</td> <td>±.1 [±3]</td> </tr> <tr> <td>TWO PLACES</td> <td>±.02 [±0.5]</td> </tr> <tr> <td>THREE PLACES</td> <td>±.010 [±0.25]</td> </tr> <tr> <td colspan="2">ANGLES ±1°</td> </tr> </table>	No. OF PLACES	INCH [mm]	ONE PLACE	±.1 [±3]	TWO PLACES	±.02 [±0.5]	THREE PLACES	±.010 [±0.25]	ANGLES ±1°		<p>CUSTOMER</p> <p>INTERPRET THIS DRAWING IN ACCORDANCE WITH ASME Y14.5M - 1994.</p>	<p>SOURIAU</p> <p>www.souriau.com</p>	<p>APPROVAL</p> <table border="1"> <tr> <td>DRAWN:</td> <td>VKP</td> <td>11-15-10</td> </tr> <tr> <td>CHKD :</td> <td>SDH</td> <td>11-15-10</td> </tr> <tr> <td>DSGN :</td> <td>JDA</td> <td>10-13-92</td> </tr> <tr> <td>MFG :</td> <td>DH</td> <td>11-15-10</td> </tr> <tr> <td>QC :</td> <td>DK</td> <td>11-15-10</td> </tr> </table>	DRAWN:	VKP	11-15-10	CHKD :	SDH	11-15-10	DSGN :	JDA	10-13-92	MFG :	DH	11-15-10	QC :	DK	11-15-10
	No. OF PLACES	INCH [mm]																										
ONE PLACE	±.1 [±3]																											
TWO PLACES	±.02 [±0.5]																											
THREE PLACES	±.010 [±0.25]																											
ANGLES ±1°																												
DRAWN:	VKP	11-15-10																										
CHKD :	SDH	11-15-10																										
DSGN :	JDA	10-13-92																										
MFG :	DH	11-15-10																										
QC :	DK	11-15-10																										
<p>DRAWING SCALE: 1:1</p> <p>DRAWING NO. SA94843</p>		<p>REV U</p> <p>5 OF 6</p>																										

THIS DRAWING IS A CONTROLLED DOCUMENT FOR SOURIAU USA, INC. IT IS SUBJECT TO CHANGE WITHOUT NOTIFICATION. CONTACT THE DOCUMENT CONTROL CENTER FOR THE LATEST REVISION.

PRO-E

THIS DRAWING IS CONFIDENTIAL AND MAY NOT BE DISCLOSED WITHOUT WRITTEN CONSENT FROM SOURIAU USA, INC.

DWG. NO.

SA94843

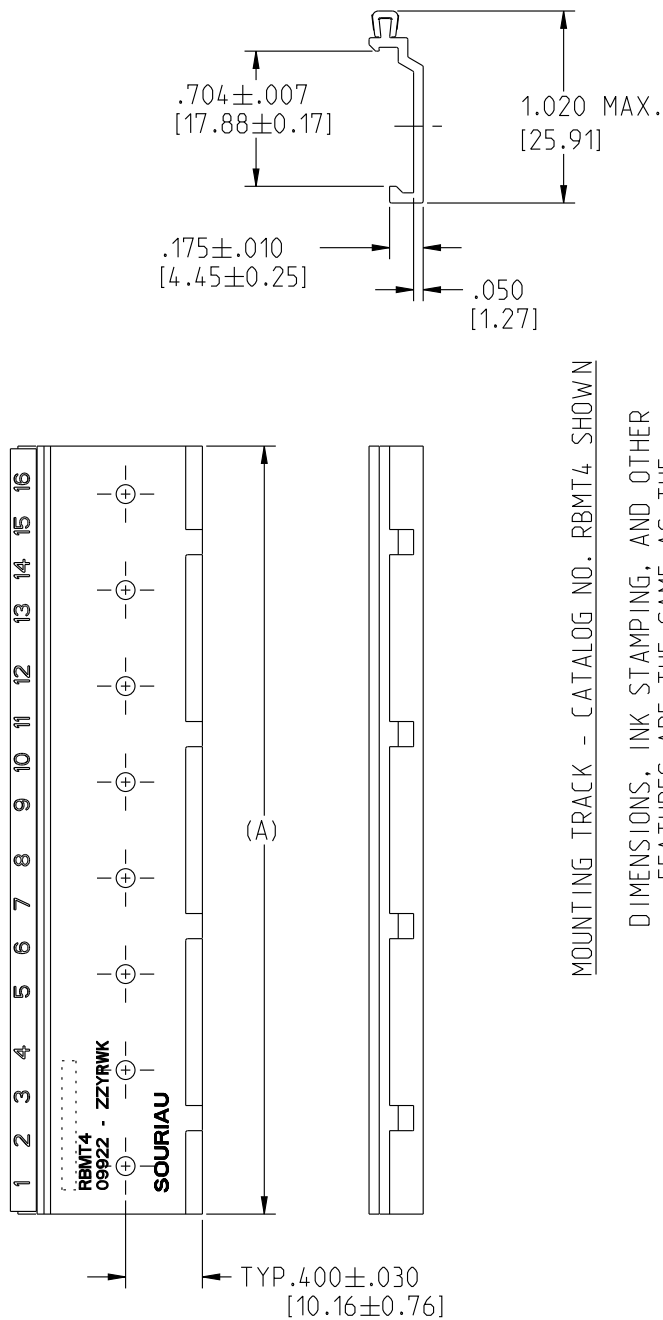

MOUNTING TRACK - CATALOG NO. RBMT4 SHOWN

DIMENSIONS, INK STAMPING, AND OTHER FEATURES ARE THE SAME AS THE GROUNDING TRACK EXCEPT AS SHOWN.

SOURIAU CATALOG NO.	BOEING PART NO.	MOUNTING TRACK		FEEDBACK MODULES ACCOMMODATED SEE DWG. SE94834
		SOURIAU CATALOG NO.	BOEING PART NO.	
RBGT2	S280W 555-502	RBMT2	S280W 555-602	2
RBGT4	S280W 555-504	RBMT4	S280W 555-604	4
RBGT6	S280W 555-506	RBMT6	S280W 555-606	6
RBGT8	S280W 555-508	RBMT8	S280W 555-608	8
RBGT10	S280W 555-510	RBMT10	S280W 555-610	10
RBGT14	S280W 555-514	RBMT14	S280W 555-614	14
RBGT16	S280W 555-516	RBMT16	S280W 555-616	16
RBGT18	S280W 555-518	RBMT18	S280W 555-618	18
RBGT20	S280W 555-520	RBMT20	S280W 555-620	20
RBGT22	S280W 555-522	RBMT22	S280W 555-622	22
RBGT26	S280W 555-526	RBMT26	S280W 555-626	26
RBGT28	S280W 555-528	RBMT28	S280W 555-628	28
RBGT34	S280W 555-534	RBMT34	S280W 555-634	34
RBGT38	S280W 555-538	RBMT38	S280W 555-638	38

---	ALL REV. RECORDED ON SHT. 1	---	---
REV	ECN NUMBER	BY DATE	CHKD DATE

DRAWING TITLE
TRACKS, GROUNDING & MOUNTING

CAT NO. **RBGT _ & RBMT _ (SEE TABLE, SHT. 2)**

CAGE NO.: 09922 SIZE: A

<p>CUSTOMER</p> <p>INTERPRET THIS DRAWING IN ACCORDANCE WITH ASME Y14.5M - 1994.</p>	<p>APPROVAL</p> <p>DRAWN: VKP 11-15-10</p> <p>CHKD : SDH 11-15-10</p> <p>DSGN : JDA 10-13-92</p> <p>MFG : DH 11-15-10</p> <p>QC : DK 11-15-10</p>
	<p>DRAWING SCALE: 1:1</p>
	<p>DRAWING NO. REV</p> <p>SA94843 U</p>
	<p>6 OF 6</p>
	<p>www.souriau.com</p>

LINEAR MEASURE:	INCH [mm]
THIRD ANGLE PROJECTION	
TOLERANCES UNLESS OTHERWISE SPECIFIED	
No. OF PLACES	INCH [mm]
ONE PLACE	±.1 [±3]
TWO PLACES	±.02 [±0.5]
THREE PLACES	±.010 [±0.25]
ANGLES ±1°	

Компания «Океан Электроники» предлагает заключение долгосрочных отношений при поставках импортных электронных компонентов на взаимовыгодных условиях!

Наши преимущества:

- Поставка оригинальных импортных электронных компонентов напрямую с производств Америки, Европы и Азии, а так же с крупнейших складов мира;
- Широкая линейка поставок активных и пассивных импортных электронных компонентов (более 30 млн. наименований);
- Поставка сложных, дефицитных, либо снятых с производства позиций;
- Оперативные сроки поставки под заказ (от 5 рабочих дней);
- Экспресс доставка в любую точку России;
- Помощь Конструкторского Отдела и консультации квалифицированных инженеров;
- Техническая поддержка проекта, помощь в подборе аналогов, поставка прототипов;
- Поставка электронных компонентов под контролем ВП;
- Система менеджмента качества сертифицирована по Международному стандарту ISO 9001;
- При необходимости вся продукция военного и аэрокосмического назначения проходит испытания и сертификацию в лаборатории (по согласованию с заказчиком);
- Поставка специализированных компонентов военного и аэрокосмического уровня качества (Xilinx, Altera, Analog Devices, Intersil, Interpoint, Microsemi, Actel, Aeroflex, Peregrine, VPT, Syfer, Eurofarad, Texas Instruments, MS Kennedy, Miteq, Cobham, E2V, MA-COM, Hittite, Mini-Circuits, General Dynamics и др.);

Компания «Океан Электроники» является официальным дистрибьютором и эксклюзивным представителем в России одного из крупнейших производителей разъемов военного и аэрокосмического назначения «JONHON», а так же официальным дистрибьютором и эксклюзивным представителем в России производителя высокотехнологичных и надежных решений для передачи СВЧ сигналов «FORSTAR».



JONHON

«JONHON» (основан в 1970 г.)

Разъемы специального, военного и аэрокосмического назначения:

(Применяются в военной, авиационной, аэрокосмической, морской, железнодорожной, горно- и нефтедобывающей отраслях промышленности)

«FORSTAR» (основан в 1998 г.)

ВЧ соединители, коаксиальные кабели, кабельные сборки и микроволновые компоненты:

(Применяются в телекоммуникациях гражданского и специального назначения, в средствах связи, РЛС, а так же военной, авиационной и аэрокосмической отраслях промышленности).



Телефон: 8 (812) 309-75-97 (многоканальный)

Факс: 8 (812) 320-03-32

Электронная почта: ocean@oceanchips.ru

Web: <http://oceanchips.ru/>

Адрес: 198099, г. Санкт-Петербург, ул. Калинина, д. 2, корп. 4, лит. А