

FEATURES

- Large (0.56"/14.2mm) LED display
- 8 LED colors
- Low-power LED's optional
- Epoxy-encapsulated, 12-pin DIP with built-in color filter and bezel
- Miniature size:
2.17" x 0.92" x 0.56"(55mm x 23mm x 14mm)
- Panel or pc-board mountable
- 4 differential input voltage ranges
- Auto-calibration, ± 1 count accuracy
- User-selectable decimal point placement
- Single +5V supply (60mW for low-power models)
- 0 to +60°C temperature range
- Numerous "plug-on" application boards
- Low cost

The DMS-30PC Series is a broad line of self-contained, fully operational, 3½ digit voltmeters with large, easy-to-read LED displays. The 0.56" (14.2mm) high LED's are available in a wide variety of colors including red, orange, amber, yellow, green, aqua, blue-green, and super-blue. A high-intensity version of the red display is optional, as are low-power versions of the red, orange, and green displays.

The small size (2.17" x 0.92" x 0.56") of DMS-30PC meters is achieved by integrating their display, display drivers, reference circuit, and A/D converter into in a single, epoxy-encapsulated assembly. The device's 12-pin, component-like, DIP package is both vibration and moisture proof. Each package incorporates a built-in color filter and bezel and is easily mounted in either panels or pc cards.

These meters are available in four differential input voltage ranges ($\pm 200\text{mV}$, $\pm 2\text{V}$, $\pm 20\text{V}$ and $\pm 200\text{V}$). Input impedance is 1,000 megohms for the $\pm 200\text{mV}$ and $\pm 2\text{V}$ inputs and 1 megohm for the $\pm 20\text{V}$ and $\pm 200\text{V}$ inputs. CMRR for all devices is 86dB, and inputs are overvoltage protected to $\pm 25\text{V}$.

Each meter incorporates an extremely stable, double-regulated reference and is fully calibrated prior to potting. We guarantee outstanding initial accuracy (± 1 count) and excellent stability (± 0.15 counts/ $^{\circ}\text{C}$). All models operate from a single +5V supply, and the low-power models draw as little as 10mA (50mW total power). A DISPLAY TEST function is standard on each device.

For popular applications (4-to-20mA, rms-to-dc conversion, ac line power, J and K thermocouples, etc.), the DMS-30PC Series includes a complete line of optional "plug-on" application boards that conveniently convert your meter into an application-specific instrument.

SIMPLIFIED SCHEMATIC DIAGRAM

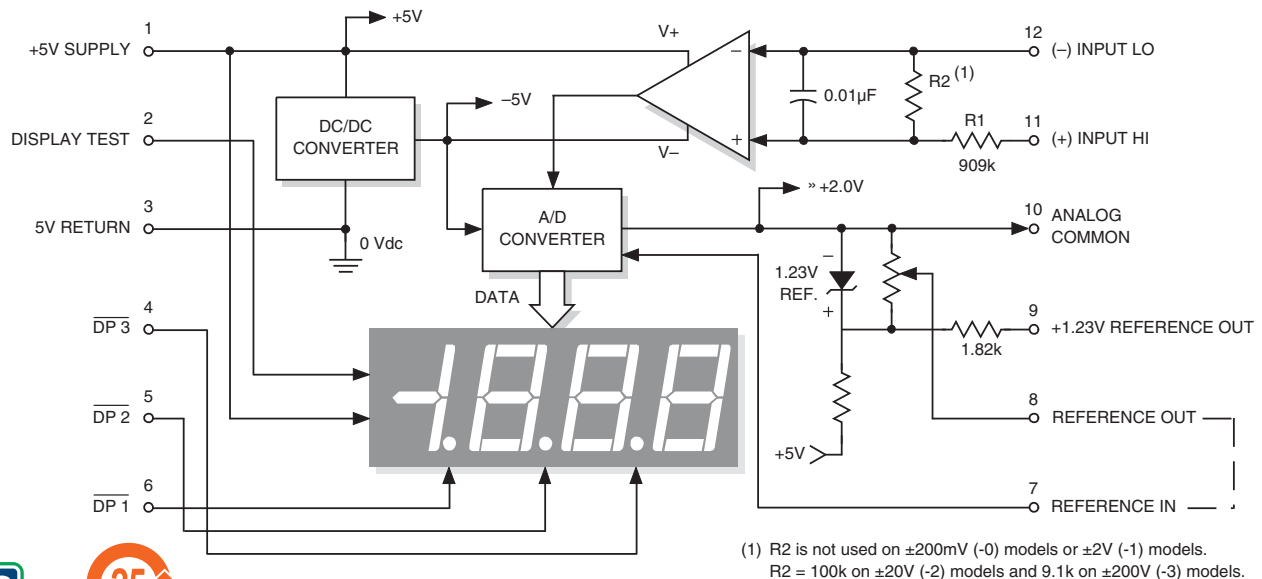

Figure 1. DMS-30PC Series simplified schematic



Performance/Functional Specifications

Typical at T_a = +25°C and supply voltage = +5V using the single-ended input circuit, unless otherwise noted.

Analog Inputs	Min.	Typ.	Max.	Units
Full Scale Input Range:				
DMS-30PC-0	–	±200	–	mV
DMS-30PC-1	–	±2	–	Volts
DMS-30PC-2	–	±20	–	Volts
DMS-30PC-3	–	±200	–	Volts
Input Impedance:				
DMS-30PC-0, -1	100	1000	–	MΩ
DMS-30PC-2, -3	0.8	1	–	MΩ
Overvoltage Protection ①	–	–	±250	Volts
Common Mode Voltage Range	–	–	±2	Volts
CMRR (dc to 60Hz)	–	86	–	dB
Control Inputs ②				
Decimal Point Placement (Pins 4-6)	Tie to pin 3 to activate			
Display Test (Pin 2)	Tie to +5V to activate all segments			
Performance				
Sampling Rate	2.5 reading per second			
Accuracy (3 minute warm-up):				
DMS-30PC-0 (Vin = +0.19V)	–	±1	±3	Counts
DMS-30PC-1 (Vin = +1.9V)	–	±1	±3	Counts
DMS-30PC-2 (Vin = +19V)	–	±2	±3	Counts
DMS-30PC-3 (Vin = +190V)	–	±2	±3	Counts
Zero Reading (Vin = 0 Volts)	“–001”	“000”	“001”	
Temperature Drift (0 = +60°C)	–	±0.2	±0.4	Cnts/°C
+1.23V Reference Output (Pin 9) ②	+1.20	+1.23	+1.25	Volts
Power Supply Requirements				
Supply Voltage	+4.75	+5.00	+5.25	Volts
Supply Current:				
Standard Models	–	+150	+225	mA
Low-Power Models				
Red Display	–	+12	+17	mA
Green or Orange Display	–	+60	+100	mA
Display				
Display Type and Size	3½ digit, 0.56"/14.2mm high LED			
Polarity Indication	Autopolarity (“–” for negative Vin)			
Overrange Indication	“–1___” for negative inputs “1___” for positive inputs			
Physical/Environmental				
Operating Temperature	0	–	+60	°C
Storage Temperature	–40	–	+75	°C
Humidity (non-condensing)	0	–	95	%
Case Material	Polycarbonate			
Weight	0.75 ounces (21 grams)			

① Applies for transient or continuous overvoltages applied to (+) INPUT HI (pin 11) with (–) INPUT LO (pin 12) properly connected. Pin 12 is not overvoltage protected (see Figure 1). Voltages applied to pin 12 should not exceed the supply voltage.

② See Technical Notes.

Ordering Information

DMS-30PC - 1 - RS - C

Add -C for RoHS

Input Range:

- 0 = ±200mV
- 1 = ±2V
- 2 = ±20V
- 3 = ±200V

±200V available on the following models only:
-BS (Super Blue)
-GS (Standard Green)
-RS (Standard Red)
-RL (Low-Power Red)
-VFS (Blue-Green)

LED Color:

- AS = Standard Amber
- BS = Super Blue
- GS = Standard Green
- OS = Standard Orange
- QS = Standard Aqua
- RS = Standard Red
- YS = Standard Yellow
- RH = High-Intensity Red
- GL = Low-Power Green
- OL = Low-Power Orange
- RL = Low-Power Red
- VFS = Blue-Green



Accessories:

- DMS-30-CP Panel cutout punch
- DMS-BZL1-C DMS-30 bezel assembly
- DMS-BZL2-C DMS-30 bezel assembly with sealing gasket

Add-On Application Boards:

- DMS-EB-C Multi-purpose (gain/offset, 4-20mA, etc.)
- DMS-EB-HTB High-accuracy temperature probe sensing for ±200mV models
- DMS-EB-DC/DC Provides isolated +5V power
- DMS-EB-RMS-C For true rms measurements of ac voltages
- DMS-EB-AC/DC-C For ac line-powered applications

A panel-mount retaining clip is supplied with each model.

TECHNICAL NOTES

- +1.23V REFERENCE OUTPUT (Pin 9):** This pin is the output of the meter's precision +1.23V internal reference, and it is referenced to ANALOG COMMON (pin 10) which sits at a potential of approximately +2V. This output should be buffered if used to drive external loads since sourcing more than 15µA from pin 9 can affect both the initial accuracy and temperature drift of the meter.
- ANALOG COMMON (Pin 10):** This pin is connected to an internal, low-noise, "relative" ground. It is used in certain differential and "floating" measurements as described in the Applications section of this data sheet and Ap Note 3 of the DATEL Panel Meter Catalog. Pin 10 should not be connected to pin 3 (5V RETURN) or to your system's analog ground.
- REFERENCE OUTPUT (Pin 8) and INPUT (Pin 7):** Pin 8 is a precision reference actively trimmed at the factory. In normal operation, pin 8 must be tied to pin 7 to achieve all listed accuracy and drift specifications.

APPLICATIONS

4. DISPLAY TEST (Pin 2): Connecting pin 2 to +5V SUPPLY (pin 1) will activate all LED segments, except the decimal points, and the display will read "1888" regardless of the actual applied input. If a negative input is applied, DISPLAY TEST will also activate the minus sign. To protect the LED's, the display should not be left in the "test" mode for more than 10 seconds.

5. Decimal Point Placement: The location of the decimal point is user-selectable, and the decimal point control pins (DP1-DP3) are active low functions. Select the desired decimal point by tying the appropriate pin (pin 4, 5 or 6) to pin 3 (5V RETURN). Unused decimal point location pins should be left open.

Hard wiring is preferable, however, you can use logic gates to exercise dynamic control over the location of the decimal point if the following drive conditions are met:

Model	Applied "0" Voltage	Load Current*
DMS-30PC-X-RL	+0.05V max.	0.7mA max.
All Others	+0.4V max.	6mA max.

* The driving gates must be able to sink this much current (I_{OL}) with a logic "0" output.

6. Gain Adjust: There is a gain-adjust potentiometer on the back of each meter. It has approximately ±50 counts (±2.5%) of adjustment range. Since these devices essentially have no zero/offset errors, a gain adjustment is effectively an overall accuracy adjustment. Though they may be performed at any point (except zero), accuracy adjustments are most effective when performed with higher level input signals. The circuit shown in Figure 10 provides ±10% range of adjustment.

7. Soldering Methods: All models in the DMS-30PC Series easily withstand most common wave soldering operations. We recommend, however, that you evaluate the effects your particular soldering techniques may have on the meter's plastic case and high-precision electrical performance. We recommend the use of no-clean solders.

8. Suggested Mating Connectors:

Panel mounted:

Connector housing	DATEL P/N 4320-01069-0
Terminal type	DATEL P/N 4400-01032-0
Crimping tool	DATEL P/N 39-2099000
Wire size	22 to 26 AWG
Insulation diameter	0.062" (1.57mm) maximum
Stripping length	0.100 to 0.125" (2.54 to 3.17mm)

Board mounted:

Socket	DATEL P/N 4320-01074-0
--------	------------------------

DMS-30PC meters are highly versatile devices that can be used in hundreds of applications. The application circuits chosen for this section have historically received many inquiries. Every attempt has been made to ensure technical accuracy, and all of the following circuits have been prototyped and tested to ensure functionality. Please keep in mind, however, that real-world applications are seldom as straightforward as the approaches presented here. Most applications have many more components — and many more connections — than the illustrations show.

The simplified schematic shown in Figure 1 can be very useful when debugging a malfunctioning panel meter circuit, particularly if the user has some knowledge of operational amplifiers (op amps). The meter's high-impedance input consists of an op amp powered from a ±5Vdc power supply (the -5V is internally generated). Knowing this, one can easily see why input signals applied to (-) INPUT LO and (+) INPUT HI have to be kept within the power supply rails of ±5V. Also note that only pin 11 has a current-limiting 909kΩ series resistor. High input voltages that have a common ground with pin 3 (5V RETURN) should only be applied to pin 11 ((+) INPUT HI) and never to pin 12. In these high-voltage cases, pin 12 should always be tied to pin 3 (5V RETURN).

One of the simplified schematic's noteworthy features is that it shows internal voltage values. It also shows that pin 3 is the meter's zero-volt reference point — regardless of the type of power or signal source used. This is an important point to keep in mind when a digital or analog multimeter is used to make system measurements. The multimeter's negative lead (usually the black one) must be connected to pin 3 (5V RETURN).

1. Single-Ended Input Configurations: True single-ended measurements can be made with any DMS-30PC meter. The circuit of Figure 2 avoids problems normally associated with ground-loop currents. Separate ground runs should be used for 5V RETURN (pin 3) and (-) INPUT LO (pin 12). This will ensure that large LED currents will not flow in the wiring that connects V_{IN} to (-) INPUT LO (pin 12). Ground-loop currents can cause unstable readings.

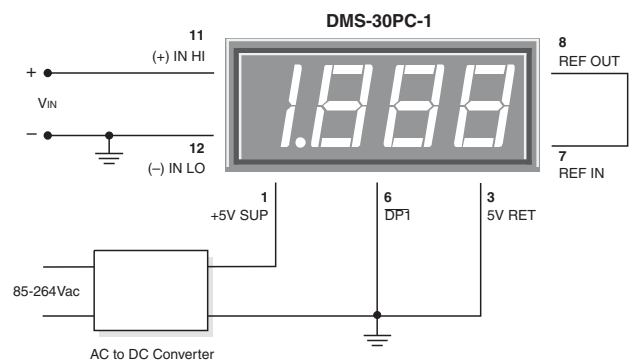

Figure 2. Single-Ended Input Configuration

APPLICATIONS

2. Differential Input Configurations: Differential measurements can be made with all DMS-30PC meters. Figure 3, though not a practical real-world application, uses a voltage divider to demonstrate the concept of a differential input signal. Be careful not to exceed the $\pm 2V$ common mode voltage limitation for 5V-powered meters.

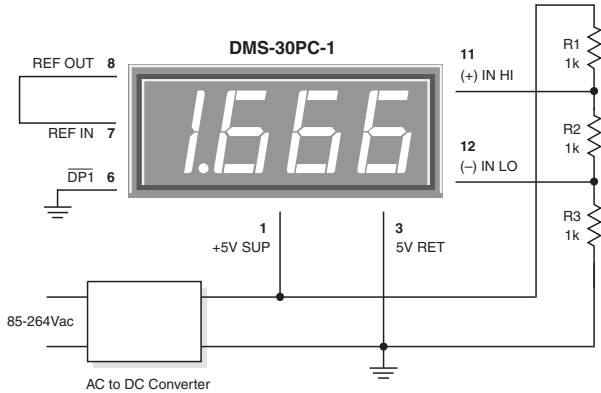

Figure 3. Differential Input Configuration

3. Engineering Scaling: For measuring voltages greater than the full scale input range of a given meter, the input signal must be attenuated. A simple voltage divider (similar to that shown in Figure 4) will scale the input to within the range of the selected meter. R1 and R2 should be precision, $\pm 1\%$, metal-film resistors with absolute TCR's less than 50ppm/°C. See Ap Note 4 for more information on engineering scaling.

$$50k\Omega < R1 + R2 < 10M\Omega$$

$$\frac{R2}{R1 + R2} \times V_{IN} = \text{Reading}$$

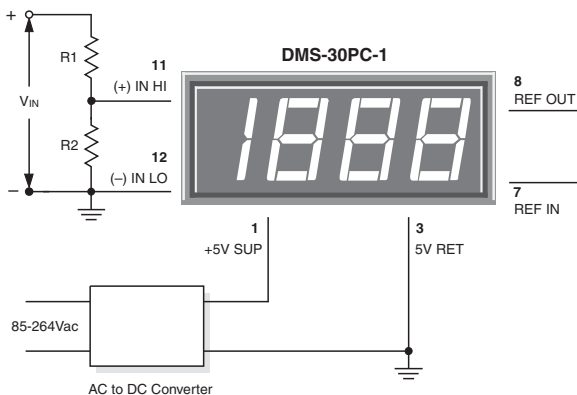

Figure 4. Input Attenuation Circuit

4. Floating Signal Source Measurements: Floating signals can be measured using the circuits shown in Figures 5 and 6. Connecting

pin 10 (ANALOG COMMON) or pin 3 (5V RETURN) to (-) INPUT LO (pin 12) provides the reference point for the meter's input.

A "floating" input is a signal that has no galvanic connection to the meter's power supply. In the figures below, the 1.5V battery illustrates a true floating input.

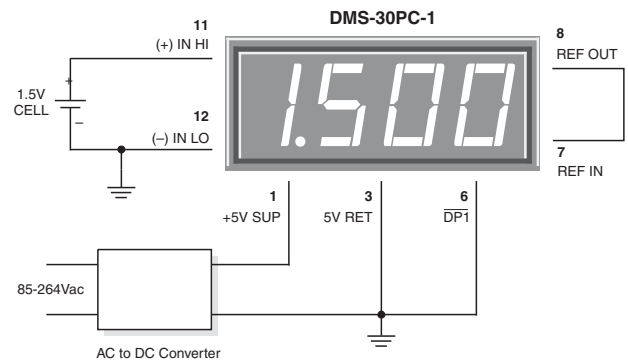

Figure 5. Floating Input Measurements

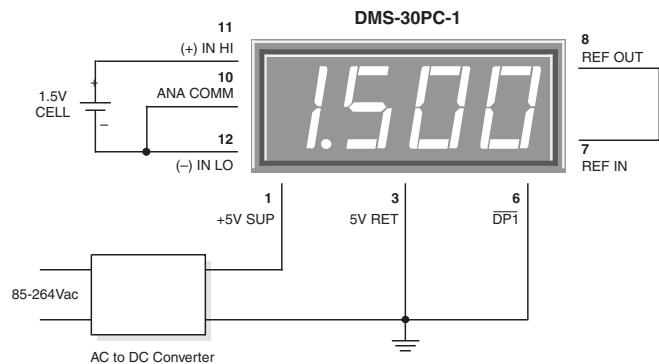

Figure 6. Floating Input Measurements (Alternate Configuration)

5. Process Control (4-to-20mA) Measurements: In many common process-control applications, a 4-to-20mA current loop is used to transmit information. Because DMS-30PC meters have such high input impedance, a simple shunt resistor across the meter's input can be used to convert the loop current to a voltage. See Figure 7. The value of the shunt resistor is a function of the scaling requirements of the particular application and can be calculated using the following equation:

$$R_{\text{shunt}} = R1 = V_{\text{FSr}} / I_{\text{FSr}}$$

Where: V_{FSr} = Full scale reading (in Volts)

I_{FSr} = Relative full scale current (in Amps)

APPLICATIONS

Example: For a meter with a 2V full scale input (1.999 full scale reading) and a desired display reading of "1000" (with an input of 20mA), $V_{FSR} = 1.000$ Volts

$$R_{Shunt} = 1.000V / (0.020 - 0.004)A$$

$$R_{Shunt} = 1.000V / 0.016A = 62.5 \text{ Ohms}$$

To calibrate the circuit of Figure 7, perform the following:

1. With 4mA applied, adjust the 50kΩ potentiometer (R2) to display a reading of "000" (assuming that is the desired reading).
2. With 20mA applied, adjust the gain-adjust potentiometer on the back of the meter to display a reading of "1000". For different full scale readings, alter the value of R_{Shunt} accordingly.

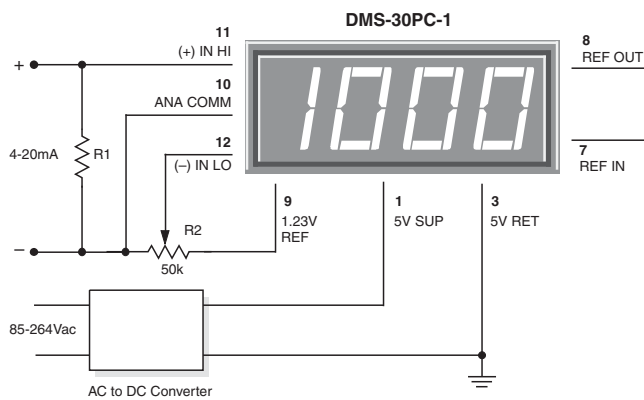

Figure 7. 4-to-20mA Current Loop Operation

6. Power Supply Monitoring: One of the most common digital panel meter applications involves monitoring the output voltage of the system power supply — often this supply also powers the meter itself. The low-power, red LED DMS-30PC-2-RL can be configured to allow power supply monitoring over the range of 4.5-18Vdc. The circuit in Figure 8 uses a low-drop-out, three-terminal regulator (LM-2931Z-5, available from National Semiconductor) to provide regulated 5V power to the meter. The LM-2931 was chosen because it has the following on-chip protection features: reverse polarity, short circuit

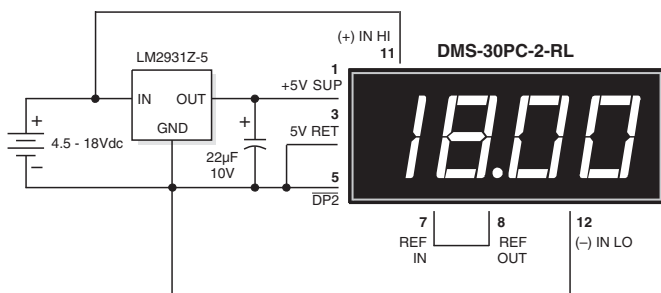

Figure 8. 4.5-18V Power Supply Monitor

and thermal run-away. When using other, higher-power, DMS-30PC models with three-terminal regulators, be sure to consult the regulator manufacturer's data sheet to ensure the regulator is being utilized safely and correctly.

7. Digital Ammeter: Digital ammeters are finding ever-increasing usage because analog-style ammeters (moving-vane types) now cost roughly the same as their digital counterparts. Additionally, analog ammeters are not nearly as rugged as modern digital panel voltmeters. Figure 9 illustrates a typical ammeter application. The circuit uses a ±200mV input meter

— the preferred range for most ammeters — to measure the voltage developed across a 0.1Ω current shunt. The circuit shown represents a basic ammeter connection diagram. A detailed application note describing digital dc ammeters is included in DATEL's new Digital Panel Meter Databook.

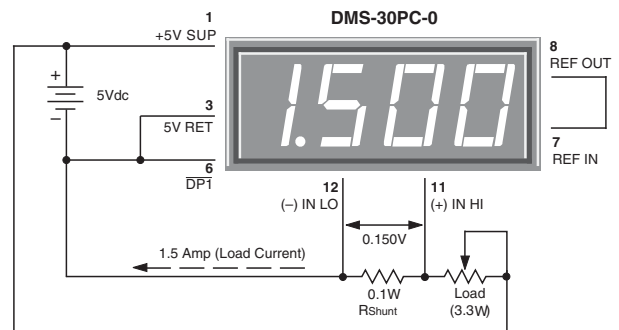

Figure 9. Basic DC Ammeter Circuit

8. External Gain Adjustment: Connect REFERENCE OUT (pin 8) to REFERENCE IN (pin 7) for normal, factory calibrated, operation. Use the +1.23V REFERENCE OUT (pin 9) for applications needing external gain adjustment. Figure 10 shows the wiring configuration for each model. Calibration is performed with a precise, near-full-scale, input voltage.

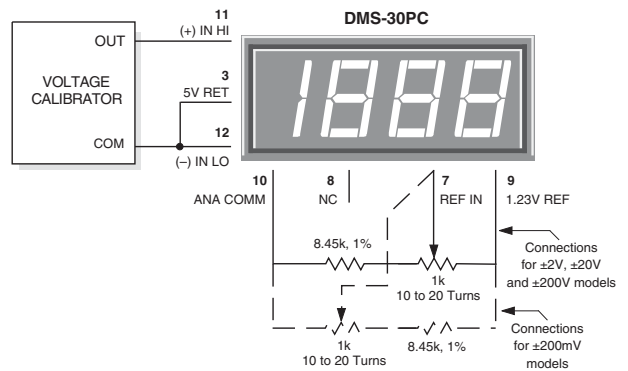

Figure 10. External Gain Adjustment

Компания «Океан Электроники» предлагает заключение долгосрочных отношений при поставках импортных электронных компонентов на взаимовыгодных условиях!

Наши преимущества:

- Поставка оригинальных импортных электронных компонентов напрямую с производств Америки, Европы и Азии, а так же с крупнейших складов мира;
- Широкая линейка поставок активных и пассивных импортных электронных компонентов (более 30 млн. наименований);
- Поставка сложных, дефицитных, либо снятых с производства позиций;
- Оперативные сроки поставки под заказ (от 5 рабочих дней);
- Экспресс доставка в любую точку России;
- Помощь Конструкторского Отдела и консультации квалифицированных инженеров;
- Техническая поддержка проекта, помощь в подборе аналогов, поставка прототипов;
- Поставка электронных компонентов под контролем ВП;
- Система менеджмента качества сертифицирована по Международному стандарту ISO 9001;
- При необходимости вся продукция военного и аэрокосмического назначения проходит испытания и сертификацию в лаборатории (по согласованию с заказчиком);
- Поставка специализированных компонентов военного и аэрокосмического уровня качества (Xilinx, Altera, Analog Devices, Intersil, Interpoint, Microsemi, Actel, Aeroflex, Peregrine, VPT, Syfer, Eurofarad, Texas Instruments, MS Kennedy, Miteq, Cobham, E2V, MA-COM, Hittite, Mini-Circuits, General Dynamics и др.);

Компания «Океан Электроники» является официальным дистрибьютором и эксклюзивным представителем в России одного из крупнейших производителей разъемов военного и аэрокосмического назначения «JONHON», а так же официальным дистрибьютором и эксклюзивным представителем в России производителя высокотехнологичных и надежных решений для передачи СВЧ сигналов «FORSTAR».



JONHON

«JONHON» (основан в 1970 г.)

Разъемы специального, военного и аэрокосмического назначения:

(Применяются в военной, авиационной, аэрокосмической, морской, железнодорожной, горно- и нефтедобывающей отраслях промышленности)

«FORSTAR» (основан в 1998 г.)

ВЧ соединители, коаксиальные кабели, кабельные сборки и микроволновые компоненты:

(Применяются в телекоммуникациях гражданского и специального назначения, в средствах связи, РЛС, а так же военной, авиационной и аэрокосмической отраслях промышленности).



Телефон: 8 (812) 309-75-97 (многоканальный)

Факс: 8 (812) 320-03-32

Электронная почта: ocean@oceanchips.ru

Web: <http://oceanchips.ru/>

Адрес: 198099, г. Санкт-Петербург, ул. Калинина, д. 2, корп. 4, лит. А