



**PIC24FJ256DA210
Development Board
User's Guide**

Note the following details of the code protection feature on Microchip devices:

- Microchip products meet the specification contained in their particular Microchip Data Sheet.
- Microchip believes that its family of products is one of the most secure families of its kind on the market today, when used in the intended manner and under normal conditions.
- There are dishonest and possibly illegal methods used to breach the code protection feature. All of these methods, to our knowledge, require using the Microchip products in a manner outside the operating specifications contained in Microchip's Data Sheets. Most likely, the person doing so is engaged in theft of intellectual property.
- Microchip is willing to work with the customer who is concerned about the integrity of their code.
- Neither Microchip nor any other semiconductor manufacturer can guarantee the security of their code. Code protection does not mean that we are guaranteeing the product as "unbreakable."

Code protection is constantly evolving. We at Microchip are committed to continuously improving the code protection features of our products. Attempts to break Microchip's code protection feature may be a violation of the Digital Millennium Copyright Act. If such acts allow unauthorized access to your software or other copyrighted work, you may have a right to sue for relief under that Act.

Information contained in this publication regarding device applications and the like is provided only for your convenience and may be superseded by updates. It is your responsibility to ensure that your application meets with your specifications. MICROCHIP MAKES NO REPRESENTATIONS OR WARRANTIES OF ANY KIND WHETHER EXPRESS OR IMPLIED, WRITTEN OR ORAL, STATUTORY OR OTHERWISE, RELATED TO THE INFORMATION, INCLUDING BUT NOT LIMITED TO ITS CONDITION, QUALITY, PERFORMANCE, MERCHANTABILITY OR FITNESS FOR PURPOSE. Microchip disclaims all liability arising from this information and its use. Use of Microchip devices in life support and/or safety applications is entirely at the buyer's risk, and the buyer agrees to defend, indemnify and hold harmless Microchip from any and all damages, claims, suits, or expenses resulting from such use. No licenses are conveyed, implicitly or otherwise, under any Microchip intellectual property rights.

Trademarks

The Microchip name and logo, the Microchip logo, dsPIC, KEELOQ, KEELOQ logo, MPLAB, PIC, PICmicro, PICSTART, PIC³² logo, rPIC and UNI/O are registered trademarks of Microchip Technology Incorporated in the U.S.A. and other countries.

FilterLab, Hampshire, HI-TECH C, Linear Active Thermistor, MXDEV, MXLAB, SEEVAL and The Embedded Control Solutions Company are registered trademarks of Microchip Technology Incorporated in the U.S.A.

Analog-for-the-Digital Age, Application Maestro, CodeGuard, dsPICDEM, dsPICDEM.net, dsPICworks, dsSPEAK, ECAN, ECONOMONITOR, FanSense, HI-TIDE, In-Circuit Serial Programming, ICSP, Mindi, MiWi, MPASM, MPLAB Certified logo, MPLIB, MPLINK, mTouch, Octopus, Omniscient Code Generation, PICC, PICC-18, PICDEM, PICDEM.net, PICKIT, PICtail, REAL ICE, rLAB, Select Mode, Total Endurance, TSHARC, UniWinDriver, WiperLock and ZENA are trademarks of Microchip Technology Incorporated in the U.S.A. and other countries.

SQTP is a service mark of Microchip Technology Incorporated in the U.S.A.

All other trademarks mentioned herein are property of their respective companies.

© 2010, Microchip Technology Incorporated, Printed in the U.S.A., All Rights Reserved.

 Printed on recycled paper.

ISBN: 978-1-60932-286-1

**QUALITY MANAGEMENT SYSTEM
CERTIFIED BY DNV
== ISO/TS 16949:2002 ==**

Microchip received ISO/TS-16949:2002 certification for its worldwide headquarters, design and wafer fabrication facilities in Chandler and Tempe, Arizona; Gresham, Oregon and design centers in California and India. The Company's quality system processes and procedures are for its PIC[®] MCUs and dsPIC[®] DSCs, KEELOQ[®] code hopping devices, Serial EEPROMs, microperipherals, nonvolatile memory and analog products. In addition, Microchip's quality system for the design and manufacture of development systems is ISO 9001:2000 certified.

Table of Contents

Preface	5
Chapter 1. Introducing the Development Board	
1.1 Introduction	11
1.2 Development Board Features	11
1.3 Power Requirements	13
1.4 Companion Display Boards	14
1.5 Typical Development Board Configurations	15
1.6 Development Board Demonstration Programs	15
1.7 Additional Software for Application Development	16
Chapter 2. The Demonstration Application	
2.1 Introduction	17
2.2 About the Application	17
Chapter 3. Programming and Debugging the Board	
3.1 Introduction	19
3.2 Tutorial overview	19
3.3 Loading the Project	20
3.4 Building the Code	22
3.5 Programming the PIC24FJ256DA210	23
3.6 Running the Code	26
3.7 Debugging the Code	27
Chapter 4. Development Board Hardware	
4.1 Introduction	31
4.2 Functional Overview	31
4.3 General Hardware Features	32
4.4 Setup and Configuration	34
Appendix A. Development Board Schematics	
A.1 Introduction	49
A.2 Hardware Features	49
A.3 Development Board Schematics	51
Appendix B. Modifications for PICtail Plus Daughter Boards	
B.1 Introduction	59
B.2 Overview of the PICtail Plus Interface	59
B.3 Modifications for Specific Daughter Boards	62
Index	63
Worldwide Sales and Service	64

PIC24FJ256DA210 Development Board User's Guide

NOTES:

Preface

NOTICE TO CUSTOMERS

All documentation becomes dated, and this manual is no exception. Microchip tools and documentation are constantly evolving to meet customer needs, so some actual dialogs and/or tool descriptions may differ from those in this document. Please refer to our web site (www.microchip.com) to obtain the latest documentation available.

Documents are identified with a “DS” number. This number is located on the bottom of each page, in front of the page number. The numbering convention for the DS number is “DSXXXXA”, where “XXXX” is the document number and “A” is the revision level of the document.

For the most up-to-date information on development tools, see the MPLAB® IDE on-line help. Select the Help menu, and then Topics to open a list of available on-line help files.

INTRODUCTION

This chapter contains general information that will be useful to know before using the PIC24FJ256DA210 Development Board. Items discussed in this chapter include:

- Document Layout
- Conventions Used in this Guide
- Recommended Reading
- The Microchip Web Site
- Training and Seminars
- Development Systems Customer Change Notification Service
- Customer Support
- Document Revision History

DOCUMENT LAYOUT

This document describes how to use the PIC24FJ256DA210 Development Board as a development tool to emulate and debug firmware on a target board. The manual layout is as follows:

- **Chapter 1. Introducing the Development Board** provides a brief overview of the PIC24FJ256DA210 Development Board, its features and its uses.
- **Chapter 2. The Demonstration Application** provides a brief overview of the interactive, touch-screen-based demo that ships with the development board.
- **Chapter 3. Programming and Debugging the Board** provides instructions for using MPLAB® IDE to create a project and program the development board.
- **Chapter 4. Development Board Hardware** provides a detailed description of the development board's features and instructions on their configuration.
- **Appendix A. Development Board Schematics** provides the schematics and other technical details.
- **Appendix B. Modifications for PICtail Plus Daughter Boards** provides specific directions for adapting the development board to interface with daughter boards.

PIC24FJ256DA210 Development Board User's Guide

CONVENTIONS USED IN THIS GUIDE

This manual uses the following documentation conventions:

DOCUMENTATION CONVENTIONS

Description	Represents	Examples
Arial font:		
Italic characters	Referenced books	<i>MPLAB[®] IDE User's Guide</i>
	Emphasized text	...is the <i>only</i> compiler...
Initial caps	A window	the Output window
	A dialog	the Settings dialog
	A menu selection	select Enable Programmer
Quotes	A field name in a window or dialog	"Save project before build"
Underlined, italic text with right angle bracket	A menu path	<u><i>File>Save</i></u>
Bold characters	A dialog button	Click OK
	A tab	Click the Power tab
Text in angle brackets < >	A key on the keyboard	Press <Enter>, <F1>
Courier New font:		
Plain Courier New	Sample source code	<code>#define START</code>
	Filenames	<code>autoexec.bat</code>
	File paths	<code>c:\mcc18\h</code>
	Keywords	<code>_asm, _endasm, static</code>
	Command-line options	<code>-Opa+, -Opa-</code>
	Bit values	<code>0, 1</code>
	Constants	<code>0xFF, 'A'</code>
Italic Courier New	A variable argument	<i>file.o</i> , where <i>file</i> can be any valid filename
Square brackets []	Optional arguments	<code>mcc18 [options] file [options]</code>
Curly brackets and pipe character: { }	Choice of mutually exclusive arguments; an OR selection	<code>errorlevel {0 1}</code>
Ellipses...	Replaces repeated text	<code>var_name [, var_name...]</code>
	Represents code supplied by user	<code>void main (void) { ... }</code>

RECOMMENDED READING

This user's guide describes how to use PIC24FJ256DA210 Development Board. Other useful documents are listed below. The following Microchip documents are available and recommended as supplemental reference resources.

PIC24FJ256DA210 Data Sheet (DS39969)

Consult this document for detailed information on the PIC24FJ256DA210 microcontroller with integrated graphics controller. Reference information found in this data sheet includes:

- Device memory map
- Device pinout and packaging details
- Device electrical specifications
- List of peripherals included on the device

PIC24F Family Reference Manual

This reference manual explains the operation of the PIC24F microcontroller family architecture and peripheral modules. The specifics of each device family are discussed in the individual family's device data sheet. This useful manual is online located in the Technical Documentation section of the Microchip web site. Refer to these for detailed information on PIC24F device operation.

MPLAB[®] ASM30, MPLAB[®] LINK30 and Utilities User's Guide (DS51317)

This document helps you use Microchip's language tools for PIC24F devices based on GNU technology. The language tools discussed are the MPLAB ASM30 Assembler, MPLAB LINK30 Linker, MPLAB LIB30 Archiver/Librarian and other 16-bit device utilities.

MPLAB[®] C30 C Compiler User's Guide (DS51284)

This document helps you use Microchip's MPLAB C30 C compiler to develop your application. MPLAB C30 is a GNU-based language tool, based on source code from the Free Software Foundation (FSF). For more information about FSF, see www.fsf.org.

MPLAB[®] IDE User's Guide (DS51519)

This document describes how to use the MPLAB Integrated Development Environment (IDE), as well as the MPLAB IDE Project Manager, MPLAB IDE Editor and MPLAB SIM Simulator. Use these development tools to help you develop and debug application code.

MPLAB[®] IDE Simulator, Editor User's Guide (DS51025)

Consult this document for more information pertaining to the installation and implementation of the MPLAB IDE software.

Graphics Solutions and Capacitive mTouch[™] Sensing Documentation

The Microchip web site provides a wealth of information for developing microcontroller-based solutions using graphics and touch sensing. Application notes and software libraries are available to help design and implement applications. Refer to www.microchip.com/graphics and www.microchip.com/mtouch for more information.

PIC24FJ256DA210 Development Board User's Guide

THE MICROCHIP WEB SITE

Microchip provides online support via our web site at www.microchip.com. This web site is used as a means to make files and information easily available to customers. Accessible by using your favorite Internet browser, the web site contains the following information:

- **Product Support** – Data sheets and errata, application notes and sample programs, design resources, user's guides and hardware support documents, latest software releases and archived software
- **General Technical Support** – Frequently Asked Questions (FAQs), technical support requests, online discussion groups, Microchip consultant program member listing
- **Application and Market Support** – Specific information on Microchip's latest solutions for targeted vertical markets and hardware solutions, including ready-to-use application libraries to support the latest hardware
- **Business of Microchip** – Product selector and ordering guides, latest Microchip press releases, listing of seminars and events, listings of Microchip sales offices, distributors and factory representatives

TRAINING AND SEMINARS

Microchip offers classes and training in Regional Training Centers (RTCs) conveniently located worldwide. The RTCs offer a variety of highly-targeted design topics that can help in creating new applications, adding functionality to existing applications, or taking full advantage of new and unfamiliar device peripherals on PIC devices and dsPIC[®] DSCs. These classes can help in keeping current in the competitive and always changing world of embedded design, and stay ahead of industry trends and design techniques. Visit the RTC web site at www.microchip.com/rtc site for details on offered classes.

In addition, Microchip also offers various a wide-ranging line of online webinars that are available at all times. For those users who may not have the ability to attend a class in person, or the time to wait for a class to be offered, these provide a convenient alternative that is available on your schedule. For more information, visit the web sites www.microchip.com/webinars.

DEVELOPMENT SYSTEMS CUSTOMER CHANGE NOTIFICATION SERVICE

Microchip's customer notification service helps keep customers current on Microchip products. Subscribers will receive e-mail notification whenever there are changes, updates, revisions or errata related to a specified product family or development tool of interest.

To register, access the Microchip web site at www.microchip.com, click on Customer Change Notification and follow the registration instructions.

The Development Systems product group categories are:

- **Compilers** – The latest information on Microchip C compilers and other language tools. These include the MPLAB C18 and MPLAB C30 C compilers; MPASM™ and MPLAB ASM30 assemblers; MPLINK™ and MPLAB LINK30 object linkers; and MPLIB™ and MPLAB LIB30 object librarians.
- **Emulators** – The latest information on Microchip in-circuit emulators, such as the MPLAB ICE 4000.
- **In-Circuit Debuggers** – The latest information on the Microchip in-circuit debuggers, MPLAB ICD 3 and MPLAB REAL ICE.
- **MPLAB® IDE** – The latest information on Microchip MPLAB IDE, the Windows® Integrated Development Environment for development systems tools. This list is focused on the MPLAB IDE, MPLAB SIM simulator, MPLAB IDE Project Manager and general editing and debugging features.
- **Programmers** – The latest information on Microchip programmers. These include the MPLAB PM3 and PRO MATE II device programmers and the PICSTART® Plus, PICKit™ 3, MPLAB ICD 3 and MPLAB REAL ICE™ development programmers.

CUSTOMER SUPPORT

Users of Microchip products can receive assistance through several channels:

- Distributor or Representative
- Local Sales Office
- Field Application Engineer (FAE)
- Technical Support

Customers should contact their distributor, representative or field application engineer (FAE) for support. Local sales offices are also available to help customers. A listing of sales offices and locations is included in the back of this document.

Technical support is available through the web site at: <http://support.microchip.com>

DOCUMENT REVISION HISTORY

Revision A (June 2010)

- Initial Release of this Document.

PIC24FJ256DA210 Development Board User's Guide

NOTES:

Chapter 1. Introducing the Development Board

1.1 INTRODUCTION

The PIC24FJ256DA210 Development Board is an efficient, low-cost development platform to evaluate the features and performance of Microchip's PIC24FJ256DA210 microcontroller. The 16-bit microcontroller integrates a high-performance graphics controller, CTMU and USB OTG modules essential for integrated human interface applications. Supporting this is a range of user-defined interfaces, USB options and memory expansions for the maximum flexibility in developing graphics-capable solutions. A range of Microchip development tools and software environments, along with a range of application libraries, simplifies the process of software development.

Topics discussed in this chapter include:

- Development Board Features
- Power Requirements
- Companion Display Panels
- Typical Development Board Configurations
- Development Board Demonstration Programs
- Additional Software for Application Development

1.2 DEVELOPMENT BOARD FEATURES

The PIC24FJ256DA210 Development Board, shown in Figure 1-1, incorporates a range of features to enhance its usefulness as a platform for developing graphics applications. Key features are identified in Figure 1-2.

FIGURE 1-1: PIC24FJ256DA210 DEVELOPMENT BOARD

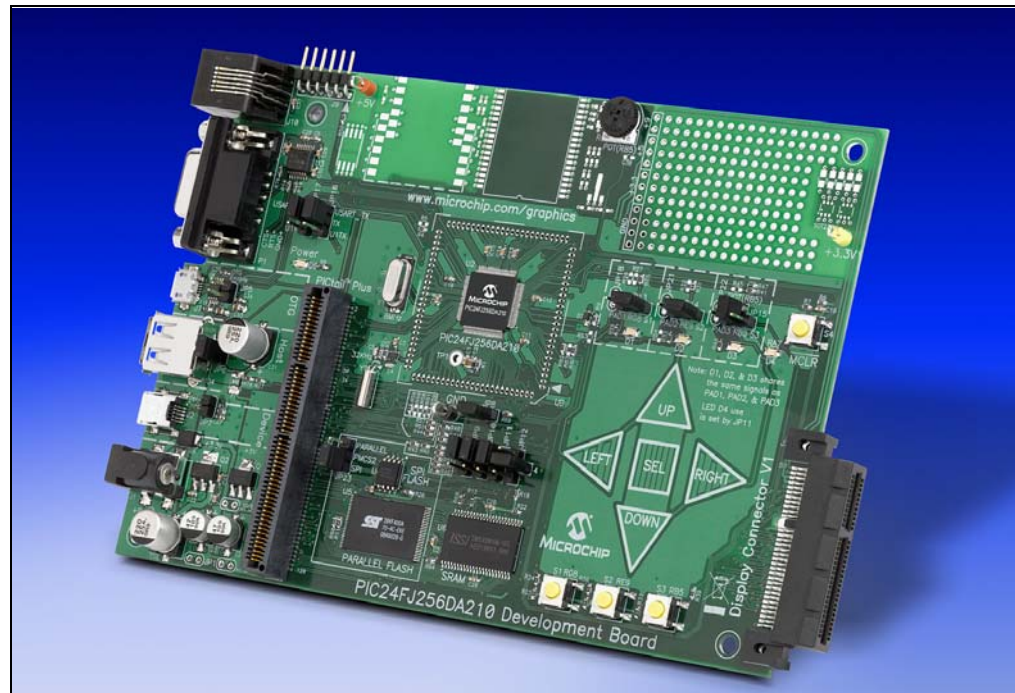

PIC24FJ256DA210 Development Board User's Guide

FIGURE 1-2: PIC24FJ256DA210 DEVELOPMENT BOARD LAYOUT

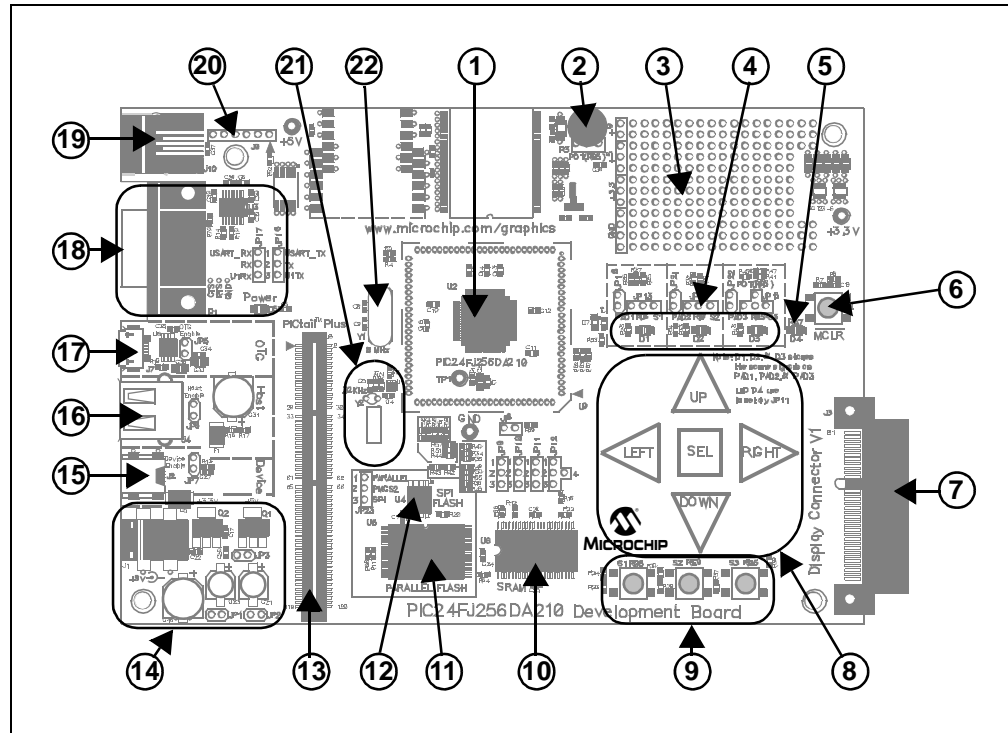

1. PIC24FJ256DA210 Microcontroller (U2)
2. Potentiometer for analog input (R3)
3. Prototyping area
4. Three red user-defined LEDs, multiplexed with (8) and (9) (D1, D2 and D3)
5. Red user-defined LED on PMA17 address line (D4)
6. MCLR Reset Button (S4)
7. Microchip Display Connector V1 (J3)
8. Capacitive touch pads
9. Push button switches (S1, S2 and S3)
10. On-board 512 Kbyte SRAM (U6)
11. On-board 512 Kbyte Flash Memory (U5)
12. On-board 16 Mbit (2 Mbyte) SPI Flash Memory (U4)
13. PICtail™ Plus 120-pin expansion connector (J8)
14. On board 5V and 3.3V regulators for external 9V input (Q1 and Q2), and green LED power indicator (D6)
15. USB device mode interface (J2)
16. USB Host mode interface (J4)
17. USB On-The-Go mode interface (J7)
18. RS-232 (DB-9F) serial port and associated hardware (P1)
19. RJ-11 ICD programming/debugging connector (J10)
20. PICkit™ ICSP™ programming/debugging connector (J9)
21. 32.72 kHz secondary oscillator circuit (Y2 and U1)
22. 8 MHz crystal for primary microcontroller clock (Y1)

Introducing the Development Board

1.2.1 PIC24FJ256DA210 Microcontroller

At the heart of the PIC24FJ256DA210 Development Board is the PIC24FJ256DA210 microcontroller. This microcontroller comes with a 16-bit core along with integrated graphics controller, as well as a wide range of peripherals.

The graphics controller is capable of running TFT, MSTN and CSTN display panels with resolution of up to QVGA (320x240) or WQVGA (480x272) at color depths of 16 bits per pixel (bpp), and VGA (640x480) running at 8 bpp. QVGA resolution can be run with the microcontroller's internal 96 Kbyte of RAM at 8 bpp. Refer to the "*PIC24FJ256DA210 Family Data Sheet*" (DS39969) for details.

1.2.2 Graphics Interface

The development board uses Microchip's standardized 64-pin edge connector to interface with compatible display boards. Both TFT and STN display boards can be accommodated, as well as many forms of resistive touch screen interfaces. Please refer to **Section 4.4.4 "Graphics Port"** for more details.

1.2.3 USB Options

As part of its standard peripheral set, the PIC24FJ256DA210 microcontroller supports full-speed USB operations with an on-chip controller and bus transceiver. In addition to Device mode operations, the USB controller supports Host and On-The-Go (dual-role) modes. The appropriate separate receptacles are provided for the required cable for each mode. Note, however, that only one of the USB modes can be active at any time.

1.2.4 Peripheral Options

Beyond the graphics and USB interfaces, the development board is equipped with an extensive set of additional features for hardware application development. User-defined push button switches, CTMU-based touch sensors, LEDs, serial communications, and several varieties of external memory are provided to give the developer a full range of hardware options. Please refer to **Chapter 4. "Development Board Hardware"** for a complete discussion.

1.2.5 PICtail Plus Connector

The PICtail Plus connector makes it possible to connect to a range of PICtail Plus Daughter Boards, thus adding new functionality to an application under development. The connector can be configured for different signal routings to accommodate different daughter boards. Please refer to **Section 4.4.6 "PICtail™ Plus Card Modular Expansion Connector"** for more information.

1.3 POWER REQUIREMENTS

The PIC24FJ256DA210 Development Board can be powered from an external power supply, or by applying power directly to test points on the board itself. For simplicity, an unregulated 9V power supply is recommended (such as Microchip part number AC162039).

Care must be observed when connecting customized displays. The on-board regulators can supply up to 800 mA current combined. A separate external power supply may be needed for bigger displays. Please refer the chosen display panel power requirements for details.

PIC24FJ256DA210 Development Board User's Guide

1.4 COMPANION DISPLAY BOARDS

The PIC24FJ256DA210 Development Board is compatible with all of the graphic display panels shown in Figure 1-3. The demo code that is pre-programmed onto the development board is designed to work with the Graphics Display Truly 3.2" 240x320 Board. The Graphics Display Prototype Board (AC164139) can be used to connect a different display panel.

The development board has been designed to be compatible with any future Microchip display panel products. Compatible display panels will have a 64-pin edge connector that matches the RGB Display Connector (V1). The most current list of display panels is available at the Microchip web site.

FIGURE 1-3: MICROCHIP GRAPHIC DISPLAY BOARDS

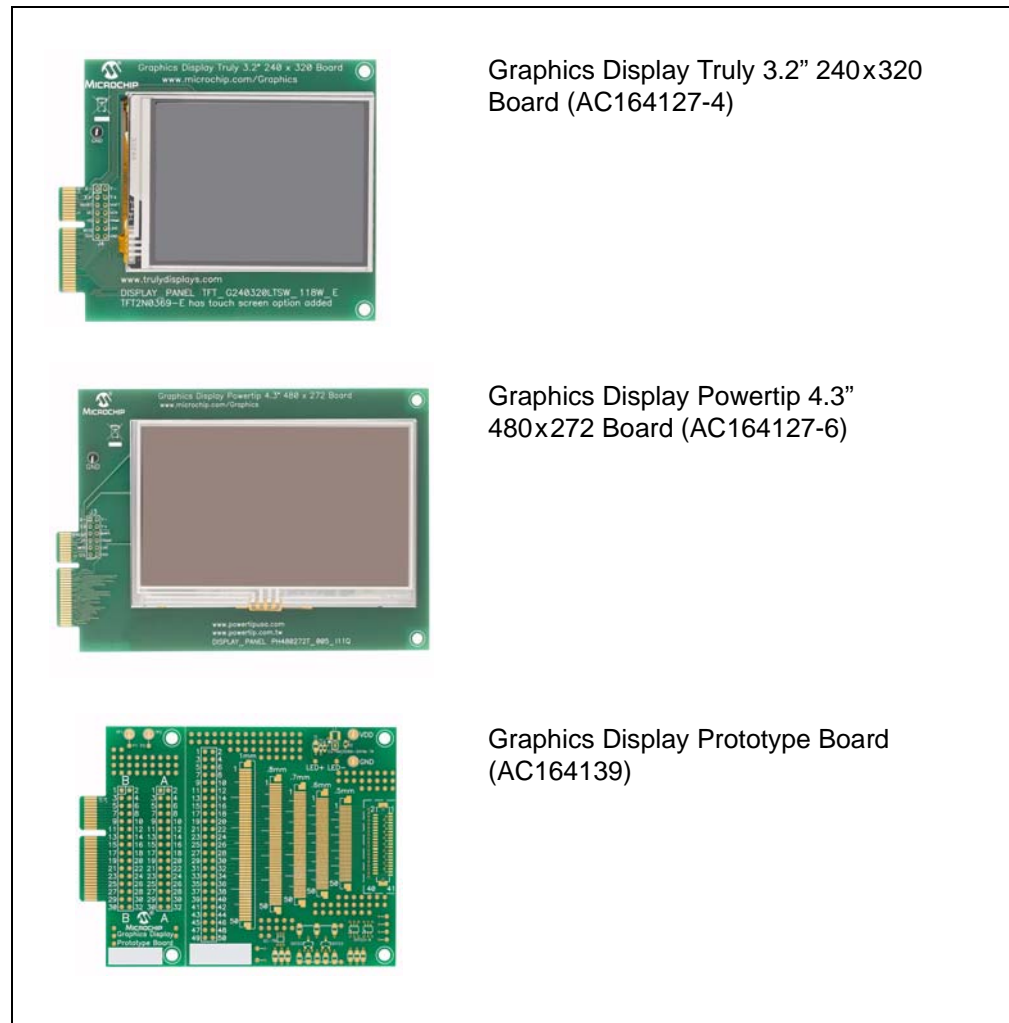

Introducing the Development Board

1.5 TYPICAL DEVELOPMENT BOARD CONFIGURATIONS

The typical connections to use the development board as shipped from the factory are shown in Figure 1-4. To run the pre-programmed demo application:

1. Connect the Truly 3.2" Display Board display into Display Connector V1 (depending on the development board kit ordered, this may or may not be included with the development board)
2. Plug a 9V power supply into J1

To program the board for application development, use one of the two programming ports provided:

- J10, a 6-wire RJ-11 jack (for use with MPLAB ICD 3 and MPLAB REAL ICE programmers)
- J9, a 6-pin riser (for use with the PICkit 3 programmer)

See **Section 4.3.5 “Programming and Debugging Interface”** for additional details on the programming ports.

FIGURE 1-4: TYPICAL BOARD CONFIGURATION

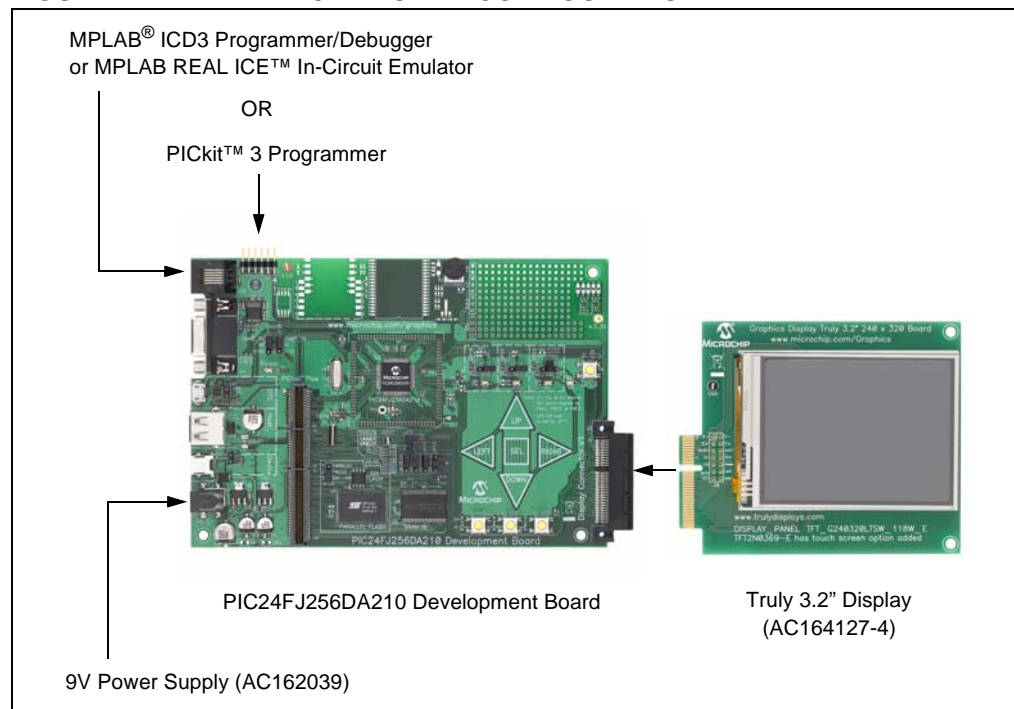

1.6 DEVELOPMENT BOARD DEMONSTRATION PROGRAMS

The development board is pre-programmed with a demo application designed for the Truly 3.2" Display Board. The application automatically runs when power is applied to the board, and shows various Microchip Application Libraries integrated into a single application. The demo is described in more detail in **Chapter 2. “The Demonstration Application”**.

The application can be reconfigured to run on other display panels. To do this, the board must be reprogrammed with the proper HEX file. For directions on reprogramming the development board, see **Section Chapter 3. “Programming and Debugging the Board”**.

Additional demonstration programs are provided with the Microchip Graphics Library, discussed in the following section. Refer to the Graphics Library Help file for details on how to download and run the additional demo applications.

PIC24FJ256DA210 Development Board User's Guide

1.7 ADDITIONAL SOFTWARE FOR APPLICATION DEVELOPMENT

The demo application that ships with the PIC24FJ256DA210 Development Board only demonstrates part of the microcontroller's capabilities. To take full advantage of the microcontroller and the development platform, download and install these software tools from the Microchip web site (if you don't already have them):

- A Microchip development environment, such as the latest version of MPLAB IDE
- A C compiler for PIC24 microcontrollers, such as the MPLAB C30 compiler
- One or more of the specialized Microchip Application Libraries

1.7.1 The Microchip Application Libraries

Microchip Application Libraries (MALs) provide developers the ability to quickly develop applications for their products. MALs contain different libraries and stacks supporting connectivity, communication interfacing and user interfaces.

For example, using the Microchip Graphics Library provides ready-made library objects and drivers. Adding connectivity to applications is simplified with the MCHPFSUSB Library (full-speed USB) and/or the Microchip TCP/IP Stack. All of these stacks and libraries also come with their own demo software and examples, aiding users on how to integrate these software components into their applications.

Some of the available Application Libraries that will be useful in developing applications for the development board include:

- Microchip Graphics Library
- MCHPFSUSB Library
- mTouch™ Capacitive Library
- Microchip Memory Disk Drive (MDD) File System Interface Library
- Microchip TCP/IP Stack (with the addition of optional hardware)

Refer to the individual application library web page and documentation for details.

Chapter 2. The Demonstration Application

2.1 INTRODUCTION

This chapter provides a brief overview of the pre-programmed graphics demonstration application that is provided with the PIC24FJ256DA210 Development Board.

2.2 ABOUT THE APPLICATION

The pre-programmed demonstration application has been designed as a showcase for the PIC24FJ256DA210 microcontroller. The full-color graphics and resistive touch-screen management are all handled on-chip using the microcontroller. Only a subset of the development board's other interactive features are demonstrated in this application.

The demonstration runs from two main menu screens (Figure 2-1 and Figure 2-2), with Figure 2-1 appearing on power-up as the default screen. Navigation between the two menu screens is done with the arrows in the screen's lower right corner.

A total of 10 interactive demos are provided in the application. Touching the appropriate icon invokes that demo. Touching the "Demo" button in the lower left of either menu screen runs a continuous loop of several of the demos. Touching "Exit", generally in the lower left of any of the demos, returns to the menu screen.

FIGURE 2-1: DEMO APPLICATION, FIRST MENU SCREEN



The demos available on the first screen are:

- **Lighting:** this demonstrates a lighting control terminal application. Using the touch screen, sliders and buttons are provided to vary the red, green and blue lighting colors.

PIC24FJ256DA210 Development Board User's Guide

- Language: this shows how multiple languages can be integrated into one application. Text examples in Roman, Cyrillic, simplified Chinese, Japanese and Korean alphabets are shown.
- Game: this is a simple, interactive adaptation of a “snake” video game. Its operation is self-explanatory.
- Animation: this shows animation of stored graphics, along with image scaling and interactivity.
- Drawing: this demo implements free-hand drawing with a selectable color palette using the touch screen.
- ECG: this simulates an electrocardiogram display, demonstrating how analog data can be used to produce a graphic output. The “Ext” option switches between the fixed ECG display and a graphing display based on the potentiometer's position.

FIGURE 2-2: DEMO APPLICATION, SECOND MENU SCREEN

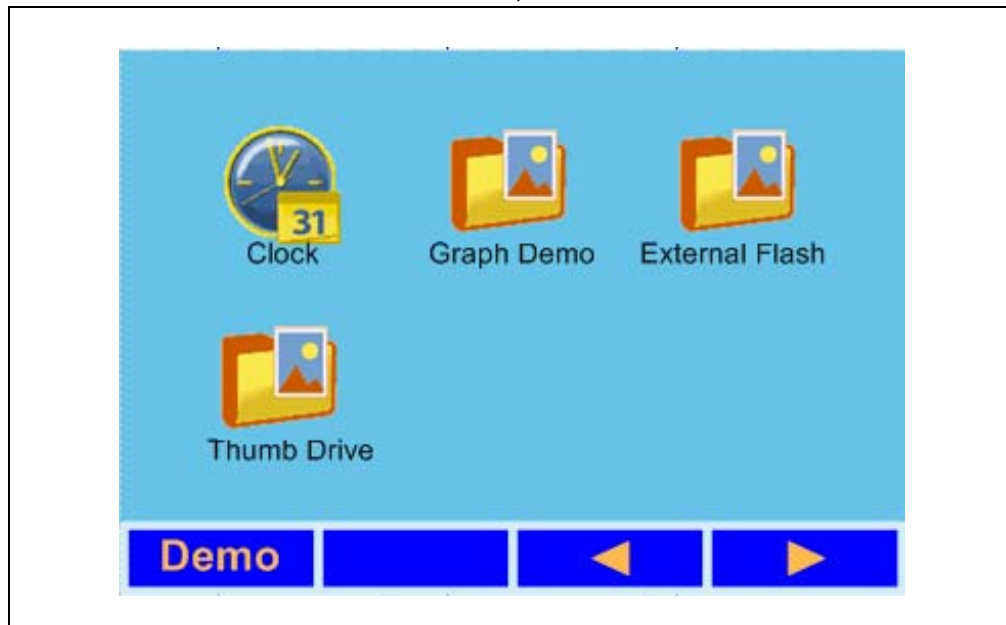

The demos available from the second screen are:

- Clock: this is a simple numeric date and time display, based on the microcontroller's RTCC.
- Graph Demo: this demo uses the Chart widget from the Microchip Graphics Library to generate a wide range of bar and pie charts based on a fixed set of data.
- External Flash: this demo shows images or pictures stored in the on-board Flash memory.
- Thumb Drive: this uses the USB Host interface to read a thumb drive connected to J4 and scan it for graphics files (JPEG or BMP formats only). The application then produces a directory of graphics images, and displays the corresponding file when selected.

2.2.1 Other Considerations

The demonstration application described here is the most current version as of the date of original publication of the user's guide. Microchip Technology reserves the right to update this application and its appearance in future releases of the development board kit.

Chapter 3. Programming and Debugging the Board

3.1 INTRODUCTION

The PIC24FJ256DA210 Development Board may be used with MPLAB IDE, the free integrated development environment available on Microchip's website. MPLAB IDE with Microchip's compatible programming/debugging hardware allows the development board to be programmed and/or debugged.

For more information on how to use the MPLAB IDE, please refer to the following documentation:

- MPLAB IDE User's Guide (DS51519)
- MPLAB IDE Quick Start Guide (DS51281)
- MPLAB IDE Online Help

This chapter includes the following:

- Tutorial Overview
- Loading the Project
- Building the Code
- Programming the PIC24FJ256DA210
- Running the Code
- Debugging the Code

3.2 TUTORIAL OVERVIEW

Creating projects with the Microchip Graphics Library requires that a number of files be included in the project. It is much more efficient to start a new project based on an existing demo application release with the Microchip Graphics Library. The tutorial in this chapter uses that route to guide development of new applications. All demo applications are written in C for MPLAB C30.

Note: This tutorial was developed using MPLAB IDE v8.40 and MPLAB C30 Compiler v3.30 as the software tools, and the Microchip Graphics Applications Library v2.10. Before proceeding, verify that you have at least these revision levels.

The Demonstration Applications are provided with the Microchip Applications Library downloadable from <http://www.microchip.com/mal>. When installed in a specified path (for example, C:\Microchip Solutions\), the help file Graphics Library Help.chm is located in the path C:\Microchip Solutions\Microchip\Help\Graphics Library Help.chm. The help file contains the Graphics Library release notes and description of the API. It also contains useful information on the demo applications that can run on the development board.

PIC24FJ256DA210 Development Board User's Guide

Upon completing this tutorial, you should be able to:

- Load an existing project in MPLAB IDE
- Assemble and link the loaded project
- Debug the loaded project
- Program the PIC24FJ256DA210 with MPLAB REAL ICE in-circuit emulator or MPLAB ICD 3.

3.3 LOADING THE PROJECT

After installing the Microchip Graphics Library and the Demo Applications that are released with the library, load one of the demo applications to MPLAB IDE:

1. Launch MPLAB IDE.
2. Close any workspace that might be open (*File > Close Workspace*).
3. From the *Project* menu, select *Open*.
4. Browse through the directories to get to one of the several demo applications. The factory pre-programmed application is located in the path: C:\Microchip Solutions\Graphics MultiApp Demo\GMAP USB Demo PIC24.mcp. Click **Open**.

FIGURE 3-1: LOADING THE PROJECT

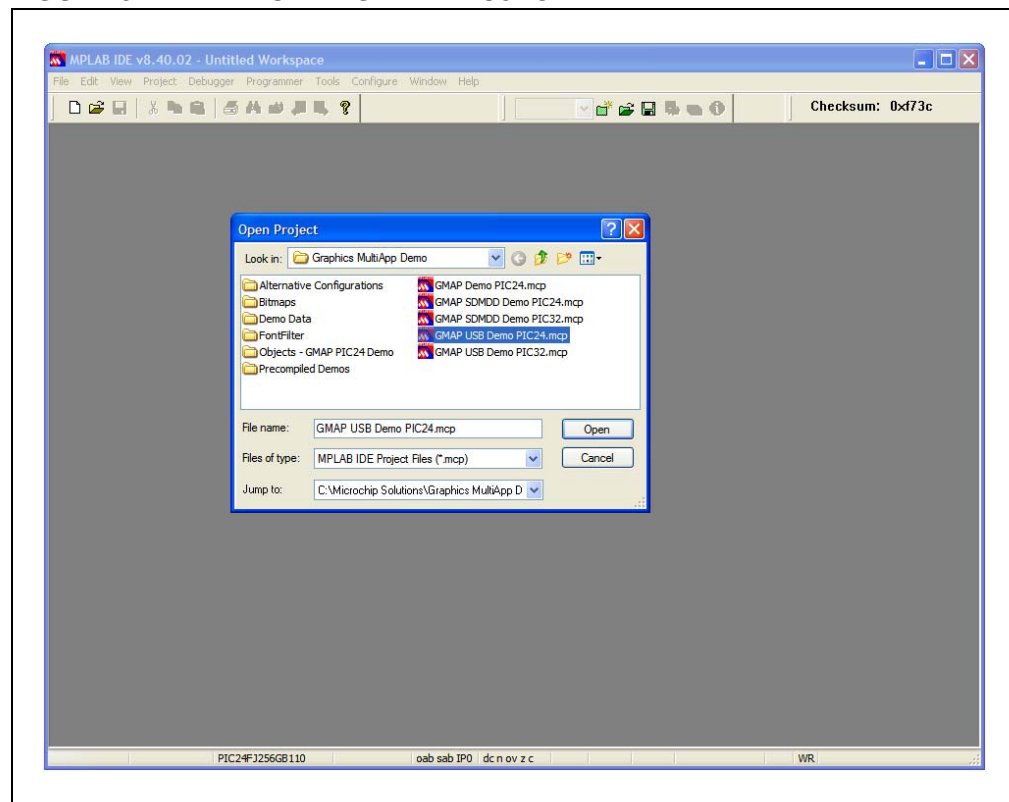

5. From the *Configure* menu, choose *Select Device*.
6. From the **Device** drop down list, select "PIC24FJ256DA210" (Figure 3-2). Click **OK** to select the device. The loaded project will be set to use MPLAB C30 compiler.

Programming and Debugging the Board

FIGURE 3-2: SET DEVICE

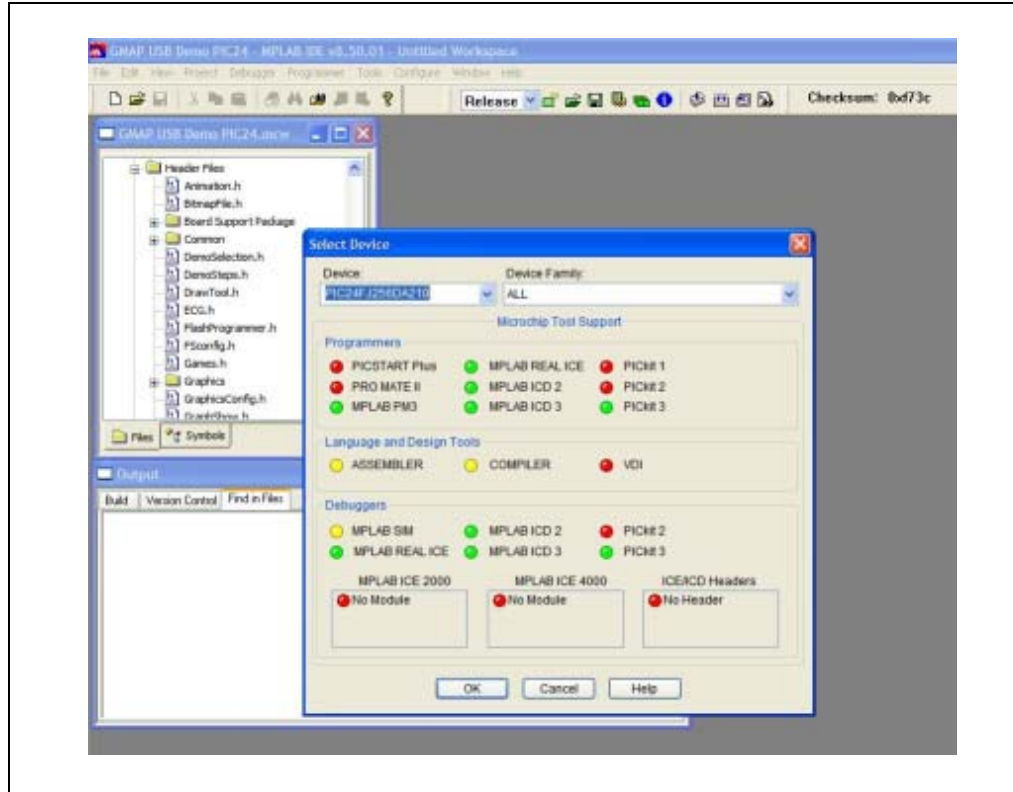

7. Before you build the project, verify that the display panel to be used is the same one included in the code project:
 - a) On the Project Window select and open the file `HardwareProfile.h`. (Figure 3-3).
 - b) Select the appropriate header file for the display board to be used. Refer to the Graphics Library help file for more information on selecting the hardware profile. Refer to the “Demo Compatibility Guide” under the “Demo Projects” section.

FIGURE 3-3: SET CORRECT DISPLAY BOARD

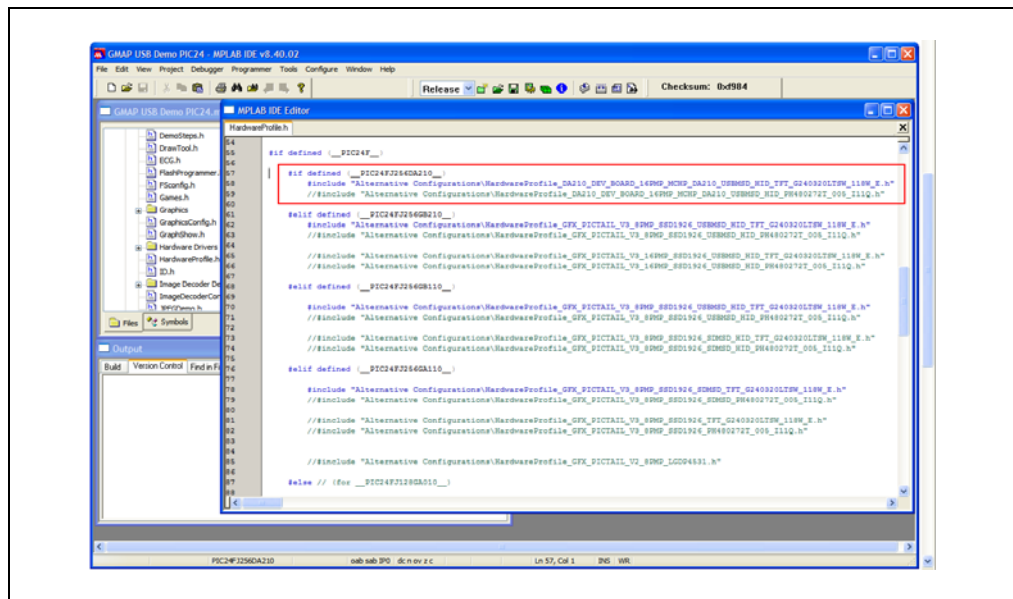

PIC24FJ256DA210 Development Board User's Guide

3.4 BUILDING THE CODE

For the loaded project, building the code consists of compiling the source files to create an object file, `GMAP_USB_Demo_PIC24.o`, then linking the object file to create the output files `GMAP_USB_Demo_PIC24.hex` and `GMAP_USB_Demo_PIC24.cof`. The HEX file contains the data necessary to program the device, and the `.cof` file contains additional information that lets you debug the code at the source code level.

3.4.1 Verifying the Compiler Path

Before building the project, check that the path of the MPLAB C30 compiler is set to the correct path. The path must be consistent with the location of the compiler when you installed it.

1. At the *Project* menu, click on *Select Language Tool Suite...*. This opens the Select Language Toolsuite dialog (Figure 3-4).
2. Verify that the C30 Toolsuite is selected in the **Active Toolsuite** list. In the **Toolsuite Contents** list, select each item, then verify the path for that item in the **Location** box. If necessary, modify the path by clicking on **Browse**, then browsing to and selecting the correct location in the dialog that follows.
3. After verifying and/or modifying the paths, click **OK** to exit.

FIGURE 3-4: SELECT LANGUAGE TOOLSUITE

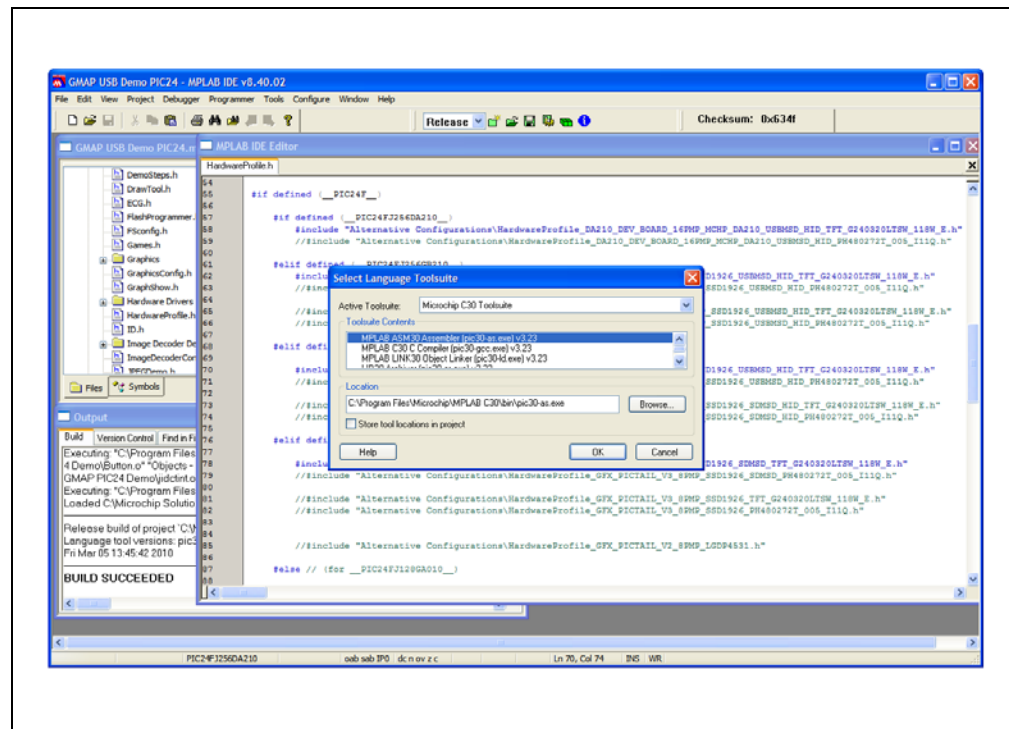

3.4.2 Building the Project

Before building the project, set the build for a release version. From the menu bar of the main MPLAB IDE window, select *Project > Build Configuration*, then select **Release**.

To build the project in the main MPLAB IDE window, select *Project > Make*. The Build Output window appears (Figure 3-5).

Observe the progress of the build. When the “BUILD SUCCEEDED” message displays, you are ready to program the device.

PIC24FJ256DA210 Development Board User's Guide

FIGURE 3-6: PIC24FJ256DA210 DEVELOPMENT BOARD CONFIGURATION BITS

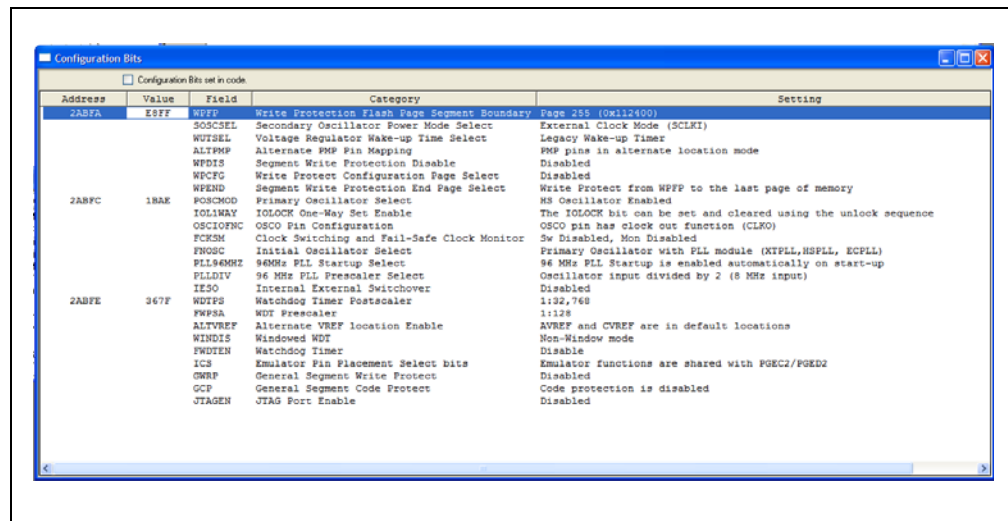

Address	Value	Field	Category	Setting
2ABFA	ESFF	WPFF	Write Protection Flash Page Segment Boundary	Page 255 (0x112400)
		SOOSCSEL	Secondary Oscillator Power Mode Select	External Clock Mode (SCLKI)
		WUTSEL	Voltage Regulator Wake-up Time Select	Legacy Wake-up Timer
		ALTPMP	Alternate PMP Pin Mapping	PMP pins in alternate location mode
		WDDIS	Segment Write Protection Disable	Disabled
		WPCFG	Write Protect Configuration Page Select	Disabled
		WFEND	Segment Write Protection End Page Select	Write Protect from WPFF to the last page of memory
2ABFC	1BAE	POSCMOD	Primary Oscillator Select	HS Oscillator Enabled
		IOLOCK	IOLOCK One-Way Set Enable	The IOLOCK bit can be set and cleared using the unlock sequence
		OSCIOPNC	OSCO Pin Configuration	OSCO pin has clock out function (CLKO)
		FCRSM	Clock Switching and Fail-Safe Clock Monitor	Sw Disabled, Mon Disabled
		FNOSC	Initial Oscillator Select	Primary Oscillator with PLL module (NTPLL, NSPLL, ECPPL)
		PLL96MHZ	96MHz PLL Startup Select	96 MHz PLL Startup is enabled automatically on start-up
		PLLDIV	96 MHz PLL Prescaler Select	Oscillator input divided by 2 (8 MHz input)
		IESO	Internal External Switchover	Disabled
2ABFE	267F	WDTPS	Watchdog Timer Postscaler	1:32,768
		FWP3A	WDT Prescaler	1:128
		ALTVREF	Alternate VREF location Enable	AVREF and CVREF are in default locations
		WINDES	Windowed WDT	Non-Window mode
		FWWEN	Watchdog Timer	Disable
		ICS	Emulator Pin Placement Select bits	Emulator functions are shared with FQEC2/FQED2
		OWRP	General Segment Write Protect	Disabled
		CCP	General Segment Code Protect	Code protection is disabled
		JTAGEN	JTAG Port: Enable	Disabled

Note: Do not use the Configuration Bits window to set device configuration if configuration macros are already used in the source code. To do this, check the “Configuration Bits set in code” checkbox at the top of the Configuration bits window. Refer to the “MPLAB IDE Simulator, Editor User’s Guide” (DS51025) for additional information.

3.5.2 Connect and Enable MPLAB REAL ICE In-Circuit Emulator

1. Connect the MPLAB REAL ICE in-circuit emulator module to the PC with the USB cable.
2. Connect the MPLAB REAL ICE in-circuit emulator to the PIC24FJ256DA210 Development Board with the short RJ-11 cable.
3. Apply power to the development board.
4. From the Debugger menu, choose *Select Tool > REAL ICE* to set MPLAB REAL ICE in-circuit emulator as the debug tool in MPLAB IDE.

Once selected, MPLAB IDE will connect to the MPLAB REAL ICE in-circuit emulator and report that it has detected the module (Figure 3-7). Then it connects to the MPLAB REAL ICE in-circuit emulator verifying the firmware loaded on the module is appropriate for the selected device (PIC24FJ256DA210). If not, it will load the necessary firmware. Once the firmware is verified to be correct it connects to the development board and determines if the target device (i.e., the PIC24FJ256DA210) is present or not.

Note: Upon first connection to the PIC24FJ256DA210 Development Board, MPLAB IDE may need to download new firmware. Allow it to do so. If any errors are shown, double click the error message to get more information.

Programming and Debugging the Board

FIGURE 3-7: ENABLING MPLAB® REAL ICE™ IN-CIRCUIT EMULATOR

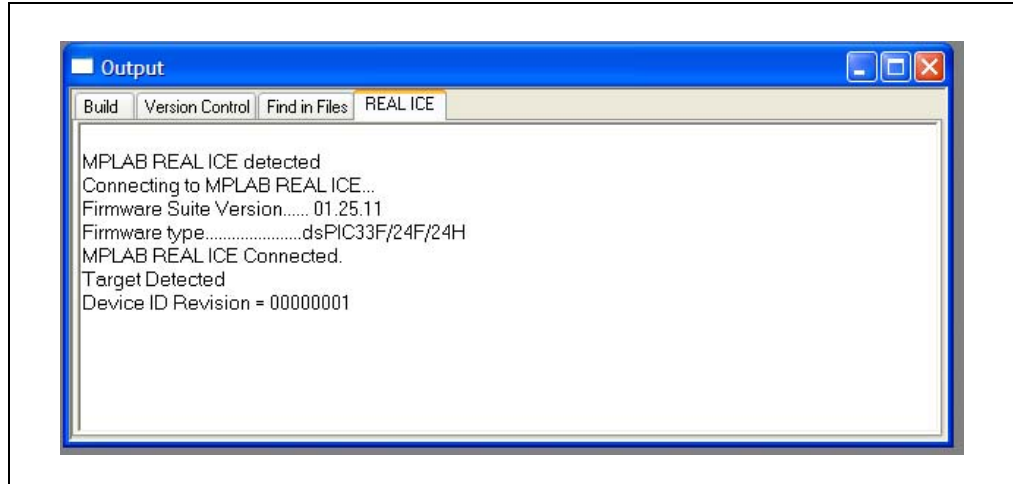

3.5.3 Program the Device

From the Debugger menu, select *Program* to program the part. The Output window (Figure 3-8) displays the program steps as they occur.

Observe the results of the programming. When the “Programming/Verify complete” message appears, the device is programmed and ready to run.

FIGURE 3-8: PROGRAMMING THE DEVICE

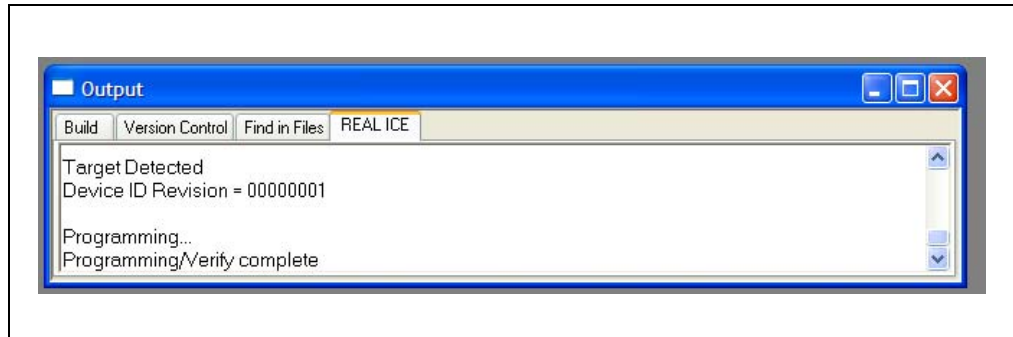

PIC24FJ256DA210 Development Board User's Guide

3.6 RUNNING THE CODE

The example application can either execute in real time (Run) or steps (Step Into, Step Over, and Animate.) Real-time execution occurs when you select Run in MPLAB IDE. Once the device code is halted, either by Halt or a breakpoint, you can step. The toolbar buttons (Figure 3-9) can be used for quick access to commonly used debug operations:

- Run
- Halt
- Animate
- Step Into
- Step Over
- Step Out
- Reset

FIGURE 3-9: DEBUGGING MENU OPTIONS

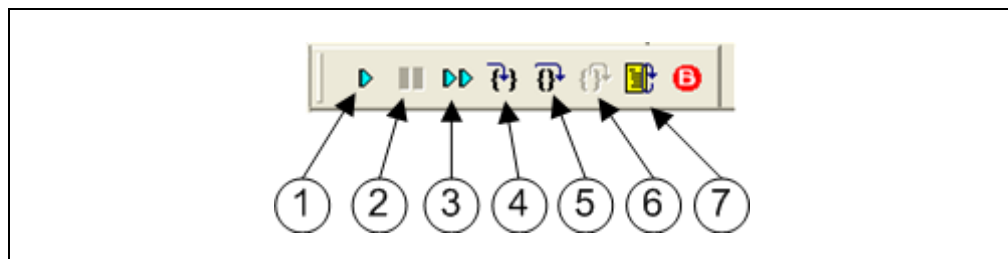

To see how these options function, do the following:

- Select *Debugger > Reset > Processor Reset* or click the Reset button to reset the program.
- Select *Debugger > Run*, or click the Run button. Observe how the application operates.
- Select *Debugger > Halt*, or click the Halt button to stop the program execution. A green solid arrow will mark the line of code in the File window where the program halted.
- Select *Debugger > Step Into*, or click the Step Into button, to step the program execution once. The green solid arrow will move down one line of code in the File window. Click the button several times to step through some code.
- Select *Debugger > Reset > Processor Reset*. Click the Reset button to reset the program again. The arrow will disappear, meaning the device is reset.

3.7 DEBUGGING THE CODE

Assuming that you have modified the code to implement your own application on the PIC24FJ256DA210, it is possible that it will not work after your first build and needs to be debugged. MPLAB IDE provides an editor and several debug features, such as breakpoints and Watch windows, to aid in application code debugging.

This section includes:

- Editing Application Code
- Using Breakpoints and Mouseovers
- Using Watch Windows

3.7.1 Editing Application Code

To view application code so it may be edited, do one of the following:

- Select *File > New* to create new code, or *File > Open* to search for and open an existing code file.
- Double click on a file in the Project window to open an existing code file. An example is shown in Figure 3-10.

For more information on using the editor to create and edit code, see the Help files for the MPLAB IDE Editor.

FIGURE 3-10: OPEN FILE FOR EDIT

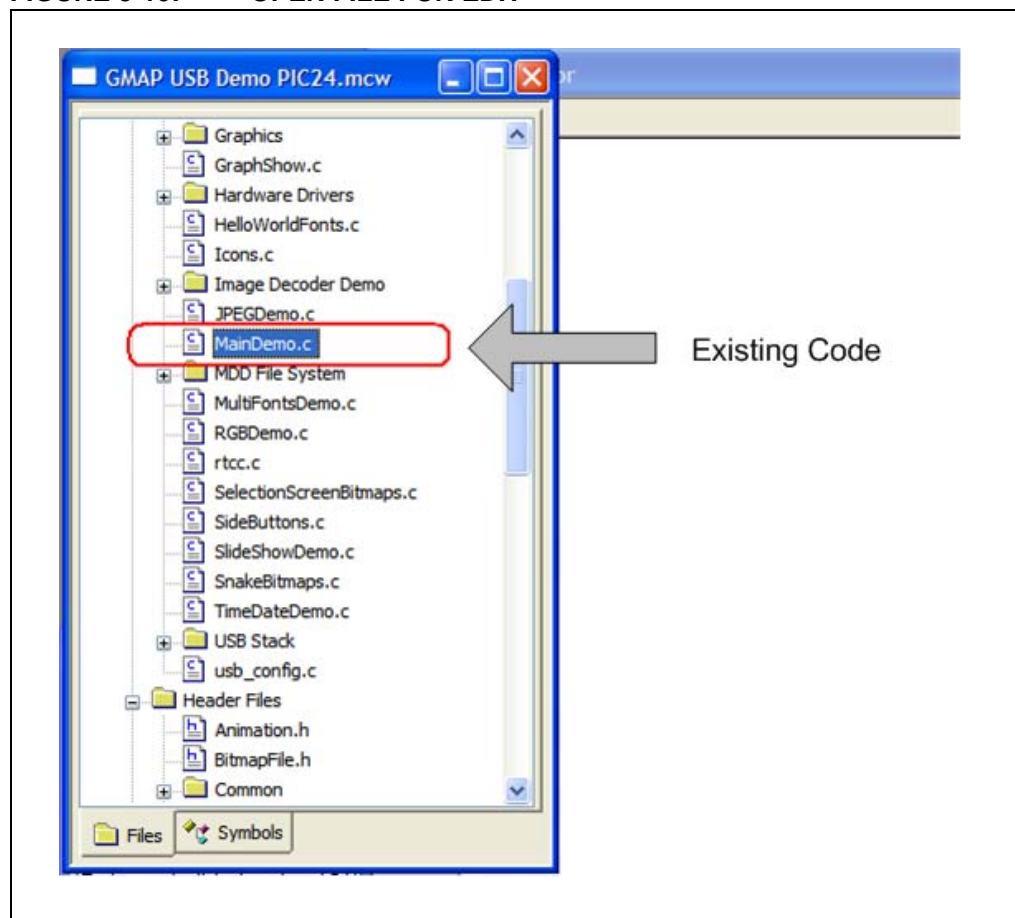

PIC24FJ256DA210 Development Board User's Guide

3.7.2 Using Breakpoints and Mouseovers

To set a breakpoint in code, use one of the following methods:

- **Double Click in Gutter:** Double click on the window gutter next to the line of code where you want the breakpoint. Double click again to remove the breakpoint.
- **Pop-up Menu:** Place the cursor over the line of the code where you want the breakpoint. Then, right click to pop up a menu and select "Set Breakpoint". Once a breakpoint is set, "Set Breakpoint" will become "Remove Breakpoint" and "Disable Breakpoint". Other options on the pop-up menu under Breakpoints are for deleting, enabling or disabling all breakpoints.
- **Breakpoint Dialog:** Open the Breakpoint dialog (*Debugger > Breakpoints*) to set, delete, enable or disable breakpoints. See MPLAB IDE Help for more information on this dialog.

A breakpoint set in code appears as red "stop sign" with a "B". Once code is halted, hovering over the variables pops up the current value of those variables (Figure 3-11). The mouseover feature must be set up. From the menu bar, select *Edit > Properties*; from the **Properties** dialog, select the **Tooltips** tab, and then click the **Enable Variable Mouseover Values** check box.

FIGURE 3-11: EXAMPLE BREAKPOINT

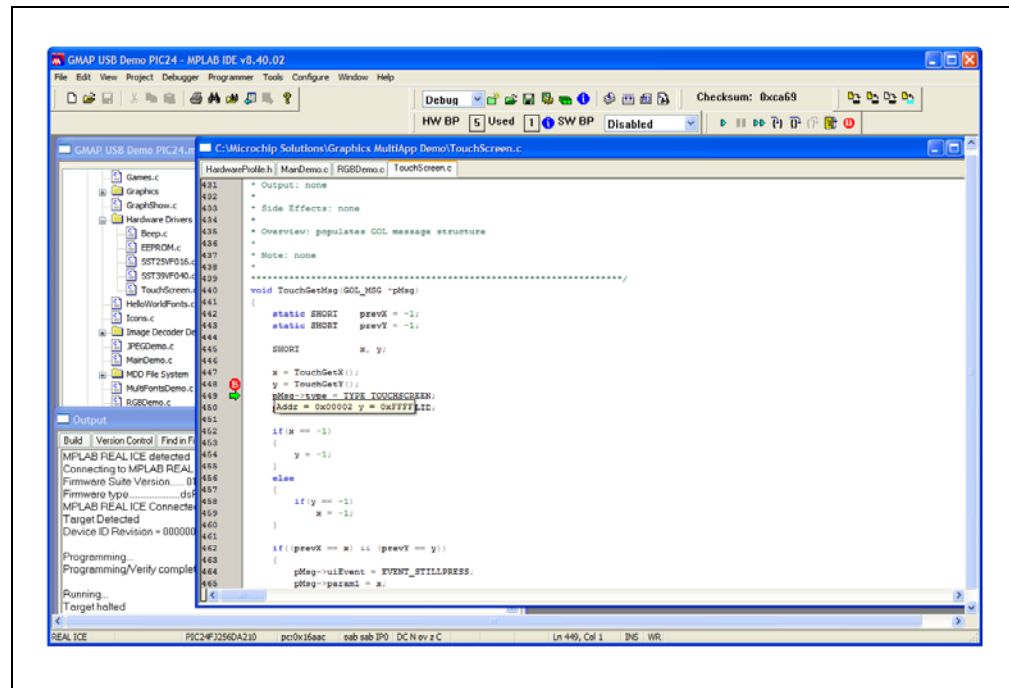

Programming and Debugging the Board

3.7.3 Using Watch Windows

To use a Watch window:

1. The Watch window is made visible on the desktop by selecting *View > Watch*. It contains four selectable watch views (via tabs) in which to view variables (SFRs, symbols and absolute address).
2. Select an SFR or symbol from the list and click the related **Add** button to add it to the Watch window, or click in the “Address” column and enter an absolute address.

A typical Watch window, populated with the SFRs and Symbols, is shown in Figure 3-12. For more on using the Watch windows, see the Help files for MPLAB IDE.

Note: When the optimization in the build is enabled, some of the variables may be optimized out and may not appear on the Watch window. In case this happens, you can either turn off the optimization or temporarily declare the variable as a volatile.

FIGURE 3-12: WATCH WINDOW EXAMPLE

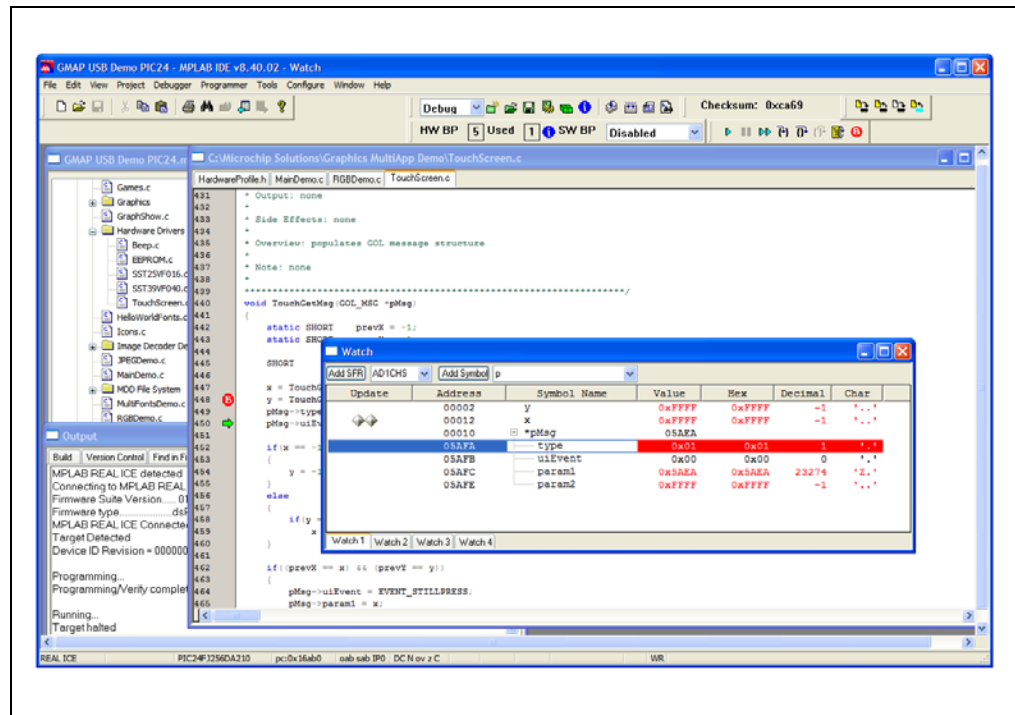

PIC24FJ256DA210 Development Board User's Guide

NOTES:

Chapter 4. Development Board Hardware

4.1 INTRODUCTION

This chapter provides a more detailed description of the hardware on the PIC24FJ256DA210 Development Board, and the procedures on configuring its many features. Topics covered include:

- Functional Overview
- General Hardware Features
- Setup and Configuration

4.2 FUNCTIONAL OVERVIEW

The development board is centered on the PIC24FJ256DA210 microcontroller which integrates in a single package a graphic controller, a CTMU for touch-sensing applications, and a wide range of other peripherals.

The microcontroller's Graphics module is capable of driving TFT, CSTN and MSTN displays in a number of sizes and color depths. Many display applications (up to 8 bpp in QVGA) can be run from the microcontroller's 96 KByte RAM buffer. For bigger displays or higher color resolution, the microcontroller can directly interface with external RAM devices for additional data storage. For non-volatile data storage, both serial and parallel Flash memory devices are provided.

The built-in USB functionality can be configured to operate in Device mode, as a stand-alone USB host, or as a USB On-The-Go (OTG) device. Host and OTG modes can be additionally configured for different types of bus sensing and external regulator support.

Push buttons, CTMU touch sensors and a potentiometer are provided for a variety of user-defined inputs. These share three common I/Os on the microcontroller, along with three LEDs, and are configured manually with jumpers.

A PICtail Plus edge connector is provided, allowing the development board to be used with different compatible PICtail Plus daughter board. An RS-232 port is provided for general purpose serial communications between the development board and a host PC; this serial port can also be re-configured to be available through the PICtail Plus connector.

Figure 4-1 shows the main components of the development board.

PIC24FJ256DA210 Development Board User's Guide

FIGURE 4-1: PIC24FJ256DA210 DEVELOPMENT BOARD BLOCK DIAGRAM

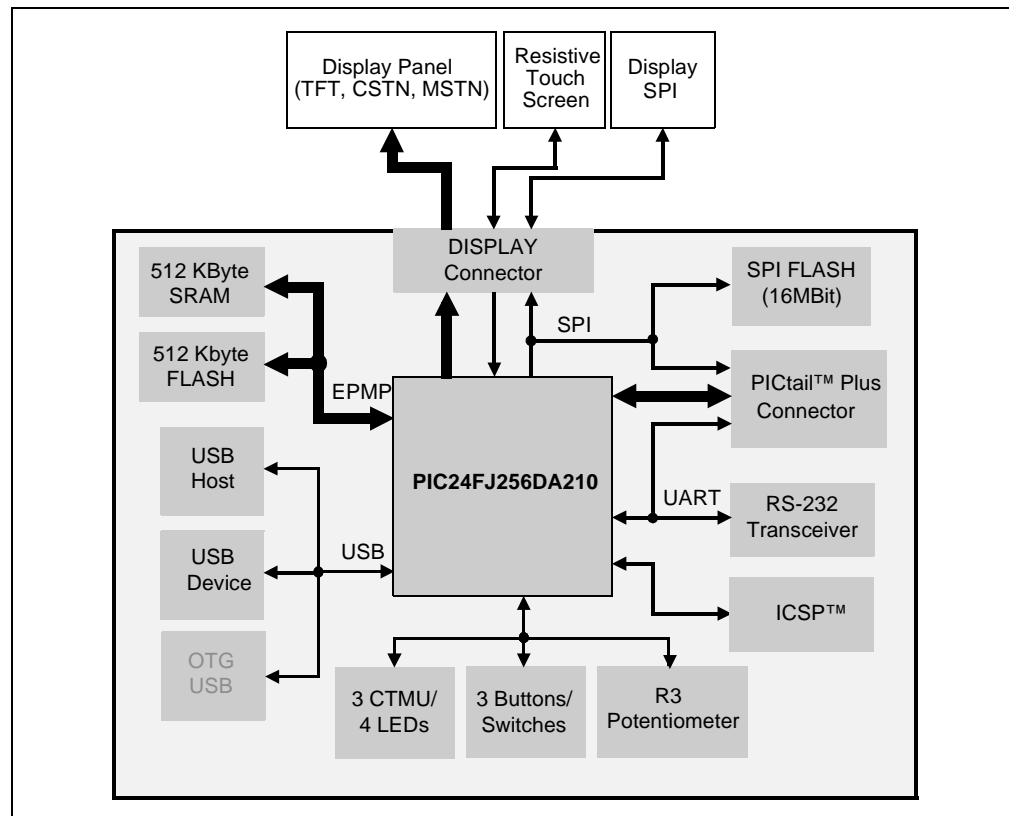

4.3 GENERAL HARDWARE FEATURES

4.3.1 PCB Layout

The PIC24FJ256DA210 Development Board uses several design strategies to provide a stable demonstration and development environment. Users should note these features and design tips when developing their own graphic applications.

The development board uses a four-layer PCB design; this allows high-frequency signals to be routed in a way to avoid crosstalk between data signals. It also gives additional noise protection due to improved grounding.

For additional noise protection, oscillator circuits and crystals are laid out with appropriate grounding and guard rings. The layout guidelines are described in **Section 2. “Guidelines for Getting Started with 16-Bit Microcontrollers”** of the device data sheet.

Each group of color signals (Red, Green and Blue) is routed together to reduce inter-color crosstalk. This means, for example, that Red signals are close together and do not mix with Green and/or Blue signals. Ideally, it is recommended to run a ground wire or trace between groups of color signals to reduce crosstalk. Also, the traces for color data should be as close to equal length as possible, and avoid the use of vias wherever possible.

4.3.2 Microcontroller

The development board is supplied with the PIC24FJ256DA210 microcontroller directly soldered to the board at U2. The device is installed with the notched corner (pin 1) oriented to the lower right. Vias are provided around the device, which allow access to all microcontroller signals; this is labelled on the board as U9. A riser may be installed here to facilitate connections to user added components in the prototyping area.

4.3.3 Oscillator Options

The PIC24FJ256DA210 Development Board is equipped with two separate oscillator circuits. The main oscillator uses an 8 MHz crystal (Y1) and functions as the controller's primary oscillator.

A second oscillator is implemented using a discrete oscillator circuit with a 32.768 kHz (watch type) crystal (Y2). This is connected to the microcontroller's SCLKI pin, providing an external clock source for the secondary oscillator option used to clock the RTCC and Timer1 modules. A discrete oscillator is used in this application to free up an additional pin for general I/O use. To use this clock source, the microcontroller must be configured to use External Clock mode for the secondary oscillator. For additional information on secondary oscillator configuration, refer to the "*PIC24FJ256DA210 Family Data Sheet*" (DS39969).

4.3.4 Power Supply

The PIC24FJ256DA210 Development Board supports two power options.

In the first, an unregulated DC supply of 9V to 15V is supplied to J1. (A power supply is not provided with the development board, unless the kit was purchased. If one is required, Microchip Part number AC162039 is recommended). The 5V and 3.3V regulators (Q1 and Q2, respectively) provide stable power to the board, as well as compatible display daughter boards. Regulated 3.3V voltage is derived from the 5V regulated voltage.

Optionally, an external, regulated DC power supply can be used to provide power to the board. Two separate voltages are required: +5V (to TP3, the red terminal near the upper left corner, adjacent to J9) and +3.3V (to TP4, the yellow terminal near the upper right corner, adjacent to the prototype area).

The on-board voltage regulators can deliver a total combined current of 800 mA. If a larger display with a current rating higher than 800 mA (combined board and display rating) is to be used, the display board must be independently powered. In these cases, power to the display cannot be provided through display connector V1. Only common ground between the development board and the larger display should be connected through V1.

A green power-on LED (D6) indicates when power is applied to the board from either source. The power-on LED indicates the presence of +3.3V.

4.3.5 Programming and Debugging Interface

The PIC24FJ256DA210 Development Board can be programmed using either the (PICkit) connector (J9) or the 5-wire, RJ-11 (ICD) connector (J10). Only one interface may be used at any given time.

Use J9 to connect a PICkit 3 programmer, or other similar programmer/debugger devices, to program the development board. Use J10 to program the board using the MPLAB ICD 3 debugger or MPLAB REAL ICE in-circuit emulator.

4.3.6 Reset Switch (S4)

Switch S4 is connected to the $\overline{\text{MCLR}}$ line of the microcontroller. When pressed, it pulls the $\overline{\text{MCLR}}$ pin low, resetting the microcontroller (and any application the microcontroller is running). The same reset signal is also connected to the Reset signals of the PICkit and ICD connectors. However, any applications being run on PICtail daughter cards installed in the PICtail Plus port will not be automatically reset. In these cases, the user must provide an alternate hardware signal to the daughter board.

PIC24FJ256DA210 Development Board User's Guide

4.4 SETUP AND CONFIGURATION

The PIC24FJ256DA210 Development Board has been designed with a wide range of hardware options. These allow the user to evaluate the entire range of the microcontroller's features, include user-defined inputs, explore the range of graphics options, and incorporate USB connectivity options.

To maintain flexibility, many of the board's hardware options are configured using standard jumpers. In a few cases, modifying the board at several locations (by the addition or removal of resistors) may also be required. Details of the configuration options and how to select them are provided in the following sections. A list of the development board's configuration jumpers is provided in Table 4-1; their corresponding locations are shown in Figure 4-2.

TABLE 4-1: JUMPER SETTINGS AND CONFIGURATION OPTIONS

Key	Jumper	Function
1	JP5	Enables USB OTG
2	JP6	Enables USB Embedded Host mode
3	JP7	Enables USB Device mode
4	JP8	Sets Byte Enable mode for on-board parallel memory
5	JP9	Configures RA1 and RC4 for resistive touch screen (Y-, X+) or SPI-based touch controller (TC_CS, PEN_INT)
6	JP10	
7	JP11	Selects RA7 for LED D4 or PMA17
8	JP12	Configures RD0 for LCD backlight control or serial RX
9	JP13	Configures RG8 as S1 input or CTMU1 input/LED output
10	JP14	Configures RE9 as S2 input or CTMU2 input/LED output
11	JP15	Configures RB5 as S3 input, R3 input, or CTMU3 input/LED output
12	JP16	Selects serial TX channel connection
13	JP17	Selects serial RX channel connection
14	JP23	Selects serial (default) or parallel Flash memory

FIGURE 4-2: LOCATION OF DEVELOPMENT BOARD JUMPERS

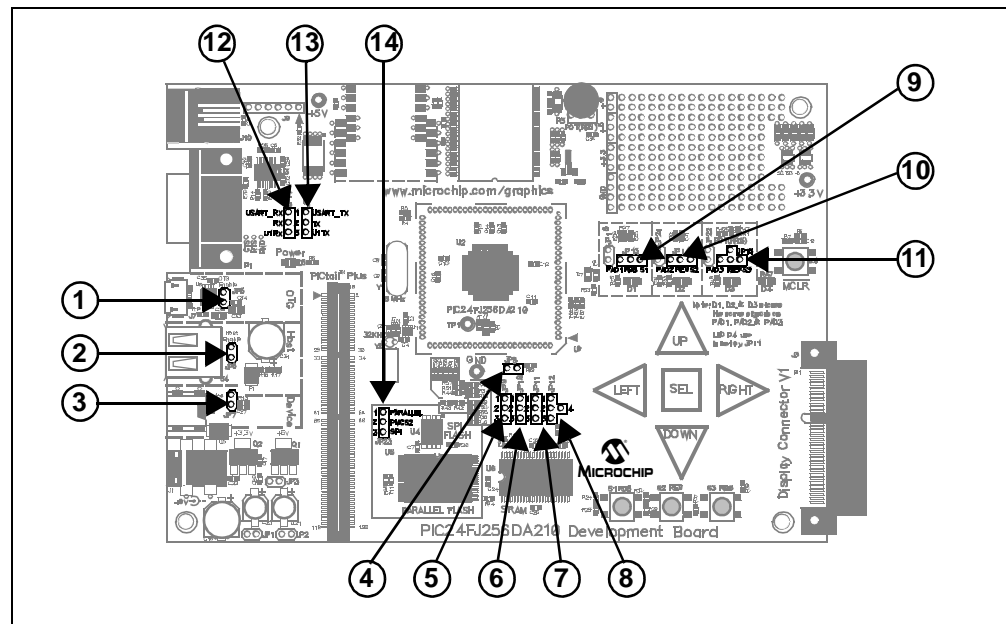

Development Board Hardware

Due to pin constraints, some features of the development board overlap more than others. In these cases, configuring the board for one major functionality means limiting or disabling another. Table 4-2 shows the major areas of overlap. Additional details are provided in the following sections.

TABLE 4-2: SUMMARY OF BOARD CONFIGURATIONS VS. AVAILABILITY OF SPECIFIC FEATURES

Individual Feature	Board Configuration Options			
	No CTMU	CTMU	USB OTG	PICtail™ Plus Options
Flash and SRAM access modes	Byte and Word	Byte and Word	Byte and Word	Word only ⁽¹⁾
Parallel Flash/SPI Flash Memory	512 Kbytes/2 Mbit	512 Kbytes/2 Mbit	512 Kbytes/2 Mbit	256 Kbytes/N.A.
SRAM	512 Kbytes	512 Kbytes	512 Kbytes	256 Kbytes
Resistive Touchscreen OR Touch SPI channel	Y	Y	Y	Y
Potentiometer	Y	N	N	Y
Touch pads (CTMU)	N	Y ⁽²⁾	N	N
User-defined Buttons	Y	N	N	Y ⁽²⁾
User-defined LEDs	N	Y ⁽³⁾	N	1
UART Channels	1	1	1	1
USB Modes	Host or Device	Host or Device	OTG only	Host or Device
PICtail Plus Expansion	N	Y ⁽³⁾	N	Y

Note 1: The only display mode available in this configuration is 16 bpp.

2: CTMU channels and push buttons are available with certain PICtail™ Daughter Boards only. The number of inputs available depends on the daughter board and the application. See **Section 4.4.6 “PICtail™ Plus Card Modular Expansion Connector”** for additional information.

3: LED outputs are shared with CTMU input channels.

4.4.1 User-Defined Inputs and LEDs

The PIC24FJ256DA210 Development Board implements a variety of user-defined inputs: push button switches, capacitance-sensing touch pads, a potentiometer, and four LEDs. The development board multiplexes the switches, touch sensors, potentiometer and three of the LEDs through three I/O pins (RB5, RE9 and RG8). For each of these pins, only one input mode can be chosen at any given time. The fourth LED (D4) shares a pin with an address line for the external memory devices.

Note that the implementation of shared inputs and outputs used in the development board is not a recommended design practice. In this case, it is implemented in consideration of I/O pin constraints. Using separate pins for different input and output features is always recommended.

If the CTMU touch sensors are enabled, the LEDs can be used simultaneously. However, care must be taken in the application to switch the I/O pins alternately as analog input and digital output as required. Please refer to the “*PIC24FJ256DA210 Family Data Sheet*” (DS39969) for details on configuring the I/O ports.

The user-defined features are configured using jumpers J13, J14 and J15. In some cases, modifications to accompanying resistors are also required. The locations of the components are shown in Figure 4-3. A summary of the jumper settings is provided in Table 4-3.

PIC24FJ256DA210 Development Board User's Guide

FIGURE 4-3: CONFIGURATION OF USER-DEFINED FEATURES

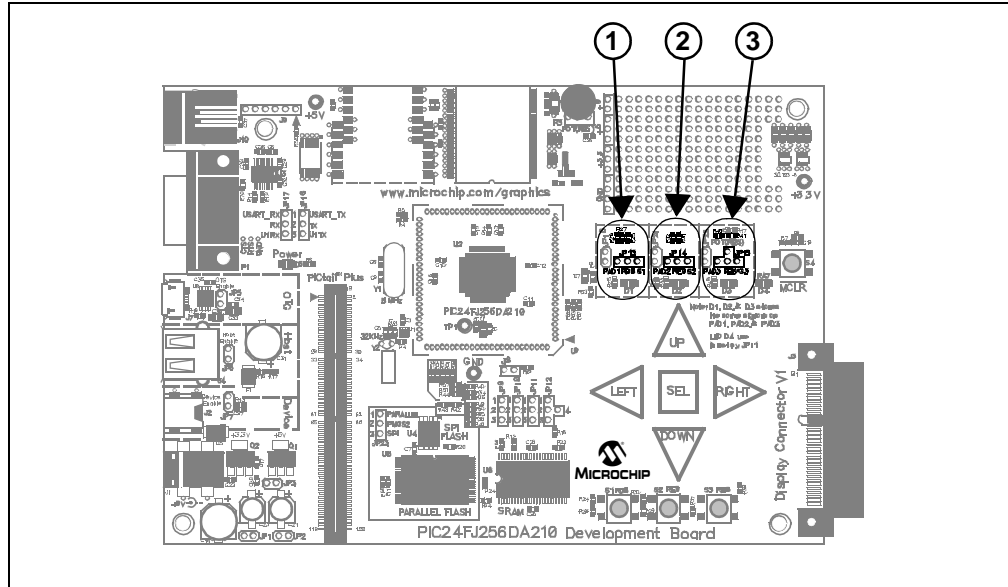

TABLE 4-3: JUMPER SETTINGS FOR RB5, RE9 AND RG8 INPUTS

Jumper	Configuration	Jumper Setting
JP13	RG8 is push button S1 input (default)	RG8-S1
	RG8 is CTMU Pad 1 input and LED D1 output	PAD1-RG8
JP14	RE9 is push button S2 input (default)	RE9-S2
	RE9 is CTMU Pad 2 input and LED D2 output	PAD2-RE9
JP15	RB5 is push button S3 input	RB5-S3
	RB5 is CTMU Pad 3 input and LED D3 output	PAD3-RB5
	RB5 is potentiometer (R3) input (default)	RB5-POT

4.4.1.1 USER-DEFINED PUSH BUTTONS (S1, S2 AND S3)

The development board comes with three general purpose switches, S1, S2 and S3, for user inputs. The push button switches are normally pulled up to VDD when unpressed, and pulled to ground when pressed.

To enable the switches:

1. To enable switch S1 (Figure 4-3, callout 1):
 - a) Set jumper JP13 to bridge RG8-S1 (default).
 - b) Populate resistor R25 with a 0Ω resistor (default)
 - c) If installed, remove resistors R26 and R27 (not populated by default)
2. To enable switch S2 (Figure 4-3, callout 2):
 - a) Set jumper JP14 to bridge RE9-S2 (default)
 - b) Populate resistor R31 with a 0Ω resistor (default)
 - c) If installed, remove resistor R32 (not populated by default)
3. To enable switch S3 (Figure 4-3, callout 3):
 - a) Set jumper JP15 to bridge RB5-S3
 - b) Populate resistor R41 with a 0Ω resistor (default)
 - c) If installed, remove resistor R45 (not populated by default)

4.4.1.2 CTMU TOUCH SENSE INPUTS

The development board is equipped with five touch sensor inputs. These are multiplexed between three CTMU (Charge Time Measurement Unit) analog channels, as shown in Table 4-4. The areas within the white border of each pad is the touch-sensitive areas. Note that all three CTMU inputs must be enabled to use the entire pad.

TABLE 4-4: CTMU TOUCH PAD COMBINATIONS

Touch Pad	PAD1 (RG8)	PAD2 (RE9)	PAD3 (RB5)
LEFT	X	X	
RIGHT	X		X
UP		X	
DOWN			X
SEL		X	X

To enable the CTMU Touch Pads:

1. To enable PAD1 (Figure 4-3, callout 1):
 - a) Set jumper JP13 to position PAD1–RG8
 - b) If installed, remove resistors R26 and R27
 - c) Populate resistor R25 with a 0Ω resistor (default)
2. To enable PAD2 (Figure 4-3, callout 2):
 - a) Set jumper JP14 to position PAD2–RE9
 - b) If installed, remove resistor R32
 - c) Populate resistor R31 with a 0Ω resistor (default)
3. To enable PAD3 (Figure 4-3, callout 3):
 - a) Set jumper JP15 to position PAD3–RB5
 - b) If installed, remove resistor R45
 - c) Populate resistor R41 with a 0Ω resistor (default)

Note: CTMU signals are connected to PIC24FJ256DA210 analog pins. Make sure that the pins are set to analog pins using their corresponding ANSx control bits. Refer to the “PIC24FJ256DA210 Family Data Sheet (DS39969)” for details.

4.4.1.3 ANALOG INPUT (POTENTIOMETER)

Pin RB5 can also be configured to read potentiometer R3. This selection is enabled by setting JP15 to position RB5–POT. No other changes are required.

4.4.1.4 LED OUTPUTS

There are four user-defined LEDs on the development board.

LEDs D1, D2 and D3 (red) are multiplexed with the CTMU pads. They are individually enabled when their corresponding CTMU pads are enabled, as described in **Section 4.4.1.2 “CTMU Touch Sense Inputs”**.

LED D4 (red) is multiplexed with address line 17 of the parallel RAM and Flash memories. To use this LED, jumper JP11 must be set to position 1-2. Refer to **Section 4.4.5 “On-Board External Memory”** for more information.

PIC24FJ256DA210 Development Board User's Guide

4.4.2 USB Connectivity

The PIC24FJ256DA210 Development Board supports three distinct full-speed USB modes: Host mode (default), Device mode, and USB On-The-Go (OTG) mode. Although the particular operating mode of the microcontroller is determined by the application and device configuration, the development board hardware also needs to be configured to suit the mode as well. These are selected by the USB mode jumpers (Figure 4-4, callout 1). Additional current sense options for Host and OTG modes are configured with setting I/O jumpers and modifying certain on-board resistors (callouts 2 and 3).

Note: Only one USB mode may be enabled in hardware at any time.

FIGURE 4-4: CONFIGURING USB MODES

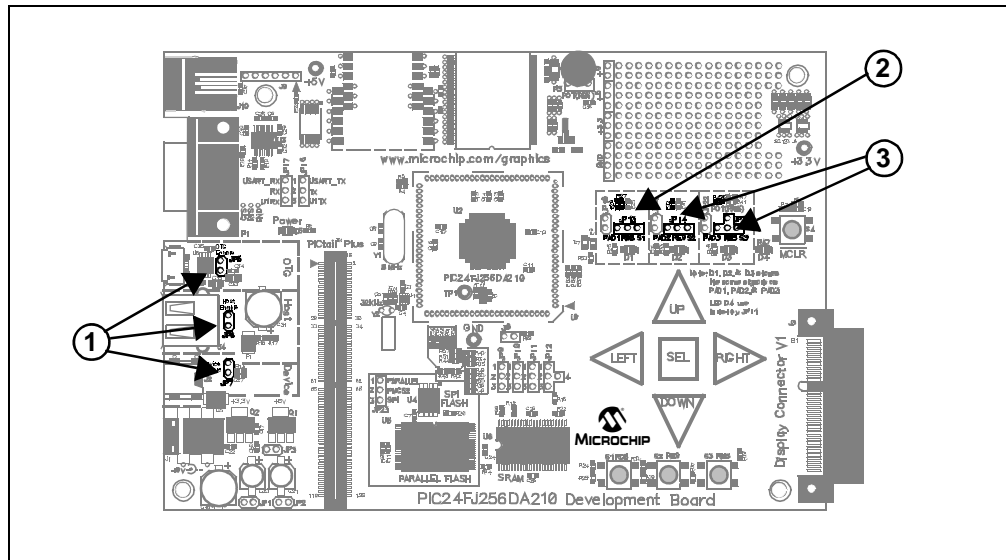

4.4.2.1 USB HOST MODE (DEFAULT)

To enable the USB Host Mode:

1. Install jumper JP6.
2. Remove jumpers JP5 and JP7.
3. If the application requires detection of drawn current by the device on the USB line, enable the detection of an analog OVERCURRENT signal at pin AN19/RG8 of the microcontroller as follows (Figure 4-4, callout 2):
 - a) Open jumper JP13 (disconnects CTMU_PAD1, LED D1 and Switch S1).
 - b) Populate R26 with a 0 Ω resistor.
 - c) If installed, remove resistor R27. (R27 may have been installed if the USB OTG mode was previously enabled. See **Section 4.4.3.1 “UART and USB OTG Mode (TX Remapping)”** for more information.)

In Host mode, use J4 (Type A Female USB connector) to connect to an external USB device.

4.4.2.2 USB DEVICE MODE

To enable USB Device mode:

1. Install jumper JP7.
2. Remove jumpers JP5 and JP6.

In this mode, use J2 (Type Mini B Female USB connector) to connect to an external USB Host.

4.4.2.3 USB ON-THE-GO (OTG) MODE

To enable the USB OTG mode:

1. Install jumper J5.
2. Remove jumpers J6 and J7.
3. To detect the status of the regulated output voltage of the charge pump, connect the charge pump PGOOD signal to the microcontroller (Figure 4-4, callout 3):
 - a) Remove jumper JP14 (disconnects CTMU_PAD2, LED D2 and switch S2).
 - b) Populate resistor R32 with a 0 Ω resistor (connects PGOOD signal to pin AN21/RE9).
4. To have software control of the charge pump, connect the $\overline{\text{SHDN}}$ signal to the microcontroller (Figure 4-4, callout 3):
 - a) Remove jumper JP15 (disconnects the potentiometer, switch S3, CTMU_PAD3 and LED D3).
 - b) Populate resistor R45 with a 0 Ω resistor.

In USB OTG mode, use J7 (Type Micro AB Female USB connector) to connect with external USB OTG devices.

Note: Enabling USB OTG mode may require the remapping of the UART's TX signal. See **Section 4.4.3.1 "UART and USB OTG Mode (TX Remapping)"** for more information.

4.4.3 UART (RS-232)

The development board provides one UART, with its RX and TX signals appearing on pins RD0 and RF3 of the PIC24FJ256DA210, respectively. The signals can be configured to appear at one of two places:

- The RS-232 external serial port (default).
- The PICtail Plus connector, as signals U1RX (pin 2) and U1TX (pin 4).

An RS-232 level shifter (U3) has been provided with all necessary hardware to support the external serial port. The DB-9F serial connector (P1) is wired to support hardware flow control; however, the flow control signals are not connected to the microcontroller. The port is configured as a Data Communication Equipment (DCE) device.

Note: The TX and RX signals are mapped to the microcontroller pins using the Peripheral Pin Select (PPS) feature. When developing applications, make sure that the pins are remapped properly to use the UART Receive and UART Transmit signals. Refer to **Section 10.4 "Peripheral Pin Select"** of the PIC24FJ256DA210 data sheet for a detailed discussion of PPS.

The UART's availability is configured by jumpers JP16 and JP17. Their location is shown in Figure 4-5.

To access the UART through the RS-232 serial port:

1. Set jumper J16 to position 1-2 (USART_TX – TX) (default).
2. Set jumper J17 to position 1-2 (USART_RX – RX) (default).

In this configuration, a host PC running the appropriate application can communicate with the development board using the serial channel. Use a standard ("straight-through") serial cable connected to P1.

To access the UART through the PICtail Plus expansion port:

1. Set jumper J16 to position 2-3 (U1TX – TX).
2. Set jumper J17 to position 2-3 (U1RX – RX).

In this configuration, the U1RX and U1TX signals appear at pins 2 and 4 of the PICtail Plus connector, respectively.

PIC24FJ256DA210 Development Board User's Guide

FIGURE 4-5: UART CONFIGURATION

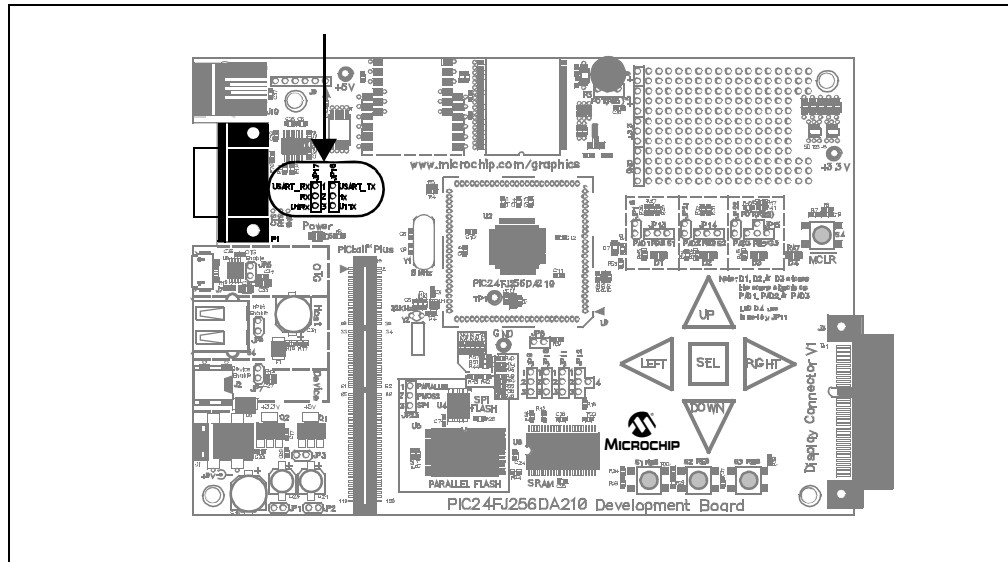

4.4.3.1 UART AND USB OTG MODE (TX REMAPPING)

Normally, the UART TX signal appears on pin RF3, along with the USBID signal. When USB OTG mode is enabled, USBID takes priority over the TX signal. If the UART is also needed, this requires the TX signal to be remapped to another pin. The development board allows for RG8, normally used for S1/PAD1/LED1, to function as the TX signal in these cases. In addition to remapping the pin in software using PPS, resistor R4, R5, R26 and R27 will also need to be changed (Figure 4-6).

To remap the TX signal with USB OTG enabled:

1. If populated, remove resistor R4 (callout 1). Alternatively, remove jumper JP13 (callout 2). (Both disconnect the TX signal from pin RF3.)
2. Populate resistor R5 (callout 1) with a 0Ω resistor (connects USBID signal to pin RF3).
3. Populate resistor R27 with a 0Ω resistor (callout 2) (connects TX signal to pin RG8).
4. If populated, remove resistor R26 (callout 2) (disconnects Overcurrent Sense signal).

FIGURE 4-6: REMAPPING THE UART TX SIGNAL

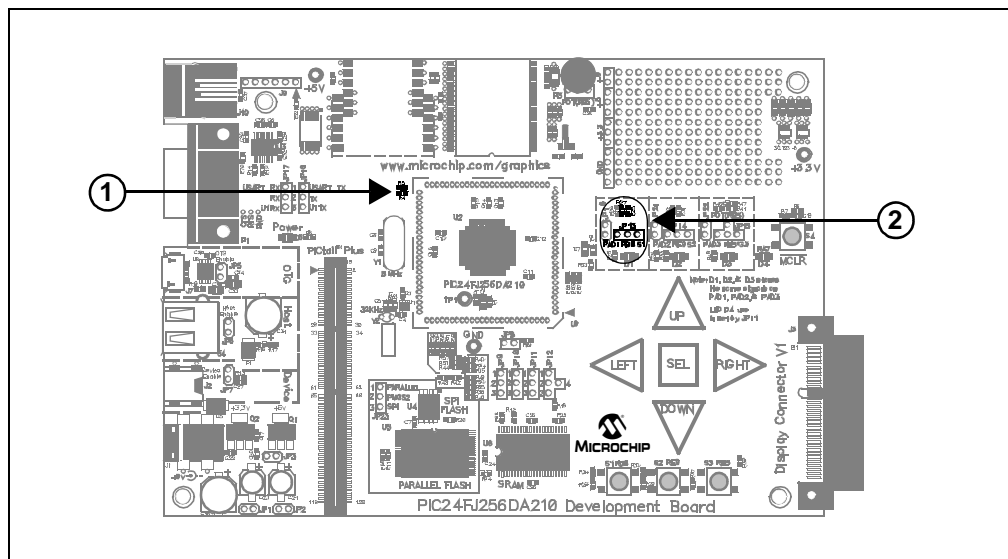

4.4.3.2 UART AND DISPLAY BACKLIGHT (RX SIGNAL)

The UART's RX signal is mapped to only one pin (RD0) of the microcontroller. This pin is also used by the development board to optionally control the backlight for the display daughter board; all functions are multiplexed through the same jumper, JP12. If either of the backlight control options is selected, the UART becomes unavailable to the external RS-232 port.

4.4.4 Graphics Port

The PIC24FJ256DA210 Development Board can support TFT, MSTN and CSTN displays. Displays of 4, 8 and 16-bit data widths are supported. The 64-pin display Connector V1 (J3) (on the right hand side bottom corner of the board) is provided for connection of Microchip display boards.

4.4.4.1 TFT AND STN INTERFACES

When developing applications using TFT displays and the Graphics Display Prototype Board, the 16-bit display bus can be used to send 16-bit RGB data (5-6-5 bits respectively) to a standard 24-bit (8-8-8) or 18-bit (6-6-6) RGB display. To do this, color data from the microcontroller is mapped to the Most Significant bits (MSBs) of the display. The Least Significant bit lines of the display (3-2-3 for 24-bit displays, 1-0-1 for 18-bit) are then tied to the MSb. This technique allows full brightness whenever the MSb is '1', and full blackness when the MSb is '0'. The controller-to-display data mapping is detailed in Table 4-5.

TABLE 4-5: RGB INTERFACE MAPPING FOR TFT DISPLAYS

Graphics Data Pins (GDx)	18-Bit RGB Display (6-6-6)	24-Bit RGB Display (8-8-8)
RED		
GD<15:11>	Red<5:1>	Red<7:3>
GD<15>	Red<0>	Red<2:0>
GREEN		
GD<10:5>	Green<5:0>	Green<7:2>
GD<10>	Green<5>	Green<1:0>
BLUE		
GD<4:0>	Blue<5:1>	Blue<7:3>
GD<4>	Blue<0>	Blue<2:0>

4.4.4.2 STN INTERFACES

The development board can directly interface with STN displays (both CSTN and MSTN) of 4, 8 or 16-bit data width. The mapping of graphics data to the display data input is described in Table 4-6. Configuration of the different data widths is done by the graphics controller module through the register interface. Refer to the "PIC24FJ256DA210 Family Data Sheet" (DS39969) for more information.

TABLE 4-6: STN INTERFACE MAPPING

Graphics Data Pins (GDx)	4-bit	8-bit	16-bit
GD<3:0>	M<3:0>	M<3:0>	M<3:0>
GD<7:4>	Unused	M<7:4>	M<7:4>
GD<15:8>	Unused	Unused	M<15:8>

PIC24FJ256DA210 Development Board User's Guide

4.4.4.3 RESISTIVE TOUCH SCREEN INTERFACE

The development board supports display panels with a built-in 4-wire resistive touch screen. The resistive touch screen interface (X-, Y-, X+ and Y+) is used to directly connect to the touch screen signals. X+ and Y+ are both analog and digital signals, and are connected to I/O ports that can function both as analog inputs and digital outputs. X- and Y- are digital output signals only, and are connected to digital I/O ports. The X+ and Y- signals are multiplexed with the SPI based touch screen controller.

When using the 4-wire resistive touch screen interface, jumpers JP9 and JP10 must be set to their default positions, bridging pins 1 and 2 (Figure 4-7, callout 1).

4.4.4.4 SPI TOUCH CONTROLLER INTERFACE

Two SPI channels (two Chip Select lines) are provided in Display Connector V1 to support display panels equipped with the following:

- **SPI-Based Timing Controller:** Some displays requires programming of an on-board Timing Controller (TCON) to initialize the settings of the display before it is used. The TCON is used to synchronize the display glass timing with the display controller signal timing. This option is provided on the pins A27 (SPI_SCK), A28 (SPI_MISO), B27 (DISP_SPI_CS) and B28 (SPI_MOSI) of display connector V1.
- **SPI-Based Touch Controller:** In some cases, an SPI-based touch module is used with the display. Every time a touch is detected, it sends an interrupt to the host controller to inform the host that there is a fresh touch input and the information must be forwarded from the touch module to the host controller through SPI communications. The development board shares two of the pins of the 4-wire resistive touch screen with the interrupt and chip select line of the SPI based touch controller. The sharing is done this way since in any system, only one of the two types of user interface will be used.

The SPI-based touch control features are configured by jumpers JP9 and JP10 (Figure 4-7, callout 1). To enable the use of an SPI-based touch controller, set jumpers JP9 and JP10 to bridge positions 2-3.

Note: As of this writing, none of the Microchip display boards support SPI-based touch controllers.

FIGURE 4-7: TOUCH CONTROLLER AND BACKLIGHT CONFIGURATION

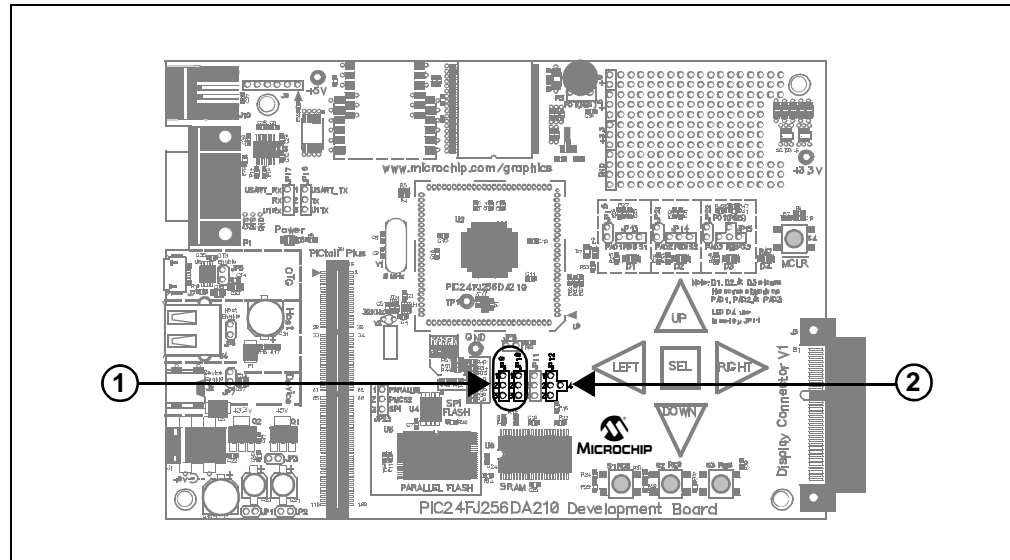

4.4.4.5 BACKLIGHT CONTROL

Depending on the display glass being used, backlight control is provided as an ON/OFF signal, or as a PWM pulse train for a continuous range of brightness. Jumper JP12 (Figure 4-7, callout 2) selects which signal is enabled on display connector V1. By default, backlight control is disconnected (position 2-4).

- To enable BKLT_EN (ON/OFF), set JP12 to bridge 2-3.
- To enable BKLT_PWM (PWM controlled contrast), set JP12 to bridge 1-2.

Note: If either of the backlight control modes is selected, access to the UART will be disabled. See **Section 4.4.3.2 “UART and Display Backlight (RX Signal)”** for more information.

4.4.5 On-Board External Memory

The PIC24FJ256DA210 can be used to create a graphics solution without any external memory resources. However, in cases where the application requires a higher color depth (8 bits per pixel or more), or larger storage for images and data, external SRAM and Flash memory devices are provided on the development board.

Both SRAM and parallel Flash memory can be enabled at the same time. The Enhanced Parallel Master Port module (EPMP) accesses memory on both devices with the same data and address lines. PMCS1 is used as the Chip Select signal for the SRAM, and PMCS2 is used for the parallel Flash. Note, however, that configuring a memory addressing size option for one device selects the same size for the other.

If all 19 address lines of the EPMP are not required, PMA17 and PMA18 can be configured for other purposes. PMA17 can be used to control LED D4, while PMA18 can be reconfigured to function as an I/O on the PICtail Plus Expansion port.

For more information on using the EPMP, refer to “*Enhanced Parallel Master Port (EPMP)*” (DS39730) for more information.

4.4.5.1 EXTERNAL SRAM

The PIC24FJ256DA210 Development Board is provided with 512 Kbyte of external SRAM, populating U6. By default, only 256 out of the 512 KByte is enabled; this allows PMA17 to control LED D4 in the default board default configuration. If required, the SRAM may be upgraded to 1 MByte by replacing U6 with a different device. The SRAM interfaces with the microcontroller through the EPMP interface. Use of external SRAM is optional if internal 24/96 Kbyte RAM of PIC24FJ256DA210 cannot accommodate the required frame buffer size for a specific color depth and resolution combination.

SRAM access time is an important aspect of the interface to the EPMP port. In most QVGA based applications, the use of a 55 ns access time is enough to meet the refresh requirements of the display. The use of a 10 ns access time SRAM on the board is due to the fact that VGA resolution display, which requires more bandwidth, can also be driven by the development board.

The SRAM can be configured for one of three memory address ranges, shown in Table 4-7.

TABLE 4-7: SRAM MEMORY OPTIONS

Size	JP11	R63	Active EPMP Address Lines	Recommended Part #s
256 Kbyte (default)	Open	Open	PMA<16:0>	IS61LV25616AL-10TL IDT71V416S AS7C34098A
512 Kbyte	Bridged	Open	PMA<17:0>	
1 Mbyte	Bridged	0Ω	PMA<18:0>	IS61WV51216BLL-10TLI

PIC24FJ256DA210 Development Board User's Guide

The SRAM options are configured by two jumpers, JP8 and JP11, and resistors R62 and R63. Their locations on the board are shown in Figure 4-8.

FIGURE 4-8: SRAM CONFIGURATION

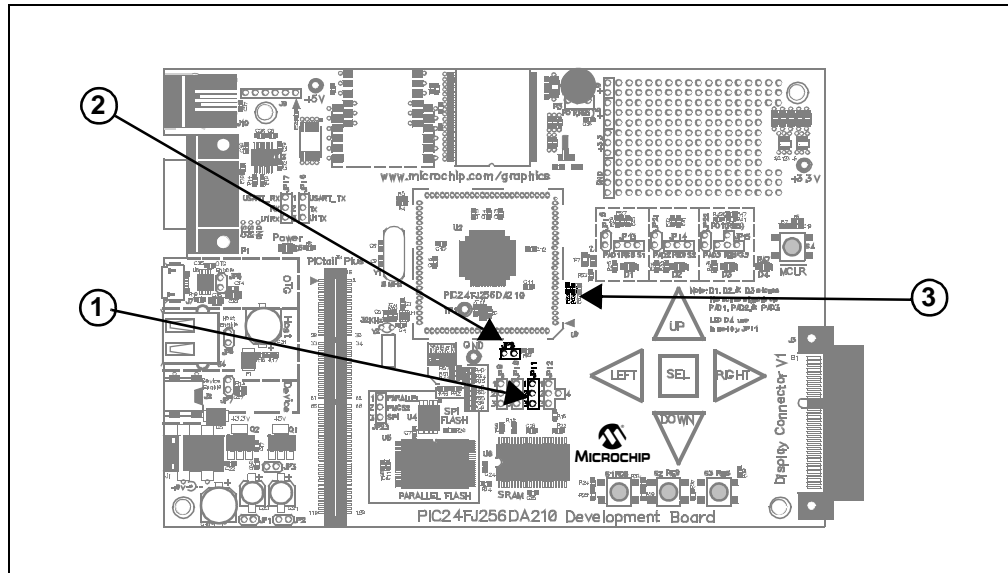

To configure for the 256 KByte address range (default):

1. Set JP11 (callout 2) to position 1-2 to connect PMA17 to LED D4 only, and use that microcontroller pin to control the LED.
Alternatively, remove jumper JP11 (disconnects PMA17 signal entirely).
2. If installed, remove resistor R63 (callout 2) (disconnects PMA18 signal).
3. For TFT displays using 8 bpp color depth, install jumper JP8 to enable Byte access addressing.

To enable the 512 KByte range of external SRAM:

1. Set jumper JP11 (callout 1) to position 2-3 (connects PMA17 signal to the SRAM).
2. If installed, remove resistor R63 (callout 3) to disconnect PMA18 signal to the address 18 of the RAM.
3. Install jumper JP8 (callout 2) to enable Byte access in the external RAM. Byte access is needed when the color depth used for TFT displays is 8 bpp.

To enable the full 1 MByte address range for the SRAM (assuming U6 is populated with a 1 Mbyte device):

1. Set jumper JP11 (callout 1) to position 2-3 (connects PMA17 signal to the SRAM).
2. Populate resistor R63 (callout 3) with a 0Ω resistor (connects PMA18 signal to the SRAM)
3. If installed, remove resistor R62 (callout 3) (disconnects PICtail Plus connector from PMA18).
4. For TFT displays using 8 bpp color depth, install jumper JP8 (callout 2) to enable Byte access addressing.

4.4.5.2 EXTERNAL FLASH MEMORY

The PIC24FJ256DA210 Development Board has two external Flash memory devices. Selection is controlled by jumper JP23. Only one can be enabled at any given time:

- 512 Kbyte Parallel Flash (SST39LF400A), connected to the EPMP port.
- 16 Mbits (2 Mbyte) SPI Serial Flash (SST25VF016B).

Flash memory configuration uses the same jumpers and resistors as SRAM configuration (Figure 4-9). An additional jumper, JP23 (callout 1), selects between the serial and parallel devices.

FIGURE 4-9: FLASH MEMORY CONFIGURATION

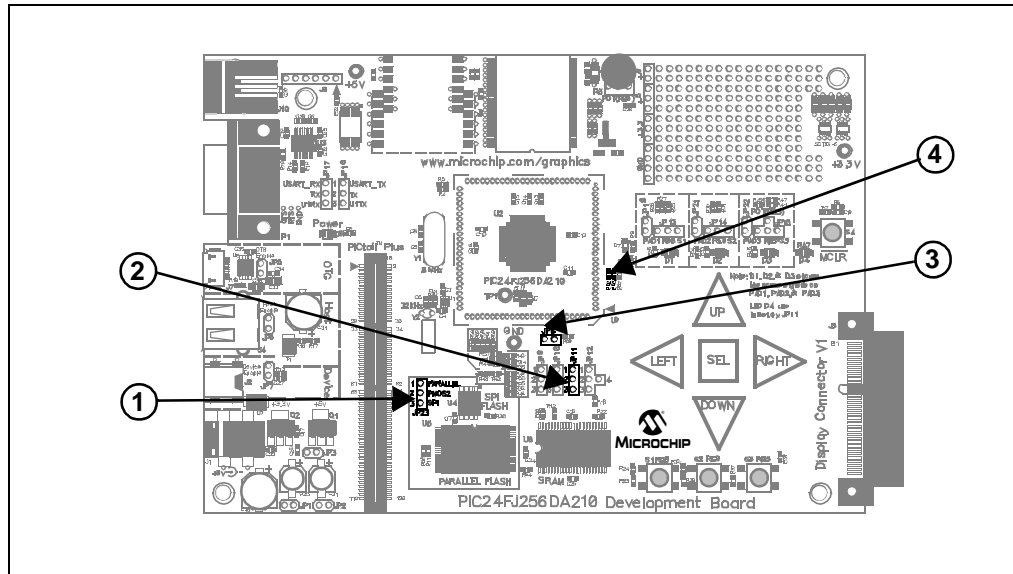

4.4.5.2.1 Serial Flash Memory

To use the SPI Flash memory, set jumper JP23 to bridge pins 2 and 3 (PMCS2 – SPI). The microcontroller’s SPI module is used to communicate with the memory device; the PMCS2 signal is used as the Chip Select signal.

4.4.5.2.2 Parallel Flash Memory

Like the SRAM, the on-board parallel Flash memory can be configured to use one of three memory address ranges (shown in Table 4-8).

TABLE 4-8: PARALLEL FLASH MEMORY RANGES

Size	JP11	R63	Active EPMP Address Lines	Recommended Part #
256 Kbyte (default)	Open	Open	PMA<16:0>	SST39LF400A-55-4C-EKE
512 Kbyte	Bridged	Open	PMA<17:0>	
1 Mbyte	Bridged	0Ω	PMA<18:0>	SST39VF800A-70-4C-EKE

PIC24FJ256DA210 Development Board User's Guide

To configure the 256 KByte address range (default):

1. Set jumper JP23 (callout 1) to position 1-2 (enables the parallel Flash memory).
2. Set JP11 (callout 2) to position 1-2 to connect PMA17 to LED D4 only, and use that microcontroller pin to control the LED.
Alternatively, remove jumper JP11 (disconnects PMA17 signal entirely).
3. If installed, remove resistor R63 (callout 4) (disconnects PMA18 signal from Flash memory).

To configure the 512 KByte address range:

1. Set jumper JP23 (callout 1) to position 1-2 (enables parallel Flash memory).
2. Set jumper JP11 (callout 2) to position 2-3 (connects PMA17 signal to Flash memory).
3. If installed, remove resistor R63 (callout 4) (disconnects PMA18 signal from Flash memory).

To configure the 1024 KByte address range (assuming U5 is populated with a 1 Mbyte device):

1. Set jumper JP23 to position 1-2 (callout 1) (enables parallel Flash memory).
2. Set jumper JP11 (callout 2) position 2-3 (connects PMA17 signal to Flash memory).
3. Populate resistor R63 (callout 4) with a 0Ω resistor (connects PMA18 signal to Flash memory).
4. If installed, remove resistor R62 (callout 4) (disconnects PMA18 from the PICtail Plus expansion port).

4.4.6 PICtail™ Plus Card Modular Expansion Connector

A 120-pin PICtail Plus connector (J8) is provided on the PIC24FJ256DA210 Development Board for expansion and integration of other solutions. At the time of this writing, the following daughter boards are supported on the PIC24FJ256DA210 Development Board:

- PICtail Daughter Board for SD & MMC Cards (AC164122)
- Ethernet PICtail Plus Daughter Board (AC164123)
- Fast 100 Mbps Ethernet PICtail Plus Daughter Board (AC164132)
- MRF24WB0MA PICtail Plus Daughter Board (AC164136-4)
- MRF49XA PICtail Plus Daughter Board (AC164137-1 or AC164137-2)
- Speech Playback PICtail Plus Daughter Board (AC164125)
- IrDA® PICtail Plus Daughter Board (AC164124)

Additional boards are planned to be available in the future. Users are encouraged to check the Microchip web site periodically for more information.

To enable the support of multiple PICtail Plus Daughter Boards, the development board maps selected I/Os to multiple PICtail Plus pins. In some cases, using certain daughter boards may mean disabling some functionality on the development board. In general, when the PICtail Plus connector is in use, these development board features are not available:

1. All CTMU channels (most daughter boards).
2. EPMP Address lines PMA18 and PMA17. This reduces the accessible area of the parallel Flash device to 256 Kbytes, regardless of the device installed
3. PMP Byte Enable line PMBE1. This limits parallel Flash and SRAM devices to Word accesses; in turn, this limits display modes to 16 bpp mode.
4. USB OTG functionality (Device and Host modes are still available)

Appendix A. Development Board Schematics

A.1 INTRODUCTION

This section provides detailed technical information on the PIC24FJ256DA210 Development Board. All information in this appendix refers to revision 1.1 of the development board.

A.2 HARDWARE FEATURES

TABLE A-1: CONNECTOR SUMMARY

Connector	Description
J1	Unregulated 9V to 15V power supply connector (PJ-0029)
J2	USB Device Mode (Mini B type) Connector
J3	Microchip Display Connector
J4	USB Host Mode (Type A) Connector
J7	USB OTG Mode (Micro AB type) Connector
J8	PICtail™ Plus 120-pin Edge Connector for Daughter Board expansion
J9	PICkit™ Program and Debug connector (6-pin riser)
J10	ICD Program and Debug connector (RJ-11)
P1	RS-232 (DB-9F) Serial Connector

PIC24FJ256DA210 Development Board User's Guide

TABLE A-2: SUMMARY OF ALL JUMPER SELECTIONS

Jumper	Function	Jumper Setting
JP5	Connect VBUS for USB OTG operation	Bridged
	USB OTG is not used (default)	Open
JP6	Connect VBUS for USB Embedded Host operation (default)	Bridged
	Embedded USB Host operation is not used	Open
JP7	Connect VBUS for USB Device operation	Bridged
	USB Device operation is not used (default)	Open
JP8	Connect PMBE1 to Upper Byte signal of External RAM (U6) (default)	Bridged
	Open, PMBE1 can be used in PICtail™ Plus Expansion Port	Open
JP9	Y- signal of resistive touch screen is connected to RA1 (default)	1-2
	SPI touch screen signal TC_CS is connected to RA1	2-3
JP10	X+ signal of resistive touch screen is connected to RC4 (default)	1-2
	SPI touch screen interrupt PEN_INT is connected to RC4	2-3
JP11	PMA17/RA7 signal is connected to LED D4 (default)	1-2
	PMA17/RA7 signal is connected to memory address line 17	2-3
JP12	Backlight PWM controlled signal (BKLT_PWM) is connected to RD0	1-2
	Backlight signal BKLT_EN is connected to RD0	2-3
	Serial RX signal is connected to RD0 (default)	2-4
JP13	Switch S1 connected to AN19/ RG8 (default)	1-2
	CTMU PAD1 and LED D1 connected to AN19/ RG8	2-3
JP14	Switch S2 connected to AN21/ RE9 (default)	1-2
	CTMU PAD2 and LED D2 connected to AN21/ RE9	2-3
JP15	Switch S3 connected to AN5/ RB5 (default)	1-2
	CTMU PAD3 and LED D3 connected to AN5/ RB5	2-3
	Potentiometer POT R3 connected to AN5/ RB5	2-4
JP16	Serial TX signal connected to USART_TX of RS-232 level shifter (default)	1-2
	Serial TX signal connected to U1TX of PICtail Plus Port	2-3
JP17	Serial RX signal connected to USART_RX of RS-232 level shifter (default)	1-2
	Serial RX signal connected to U1RX of PICtail Plus Port	2-3
JP23	PMCS2 signal connected to parallel Flash memory chip select	1-2
	PMCS2 signal connected to SPI Flash memory chip select (default)	2-3

Legend: **Bold** text indicates jumper labelling on development board in the absence of numbering (JP13 through JP15).

PIC24FJ256DA210 Development Board User's Guide

FIGURE A-2: DEVELOPMENT BOARD SCHEMATIC, SHEET 2 OF 7 (SWITCHES, POTENTIOMETER AND TOUCH PADS)

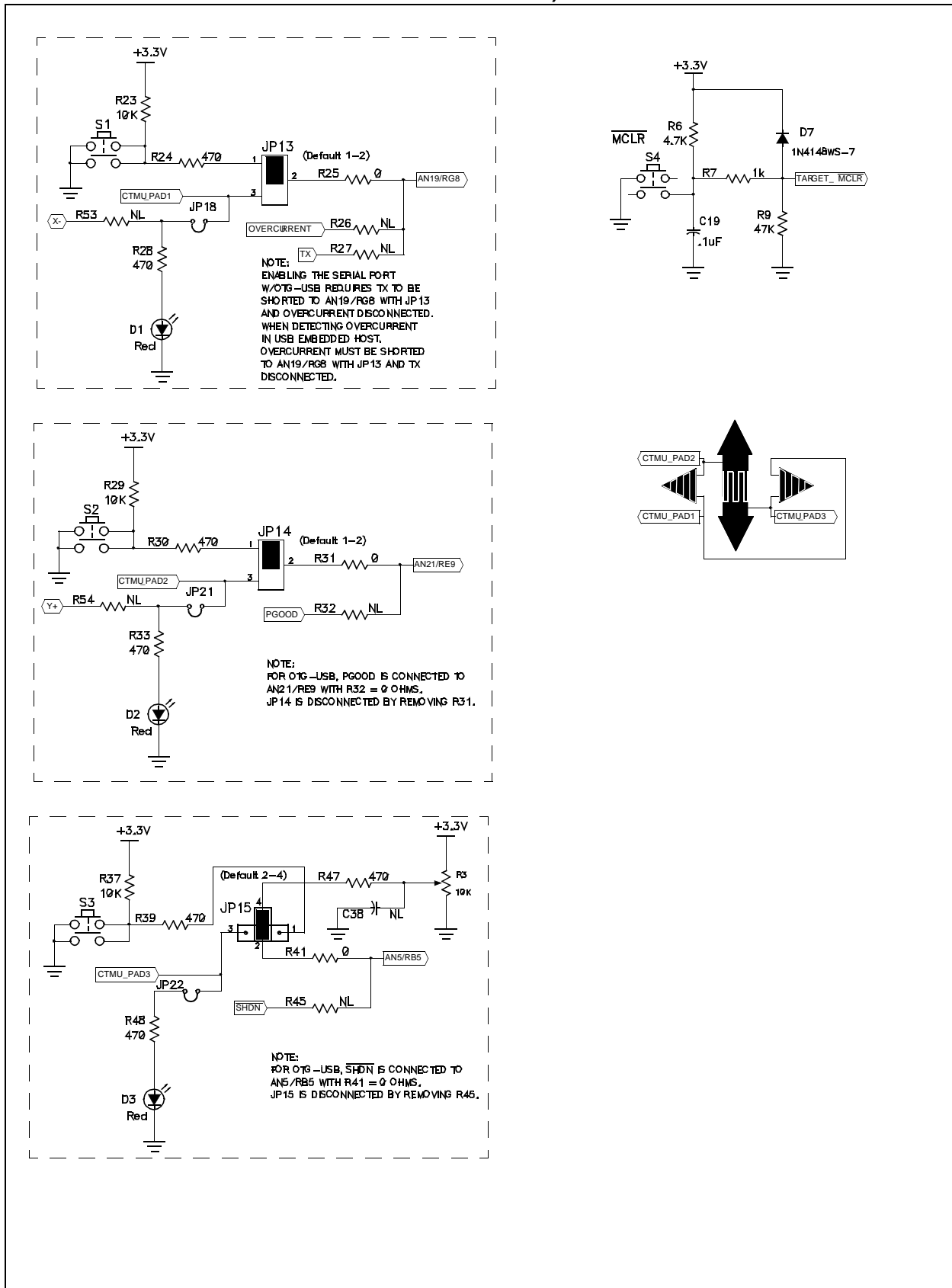

Development Board Schematics

FIGURE A-3: DEVELOPMENT BOARD SCHEMATIC, SHEET 3 OF 7 (FLASH AND SRAM OPTIONS)

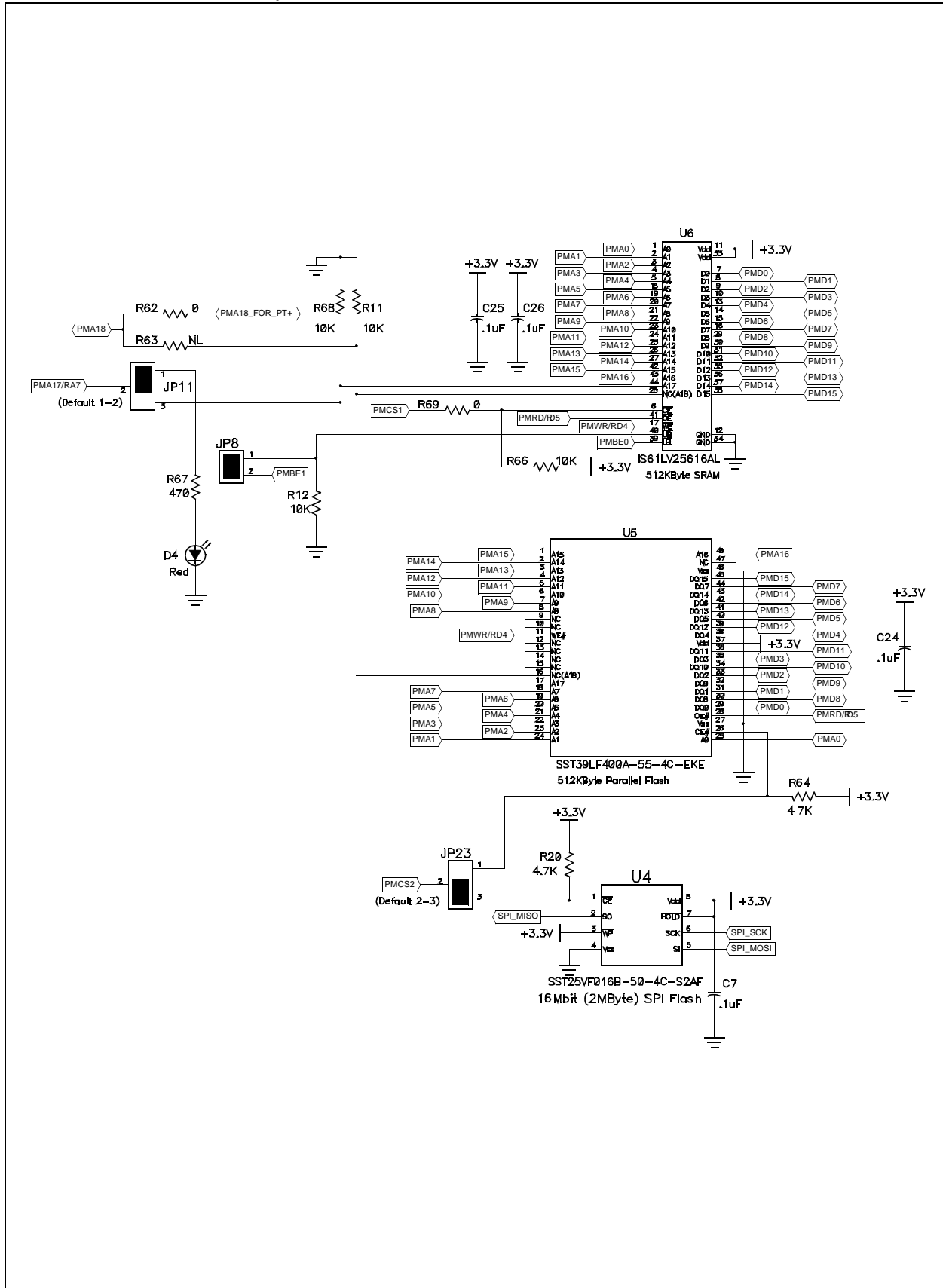

Development Board Schematics

FIGURE A-5: DEVELOPMENT BOARD SCHEMATIC, SHEET 5 OF 7 (DISPLAY EDGE CONNECTOR, ICD AND PICKIT™ CONNECTORS)

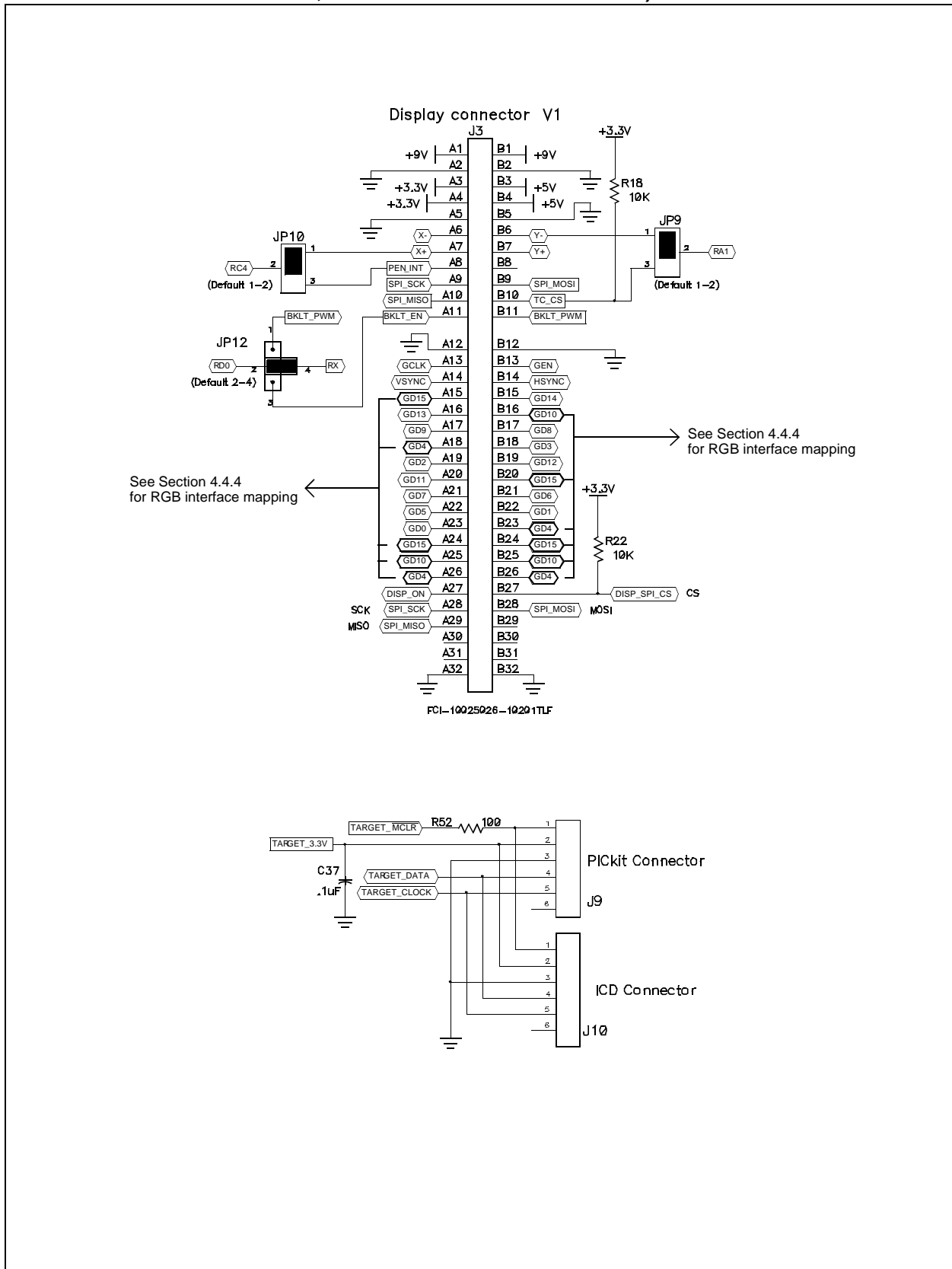

PIC24FJ256DA210 Development Board User's Guide

FIGURE A-6: DEVELOPMENT BOARD SCHEMATIC, SHEET 6 OF 7 (PICtail™ PLUS CONNECTOR AND PICtail CONFIGURATION OPTIONS)

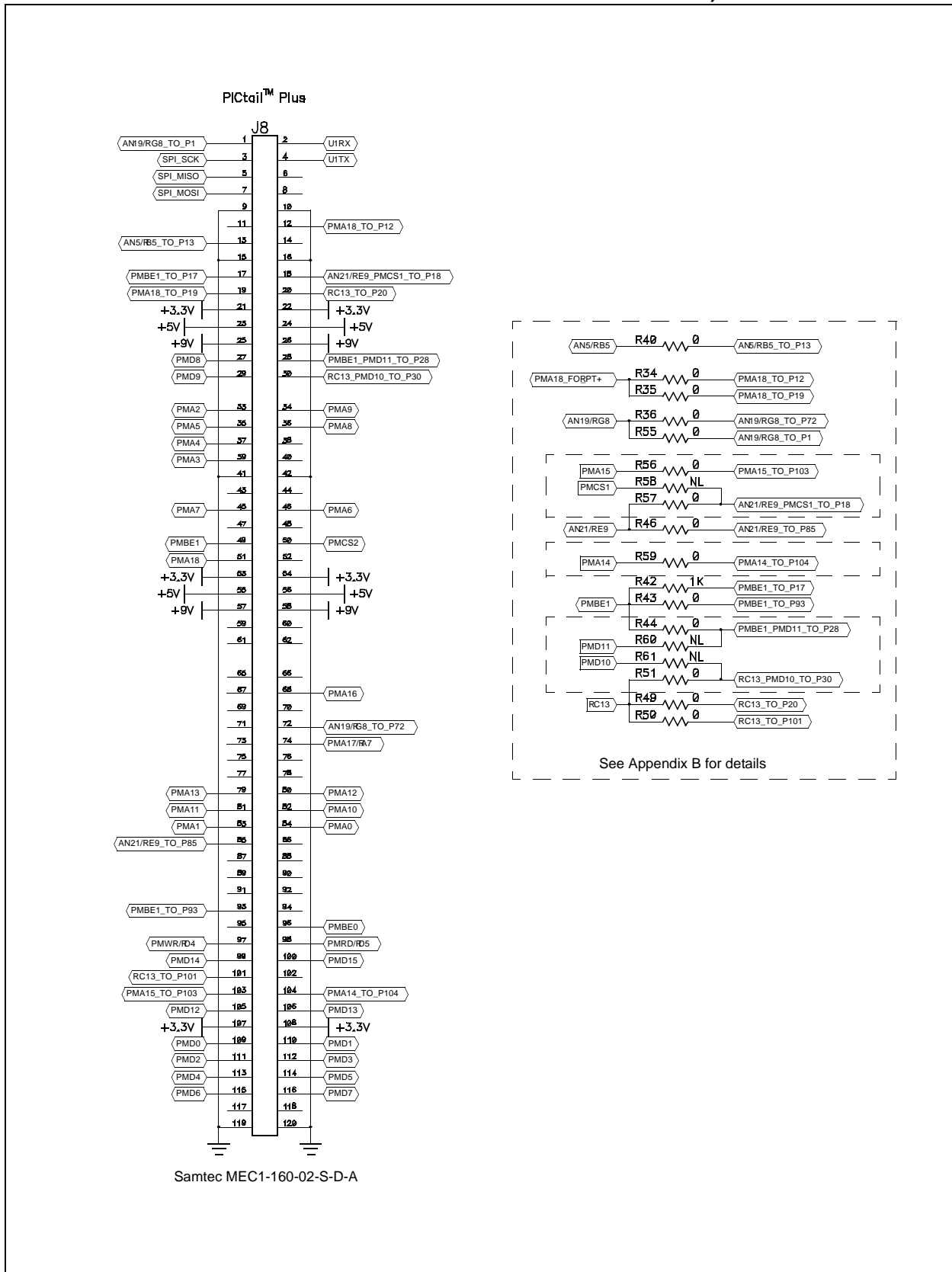

Development Board Schematics

FIGURE A-7: DEVELOPMENT BOARD SCHEMATIC, SHEET 7 OF 7 (MICROCONTROLLER HEADER)

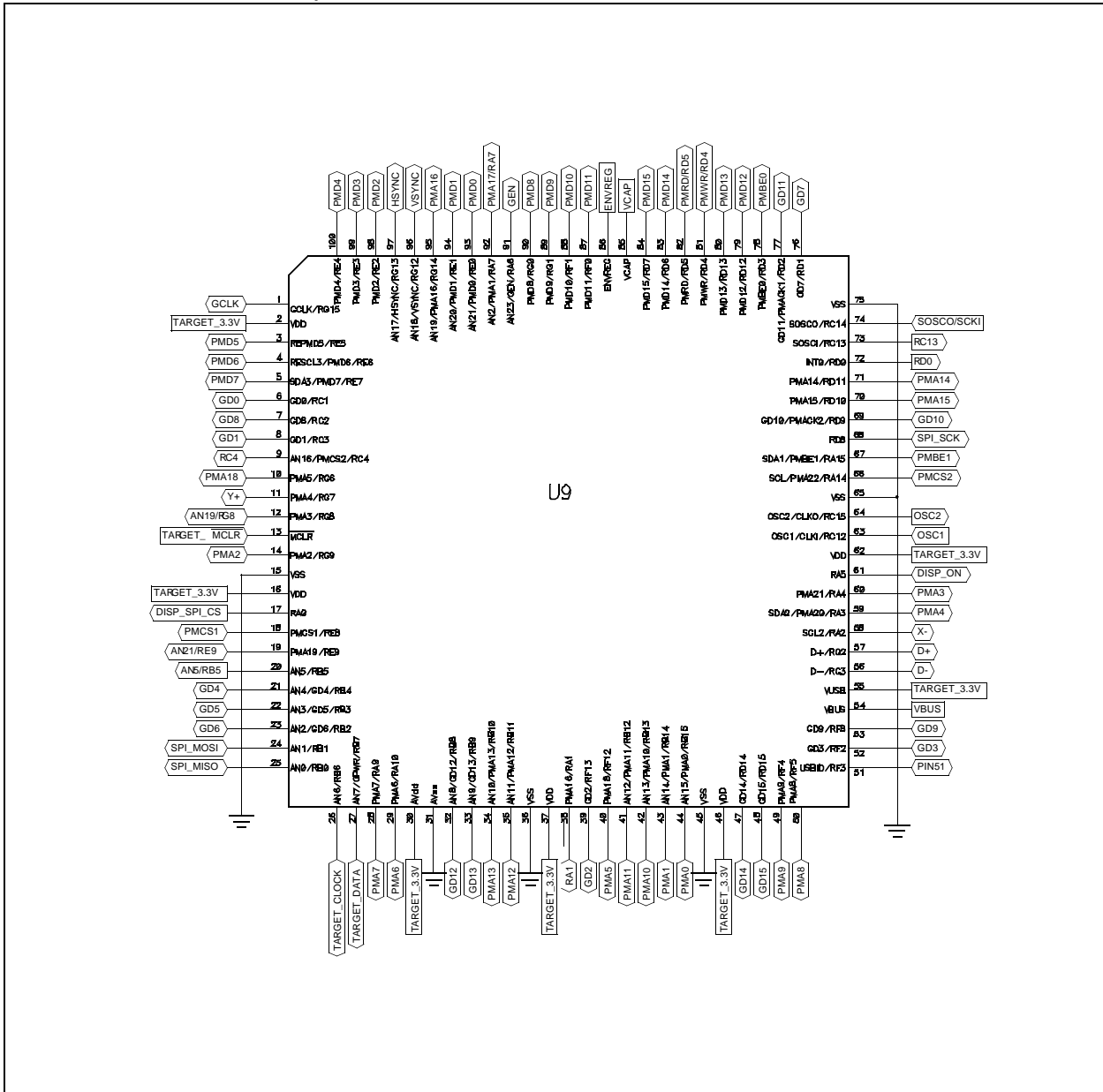

PIC24FJ256DA210 Development Board User's Guide

NOTES:

Appendix B. Modifications for PICtail Plus Daughter Boards

B.1 INTRODUCTION

This appendix provides a detailed description of the modifying the development board for use with different PICtail Plus daughter boards. Topics include:

- Overview of the PICtail Plus Interface
- Modifications for Specific Daughter Boards

B.2 OVERVIEW OF THE PICTAIL PLUS INTERFACE

To maximize their versatility, many of Microchip's development and demonstration boards are equipped with the PICtail Plus interface. This allows boards with a standardized edge connector to directly access the I/O lines of each other's microcontrollers and expand their functionality. In most cases, this is used to allow a more fully-featured board (such as the PIC24FJ256DA210 Development Board) to connect to a PICtail Plus daughter card and add new features to a pretape application (for example, adding 100 Mbps Ethernet using the Fast 100 Mbps Ethernet Daughter Board).

The basis for the design of the PICtail Plus interface is Microchip's adherence to a standard migration pathway throughout its microcontroller families: that is, for a given microcontroller package pin count, certain I/O ports are always located on specific pins of the PICtail Plus interface, and specific peripherals are almost always associated with specific I/O ports. This permits daughter boards to use a specific pin for SPI communication, for example, because microcontrollers will always have an SPI peripheral associated with that I/O pin, and that PICtail Plus connector pin.

There are exceptions, however. Because of its complex graphics interface and enhanced PMP, the PIC24FJ256DA210 microcontroller does not map I/O ports and peripherals in the same way as other 100-pin devices are mapped. To maximize compatibility, this requires a change of the PICtail Plus mapping for the PIC24FJ256DA210 Development Board. The complete mapping from microcontroller to interface are shown in Table B-1.

Since PICtail Plus-compatible daughter boards are designed to the standard interface, some additional remapping of the interface is needed to make the PIC24FJ256DA210 Development Board compatible. Provisions to do this are made by connecting a group of I/O lines the resistor bank described in **Section 4.4.6 "PICtail™ Plus Card Modular Expansion Connector"**. Populating or removing specific resistors in this bank allows the remapping of certain signals and restoring compatibility with specific daughter boards. As of this writing, the development board can be made compatible with all available PICtail Plus daughter boards.

A list of specific signals controlled by the resistor bank is provided in Table B-2; note that some signals are routed to multiple pins on the PICtail Plus interface by default to maximize compatibility. Table B-3 shows the same information to specifically highlight which signals can be remapped to a particular pin.

Section B.3 "Modifications for Specific Daughter Boards" describes the specific resistor changes required for each PICtail Plus daughter board.

PIC24FJ256DA210 Development Board User's Guide

TABLE B-1: COMPLETE MICROCONTROLLER TO PICtail™ PLUS CONNECTOR PIN MAPPING

PICtail™ Plus		PIC24FJ256DA210 I/O Pin (#)	PICtail Plus		PIC24FJ256DA210 I/O Pin (#)
Pin	Standard Signal		Pin	Standard Signal	
1	RB2	AN19/RG8/CTMU1 (12) ⁽¹⁾	68	RG14	PMA16 (95)
2	RF2	RP11/RD0 (72)	72	RA5	AN19/RG8/CTMU1 (12) ⁽¹⁾
3	RF6	RP2/RD8 (68)	74	RA7	PMA17/RA7 (92)
4	RF3	RP16/RF3 (51)	79	RB10	PMA13 (34)
5	RF7	AN1/RP1/RB1 (24)	80	RB11	PMA12 (35)
6	RG2	N/C	81	RB12	PMA11 (41)
7	RF8	AN0/RP0/RB0 (25)	82	RB13	PMA10 (42)
12	RB1	AN17/PMA18/RG6 (10) ⁽¹⁾	83	RB14	PMA1 (43)
13	RB3	AN5/RB5/CTMU3 (20)	84	RB15	PMA0 (44)
17	RE9	PMBE1/RA15 (67)	85	RC1	AN21/RE9/CTMU2 (19) ⁽¹⁾
18	RE8	AN21/RE9/CTMU2 (19) ⁽¹⁾	93	RD0	PMBE1/RA15 (67) ⁽¹⁾
19	RD14	AN17/PMA18/RG6 (10) ⁽¹⁾	96	RD3	PMBE0 (78)
20	RD15	RC13 (73)	97	RD4	PMWR (81)
27	RG0	N/C	98	RD5	PMRD (82)
28	RF0	PMBE1/RA15 (67) ⁽¹⁾	99	RD6	PMD14 (83)
29	RG1	PMD9 (89)	100	RD7	PMD15 (84)
30	RF1	RC13 (73)	101	RD8	RC13(73)
33	RG9	PMA2 (14)	103	RD10	PMA15 (70)
34	RF4	PMA9 (49)	104	RD11	PMA14 (71)
35	RG6	PMA5 (40)	105	RD12	PMD12 (35)
36	RF5	PMA8 (50)	106	RD13	PMD13 (34)
37	RG7	PMA4 (59)	109	RE0	PMD0 (93)
39	RG8	PMA3 (60)	110	RE1	PMD1 (94)
42	GND	N/C	111	RE2	PMD2 (98)
45	RA9	PMA7 (28)	112	RE3	PMD3 (99)
46	RA10	PMA6 (29)	113	RE4	PMD4 (100)
49	RA15	PMBE1 (67)	114	RE5	PMD5 (3)
50	RA14	PMCS2 (66)	115	RE6	PMD6 (4)
51	RF12	PMA18 (10)	116	RE7	PMD7 (5)

Note 1: Each of these signals appears on two or more PICtail Plus pins.

Modifications for PICtail Plus Daughter Boards

TABLE B-2: DEFAULT SIGNAL ROUTING TO PICtail™ PLUS CONNECTOR (BY SIGNAL)

Microcontroller Pin	PT+ Pin #	Resistor	PT+ Pin #	Resistor	PT+ Pin #	Resistor
AN5/RB5	13	R40 (0)	—	—	—	—
AN19/RG8	1	R55 (0)	72	R36 (0)	—	—
AN21/RE9	85	R46 (0)	18	R57 (0)	—	—
PMA14	104	R59 (0)	—	—	—	—
PMA15	103	R56 (0)	—	—	—	—
PMA18	12	R34 (0)	19	R35 (0)	—	—
PMD10	30 ⁽¹⁾	R61 (N/C)	—	—	—	—
PMD11	28 ⁽¹⁾	R60 (N/C)	—	—	—	—
PMBE1	17	R42 (1k)	93	R43 (0)	28	R44 (0)
PMCS1	18 ⁽¹⁾	R58 (N/C)	—	—	—	—
RC13	20	R49 (0)	101	R50 (0)	30	R51 (0)

Legend: Parenthesis indicates resistance in ohms; N/C – no resistor present; PT+ – PICtail™ Plus

Note 1: Signal disconnected from this pin by default.

TABLE B-3: DEFAULT AND OPTIONAL SIGNAL ROUTINGS TO PICtail™ PLUS CONNECTOR

PICtail™ Plus Pin #	Connected Signal(s)	Optional Signal(s)
1	AN19/RG8 ⁽¹⁾	—
12	PMA18 ⁽¹⁾	—
13	AN5/RB5	—
17	PMBE1	—
18	AN21/RE9 ⁽¹⁾	PMCS1
19	PMA18 ⁽¹⁾	—
20	RC13 ⁽¹⁾	—
28	PMBE1 ⁽¹⁾	PMD11
30	RC13 ⁽¹⁾	PMD10
72	AN19/RG8 ⁽¹⁾	—
85	AN21/RE9 ⁽¹⁾	—
93	PMBE1 ⁽¹⁾	—
101	RC13 ⁽¹⁾	—
103	PMA13	—
104	PMA14	—

Note 1: Signal appears on multiple PICtail Plus pins by default.

PIC24FJ256DA210 Development Board User's Guide

B.3 MODIFICATIONS FOR SPECIFIC DAUGHTER BOARDS

The configuration resistor changes that are required to make the development board function with available PICtail Plus daughter boards are listed below. This list is complete for compatible boards that were available at the time of publication. Note that some daughter boards are compatible as provided, and that no modifications are required.

Daughter boards released by Microchip subsequent to this publication may be compatible with the development board. The user may use the schematics in Appendix A and the daughter board to verify signal compatibility.

B.3.1 Fast 100 Mbps Ethernet Daughter Board (AC164132)

Three hardware changes are required:

- Enable PMP Data 10 (PMD10) by populating R61 and removing R51
- Enable PMP Data 11 (PMD11) by populating R60 and removing R44
- Enable PMP CS signal (PMCS1) by populating R58 and removing R57

B.3.2 PICtail Board for SD & MMC (AC164122)

Two hardware changes are required:

- Enable Write Protect (WD) by populating R51 (default) and removing R61
- Enable Card Detect (CD) by populating R60 (default) and removing R44

B.3.3 MRF49XA PICtail/PICtail Plus Daughter Board (AC164137-1 and AC164137-2)

One hardware change is required:

- Enable EEPROM Chip Select (EE_nCS) by populating R51 (default) and removing R61

B.3.4 Directly Compatible Daughter Boards

No hardware modifications to the PIC24FJ256DA210 Development Board are required when these daughter boards are used:

- Ethernet PICtail Plus Daughter Board (AC164123)
- Speech Playback PICtail Plus Daughter Board (AC164125)
- IrDA PICtail Plus Daughter Board (AC164124)

Index

B	
Building Code.....	22
C	
Configuration	
Analog Input (Potentiometer).....	37
Board Configuration vs Availability of Features.....	35
EPMP Alternate Configuration.....	48
External Memory	
Flash Memory.....	45
SRAM.....	43
Graphics Port.....	41
Backlight Control.....	43
Touch Screen Interface.....	42
Jumper Locations.....	34, 50
LEDs.....	37
PICtail Plus Connector	
Hardware Modifications.....	47, 59–62
PICtail Plus Connector.....	46
Push Button Switches.....	36
Touch Sensors.....	37
UART.....	39
RX Signal and Backlight.....	41
TX Remapping.....	40
USB.....	38–39
Connectors.....	49
CTMU Touch Sensors.....	37
Current Measurement.....	47
Customer Notification Service.....	9
Customer Support.....	9
D	
Debugging Code.....	27
Demonstration Application (pre-programmed).....	17
Demonstration Programs.....	15
Development Board Block Diagram.....	32
Diagrams	
Block Diagram.....	32
Configuring User-Defined Features.....	36
Current Measurement.....	48
Development Board Layout.....	12
Flash Memory Configuration.....	45
Jumper Locations.....	34
PICtail Plus Configuration Resistors.....	47
SRAM Configuration.....	44
Touch Controller and Backlight Configuration.....	42
UART Configuration.....	40
USB Mode Configuration.....	38
Documentation	
Conventions.....	6
Layout.....	5
E	
External SRAM.....	43
F	
Flash Memory.....	45
I	
Internet Address.....	8
L	
Loading a Software Project.....	20
M	
MCLR.....	33, 16, 8
O	
Oscillator Options.....	33
P	
PCB Layout Features.....	32
PICtail Plus Connector Pin Mapping.....	60
Potentiometer.....	37
Power Requirements.....	13
Power Supply Options.....	33
Programming the PIC24FJ256DA210.....	23
Programming/Debugging Interface.....	33
Push Button Switches.....	36
R	
Reading, Recommended.....	7
Reset Switch.....	33
Running Code.....	26
S	
Schematics.....	51–57
Software for Application Development.....	16
U	
UART.....	39
USB On-the-Go mode.....	39
Using Breakpoints and Mouseovers.....	28
Using Watch Windows.....	29
W	
WWW Address.....	8



WORLDWIDE SALES AND SERVICE

AMERICAS

Corporate Office
2355 West Chandler Blvd.
Chandler, AZ 85224-6199
Tel: 480-792-7200
Fax: 480-792-7277
Technical Support:
<http://support.microchip.com>
Web Address:
www.microchip.com

Atlanta
Duluth, GA
Tel: 678-957-9614
Fax: 678-957-1455

Boston
Westborough, MA
Tel: 774-760-0087
Fax: 774-760-0088

Chicago
Itasca, IL
Tel: 630-285-0071
Fax: 630-285-0075

Cleveland
Independence, OH
Tel: 216-447-0464
Fax: 216-447-0643

Dallas
Addison, TX
Tel: 972-818-7423
Fax: 972-818-2924

Detroit
Farmington Hills, MI
Tel: 248-538-2250
Fax: 248-538-2260

Kokomo
Kokomo, IN
Tel: 765-864-8360
Fax: 765-864-8387

Los Angeles
Mission Viejo, CA
Tel: 949-462-9523
Fax: 949-462-9608

Santa Clara
Santa Clara, CA
Tel: 408-961-6444
Fax: 408-961-6445

Toronto
Mississauga, Ontario,
Canada
Tel: 905-673-0699
Fax: 905-673-6509

ASIA/PACIFIC

Asia Pacific Office
Suites 3707-14, 37th Floor
Tower 6, The Gateway
Harbour City, Kowloon
Hong Kong
Tel: 852-2401-1200
Fax: 852-2401-3431

Australia - Sydney
Tel: 61-2-9868-6733
Fax: 61-2-9868-6755

China - Beijing
Tel: 86-10-8528-2100
Fax: 86-10-8528-2104

China - Chengdu
Tel: 86-28-8665-5511
Fax: 86-28-8665-7889

China - Chongqing
Tel: 86-23-8980-9588
Fax: 86-23-8980-9500

China - Hong Kong SAR
Tel: 852-2401-1200
Fax: 852-2401-3431

China - Nanjing
Tel: 86-25-8473-2460
Fax: 86-25-8473-2470

China - Qingdao
Tel: 86-532-8502-7355
Fax: 86-532-8502-7205

China - Shanghai
Tel: 86-21-5407-5533
Fax: 86-21-5407-5066

China - Shenyang
Tel: 86-24-2334-2829
Fax: 86-24-2334-2393

China - Shenzhen
Tel: 86-755-8203-2660
Fax: 86-755-8203-1760

China - Wuhan
Tel: 86-27-5980-5300
Fax: 86-27-5980-5118

China - Xian
Tel: 86-29-8833-7252
Fax: 86-29-8833-7256

China - Xiamen
Tel: 86-592-2388138
Fax: 86-592-2388130

China - Zhuhai
Tel: 86-756-3210040
Fax: 86-756-3210049

ASIA/PACIFIC

India - Bangalore
Tel: 91-80-3090-4444
Fax: 91-80-3090-4123

India - New Delhi
Tel: 91-11-4160-8631
Fax: 91-11-4160-8632

India - Pune
Tel: 91-20-2566-1512
Fax: 91-20-2566-1513

Japan - Yokohama
Tel: 81-45-471- 6166
Fax: 81-45-471-6122

Korea - Daegu
Tel: 82-53-744-4301
Fax: 82-53-744-4302

Korea - Seoul
Tel: 82-2-554-7200
Fax: 82-2-558-5932 or
82-2-558-5934

Malaysia - Kuala Lumpur
Tel: 60-3-6201-9857
Fax: 60-3-6201-9859

Malaysia - Penang
Tel: 60-4-227-8870
Fax: 60-4-227-4068

Philippines - Manila
Tel: 63-2-634-9065
Fax: 63-2-634-9069

Singapore
Tel: 65-6334-8870
Fax: 65-6334-8850

Taiwan - Hsin Chu
Tel: 886-3-6578-300
Fax: 886-3-6578-370

Taiwan - Kaohsiung
Tel: 886-7-536-4818
Fax: 886-7-536-4803

Taiwan - Taipei
Tel: 886-2-2500-6610
Fax: 886-2-2508-0102

Thailand - Bangkok
Tel: 66-2-694-1351
Fax: 66-2-694-1350

EUROPE

Austria - Wels
Tel: 43-7242-2244-39
Fax: 43-7242-2244-393

Denmark - Copenhagen
Tel: 45-4450-2828
Fax: 45-4485-2829

France - Paris
Tel: 33-1-69-53-63-20
Fax: 33-1-69-30-90-79

Germany - Munich
Tel: 49-89-627-144-0
Fax: 49-89-627-144-44

Italy - Milan
Tel: 39-0331-742611
Fax: 39-0331-466781

Netherlands - Drunen
Tel: 31-416-690399
Fax: 31-416-690340

Spain - Madrid
Tel: 34-91-708-08-90
Fax: 34-91-708-08-91

UK - Wokingham
Tel: 44-118-921-5869
Fax: 44-118-921-5820

Компания «Океан Электроники» предлагает заключение долгосрочных отношений при поставках импортных электронных компонентов на взаимовыгодных условиях!

Наши преимущества:

- Поставка оригинальных импортных электронных компонентов напрямую с производств Америки, Европы и Азии, а так же с крупнейших складов мира;
- Широкая линейка поставок активных и пассивных импортных электронных компонентов (более 30 млн. наименований);
- Поставка сложных, дефицитных, либо снятых с производства позиций;
- Оперативные сроки поставки под заказ (от 5 рабочих дней);
- Экспресс доставка в любую точку России;
- Помощь Конструкторского Отдела и консультации квалифицированных инженеров;
- Техническая поддержка проекта, помощь в подборе аналогов, поставка прототипов;
- Поставка электронных компонентов под контролем ВП;
- Система менеджмента качества сертифицирована по Международному стандарту ISO 9001;
- При необходимости вся продукция военного и аэрокосмического назначения проходит испытания и сертификацию в лаборатории (по согласованию с заказчиком);
- Поставка специализированных компонентов военного и аэрокосмического уровня качества (Xilinx, Altera, Analog Devices, Intersil, Interpoint, Microsemi, Actel, Aeroflex, Peregrine, VPT, Syfer, Eurofarad, Texas Instruments, MS Kennedy, Miteq, Cobham, E2V, MA-COM, Hittite, Mini-Circuits, General Dynamics и др.);

Компания «Океан Электроники» является официальным дистрибьютором и эксклюзивным представителем в России одного из крупнейших производителей разъемов военного и аэрокосмического назначения «JONHON», а так же официальным дистрибьютором и эксклюзивным представителем в России производителя высокотехнологичных и надежных решений для передачи СВЧ сигналов «FORSTAR».



JONHON

«JONHON» (основан в 1970 г.)

Разъемы специального, военного и аэрокосмического назначения:

(Применяются в военной, авиационной, аэрокосмической, морской, железнодорожной, горно- и нефтедобывающей отраслях промышленности)

«FORSTAR» (основан в 1998 г.)

ВЧ соединители, коаксиальные кабели, кабельные сборки и микроволновые компоненты:

(Применяются в телекоммуникациях гражданского и специального назначения, в средствах связи, РЛС, а так же военной, авиационной и аэрокосмической отраслях промышленности).



Телефон: 8 (812) 309-75-97 (многоканальный)

Факс: 8 (812) 320-03-32

Электронная почта: ocean@oceanchips.ru

Web: <http://oceanchips.ru/>

Адрес: 198099, г. Санкт-Петербург, ул. Калинина, д. 2, корп. 4, лит. А