

# ADS1286

## 12-Bit Micro Power Sampling ANALOG-TO-DIGITAL CONVERTER

### FEATURES

- SERIAL INTERFACE
- GUARANTEED NO MISSING CODES
- 20kHz SAMPLING RATE
- LOW SUPPLY CURRENT: 250 $\mu$ A

### APPLICATIONS

- REMOTE DATA ACQUISITION
- ISOLATED DATA ACQUISITION
- TRANSDUCER INTERFACE
- BATTERY OPERATED SYSTEMS

### DESCRIPTION

The ADS1286 is a 12-bit, 20kHz analog-to-digital converter with a differential input and sample and hold amplifier and consumes only 250 $\mu$ A of supply current. The ADS1286 offers an SPI and SSI compatible serial interface for communications over a two or three wire interface. The combination of a serial two wire interface and micropower consumption makes the ADS1286 ideal for remote applications and for those requiring isolation.

The ADS1286 is available in a 8-pin plastic mini DIP and a 8-lead SOIC.

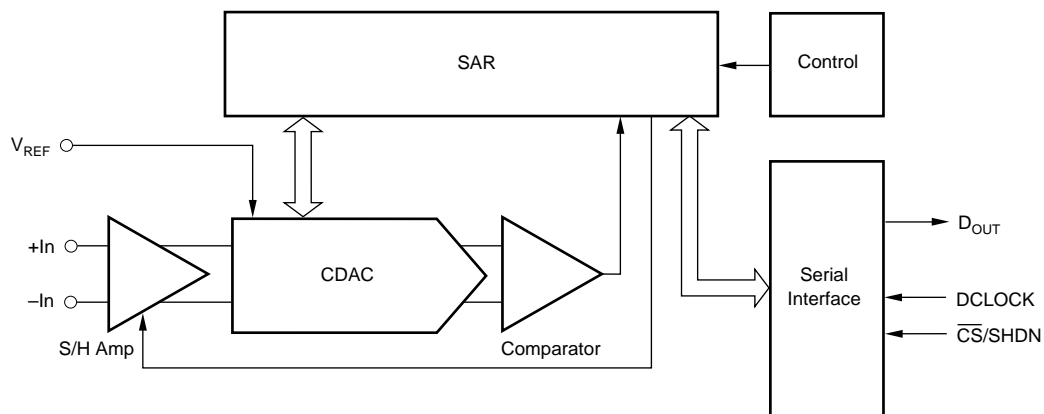

# SPECIFICATIONS

At  $T_A = T_{MIN}$  to  $T_{MAX}$ ,  $+V_{CC} = +5V$ ,  $V_{REF} = +5V$ ,  $f_{SAMPLE} = 12.5kHz$ ,  $f_{CLK} = 16 \cdot f_{SAMPLE}$ , unless otherwise specified.

PARAMETER	CONDITIONS	ADS1286, ADS1286A			ADS1286K, ADS1286B			ADS1286C, ADS1286L			UNITS
		MIN	TYP	MAX	MIN	TYP	MAX	MIN	TYP	MAX	
<b>ANALOG INPUT</b>											
Full-Scale Input Range	+In – (–In)	0		$V_{REF}$	*		*	*		*	V
Absolute Input Voltage	+In	–0.2		$V_{CC} + 0.2$	*		*	*		*	V
	–In	–0.2		+0.2	*		*	*		*	V
Capacitance			25			*			*		pF
Leakage Current			±1			*			*		µA
<b>SYSTEM PERFORMANCE</b>											
Resolution		12	12		*	*		*	*		Bits
No Missing Codes					*			*			Bits
Integral Linearity			±1	±2		*			±0.5	±1	LSB
Differential Linearity			±0.5	±1.0		*	±0.75		±0.25	±0.75	LSB
Offset Error			0.75	±3		*	*		*	*	LSB
Gain Error			±2	±8		*	*		*	*	LSB
Noise			50			*			*		µVrms
Power Supply Rejection			82			*			*		dB
<b>SAMPLING DYNAMICS</b>											
Conversion Time				12			*			*	Clk Cycles
Acquisition Time		1.5			*			*			Clk Cycles
Small Signal Bandwidth			500			*			*		kHz
<b>DYNAMIC CHARACTERISTICS</b>											
Total Harmonic Distortion	$V_{IN} = 5.0Vp-p$ at 1kHz		–85			*			*		dB
	$V_{IN} = 5.0Vp-p$ at 5kHz		–83			*			*		dB
SINAD	$V_{IN} = 5.0Vp-p$ at 1kHz		72			*			*		dB
Spurious Free Dynamic Range	$V_{IN} = 5.0Vp-p$ at 1kHz		90			*			*		dB
<b>REFERENCE INPUT</b>											
REF Input Range		1.25	2.5	$V_{CC} + 0.05V$	*	*	*	*	*	*	V
Input Resistance	$\overline{CS} = V_{CC}$		5000			*			*		MΩ
	$CS = GND, f_{CLK} = 0Hz$		5000			*			*		MΩ
Current Drain	$\overline{CS} = V_{CC}$		0.01	2.5		*	*		*	*	µA
	$t_{CYC} \geq 640\mu s, f_{CLK} \leq 25kHz$		2.4	20		*	*		*	*	µA
	$t_{CYC} = 80\mu s, f_{CLK} = 200kHz$		2.4	20		*	*		*	*	µA
<b>DIGITAL INPUT/OUTPUT</b>											
Logic Family			CMOS			*			*		
Logic Levels:											
$V_{IH}$	$I_{IH} = +5\mu A$	3		$+V_{CC}$	*		*	*	*	*	V
$V_{IL}$	$I_{IL} = +5\mu A$	0.0		0.8	*		*	*	*	*	V
$V_{OH}$	$I_{OH} = 250\mu A$	3		$+V_{CC}$	*		*	*	*	*	V
$V_{OL}$	$I_{OL} = 250\mu A$	0.0		0.4	*		*	*	*	*	V
Data Format			Straight Binary			*			*		
<b>POWER SUPPLY REQUIREMENTS</b>											
Power Supply Voltage		+4.50	5	5.25	*	*	*	*	*	*	V
Quiescent Current, $V_{ANA}$	$t_{CYC} \geq 640\mu s, f_{CLK} \leq 25kHz$		200	400		*	*		*	*	µA
	$t_{CYC} = 90\mu s, f_{CLK} = 200kHz$		250	500		*	*		*	*	µA
Power Down	$CS = V_{CC}$			3		*	*		*	*	µA
<b>TEMPERATURE RANGE</b>											
Specified Performance	ADS1286, K, L	0		+70	*		*	*	*	*	°C
	ADS1286A, B, C	–40		+85	*		*	*	*	*	°C

\* Specifications same as grade to the left.

## TIMING CHARACTERISTICS

$f_{CLK} = 200kHz$ ,  $T_A = T_{MIN}$  to  $T_{MAX}$ .

SYMBOL	PARAMETER	CONDITIONS	MIN	TYP	MAX	UNITS
$t_{SMPL}$	Analog Input Sample Time	See Operating Sequence	1.5		2.0	Clk Cycles
$f_{SMPL (MAX)}$	Maximum Sampling Frequency	ADS1286			20	kHz
$t_{CONV}$	Conversion Time	See Operating Sequence		12		Clk Cycles
$t_{DQO}$	Delay Time, DCLOCK↓ to D <sub>OUT</sub> Data Valid	See Test Circuits		85	150	ns
$t_{dis}$	Delay Time, $\overline{CS}$ ↑ to D <sub>OUT</sub> Hi-Z	See Test Circuits		25	50	ns
$t_{en}$	Delay Time, DCLOCK↓ to D <sub>OUT</sub> Enable	See Test Circuits		50	100	ns
$t_{hDO}$	Output Data Remains Valid After DCLOCK↓	$C_{LOAD} = 100pF$	15	30		ns
$t_f$	D <sub>OUT</sub> Fall Time	See Test Circuits		70	100	ns
$t_r$	D <sub>OUT</sub> Rise Time	See Test Circuits		60	100	ns
$t_{CSD}$	Delay Time, $\overline{CS}$ ↓ to DCLOCK↓	See Operating Sequence			0	ns
$t_{SUCS}$	Delay Time, $\overline{CS}$ ↓ to DCLOCK↑	See Operating Sequence	30			ns

## ABSOLUTE MAXIMUM RATINGS<sup>(1)</sup>

+V <sub>CC</sub> .....	+6V
Analog Input .....	-0.3V to (+V <sub>CC</sub> + 300mV)
Logic Input .....	-0.3V to (+V <sub>CC</sub> + 300mV)
Case Temperature .....	+100°C
Junction Temperature .....	+150°C
Storage Temperature .....	+125°C
External Reference Voltage .....	+5.5V

NOTE: (1) Stresses above these ratings may permanently damage the device.



## ELECTROSTATIC DISCHARGE SENSITIVITY

Electrostatic discharge can cause damage ranging from performance degradation to complete device failure. Burr-Brown Corporation recommends that all integrated circuits be handled and stored using appropriate ESD protection methods.

ESD damage can range from subtle performance degradation to complete device failure. Precision integrated circuits may be more susceptible to damage because very small parametric changes could cause the device not to meet published specifications.

## PIN CONFIGURATION

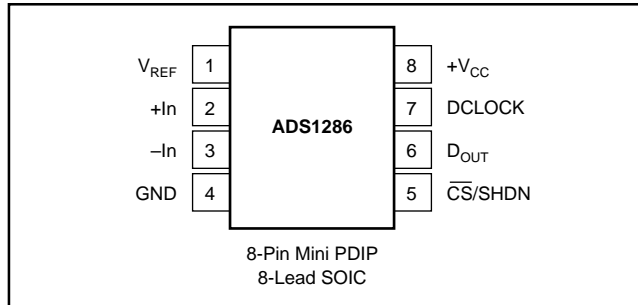

## PIN ASSIGNMENTS

PIN	NAME	DESCRIPTION
1	V <sub>REF</sub>	Reference Input.
2	+In	Non Inverting Input.
3	-In	Inverting Input. Connect to ground or remote ground sense point.
4	GND	Ground.
5	$\overline{\text{CS}}/\text{SHDN}$	Chip Select when low, Shutdown Mode when high.
6	D <sub>OUT</sub>	The serial output data word is comprised of 12 bits of data. In operation the data is valid on the falling edge of DCLOCK. The second clock pulse after the falling edge of CS enables the serial output. After one null bit the data is valid for the next 12 edges.
7	DCLOCK	Data Clock synchronizes the serial data transfer and determines conversion speed.
8	+V <sub>CC</sub>	Power Supply.

## PACKAGE/ORDERING INFORMATION

PRODUCT	INTEGRAL LINEARITY	TEMPERATURE RANGE	PACKAGE	PACKAGE DRAWING NUMBER <sup>(1)</sup>
ADS1286P	±2	0°C to +70°C	Plastic DIP	006
ADS1286PK	±2	0°C to +70°C	Plastic DIP	006
ADS1286PL	±1	0°C to +70°C	Plastic DIP	006
ADS1286U	±2	0°C to +70°C	SOIC	182
ADS1286UK	±2	0°C to +70°C	SOIC	182
ADS1286UL	±1	0°C to +70°C	SOIC	182
ADS1286PA	±2	-40°C to +85°C	Plastic DIP	006
ADS1286PB	±2	-40°C to +85°C	Plastic DIP	006
ADS1286PC	±1	-40°C to +85°C	Plastic DIP	006
ADS1286UA	±2	-40°C to +85°C	SOIC	182
ADS1286UB	±2	-40°C to +85°C	SOIC	182
ADS1286UC	±1	-40°C to +85°C	SOIC	182

NOTE: (1) For detailed drawing and dimension table, please see end of data sheet, or Appendix C of Burr-Brown IC Data Book.

The information provided herein is believed to be reliable; however, BURR-BROWN assumes no responsibility for inaccuracies or omissions. BURR-BROWN assumes no responsibility for the use of this information, and all use of such information shall be entirely at the user's own risk. Prices and specifications are subject to change without notice. No patent rights or licenses to any of the circuits described herein are implied or granted to any third party. BURR-BROWN does not authorize or warrant any BURR-BROWN product for use in life support devices and/or systems.

# TYPICAL PERFORMANCE CURVES

At  $T_A = +25$ ,  $V_{CC} = +5V$ ,  $V_{REF} = +5V$ ,  $f_{SAMPLE} = 12.5kHz$ ,  $f_{CLK} = 16 \cdot f_{SAMPLE}$ , unless otherwise specified.

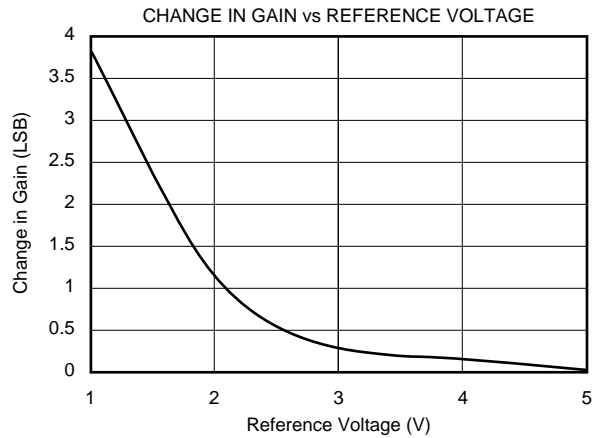
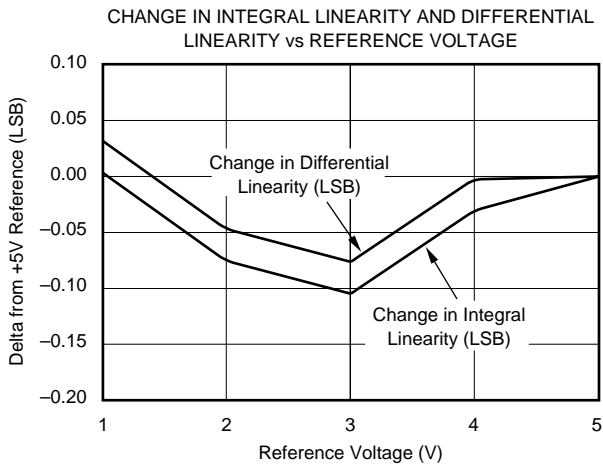
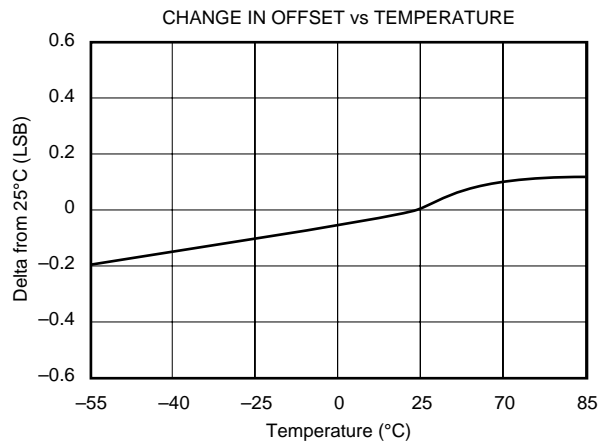
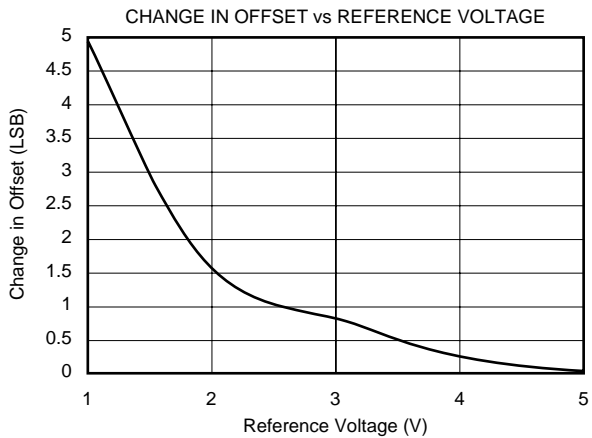
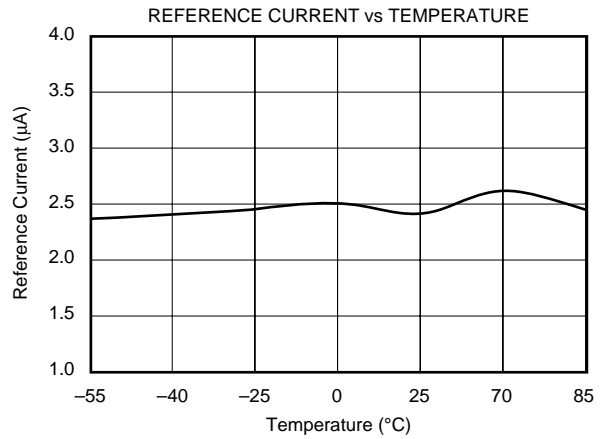
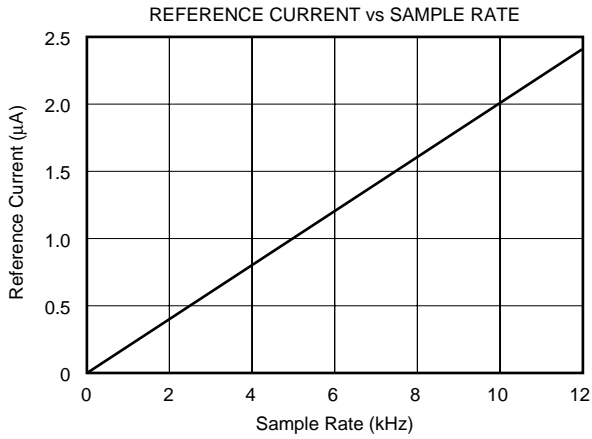

# TYPICAL PERFORMANCE CURVES (CONT)

At  $T_A = +25$ ,  $V_{CC} = +5V$ ,  $V_{REF} = +5V$ ,  $f_{SAMPLE} = 12.5kHz$ ,  $f_{CLK} = 16 \cdot f_{SAMPLE}$ , unless otherwise specified.

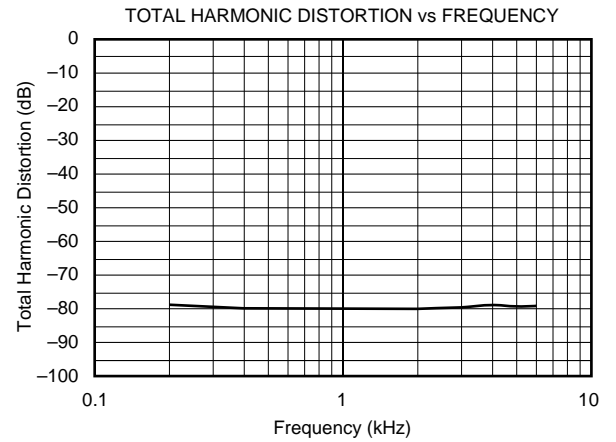
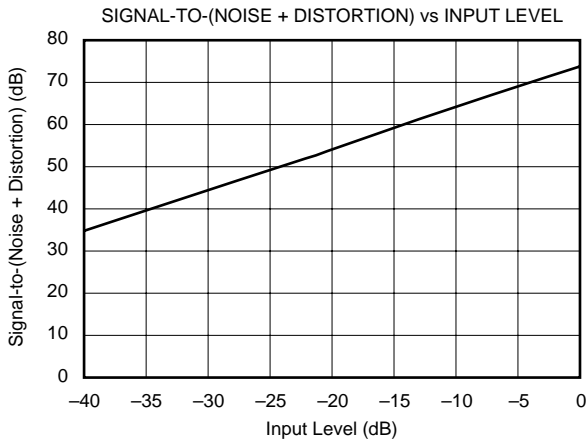
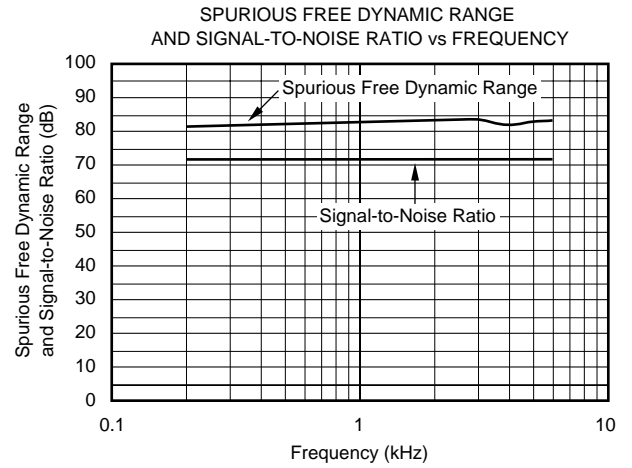
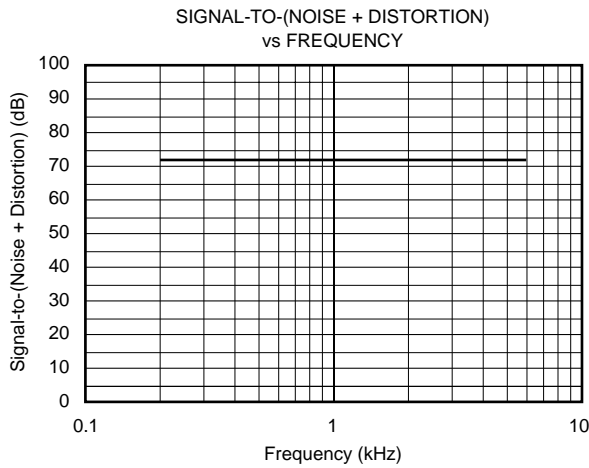
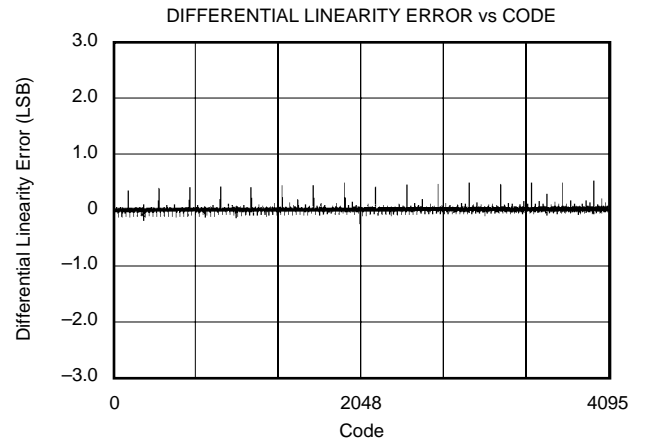
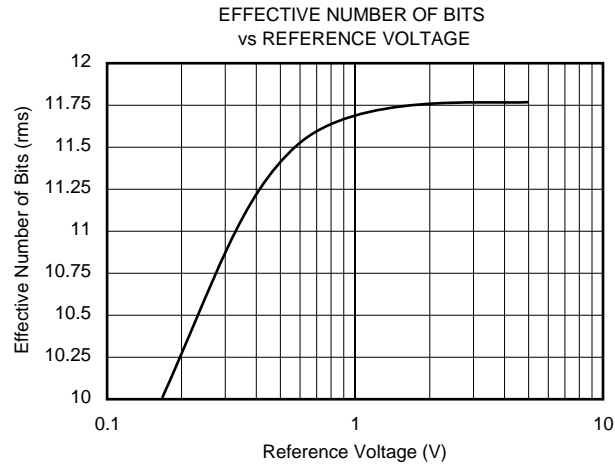

# TYPICAL PERFORMANCE CURVES (CONT)

At  $T_A = +25$ ,  $V_{CC} = +5V$ ,  $V_{REF} = +5V$ ,  $f_{SAMPLE} = 12.5kHz$ ,  $f_{CLK} = 16 \cdot f_{SAMPLE}$ , unless otherwise specified.

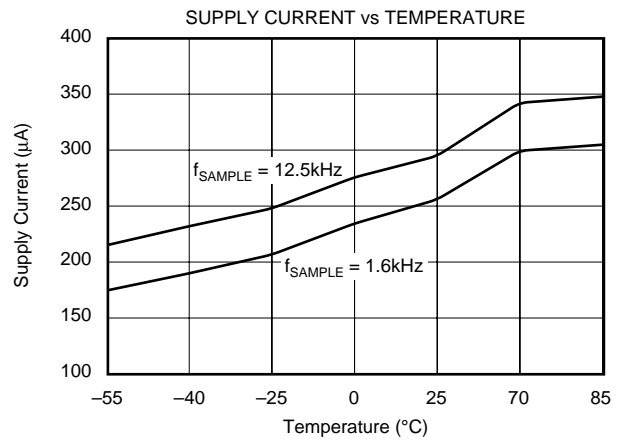
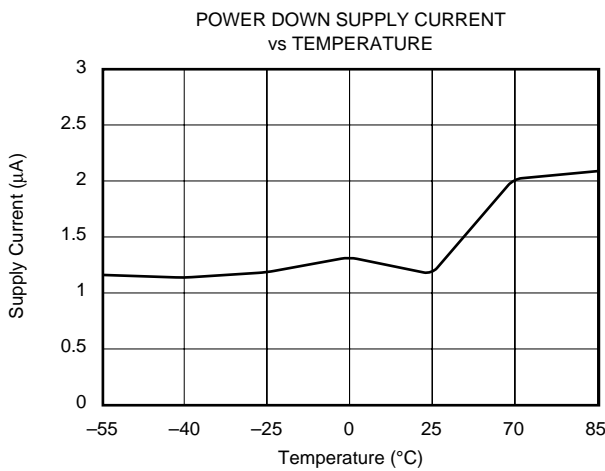
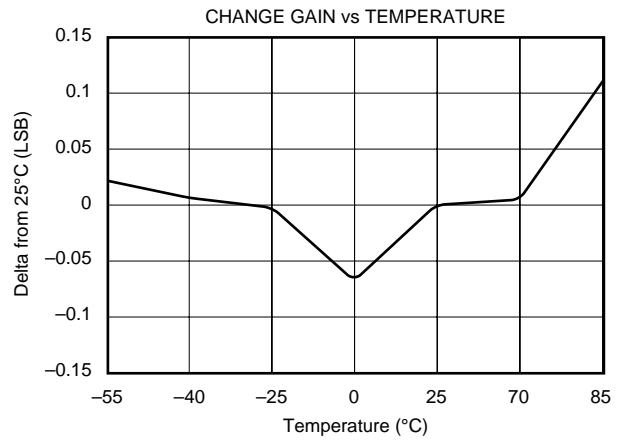
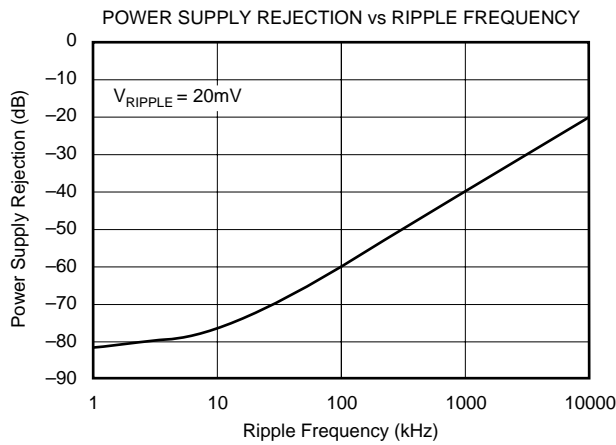
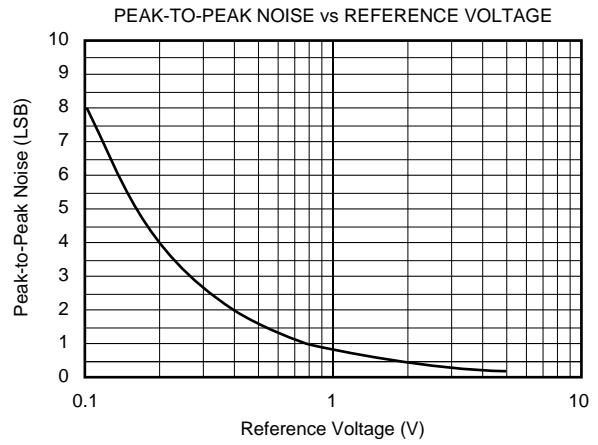
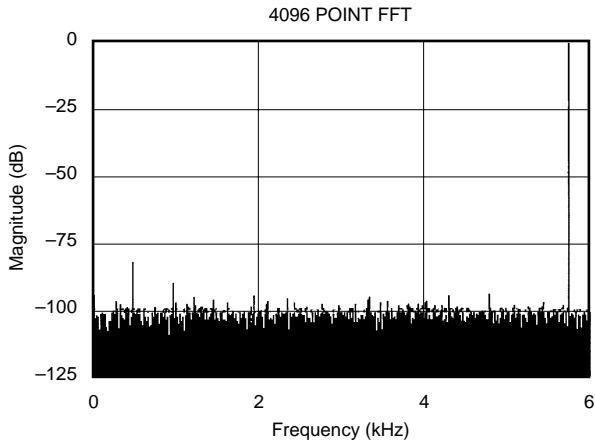

# TYPICAL PERFORMANCE CURVES (CONT)

At  $T_A = +25$ ,  $V_{CC} = +5V$ ,  $V_{REF} = +5V$ ,  $f_{SAMPLE} = 12.5kHz$ ,  $f_{CLK} = 16 \cdot f_{SAMPLE}$ , unless otherwise specified.

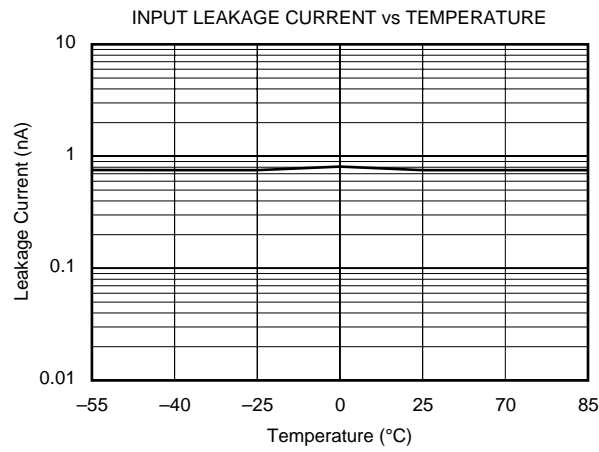
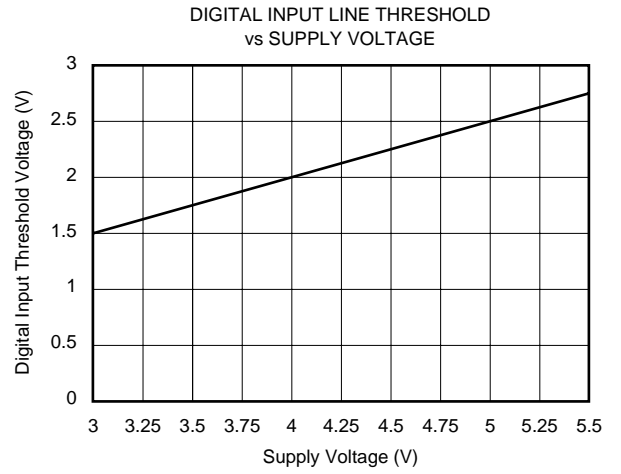
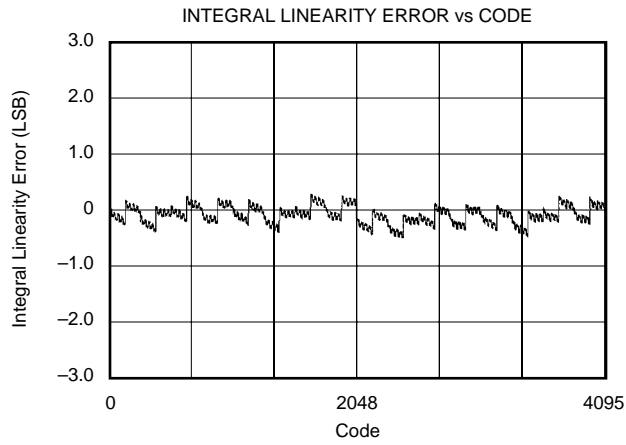

# TIMING DIAGRAMS AND TEST CIRCUITS

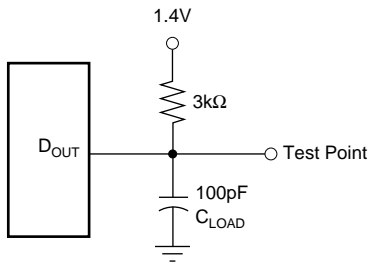

Load Circuit for  $t_{dDO}$ ,  $t_r$ , and  $t_f$

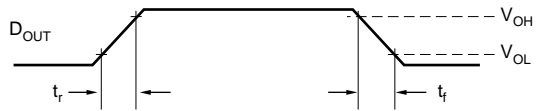

Voltage Waveforms for  $D_{OUT}$  Rise and Fall Times  $t_r$  and  $t_f$

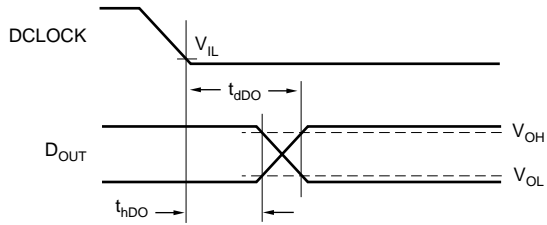

Voltage Waveforms for  $D_{OUT}$  Delay Times,  $t_{dDO}$

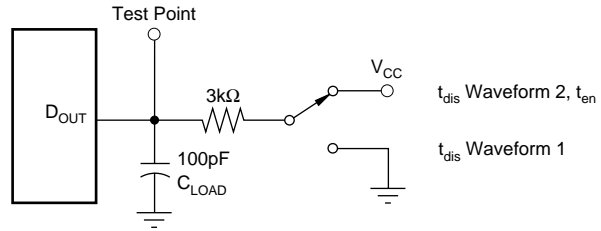

Load Circuit for  $t_{dis}$  and  $t_{den}$

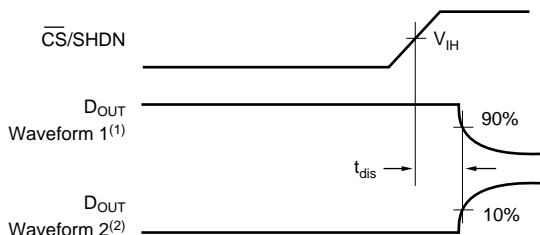

Voltage Waveforms for  $t_{dis}$

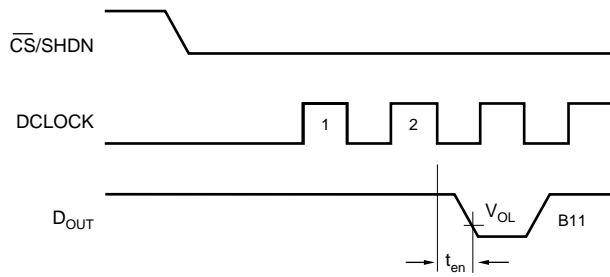

Voltage Waveforms for  $t_{en}$

NOTES: (1) Waveform 1 is for an output with internal conditions such that the output is HIGH unless disabled by the output control. (2) Waveform 2 is for an output with internal conditions such that the output is LOW unless disabled by the output control.



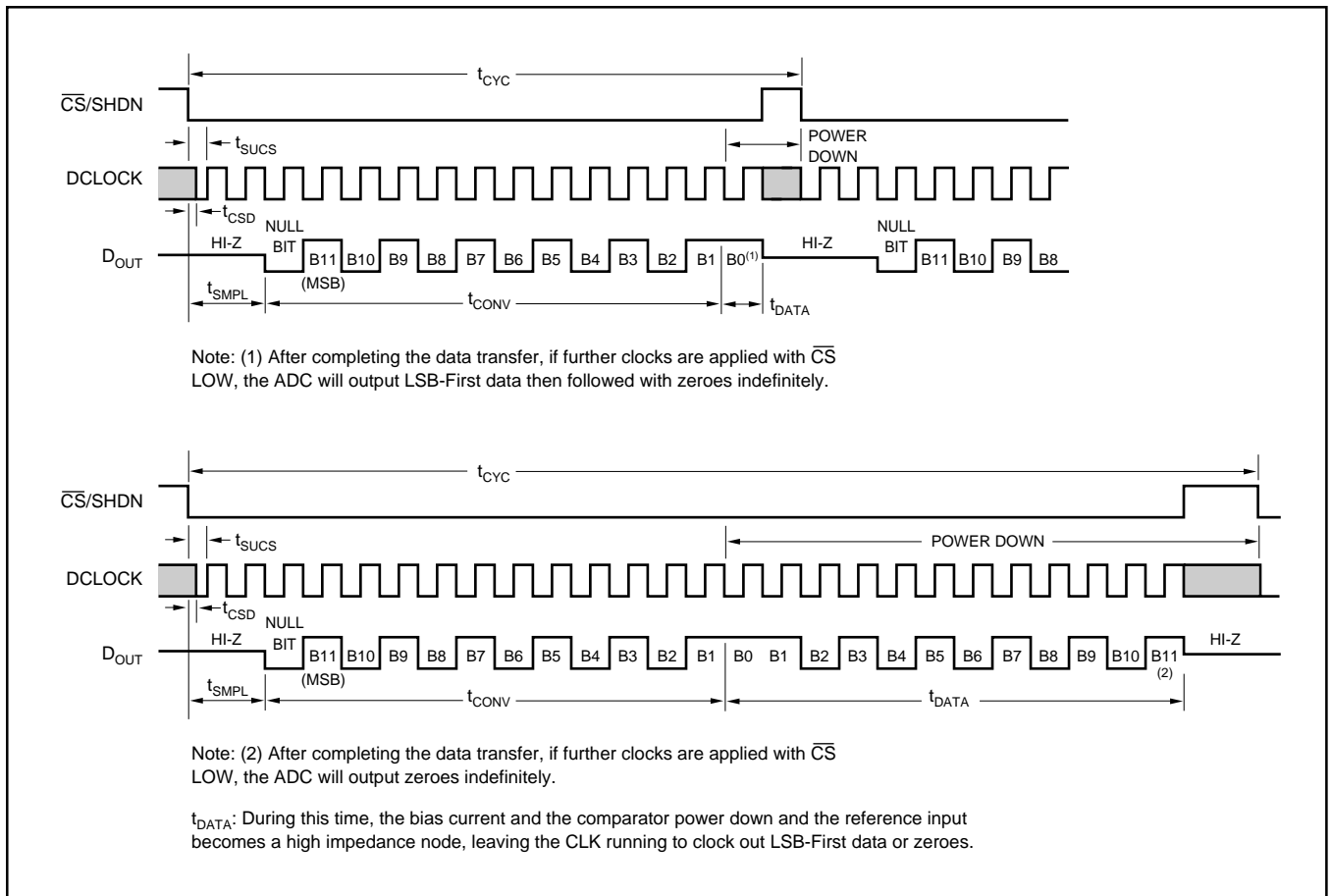

FIGURE 1. ADS1286 Operating Sequence.

## SERIAL INTERFACE

The ADS1286 communicates with microprocessors and other external digital systems via a synchronous 3-wire serial interface. DCLOCK synchronizes the data transfer with each bit being transmitted on the falling DCLOCK edge and captured on the rising DCLOCK edge in the receiving system. A falling  $\overline{CS}$  initiates data transfer as shown in Figure 1. After  $\overline{CS}$  falls, the second DCLOCK pulse enables  $D_{OUT}$ . After one null bit, the A/D conversion result is output on the  $D_{OUT}$  line. Bringing  $\overline{CS}$  high resets the ADS1286 for the next data exchange.

## MICROPOWER OPERATION

With typical operating currents of 250 $\mu$ A and automatic shutdown between conversions, the ADS1286 achieves extremely low power consumption over a wide range of sample rates (see Figure 2). The auto-shutdown allows the supply current to drop with sample rate.

### SHUTDOWN

The ADS1286 is equipped with automatic shutdown features. The device draws power when the  $\overline{CS}$  pin is LOW and shuts down completely when the pin is HIGH. The bias circuit and comparator powers down and the reference input becomes high impedance at the end of each conversion

leaving the DCLOCK running to clock out the LSB first data or zeroes. If the  $\overline{CS}$  input is not running rail-to-rail, the input logic buffer will draw current. This current may be large compared to the typical supply current. To obtain the lowest supply current, bring the  $\overline{CS}$  pin to ground when it is low and to supply voltage when it is high.

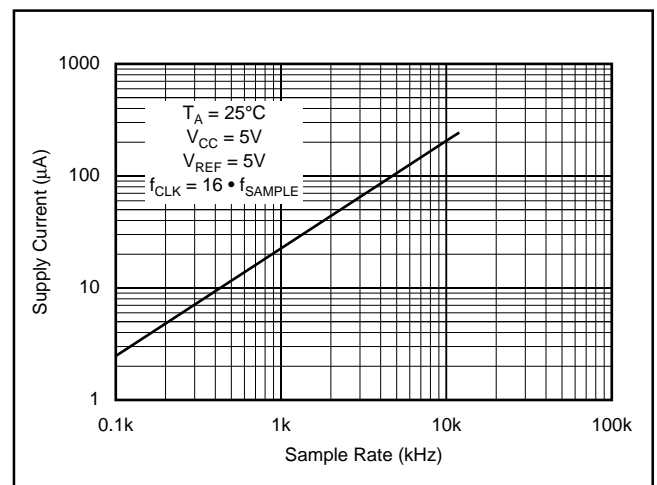

FIGURE 2. Automatic Power Shutdown Between Conversions Allows Power Consumption to Drop with Sample Rate.

## MINIMIZING POWER DISSIPATION

In systems that have significant time between conversions, the lowest power drain will occur with the minimum  $\overline{CS}$  LOW time. Bringing  $\overline{CS}$  LOW, transferring data as quickly as possible, and then bringing it back HIGH will result in the lowest current drain. This minimizes the amount of time the device draws power. After a conversion the A/D automatically shuts down even if  $\overline{CS}$  is held LOW. If the clock is left running to clock out LSB-data or zero, the logic will draw a small amount of current (see Figure 3).

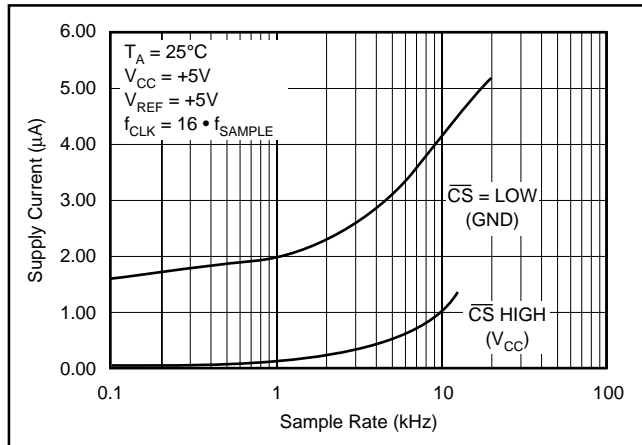

FIGURE 3. Shutdown Current with  $\overline{CS}$  HIGH is Lower than with  $\overline{CS}$  LOW.

## RC INPUT FILTERING

It is possible to filter the inputs with an RC network as shown in Figure 4. For large values of  $C_{\text{FILTER}}$  (e.g., 1 $\mu$ F), the capacitive input switching currents are averaged into a net DC current. Therefore, a filter should be chosen with a small resistor and large capacitor to prevent DC drops across the resistor. The magnitude of the DC current is approximately  $I_{\text{DC}} = 20\text{pF} \times V_{\text{IN}}/t_{\text{CYC}}$  and is roughly proportional to  $V_{\text{IN}}$ . When running at the minimum cycle time of 64 $\mu$ s, the input current equals 1.56 $\mu$ A at  $V_{\text{IN}} = 5\text{V}$ . In this case, a filter resistor of 75 $\Omega$  will cause 0.1LSB of full-scale error. If a larger filter resistor must be used, errors can be eliminated by increasing the cycle time.

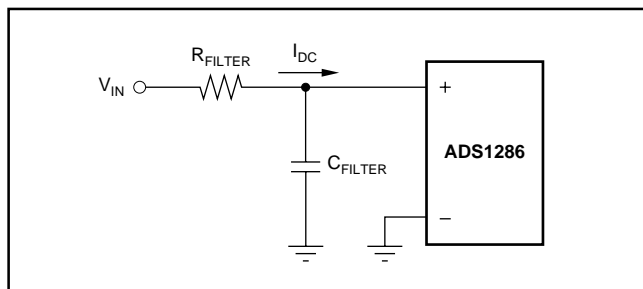

FIGURE 4. RC Input Filtering.

## REDUCED REFERENCE OPERATION

The effective resolution of the ADS1286 can be increased by reducing the input span of the converter. The ADS1286 exhibits good linearity and gain over a wide range of reference voltages (see Typical Performance Curves “Change in Linearity vs Reference Voltage” and “Change in Gain vs Reference Voltage”). However, care must be taken when operating at low values of  $V_{\text{REF}}$  because of the reduced LSB size and the resulting higher accuracy requirement placed on the converter. The following factors must be considered when operating at low  $V_{\text{REF}}$  values:

1. Offset
2. Noise

### OFFSET WITH REDUCED $V_{\text{REF}}$

The offset of the ADS1286 has a larger effect on the output code. When the ADC is operated with reduced reference voltage. The offset (which is typically a fixed voltage) becomes a larger fraction of an LSB as the size of the LSB is reduced. The Typical Performance Curve “Change in Offset vs Reference Voltage” shows how offset in LSBs is related to reference voltage for a typical value of  $V_{\text{OS}}$ . For example, a  $V_{\text{OS}}$  of 122 $\mu$ V which is 0.1 LSB with a 5V reference becomes 0.5LSB with a 1V reference and 2.5LSBs with a 0.2V reference. If this offset is unacceptable, it can be corrected digitally by the receiving system or by offsetting the negative input of the ADS1286.

### NOISE WITH REDUCED $V_{\text{REF}}$

The total input referred noise of the ADS1286 can be reduced to approximately 200 $\mu$ V peak-to-peak using a ground plane, good bypassing, good layout techniques and minimizing noise on the reference inputs. This noise is insignificant with a 5V reference but will become a larger fraction of an LSB as the size of the LSB is reduced.

For operation with a 5V reference, the 200 $\mu$ V noise is only 0.15LSB peak-to-peak. In this case, the ADS1286 noise will contribute virtually no uncertainty to the output code. However, for reduced references, the noise may become a significant fraction of an LSB and cause undesirable jitter in the output code. For example, with a 2.5V reference this same 200 $\mu$ V noise is 0.3LSB peak-to-peak. If the reference is further reduced to 1V, the 200 $\mu$ V noise becomes equal to 0.8LSBs and a stable code may be difficult to achieve. In this case averaging multiple readings may be necessary.

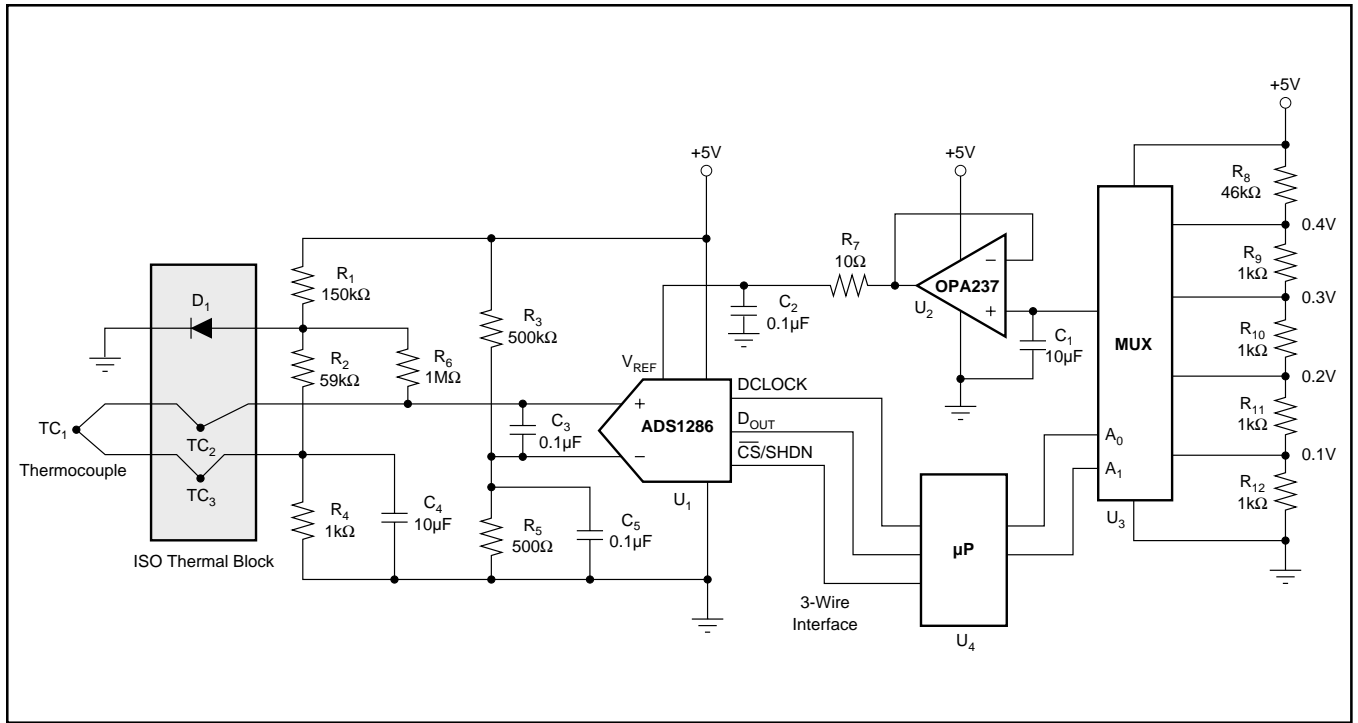

FIGURE 5. Thermocouple Application Using a MUX to Scale the Input Range of the ADS1286.

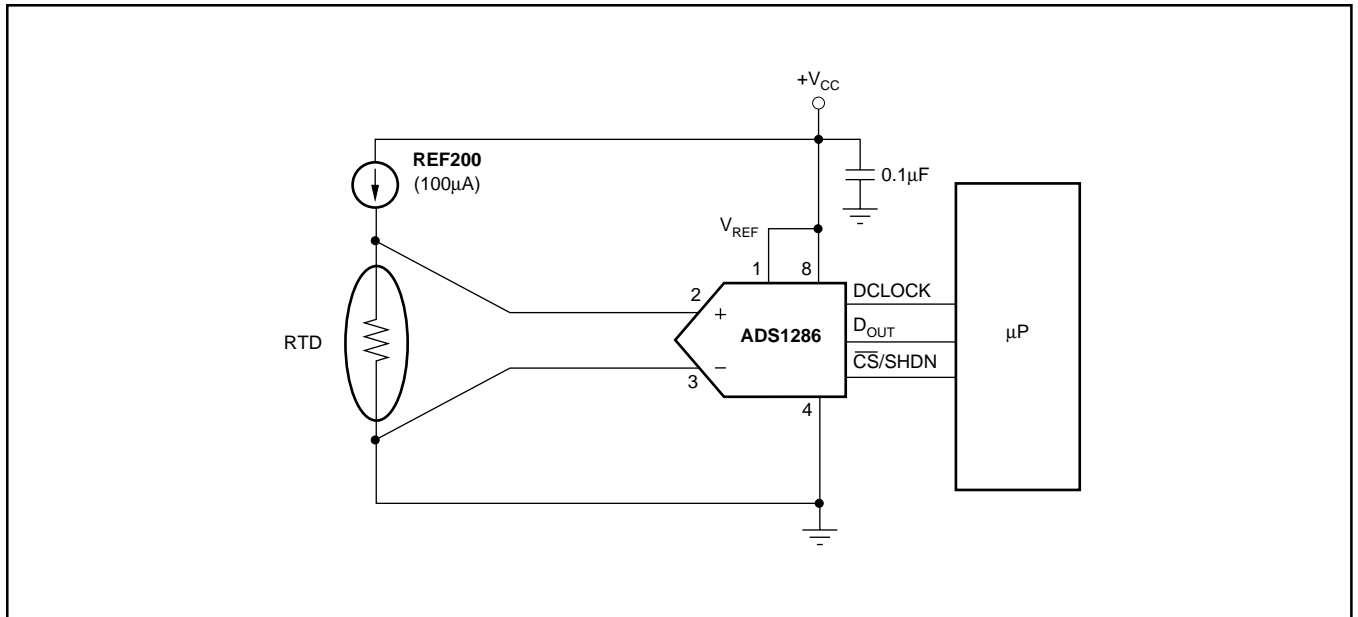

FIGURE 6. ADS1286 with RTD Sensor.

Компания «Океан Электроники» предлагает заключение долгосрочных отношений при поставках импортных электронных компонентов на взаимовыгодных условиях!

Наши преимущества:

- Поставка оригинальных импортных электронных компонентов напрямую с производств Америки, Европы и Азии, а так же с крупнейших складов мира;
- Широкая линейка поставок активных и пассивных импортных электронных компонентов (более 30 млн. наименований);
- Поставка сложных, дефицитных, либо снятых с производства позиций;
- Оперативные сроки поставки под заказ (от 5 рабочих дней);
- Экспресс доставка в любую точку России;
- Помощь Конструкторского Отдела и консультации квалифицированных инженеров;
- Техническая поддержка проекта, помощь в подборе аналогов, поставка прототипов;
- Поставка электронных компонентов под контролем ВП;
- Система менеджмента качества сертифицирована по Международному стандарту ISO 9001;
- При необходимости вся продукция военного и аэрокосмического назначения проходит испытания и сертификацию в лаборатории (по согласованию с заказчиком);
- Поставка специализированных компонентов военного и аэрокосмического уровня качества (Xilinx, Altera, Analog Devices, Intersil, Interpoint, Microsemi, Actel, Aeroflex, Peregrine, VPT, Syfer, Eurofarad, Texas Instruments, MS Kennedy, Miteq, Cobham, E2V, MA-COM, Hittite, Mini-Circuits, General Dynamics и др.);

Компания «Океан Электроники» является официальным дистрибьютором и эксклюзивным представителем в России одного из крупнейших производителей разъемов военного и аэрокосмического назначения «JONHON», а так же официальным дистрибьютором и эксклюзивным представителем в России производителя высокотехнологичных и надежных решений для передачи СВЧ сигналов «FORSTAR».



## JONHON

«JONHON» (основан в 1970 г.)

Разъемы специального, военного и аэрокосмического назначения:

(Применяются в военной, авиационной, аэрокосмической, морской, железнодорожной, горно- и нефтедобывающей отраслях промышленности)

«FORSTAR» (основан в 1998 г.)

ВЧ соединители, коаксиальные кабели, кабельные сборки и микроволновые компоненты:

(Применяются в телекоммуникациях гражданского и специального назначения, в средствах связи, РЛС, а так же военной, авиационной и аэрокосмической отраслях промышленности).



Телефон: 8 (812) 309-75-97 (многоканальный)

Факс: 8 (812) 320-03-32

Электронная почта: [ocean@oceanchips.ru](mailto:ocean@oceanchips.ru)

Web: <http://oceanchips.ru/>

Адрес: 198099, г. Санкт-Петербург, ул. Калинина, д. 2, корп. 4, лит. А