

Specification

Title: **FIXED THICK FILM CHIP RESISTORS;
RECTANGULAR TYPE AND ANTI SURGE**

Style: **RPC16, 20, 32, 35, 50, 63**

RoHS COMPLIANCE ITEM
Halogen and Antimony Free

Product specification contained in this specification
are subject to change at any time without notice
If you have any questions or a Purchasing Specification for any quality
Agreement is necessary, please contact our sales staff.



釜屋電機株式會社
KAMAYA ELECTRIC CO., LTD.

Hokkaido Research Center
Approval by: T. Sannomiya
Drawing by: M. Shibuya

Note: Stock conditions

Temperature: +5°C ~ +35°C

Relative humidity: 25% ~ 75%

The period of guarantee: Within 2 year from shipment by the company.
Solderability shall be satisfied.

1. Scope

1.1 This specification covers the detail requirements for fixed thick film chip resistors; rectangular type, style of RPC16, 20, 32, 35, 50, 63.

1.2 Applicable documents

- JIS C 5201-1: 1998, JIS C 5201-8: 1998, JIS C 5201-8-1: 1998
- IEC60115-1: 1999, IEC60115-8: 1989 Amendment 1: 1992, IEC60115-8-1: 1989
- EIAJ RC-2134B-2002

2. Classification

Type designation shall be the following form.



- 1 Fixed thick film chip resistors; rectangular type and high voltage Style
- 2 Size
- 3 Rated resistance Example; 475 → 4.7MΩ
- 4 Tolerance on rated resistance
- 5 Packaging form

3. Rating

3.1 The ratings shall be in accordance with Table-1.

Table-1

Style	Rated dissipation (W)	Temperature coefficient of resistance ($10^{-6} / ^\circ\text{C}$)	Rated resistance range(Ω)	Preferred number series for resistors	Tolerance on rated resistance
RPC16	0.25	±100	10~1M	E24	J(±5%)
		±200	1.0~9.1		
RPC20	0.25	±200	1.1M~22M	E24	J(±5%), K(±10%), M(±20%)
		±100	1.0~1M		
RPC32	0.33	±200	1.1M~22M	E24	J(±5%), K(±10%), M(±20%)
		±100	1.0~1M		
RPC35	0.5	±200	1.1M~22M	E24	J(±5%), K(±10%), M(±20%)
		±100	1.0~1M		
RPC50	0.75	±200	1.1M~22M	E24	J(±5%), K(±10%), M(±20%)
		±200	0.27~0.91		
RPC63	1.0	±200	1.1M~22M	E24	J(±5%), K(±10%), M(±20%)
		±100	1.0~1M		
		±200	0.27~0.91		

Style	Limiting element voltage (V)	Isolation voltage (V)	Category temperature range (°C)
RPC16	150	150	-55~+155
RPC20			
RPC32	200	500	
RPC35			
RPC50			
RPC63			

3.2 Climatic category

55/155/56

Lower category temperature - 55 °C
Upper category temperature +155 °C
Duration of the damp heat, steady state test 56days

3.3 Stability class

5%

Limits for change of resistance:
-for long-term tests ±(5%+0.1Ω)
-for short-term tests ±(1%+0.05Ω)

3.4 Derating

The derated values of dissipation at temperature in excess of 70 °C shall be as indicated by the following curve.

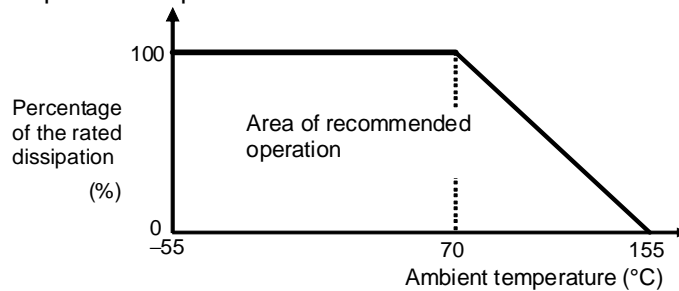

Figure-1 Derating curve

3.5 Rated voltage

d. c. or a. c. r. m. s. voltage calculated from the square root of the product of the rated resistance and the rated dissipation.

$$E = \sqrt{P \cdot R}$$

E : Rated voltage (V)
P : Rated dissipation (W)
R : Rated resistance (Ω)

Limiting element voltage can only be applied to resistors when the resistance value is equal to or higher than the critical resistance value.

At high value of resistance, the rated voltage may not be applicable.

4. Packaging form

The standard packaging form shall be in accordance with Table-2.

Table-2

Symbol	Packaging form		Standard packaging quantity / units	Application
B	Bulk (loose package)		1,000 pcs.	RPC16, 20, 32, 35, 50, 63
TP	Paper taping	8mm width, 4mm pitches	5,000 pcs.	RPC16, 20, 32
TE	Embossed taping	8mm width, 4mm pitches	4,000 pcs.	RPC35
		12mm width, 4mm pitches		RPC50, 63

5. Dimensions

5.1 The resistor shall be of the design and physical dimensions in accordance with Figure-2 and Table-3.



Figure-2

Table-3

Unit: mm

Style	L	W	H	c	d
RPC16	1.6±0.1	0.8 ^{+0.15} _{-0.05}	0.45±0.10	0.3±0.2	0.3±0.1
RPC20	2.0 ± 0.1	1.25 ± 0.10	0.55 ± 0.10	0.3 ± 0.2	0.4 ± 0.2
RPC32	3.1 ± 0.1	1.6 ± 0.15			0.5 ± 0.25
RPC35	3.1 ± 0.15	2.5 ± 0.15	0.55 ± 0.15	0.3 ± 0.15	0.6 ± 0.2
RPC50	5.0 ± 0.15	2.5 ± 0.15			
RPC63	6.3 ± 0.15	3.2 ± 0.15			

5.2 Net weight (Reference)

Style	Net weight(mg)
RPC16	2
RPC20	5
RPC32	9
RPC35	16
RPC50	25
RPC63	40

6. Marking

The Rated resistance shall be marked in 3 digits (E24) and marked on over coat side.

(Example)

“123” → 12 × 10³ [Ω] → 12 [kΩ]

“1R2” → 1.2 [Ω]

Table 4(2)

No	Test items	Condition of test (JIS C 5201-1)	Performance requirements
6	Mounting Bound strength of the end face plating Final measurements	Sub-clause 4.31 Substrate material: Epoxide woven glass Test substrate: Figure-4 Sub-clause 4.33 Bent value: 3 mm (3225 size max.) 1 mm (5025 size min.) Resistance Sub-clause 4.33.6 Visual examination	$\Delta R \leq \pm (1\%+0.05\Omega)$ No visible damage
7	Resistance to soldering heat Component resistance solvent	Sub-clause 4.18 Solder temperature: 260 °C ± 5 °C Immersion time: 10 s ± 0.5 s Visual examination Resistance Sub-clause 4.29 Solvent: 2-propanol Solvent temperature: 23 °C ± 5 °C Method 2 Recovery: 48 h Visual examination Resistance	As in 4.18.3.4 No sign of damage such as cracks. $\Delta R \leq \pm (1\%+0.05\Omega)$ No visible damage $\Delta R \leq \pm (1\%+0.05\Omega)$
8	Mounting Adhesion Rapid change temperature	Sub-clause 4.31 Substrate material: Epoxide woven glass Test substrate: Figure-3 Sub-clause 4.32 Force: 5 N Duration: 10 s ± 1 s Visual examination Sub-clause 4.19 Lower category temperature:-55 °C Upper category temperature:+155 °C Duration of exposure at each temperature: 30 min. Number of cycles: 5 cycles. Visual examination Resistance	No visible damage No visible damage $\Delta R \leq \pm (1\%+0.05\Omega)$

Table-4(3)

No	Test items	Condition of test (JIS C 5201-1)	Performance requirements
9	Climatic sequence -Dry heat -Damp heat, cycle (12+12hour cycle) First cycle -Cold -Damp heat, cycle (12+12hour cycle) Remaining cycle -D.C. load	Sub-clause 4.23 Sub-clause 4.23.2 Test temperature: +155 °C Duration: 16 h Sub-clause 4.23.3 Test method: 2 Test temperature: 55 °C [Severity(2)] Sub-clause 4.23.4 Test temperature -55 °C Duration: 2h Sub-clause 4.23.6 Test method: 2 Test temperature: 55 °C [Severity (2)] Number of cycles: 5 cycles Sub-clause 4.23.7 The applied voltage shall be the rated voltage or the limiting element voltage whichever is the smaller. Duration: 1 min. Visual examination Resistance	No visible damage $\Delta R \leq \pm (5\%+0.1\Omega)$
10	Mounting Endurance at 70 °C	Sub-clause 4.31 Substrate material: Epoxide woven glass (RPC63 may use Alumina substrate.) Test substrate: Figure-3 Sub-clause 4.25.1 Ambient temperature: 70 °C ± 2 °C Duration: 1000 h The voltage shall be applied in cycles of 1.5 h on and 0.5 h. The applied voltage shall be the rated voltage or the limiting element voltage whichever is the smaller. Examination at 48 h , 500 h and 1000 h: Visual examination Resistance	No visible damage $\Delta R \leq \pm (5\%+0.1\Omega)$

Table-4(4)

No	Test items	Condition of test (JIS C 5201-1)	Performance requirements
11	Mounting Variation of resistance with temperature	Sub-clause 4.31 Substrate material: Epoxide woven glass Test substrate: Figure-3 Sub-clause 4.8 -55 °C / +20 °C +20 °C / +155°C	As in Table-1
12	Mounting Damp heat, steady state	Sub-clause 4.31 Substrate material: Epoxide woven glass Test substrate: Figure-3 Sub-clause 4.24 Ambient temperature: 40 °C ± 2 °C Relative humidity : 93 \pm ₃ % a) 1st group: without voltage applied. b) 2nd group: The d. c. voltage shall be applied continuously. The voltage shall be accordance with Sub-clause 4.24.2.1 b). without polarizing voltage [4.24.2.1, c)] Visual examination Resistance	No visible damage Legible marking $\Delta R \leq \pm (5\%+0.1\Omega)$
13	Dimensions (detail) Mounting Endurance at upper category temperature	Sub-clause 4.4.3 Sub-clause 4.31 Substrate material: Epoxide woven glass Test substrate: Figure-3 Sub-clause 4.25.3 Ambient temperature:155 °C ± 2 °C Duration: 1000 h Examination at 48 h, 500 h and 1000 h: Visual examination Resistance	As in Table-3 No visible damage $\Delta R \leq \pm (5\%+0.1\Omega)$

8. Test substrate

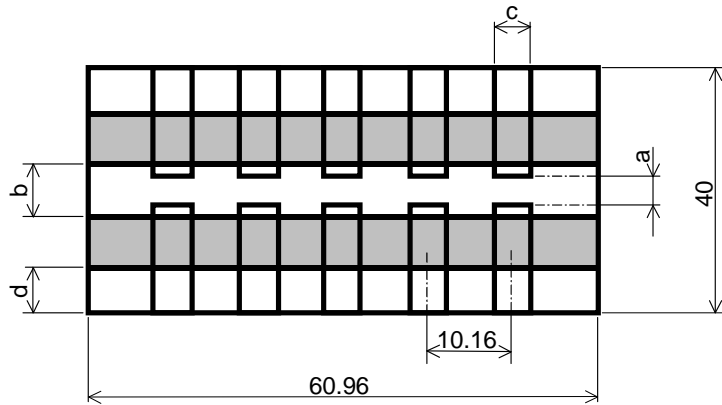

Unit: mm

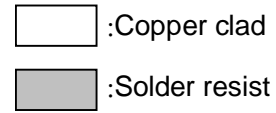

Style	a	b	c	d
RPC50	4.0	7.5	2.0	7.5
RPC63	5.0	9.0	4.5	7.5

RPC50, 63 TEST SUBSTRATE

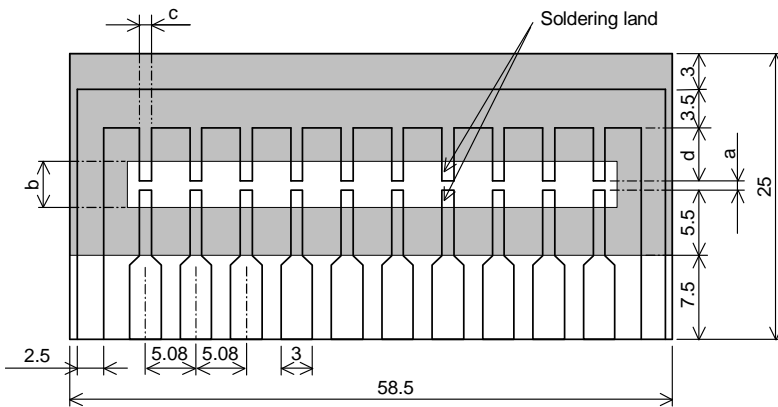

Unit: mm

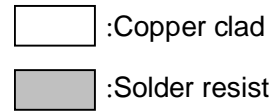

Style	a	b	c	d
RPC20	1.2	4.0	1.5	4.3
RPC35	2.2	5.0	2.9	3.3

RPC20, 35 TEST SUBSTRATE



Unit: mm

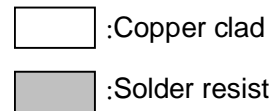

RPC32 TEST SUBSTRATE



RPC16 TEST SUBSTRATE

Figure-3

- Remark 1). Material: Epoxide woven glass
 Thickness: 1.6mm Thickness of copper clad: 0.035mm
- 2). In the case of connection by connector, the connecting terminals are gold plated.
 However, the plating is not necessary when the connection is made by soldering.



RPC50, 63 BOUND STRENGTH OF THE END FACE PLATING TEST SUBSTRATE



Unit: mm

□ :Copper clad
 ■ :Solder resist

Style	a	b	c	d
RPC16	1.0	3.6	1.2	3.0
RPC20	1.2	4.0	1.65	3.0
RPC32	2.5	5.0	2.0	2.5
RPC35	2.2	5.0	2.9	2.5

Remark 1). Material: Epoxide woven glass

Thickness: 1.6mm Thickness of copper clad: 0.035mm

RPC16,20,32,35 BOUND STRENGTH OF THE END FACE PLATING TEST SUBSTRATE

Figure-4

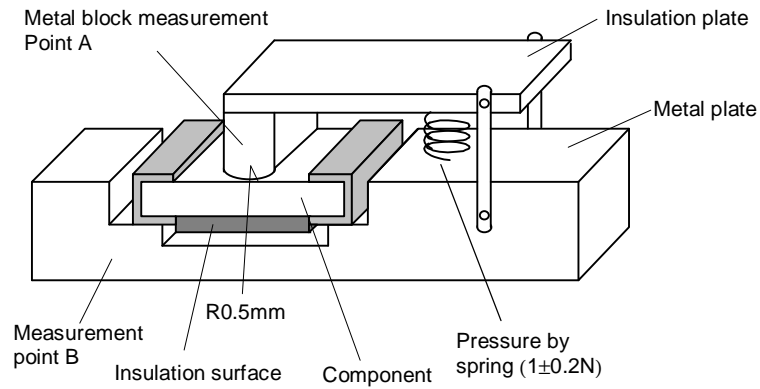

Figure-5

9. Taping

9.1 Applicable documents JIS C 0806-3: 1999, EIAJ ET-7200B: 2003

9.2 Taping dimensions

9.2.1 Paper taping (8mm width, 4mm pitches)

Taping dimensions shall be in accordance with Figure-6 and Table-5.



Figure-6

Table-5

Unit: mm

Style	A	B	t ₁	t ₂
RPC16	1.15±0.15	1.9±0.2	0.6±0.1	0.8max.
RPC20	1.65±0.15	2.5±0.2	0.8±0.1	1.0max.
RPC32	2.00±0.15	3.6±0.2		

9.2.2 Embossed taping dimensions shall be in accordance with Figure-7 and Table-6.



Figure-7

Table-6

Unit: mm

Style	A	B	W	E	t ₁
RPC35	2.85±0.2	3.5±0.2	8.0±0.3	3.5±0.05	1.0±0.2
RPC50	3.1±0.2	5.5±0.2	12.0±0.3	5.5±0.05	1.1±0.15
RPC63	3.6±0.2	6.9±0.2			

- 1). The cover tapes shall not cover the sprocket holes.
- 2). Tapes in adjacent layers shall not stick together in the packing.
- 3). Components shall not stick to the carrier tape or to the cover tape.
- 4). Pitch tolerance over any 10 pitches $\pm 0.2\text{mm}$.
- 5). The peel strength of the top cover tape shall be with in 0.1N to 0.5N on the test method as shown in the following
 RPC16, 20, 32: Figure-8, RPC35, 50, 63: Figure-9.
- 6). When the tape is bent with the minimum radius for RPC16, 20, 32, 35: 25 mm, or RPC50, 63: 30 mm, the tape shall not be damaged and the components shall maintain their position and orientation in the tape.
- 7). In no case shall there be two or more consecutive components missing.
 The maximum number of missing components shall be one or 0.1%, whichever is greater.
- 8). The resistors shall be faced to upward at the over coating side in the carrier cavity.

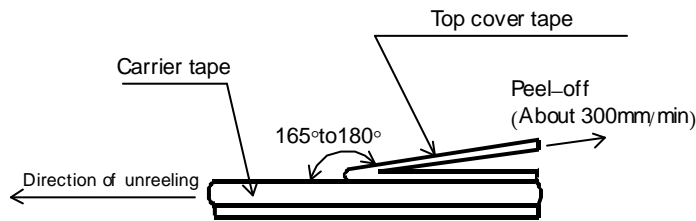

Figure-8



Figure-9

9.3 Reel dimension

Reel dimensions shall be in accordance with the following Figure-10 and Table-7.

Plastic reel (Based on EIAJ ET-7200B)



Figure-10

Table-7

Unit: mm

Style	A	B	Note
RPC16,20,32,35	9 ^{+1.0} / ₀	11.4±1.0	Injection molding
		13±1.0	Vacuum forming
RPC50,63	13 ^{+1.0} / ₀	17±1.0	Vacuum forming

Note: Marking label shall be marked on a place of Marking A or two place of Marking A and B.

9.4 Leader and trailer tape.



Figure-11

10. Marking on package

The label of a minimum package shall be legibly marked with follows.

10.1 Marking A

- (1) Classification (Style, Rated resistance, Tolerance on rated resistance, Packaging form)
- (2) Quantity (3) Lot number (4) Manufacturer's name or trade mark (5) Others

10.2 Marking B (KAMAYA Control label)

Mouser Electronics

Authorized Distributor

Click to View Pricing, Inventory, Delivery & Lifecycle Information:

Walsin:

[RPC32100MTP](#) [RPC504R7KTE](#) [RPC20182MTP](#) [RPC63471KTE](#) [RPC35150MTE](#) [RPC35275MTE](#) [RPC321R1MTP](#)
[RPC20122KTP](#) [RPC205R1JTP](#) [RPC35104JTE](#) [RPC20152JTP](#) [RPC63101KTE](#) [RPC202R7MTP](#) [RPC20330JTP](#)
[RPC20182JTP](#) [RPC35113MTE](#) [RPC50111JTE](#) [RPC63221KTE](#) [RPC35303JTE](#) [RPC32102JTP](#) [RPC63470KTE](#)
[RPC35200JTE](#) [RPC20161MTP](#) [RPC50331MTE](#) [RPC50270JTE](#) [RPC35244MTE](#) [RPC32104JTP](#) [RPC35820JTE](#)
[RPC20153KTP](#) [RPC35150JTE](#) [RPC35305MTE](#) [RPC63470JTE](#) [RPC50511MTE](#) [RPC20100JTP](#) [RPC63390KTE](#)
[RPC32220KTP](#) [RPC35135JTE](#) [RPC35120JTE](#) [RPC63183JTE](#) [RPC63101JTE](#) [RPC20102KTP](#) [RPC20751MTP](#)
[RPC35100JTE](#) [RPC32332JTP](#) [RPC63100JTE](#) [RPC35115MTE](#) [RPC50100KTE](#) [RPC32104MTP](#) [RPC321R0JTP](#)
[RPC503R0JTE](#) [RPC63181JTE](#) [RPC32435JTP](#) [RPC32755MTP](#) [RPC35244JTE](#) [RPC35303MTE](#) [RPC503R3JTE](#)
[RPC20334JTP](#) [RPC632R2JTE](#) [RPC63106JTE](#) [RPC50123JTE](#) [RPC50152KTE](#) [RPC32102KTP](#) [RPC20200JTP](#)
[RPC20680JTP](#) [RPC32471JTP](#) [RPC32910JTP](#) [RPC32100JTP](#) [RPC50511KTE](#) [RPC20105JTP](#) [RPC50102KTE](#)
[RPC63-270KTE](#) [RPC20102JTP](#) [RPC201R0KTP](#) [RPC202R2JTP](#)

Компания «Океан Электроники» предлагает заключение долгосрочных отношений при поставках импортных электронных компонентов на взаимовыгодных условиях!

Наши преимущества:

- Поставка оригинальных импортных электронных компонентов напрямую с производств Америки, Европы и Азии, а так же с крупнейших складов мира;
- Широкая линейка поставок активных и пассивных импортных электронных компонентов (более 30 млн. наименований);
- Поставка сложных, дефицитных, либо снятых с производства позиций;
- Оперативные сроки поставки под заказ (от 5 рабочих дней);
- Экспресс доставка в любую точку России;
- Помощь Конструкторского Отдела и консультации квалифицированных инженеров;
- Техническая поддержка проекта, помощь в подборе аналогов, поставка прототипов;
- Поставка электронных компонентов под контролем ВП;
- Система менеджмента качества сертифицирована по Международному стандарту ISO 9001;
- При необходимости вся продукция военного и аэрокосмического назначения проходит испытания и сертификацию в лаборатории (по согласованию с заказчиком);
- Поставка специализированных компонентов военного и аэрокосмического уровня качества (Xilinx, Altera, Analog Devices, Intersil, Interpoint, Microsemi, Actel, Aeroflex, Peregrine, VPT, Syfer, Eurofarad, Texas Instruments, MS Kennedy, Miteq, Cobham, E2V, MA-COM, Hittite, Mini-Circuits, General Dynamics и др.);

Компания «Океан Электроники» является официальным дистрибьютором и эксклюзивным представителем в России одного из крупнейших производителей разъемов военного и аэрокосмического назначения «JONHON», а так же официальным дистрибьютором и эксклюзивным представителем в России производителя высокотехнологичных и надежных решений для передачи СВЧ сигналов «FORSTAR».



JONHON

«JONHON» (основан в 1970 г.)

Разъемы специального, военного и аэрокосмического назначения:

(Применяются в военной, авиационной, аэрокосмической, морской, железнодорожной, горно- и нефтедобывающей отраслях промышленности)

«FORSTAR» (основан в 1998 г.)

ВЧ соединители, коаксиальные кабели, кабельные сборки и микроволновые компоненты:

(Применяются в телекоммуникациях гражданского и специального назначения, в средствах связи, РЛС, а так же военной, авиационной и аэрокосмической отраслях промышленности).



Телефон: 8 (812) 309-75-97 (многоканальный)

Факс: 8 (812) 320-03-32

Электронная почта: ocean@oceanchips.ru

Web: <http://oceanchips.ru/>

Адрес: 198099, г. Санкт-Петербург, ул. Калинина, д. 2, корп. 4, лит. А