

MAX77752 Evaluation Kit

Evaluates: MAX77752

General Description

The MAX77752 evaluation kit (EV kit) is a fully assembled and tested printed circuit board (PCB) that demonstrates the highly integrated MAX77752 PMIC. The MAX77752 comprises three buck converters, a low dropout linear regulator, two external regulators enable outputs, two dedicated load switch controllers, and an inrush-current limiter which can be configured as a third load switch controller using OTP.

The EV kit also includes a MAXQ2000 microcontroller command module that provides the I²C interface to control power sequence, inrush current, individual output on/off, and setting regulator output voltage.

The MAX77752 evaluation software is provided for easy evaluation.

Benefits and Features

- USB to I²C Converter Allows for Easy Communication
- Level Translator (MAX3395) Allows for Adjusting I²C Bus Voltage from 1.8V to 3.3V
- On-Board Electronics Load Allows for Easy Evaluation
 - GUI Allows Static/Dynamic Load Adjustment for Buck Converters, LDO, LSWs, and SYS
 - MOSFET can be Driven by External Function Generator to Evaluate Transient Performance for Each Regulator
- Proven PCB Reference Design and Layout
- Fully Assembled and Tested

Ordering Information appears at end of data sheet.

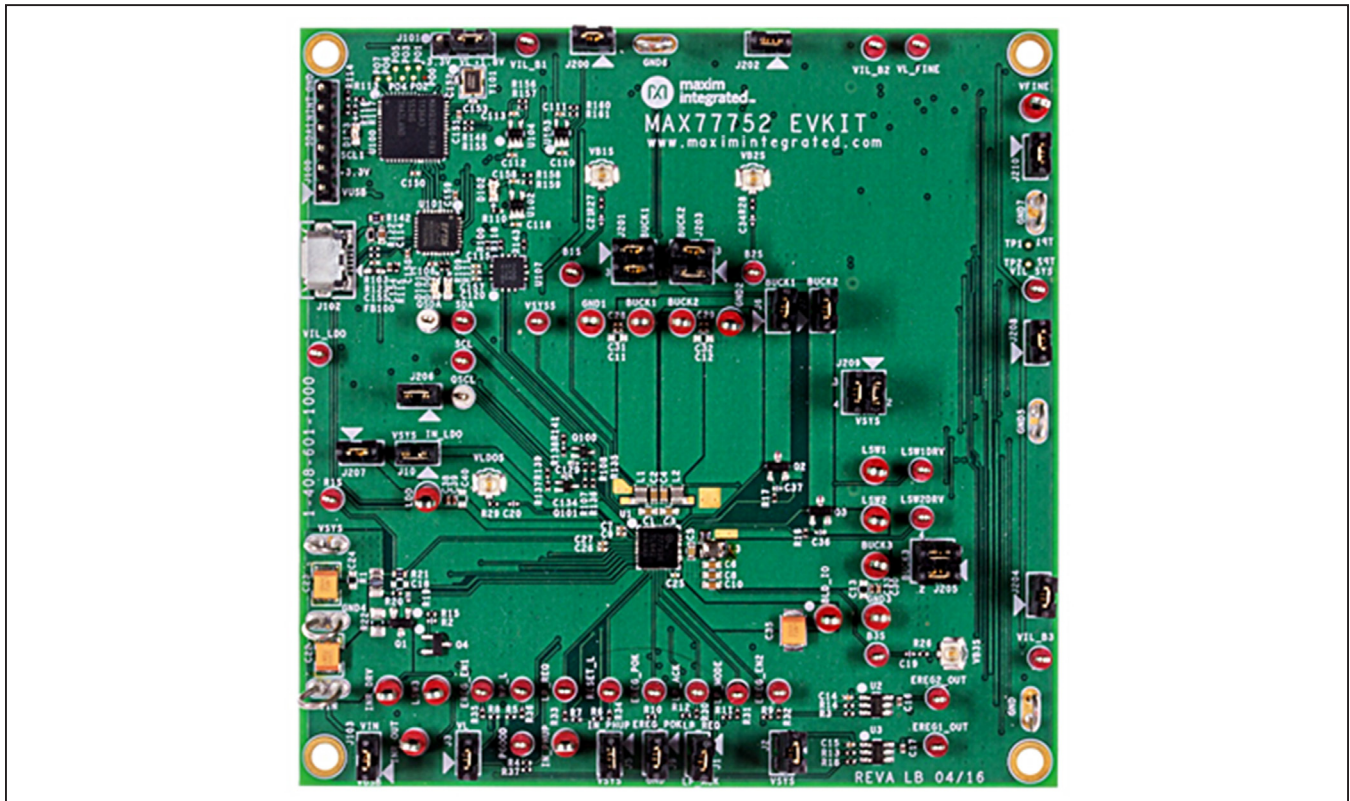

Figure 1. MAX77752 EV Kit Photo

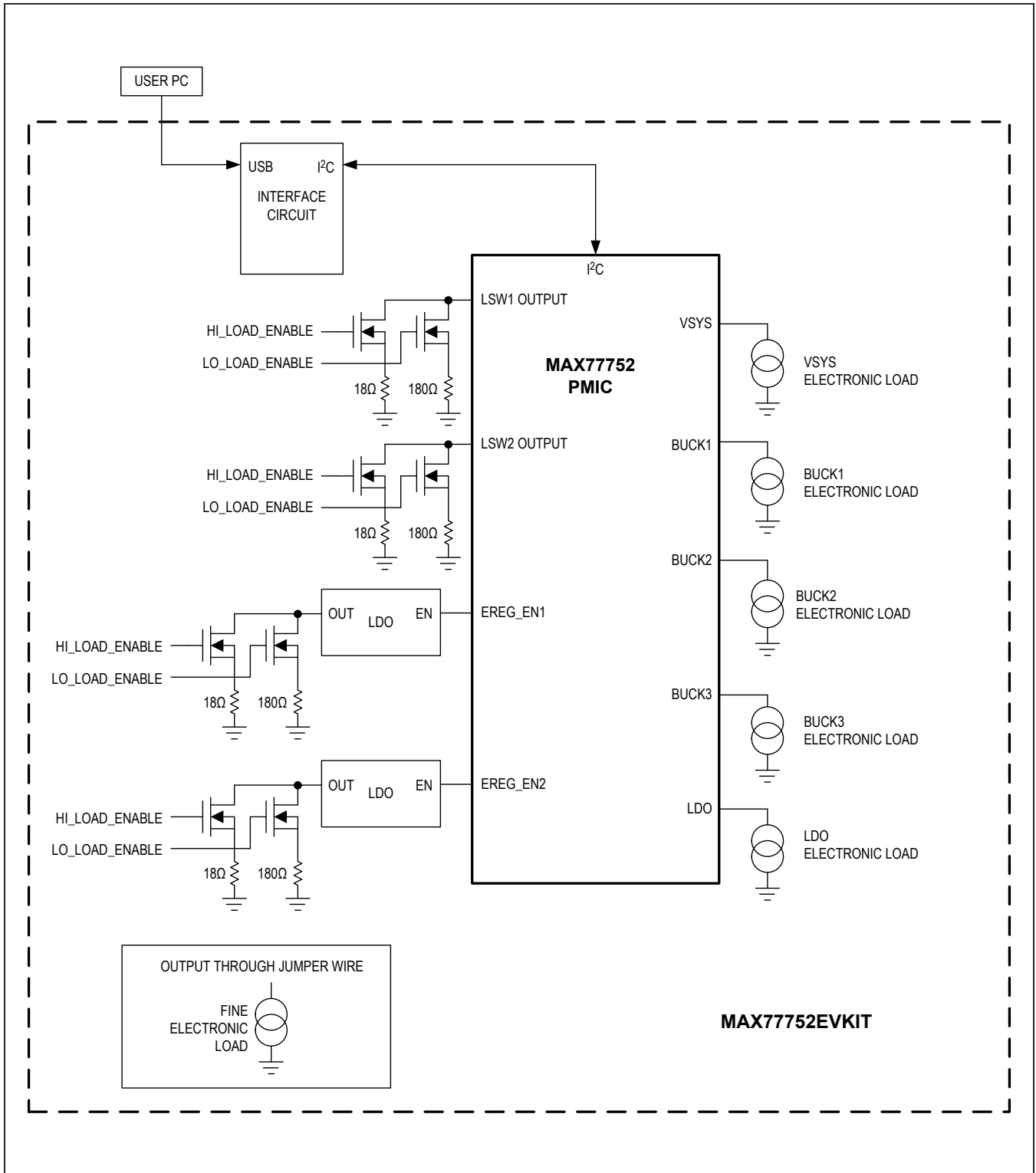

Figure 2. MAX77752 EV Kit Block Diagram

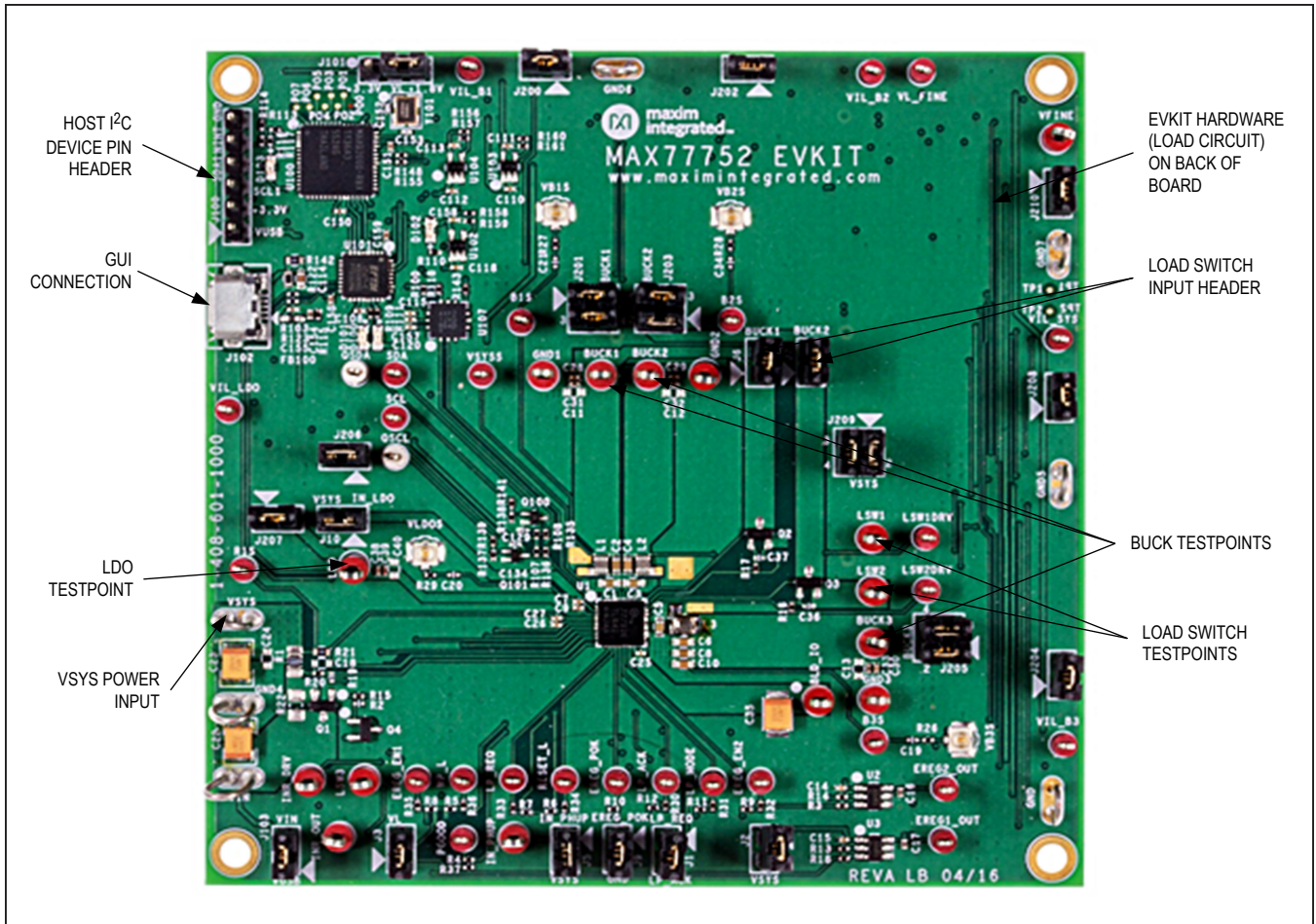

Figure 3: MAX77752 EV Kit Top View

Table 1. Default Shunt Positions and Jumper Descriptions

REFERENCE DESIGNATOR	DEFAULT POSITION	FUNCTION
J1	OPEN	1-2: Connects LP_REQ to LP_MODE.
J2	OPEN	1-2: Connects VSYS to external regulators.
J3	OPEN	1-2: Connects VL to GPIO expander pullup resistors.
J4	2-3	1-2: Connects LP_MODE to VSYS. 2-3: Connects LP_MODE to GND.
J5	OPEN	1-2: Connects IN_PHUP to VSYS.
J6	OPEN	1-2: Connects VBUCK1 to Drain of LSW1 MOSFET.
J7	OPEN	1-2: Connects VBUCK2 to drain of LSW2 MOSFET.
J9	OPEN	1-2: Connects EREG_POK to GND.
J10	1-2	1-2: Connects VSYS to IN_LDO.
J101	2-3	1-2: Connects 3.3V to VL. 2-3: Connects 1.8V to VL.
J103	OPEN	1-2: Connects VIN to VUSB.
J200	1-2	1-2, 3-4: Connects the U200 amplifier to the gate of the Q200 load FET.
J208	1-2	1-2, 3-4: Connects the U204 amplifier to the gate of the Q204 load FET.
J209	1-2, 3-4	1-2, 3-4: Connects SYS to drain of the Q204 FET.
JU201	1-2, 3-4	1-2, 3-4: Connects VBUCK1 to drain of Q200 load FET.
JU202	1-2	1-2: Connects the U201 amplifier to the gate of the Q201 load FET.
JU203	1-2, 3-4	1-2, 3-4: Connects VBUCK2 to drain of Q201 load FET.
JU204	1-2	1-2: Connects the U202 amplifier to the gate of the Q202 load FET.
JU205	1-2, 3-4	1-2, 3-4: Connects VBUCK3 to drain of Q202 load FET.
JU206	1-2	1-2: Connects the U203 amplifier to the gate of the Q203 load FET.
JU207	1-2	1-2: Connects VLDO to drain of Q203 load FET.

Table 2. Default Voltages (CID4 = 0x07)

REGULATOR	EXPECTED VOLTAGE (V) (OPTION1)
BUCK1	1.8
BUCK2	1.35
BUCK3	1.05
LDO	1.8
LSW1	1.35
LSW2	OFF

Quick Start

Follow this procedure to familiarize yourself with the EV kit.

Note: In the following sections, software-related items are identified by bolding. Text in **bold** refers to items directly from the EV kit software. Text in **bold and underlined** refers to items from the Windows operating system.

Required Equipment

- MAX77752 EV kit
- Windows®-based PC
- Power supply
- Ammeter
- DVM
- Micro-USB cable
- GUI

Procedure

The EV kit is fully assembled and tested. Follow the steps below to verify board operation:

- 1) Install all shunts as recommended in [Table 1](#).
- 2) Connect a disabled 5.0V bench power supply through an ammeter to VIN and GND wire loops. Set the input current limit of the bench supply to 3A. Do not enable the output of the bench supply until prompted.
- 3) Using a jumper wire, connect LSW1 to BUCK2.
- 4) Enable the output of the 5V and 1.8V bench power supply. Quiescent current of the 5V supply should be approximately 370µA (300µA with USB connected).
- 5) Connect a Micro-B USB cable between the EV kit and the PC.
- 6) Wait a few seconds for your computer to install the USB driver. Once the driver is successfully installed, a Window’s pop-up message shows that the “USB Serial Converter” is ready to use.
- 7) Open the MAX77752 GUI.
- 8) In the upper left corner of the GUI, select **Device**. Connect as shown in [Figure 4](#). Once connected, a pop-up window is shown (see [Figure 5](#)). Click on the **Read and close** button.
- 9) Check the LDO, BUCK1 and BUCK2 regulators, and LSW are on by measuring their output (see [Table 2](#).)

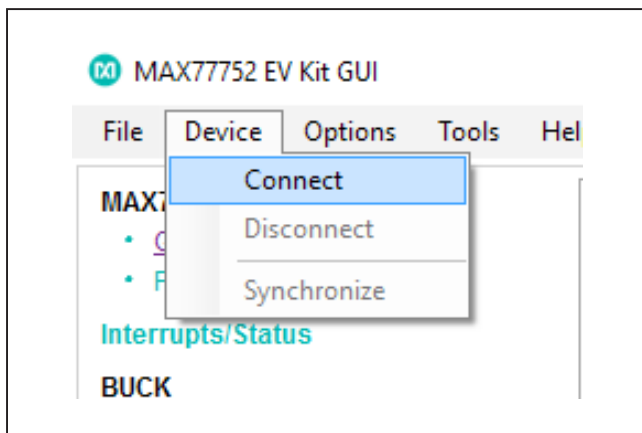

Figure 4. Quick Start: Regulator Check with the ADC

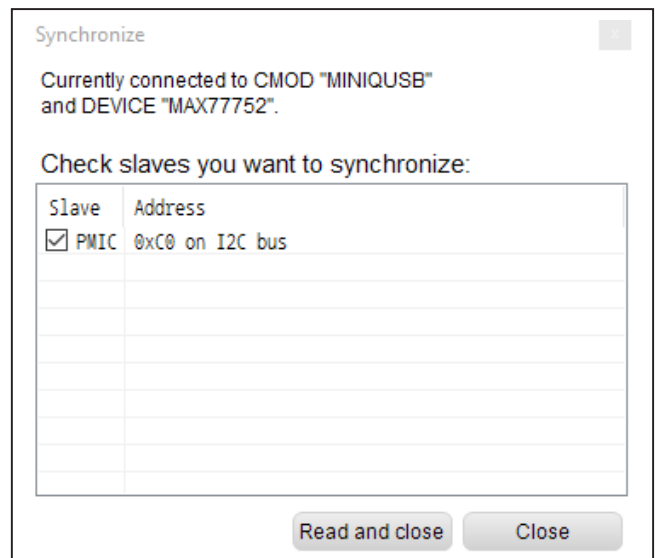

Figure 5. Connecting to the MAX77752 PMIC

Windows is a registered trademark and registered service mark of Microsoft Corporation.

EV Kit Features

Electronic Load

The EV kit comes with six electronic loads that allow the user to easily evaluate each regulator simultaneously. An on-board DAC and op-amp configuration sets the load current through I²C via the MAX77752 GUI.

The EV kit also includes resistive loads (18Ω and 180Ω) for the load switches and two external LDO regulators (see Figure 7). This is done by sending a high signal from the GPIO expander to drive the gate of the MOSFET which allows current to flow through the load resistor.

INRUSH/LSW3 Configuration

When configuring either INRUSH or LSW3, follow the configurations as shown in Table 3.

Software

The graphical user interface (GUI) software allows for quick, easy, and thorough evaluation of the MAX77752. The GUI is designed to have individual tabs for each functional block of the device (Global Resources, Interrupts/Status, LDO, and Load Switches) and one additional tab for controlling EV kit hardware (Load Control).

Installation

Visit www.maximintegrated.com/evkitsoftware to download the latest version of the EV kit software. Save the EV kit software to a temporary folder and unzip the ZIP file.

Windows Drivers

Upon connection of a Micro-USB cable between your PC and the EV kit for the first time, wait a few minutes for Windows to automatically install the necessary drivers.

Graphical User Interface (GUI) Details

The GUI drives I²C communication with the EVKIT. Every control in the GUI (excluding the Load Control) corresponds directly to a register within the MAX77752. Refer to the register map in the device data sheet for a complete description of the registers. The **Load Control** tab provides additional functionality with the EV kit.

Load Control Tab

The **Load Control** tab contains controls for setting load on the regulators' output. The GUI is capable of setting steady-state, transient, and random load currents. To set a load current, use the slider bar or text field to input a value (mA) and press the **Enable** button. Shuffle through the modes to exercise different load conditions. The offset and gain values are set by Maxim and do not need to be altered.

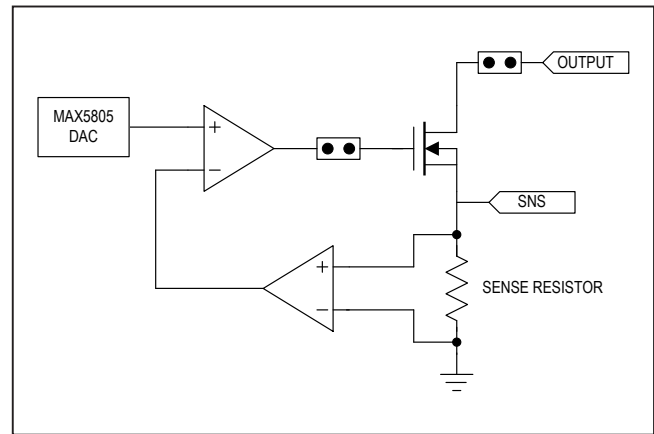

Figure 6. Electronic Load Block Diagram

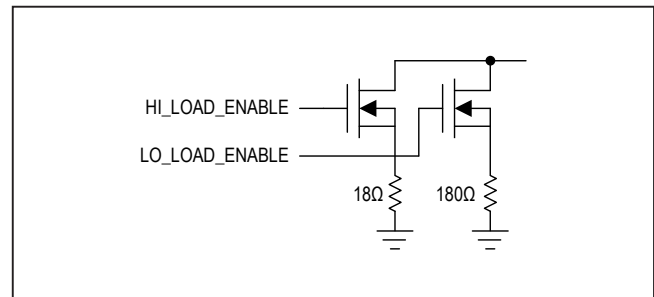

Figure 7. Electronic Load Block Diagram

Table 3. INRUSH and LSW3 Configuration

DESIGNATOR	INRUSH	LSW3
R2	DNI	0Ω
R15	0Ω	DNI
R19	DNI	0Ω
R20	0Ω	DNI
R22	DNI	0Ω (CRCW08050000Z0EAHP)

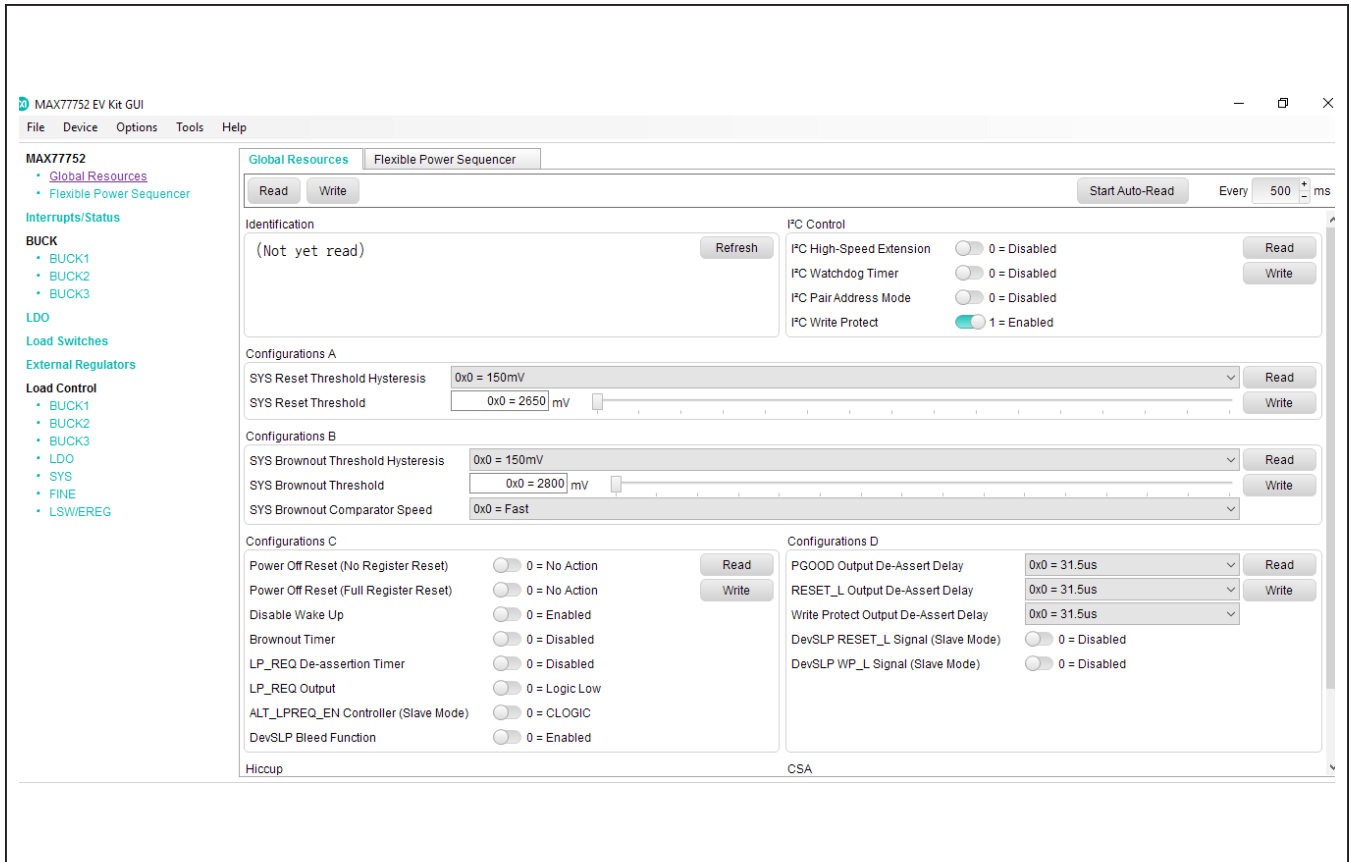

Figure 8. MAX77752 EV Kit GUI Top-Level Interface

MAX77752 EV Kit Bill of Materials

REF DES	DNI/DNP	QTY	MFG PART #	MANUFACTURER	VALUE	DESCRIPTION
B15-B35, R15, SCL, SDA, WP_L, PGOOD, VSYSS, LP_ACK, LP_REQ, VIL_B1-VIL_B3, LP_MODE, LSW1DRV, LSW2DRV, RESET_L, VIL_LDO, VIL_SYS, VL_FINE, EREG_EN1, EREG_EN2, EREG_POK, EREG1_OUT, EREG2_OUT		26	5000	KEYSTONE	N/A	TEST POINT; PIN DIA=0.1IN; TOTAL LENGTH=0.3IN; BOARD HOLE=0.04IN; RED; PHOSPHOR BRONZE WIRE SILVER PLATE FINISH;
LDO, GND1-GND3, LSW1-LSW3, BUCK1-BUCK3, VFINE, BLD_IO, INR_DRV, INR_OUT, IN_PHUP		15	5010	KEYSTONE	N/A	TESTPOINT WITH 1.80MM HOLE DIA, RED, MULTIPURPOSE;
C1, C3, C5		3	C1608X5R1A106K	TDK	10UF	CAPACITOR; SMT (0603); CERAMIC CHIP; 10UF; 10V; TOL=10%; MODEL=; TG=-55 DEGC TO +85 DEGC; TC=X5R
C2, C4, C6, C8, C10		5	ANY	ANY	22UF	CAPACITOR; SMT (0603); CERAMIC CHIP; 22UF; 6.3V; TOL=20%; MODEL=C SERIES; TG=-55 DEGC TO +85 DEGC; TC=X5R; FORMFACTOR
C7, C9		2	ANY	ANY	2.2UF	CAPACITOR; SMT (0402); CERAMIC; 2.2UF; 6.3V; TOL=[10%]; MODEL=C SERIES; TG=-55 DEGC TO +85 DEGC; TC=X5R
C14, C15		2	ANY	ANY	1UF	CAPACITOR; SMT (0402); CERAMIC CHIP; 1UF; 10V; TOL=10%; MODEL=; TG=-55 DEGC TO +85 DEGC; TC=X5R; FORMFACTOR
C16, C17, C154		3	ANY	ANY	4.7UF	CAPACITOR; SMT (0402); CERAMIC CHIP; 4.7UF; 10V; TOL=20%; MODEL=C SERIES; TG=-55 DEGC TO +85 DEGC; TC=X5R; FORMFACTOR
C22, C23, C35		3	TCJB107M006R0070	AVX	100UF	CAPACITOR; SMT (3528); TANTALUM CHIP; 100UF; 6.3V; TOL=20%; MODEL=TCJ SERIES
C25-C27, C110-C113, C115, C118, C120, C158, C248-C250		14	C0402C105K8PAC	KEMET	1UF	CAPACITOR; SMT (0402); CERAMIC CHIP; 1UF; 10V; TOL=10%; TG=-55 DEGC TO +85 DEGC; TC=X5R
C28-C30, C38		4	ANY	ANY	0.01UF	CAPACITOR; SMT (0402); CERAMIC CHIP; 0.01UF; 10V; TOL=10%; MODEL=C0402C SERIES; TG=-55 DEGC TO +125 DEGC; TC=X7R
C31-C33, C39		4	ANY	ANY	0.1UF	CAPACITOR; SMT; 0402; CERAMIC; 0.1uF; 10V; 10%; X5R; -55degC to + 125degC; 0 +/-30PPM/degC; FORMFACTOR ;
C108, C150, C151, C155-C157, C159, C203, C209, C216, C223, C233, C240		13	ANY	ANY	0.1UF	CAPACITOR; SMT (0402); CERAMIC CHIP; 0.1UF; 50V; TOL=10%; MODEL=C6A SERIES; TG=-55 DEGC TO +125 DEGC; TC=X7R; FORMFACTOR
C114		1	C0603C474K4RAC; GRM188R71C474K	KEMET/MURATA	0.47UF	CAPACITOR; SMT; 0603; CERAMIC; 0.47uF; 16V; 10%; X7R; -55degC to + 125degC; 0 +/-15% degC MAX.
C152, C153		2	C0402C06500-150JNP; GRM1555C1H150JA01	VENKEL LTD./MURATA	15PF	CAPACITOR; SMT (0402); CERAMIC CHIP; 15PF; 50V; TOL=5%; TG=-55 DEGC TO +125 DEGC; TC=C0G
C200, C207, C214, C221, C231, C238		6	C1005X5R1H472K050	TDK	4700PF	CAPACITOR; SMT (0402); CERAMIC CHIP; 4700PF; 50V; TOL=10%; TG=-55 DEGC TO +85 DEGC; TC=X5R
C201, C208, C215, C222, C232, C239		6	ANY	ANY	1000PF	CAPACITOR; SMT (0402); CERAMIC CHIP; 1000PF; 50V; TOL=10%; MODEL=C0G; TG=-55 DEGC TO +125 DEGC; TC=+; FORMFACTOR
C202, C210, C217, C224, C228-C230, C234, C241, C245-C247, C260, C262, C265		15	ANY	ANY	0.1UF	CAPACITOR; SMT (0402); CERAMIC CHIP; 0.1UF; 25V; TOL=10%; MODEL=C SERIES; TG=-55 DEGC TO +125 DEGC; TC=X7R; FORMFACTOR
C204, C205, C211, C212, C218, C219, C235, C236, C242, C243		10	GRM1555C1E101GA01	MURATA	100PF	CAPACITOR; SMT (0402); CERAMIC CHIP; 100PF; 25V; TOL=2%; MODEL=GRM SERIES; TG=-55 DEGC TO +125 DEGC; TC=C0G
C206, C213, C220, C227, C237, C244, C261, C263, C264		9	ANY	ANY	1UF	CAPACITOR; SMT (0402); CERAMIC CHIP; 1UF; 6.3V; TOL=20%; MODEL=C SERIES; TG=-55 DEGC TO +85 DEGC; TC=X5R ; FORMFACTOR
C225, C226		2	C0402C680J5GAC; GRM1555C1H680JA01	KEMET/MURATA	68PF	CAPACITOR; SMT; 0402; CERAMIC; 68pF; 50V; 5%; C0G; -55degC to + 125degC; 0 +/-30PPM/degC
D100, D101		2	LTST-C190YKT	LITE-ON ELECTRONICS, INC.	LTST-C190YKT	DIODE; LED; STANDARD; YELLOW; SMT (0603); PIV=5.0V; IF=0.02A; -55 DEGC TO +85 DEGC
D102, D103		2	LTST-C190CKT	LITE-ON ELECTRONICS, INC.	LTST-C190CKT	DIODE; LED; STANDARD; RED; SMT (0603); PIV=5.0V; IF=0.04A; -55 DEGC TO +85 DEGC
FB100		1	BLM18PG221SN1	MURATA	220	INDUCTOR; SMT (0603); FERRITE-BEAD; 220; TOL=+/-25%; 1.4A; -55 DEGC TO +125 DEGC
GND, VIN, GND4-GND7, VSYSS		7	9020 BUSS	WEICO WIRE	MAXIMPAD	EVK KIT PARTS; MAXIM PAD; WIRE; NATURAL; SOLID; WEICO WIRE; SOFT DRAWN BUS TYPE-S; 20AWG
J1-J3, J5-J7, J10, J103, J200, J202, J204, J206-J208, J210		15	TSW-102-07-T-S	SAMTEC	TSW-102-07-T-S	CONNECTOR; THROUGH HOLE; TSW SERIES; SINGLE ROW; STRAIGHT; 2PINS; -55 DEGC TO +105 DEGC
J4, J9, J101		3	PBC03SABN	SULLINS	PBC03SABN	CONNECTOR; MALE; THROUGH HOLE; BREAKAWAY; STRAIGHT; 3PINS

MAX77752 EV Kit Bill of Materials (continued)

REF_DES	DNI/DNP	QTY	MFG PART #	MANUFACTURER	VALUE	DESCRIPTION
J100		1	PBC06SAAN	SULLINS ELECTRONICS CORP.	PBC06SAAN	CONNECTOR; MALE; THROUGH HOLE; BREAKAWAY; STRAIGHT; 6PINS; -65 DEGC TO +125 DEGC
J102		1	10103592-0001LF	FCI CONNECT	10103592-0001LF	CONNECTOR; FEMALE; SMT; MICRO USB B-TYPE REVERSE; RIGHT ANGLE; 5PINS
J201, J203, J205, J209		4	PBC02DABN	SULLINS ELECTRONIC CORP.	PBC02DABN	CONNECTOR; MALE; THROUGH HOLE; BREAKAWAY; STRAIGHT; 4PINS
L1, L2		2	PIFE20161T-1R0MDR	CYNTEC	1UH	INDUCTOR; SMT; FERRITE BOBBIN CORE; 1UH; TOL=+/-20%; 2.8A; -55 DEGC TO +125 DEGC; FORMFACTOR
L3		1	CIGT252010EH1R0M	SAMSUNG ELECTRONICS	1UH	INDUCTOR; SMT (1008); MAGNETICALLY SHIELDED; 1UH; TOL=+/-20%; 4.3A
Q1-Q4, Q205		5	DMG3420U	DIODES INCORPORATED	DMG3420U	TRAN; N-CHANNEL ENHANCEMENT MODE MOSFET; NCH; SOT-23; PD-(0.74W); I-(5.47A); V-(20V)
Q100, Q101		2	FDY300NZ	FAIRCHILD SEMICONDUCTOR	FDY300NZ	TRAN; SINGLE N-CHANNEL 2.5V SPECIFIED POWERTRENCH MOSFET; NCH; SC89; PD-(0.625W); I-(0.6A); V-(20V)
Q200-Q202, Q204		4	IRLR8259TRPBF	INTERNATIONAL RECTIFIER	IRLR8259TRPBF	TRAN; HEXFET POWER MOSFET; NCH; DPAK; PD-(48W); I-(57A); V-(25V)
Q203		1	IRFHM8337TRPBF	INTERNATIONAL RECTIFIER	IRFHM8337TRPBF	TRAN; HEXFET POWER MOSFET; NCH; PQFN8; PD-(2.8W); I-(18A); V-(30V)
Q206-Q209		4	FDY3000NZ	FAIRCHILD SEMICONDUCTOR	FDY3000NZ	TRAN; DUAL N-CHANNEL 2.5V SPECIFIED POWERTRENCH MOSFET; NCH; SOT563-6; PD-(0.625W); I-(0.6A); V-(20V)
QSCL, QSDA		2	5002	KEYSTONE	N/A	TEST POINT; PIN DIA=0.1IN; TOTAL LENGTH=0.3IN; BOARD HOLE=0.04IN; WHITE; PHOSPHOR BRONZE WIRE SILVER;
R1		1	WSL0805R0200FEA18	VISHAY DALE	0.02	RESISTOR; 0805; 0.02 OHM; 1%; 75PPM; 0.25W; THICK FILM
R2, R3, R13-R20, R23-R25, R30, R31, R33, R34, R36-R39		21	ERJ-2GE0R00X	PANASONIC	0	RESISTOR; 0402; 0 OHM; 0%; JUMPER; 0.10W; THICK FILM
R21, R142		2	ANY	ANY	0	RESISTOR; 0603; 0 OHM; 0%; JUMPER; 0.10W; THICK FILM; FORMFACTOR
R100, R118		2	ANY	ANY	4.7K	RESISTOR, 0402, 4.7K OHM, 1%, 100PPM, 0.0625W, THICK FILM; FORMFACTOR
R107, R108		2	ANY	ANY	2.2K	RESISTOR, 0402, 2.2K OHM, 1%, 100PPM, 0.0625W, THICK FILM; FORMFACTOR
R110, R117		2	CRCW0402470RFK	VISHAY DALE	470	RESISTOR, 0402, 470 OHM, 1%, 100PPM, 0.0625W, THICK FILM
R113, R290-R297		9	CRCW040210K0FK; RC0402FR-0710K	VISHAY DALE; YAGEO PHICOMP	10K	RESISTOR; 0402; 10K; 1%; 100PPM; 0.0625W; THICK FILM
R103, R123, R114, R116		4	CRCW040222R0FK	VISHAY DALE	22	RESISTOR, 0402, 22 OHM, 1%, 100PPM, 0.0625W, THICK FILM
R4-R12, R32, R35, R115, R157, R159, R161, R262, R263, R266, R268		19	ANY	ANY	100K	RESISTOR; 0402; 100K; 1%; 100PPM; 0.0625W; THICK FILM; FORMFACTOR
R122		1	ANY	ANY	1M	RESISTOR; 0603; 1M; 1%; 100PPM; 0.10W; THICK FILM; FORMFACTOR
R135, R136, R139, R141, R143, R148, R155, R203, R213, R223, R233, R242, R252, R260, R261, R265, R267		17	ANY	ANY	0	RESISTOR; 0402; 0 OHM; 1%; 100PPM; 0.0625W; THICK FILM; FORMFACTOR
R26-R29, R137, R138		6	ANY	ANY	49.9	RESISTOR; 0402; 49.9 OHM; 1%; 100PPM; 0.0625W; THICK FILM; FORMFACTOR
R156		1	CRCW0402105KFK	VISHAY DALE	105K	RESISTOR; 0402; 105K OHM; 1%; 100PPM; 0.063W ; THICK FILM
R158		1	CRCW0402169KFK	VISHAY DALE	169K	RESISTOR; 0402; 169K OHM; 1%; 100PPM; 0.063W; THICK FILM
R160		1	CRCW04024752FK; 9C04021A4752FLHF3; CRCW040247K5FK	VISHAY DALE	47.5K	RESISTOR; 0402; 47.5K; 1%; 100PPM; 0.0625W; THICK FILM
R200, R210, R220, R224, R225, R230, R240, R250		8	CRCW040220K0FK	VISHAY DALE	20K	RESISTOR; 0402; 20K OHM; 1%; 100PPM; 0.063W; THICK FILM
R109, R111, R201, R211, R221, R231, R241, R251, R289		9	CRCW0402100RFK; 9C04021A1000FL; RC0402FR-07100RL	VISHAY DALE; PANASONIC; YAGEO PHYCOMP	100	RESISTOR; 0402; 100 OHM; 1%; 100PPM; 0.063W; THICK FILM
R202, R212, R222, R232, R243, R253		6	CRCW0402680RFK;RC0402FR-07680RL	VISHAY DALE/YAGEO PHICOMP	680	RESISTOR, 0402, 680 OHM, 1%, 100PPM, 0.0625W, THICK FILM
R204, R205, R214, R215, R244, R245		6	CRCW04024K75FK	VISHAY DALE	4.75K	RESISTOR; 0402; 4.75K; 1%; 100PPM; 0.0625W; THICK FILM
R206, R216, R226, R236, R246, R256		6	CRCW04021M00FK	VISHAY DALE	1M	RESISTOR; 0402; 1M; 1%; 100PPM; 0.0625W; THICK FILM

MAX77752 EV Kit Bill of Materials (continued)

REF DES	DNI/DNP	QTY	MFG PART #	MANUFACTURER	VALUE	DESCRIPTION
R207, R208, R217, R218, R227, R228, R237, R238, R247, R248, R257, R258		12	ANY	ANY	1K	RESISTOR; 0402; 1K; 1%; 100PPM; 0.0625W; THICK FILM; FORMFACTOR
R209, R219, R249		3	CRA2512-FZ-R100ELF	BOURNS	0.1	RESISTOR; 2512; 0.1 OHM; 1%; 75PPM; 3W; METAL FILM
R229		1	WSL2512R0200F	N/A	0.02	RESISTOR; 2512; 0.02 OHM; 1%; 75PPM; 1.0W; THICK FILM
R234, R235		2	CR0402-16W-3161FT; CRCW04023K16FK	VENKEL LTD./VISHAY DALE	3.16K	RESISTOR; 0402; 3.16K OHM; 1%; 100PPM; 0.063W; THICK FILM
R239, R259		2	CSR1206FT1R00	STACKPOLE ELECTRONICS INC.	1	RESISTOR; 1206; 1 OHM; 1%; 100PPM; 0.5W; THICK FILM
R254, R255		2	CRCW040276K8FK	VISHAY DALE	76.8K	RESISTOR; 0402; 76.8K OHM; 1%; 100PPM; 0.063W; THICK FILM
R269, R271, R273, R287, R288		5	CRCW060318R0FK	VISHAY DALE	18	RESISTOR, 0603, 18 OHM, 1%, 100PPM, 0.10W, THICK FILM
R270, R272, R274		3	CRCW060318R0FK	VISHAY DALE	180	RESISTOR, 0603, 180 OHM, 1%, 100PPM, 0.10W, THICK FILM
R275, R277, R279, R281, R283, R285		6	ERJ-2RKF4703X	PANASONIC	470K	RESISTOR, 0402, 470K OHM, 1%, 100PPM, 0.0625W, THICK FILM
R276, R278, R280, R282, R284, R286		6	CRCW0402649KFK	VISHAY DALE	649K	RESISTOR; 0402; 649K OHM; 1%; 100PPM; 0.063W; THICK FILM
U1		1	MAX77752	MAXIM	MAX77752	EVKIT PART; IC; OUTLINE DRAWING: 21-0140; PACKAGE CODE: T4055-1C; TQFN40-EP; CID4 = 0x07
U2, U3		2	MAX1818EUT18+	MAXIM	MAX1818EUT18+	IC; VREG; 0.5A LOW-DROPOUT LINEAR REGULATOR; SOT23-6
U100		1	MAXQ2000-RBX+	MAXIM	MAXQ2000-RBX+	IC; CTRL; LOW-POWER LCD MICROCONTROLLER; TQFN56-EP 8X8
U101		1	FT232RQ	FUTURE TECHNOLOGY DEVICES INTL LTD.	FT232RQ	IC; INFC; UART INTERFACE IC USB TO SERIAL; QFN32-EP 5X5
U102-U104		3	MAX8512EXK	MAXIM	MAX8512EXK	IC, VREG, Ultra-Low-Noise, High PSRR, Adjustable Vout, SC70-5
U107		1	MAX3395EETC	MAXIM	MAX3395EETC	IC; TRANS; 15KV ESD-PROTECTED HIGH-DRIVE CURRENT QUAD-LEVEL TRANSLATOR WITH SPEED-UP CIRCUITRY; TQFN12 4X4
U200-U205		6	MAX44251AUA+	MAXIM	MAX44251AUA+	IC; OPAMP; ULTRA-PRECISION; LOW-NOISE OP AMP; UMAX8
U206, U207		2	MAX5815AAUD+	MAXIM	MAX5815AAUD+	IC; DAC; ULTRA-SMALL; QUAD-CHANNEL; 12-BIT BUFFERED OUTPUT DAC WITH INTERNAL REFERENCE AND I2C INTERFACE; TSSOP14
U208, U210		2	SX1502I087TRT	SEMTECH	SX1502I087TRT	IC; XPND; 8-CHANNEL LOW VOLTAGE GPIO EXPANDER; UTQFN20-EP 3X3
U209		1	MAX1697UEUT+	MAXIM	MAX1697UEUT+	IC; INV; INVERTING CHARGE PUMP WITH SHUTDOWN; SOT23-6
VB1S-VB3S, VLDOS		4	U.FL-R-SMT-1	HIROSE ELECTRIC CO LTD.	U.FL-R-SMT-1	CONNECTOR; MALE; SMT; ULTRA SMALL SURFACE MOUNT COAXIAL CONNECTOR; STRAIGHT; 2PINS
Y101		1	CX32255B16000D0FLJZZ	KYOCERA-KINSEKI	16MHZ	CRYSTAL; SMT (3225) 3.2X2.5; 8PF; 16MHZ; +/-10PPM; +/-15PPM
PCB		1	MAX77752_REV B	MAXIM	PCB	PCB:MAX77752_REV B
R22	DNP	0	CRCW08050000Z0EAHP	VISHAY DRALORIC	0	RESISTOR; 0805; 0 OHM; 0%; JUMPER; 0.5W; THICK FILM
C11-C13, C18, C24, C40	DNP	0	N/A	N/A	OPEN	CAPACITOR; SMT (0603); OPEN; FORMFACTOR
C19-C21, C34, C36, C37, C129, C134	DNP	0	N/A	N/A	OPEN	CAPACITOR; SMT (0402); OPEN; FORMFACTOR

NOTE: DNP—DO NOT PROCURE

Ordering Information

PART	TYPE
MAX77752EVKIT#	EV Kit

#Denotes RoHS compliant.

MAX77752 EV Kit Schematic

Part Number	Pin Strap	7-bit	8-bit Write	8-bit Read
MAX77752 PMIC OPTION A	OTP_I2C_ADDR[0]=0b00	0x60 0b110 0000	0xC0 0b1100 0000	0xC1 0b1100 0001
MAX77752 PMIC OPTION B	OTP_I2C_ADDR[1]=0b01	0x61 0b110 0001	0xC2 0b1100 0010	0xC3 0b1100 0011
MAX77752 PMIC OPTION C	OTP_I2C_ADDR[1]=0b10	0x62 0b110 0010	0xC4 0b1100 0100	0xC5 0b1100 0101
MAX77752 PMIC OPTION D	OTP_I2C_ADDR[1]=0b11	0x63 0b110 0011	0xC6 0b1100 0110	0xC7 0b1100 0111
MAX5815 * (DAC) U207	ADDR1=ADDR0=+3.3V	0x10 0b001 0000	0x20 0b0010 0000	0x21 0b0010 0001
MAX5815 * (DAC) U205	ADDR1=ADDR0=GND	0x1F 0b001 1111	0x3E 0b0011 1110	0x3F 0b0011 1111
SX1502 U210 GPIO EXPANDER	ADDR=GND	0x20 0b010 0000	0x40 0b0100 0000	0x41 0b0100 0001
SX1502 U208 GPIO EXPANDER	ADDR=3.3V	0x21 0b010 0001	0x42 0b0100 0010	0x43 0b0100 0011

* MAX5815 also responds to an I2C broadcast address 0b0001000

MAX77752 EV Kit Schematic (continued)

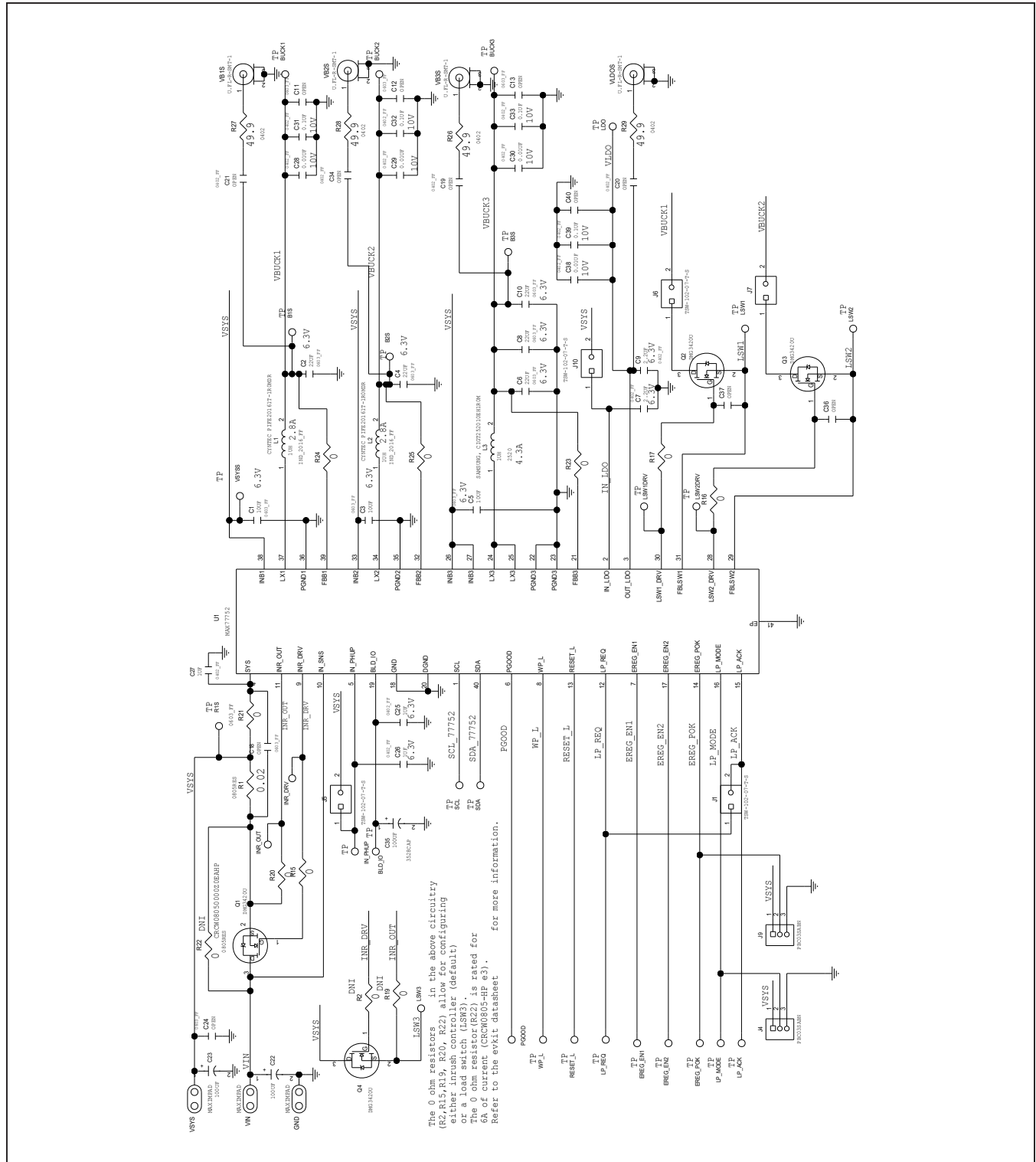

MAX77752 EV Kit Schematic (continued)

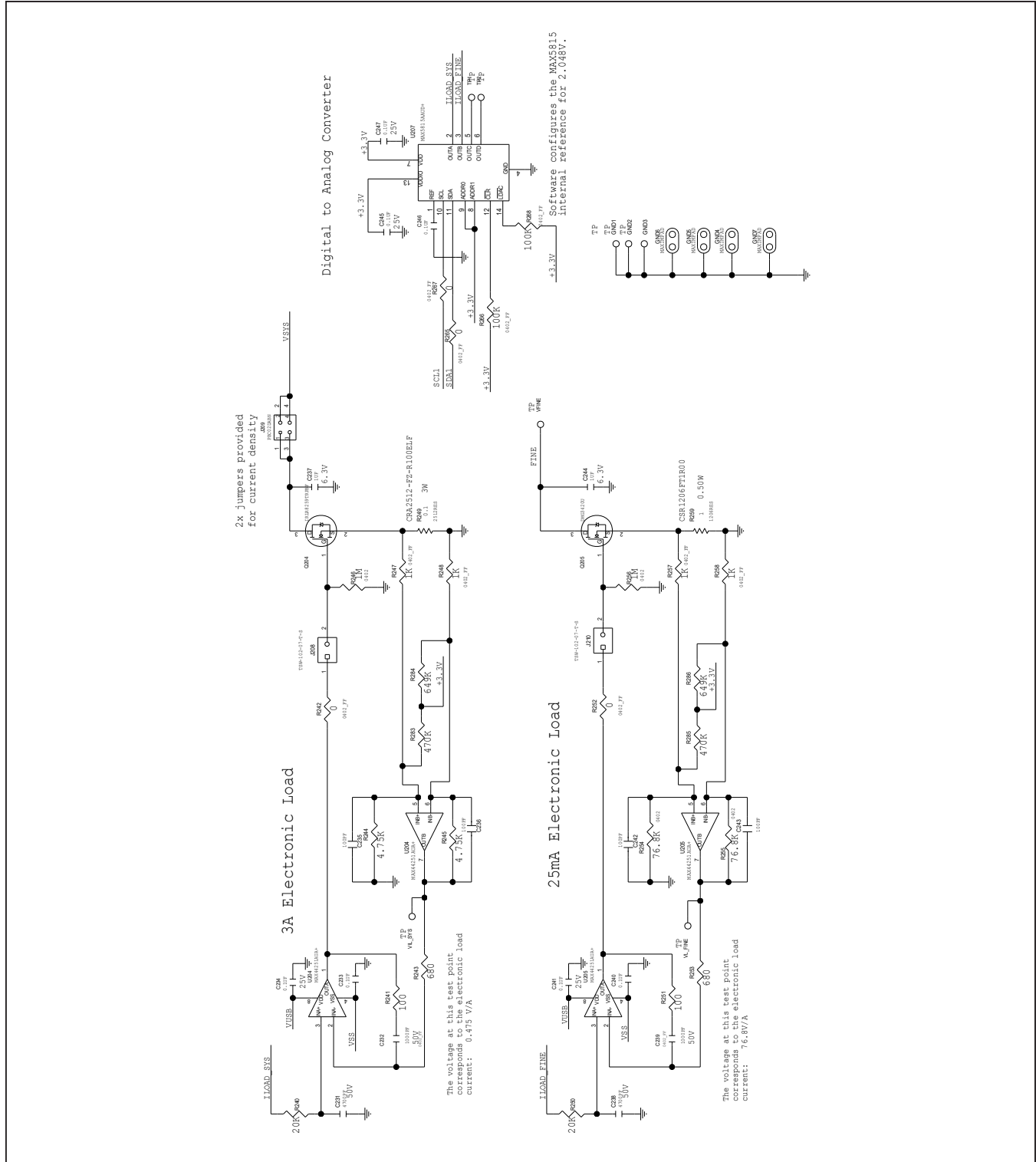

MAX77752 EV Kit Schematic (continued)

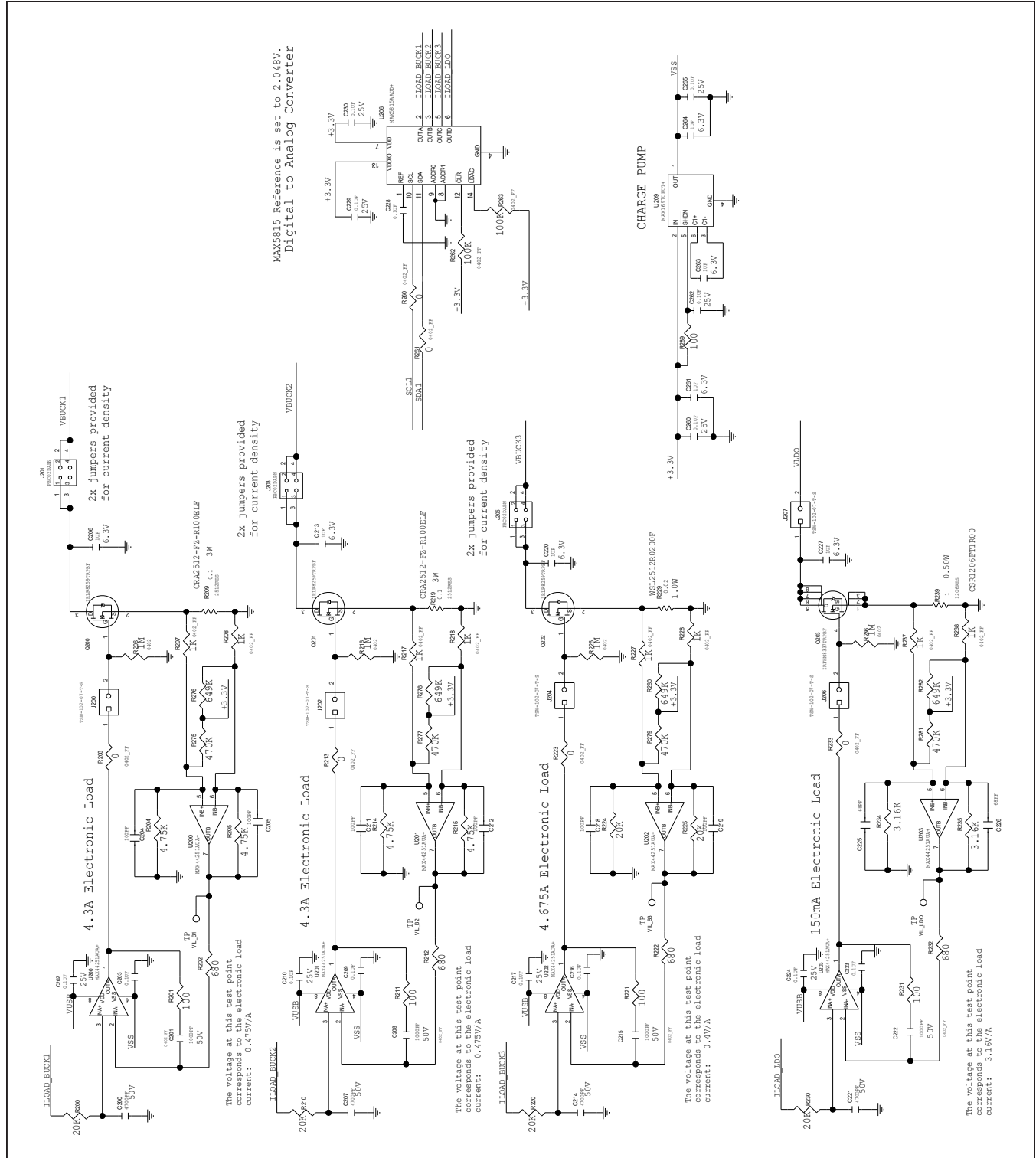

MAX77752 EV Kit Schematic (continued)

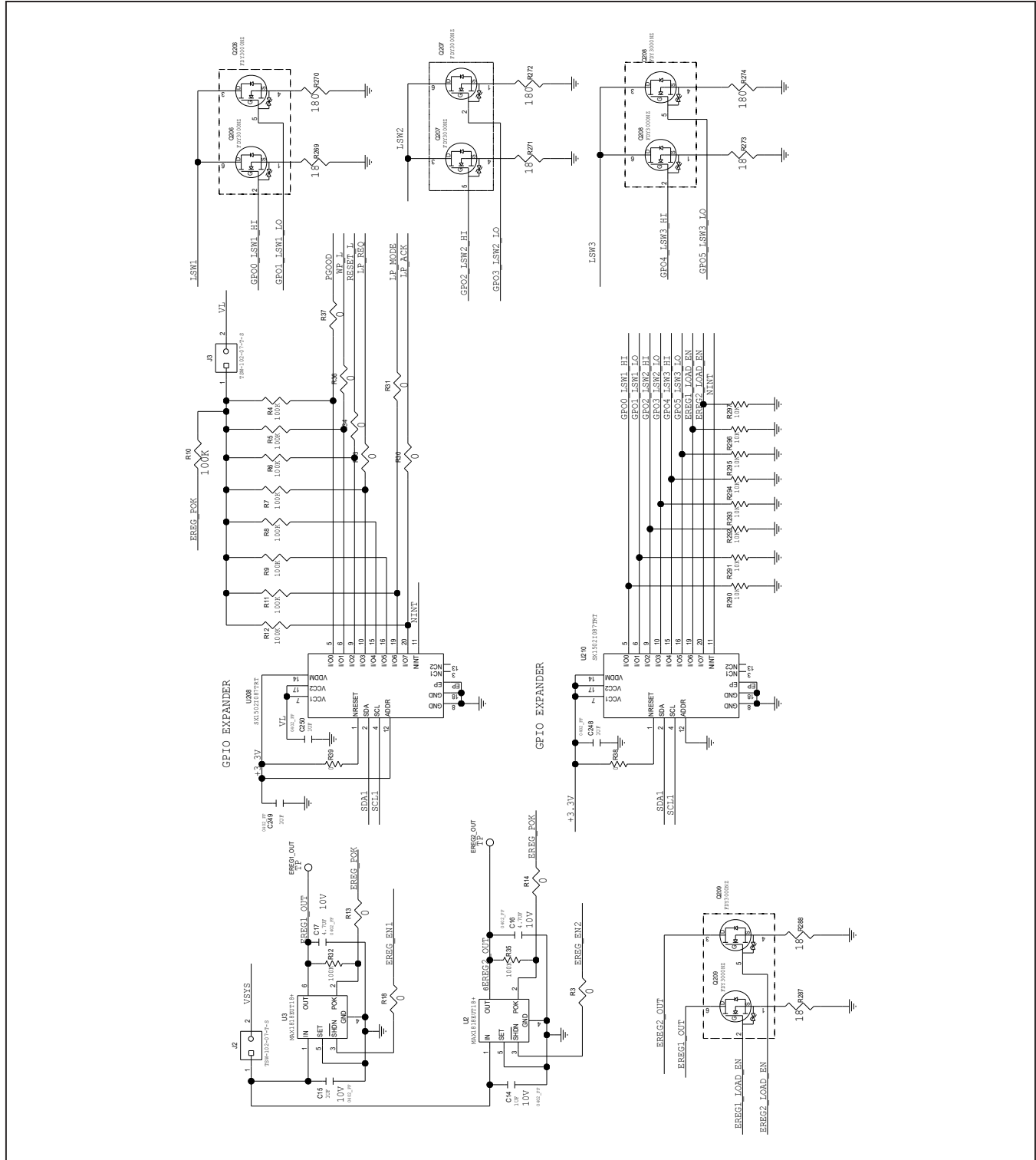

MAX77752 EV Kit Schematic (continued)

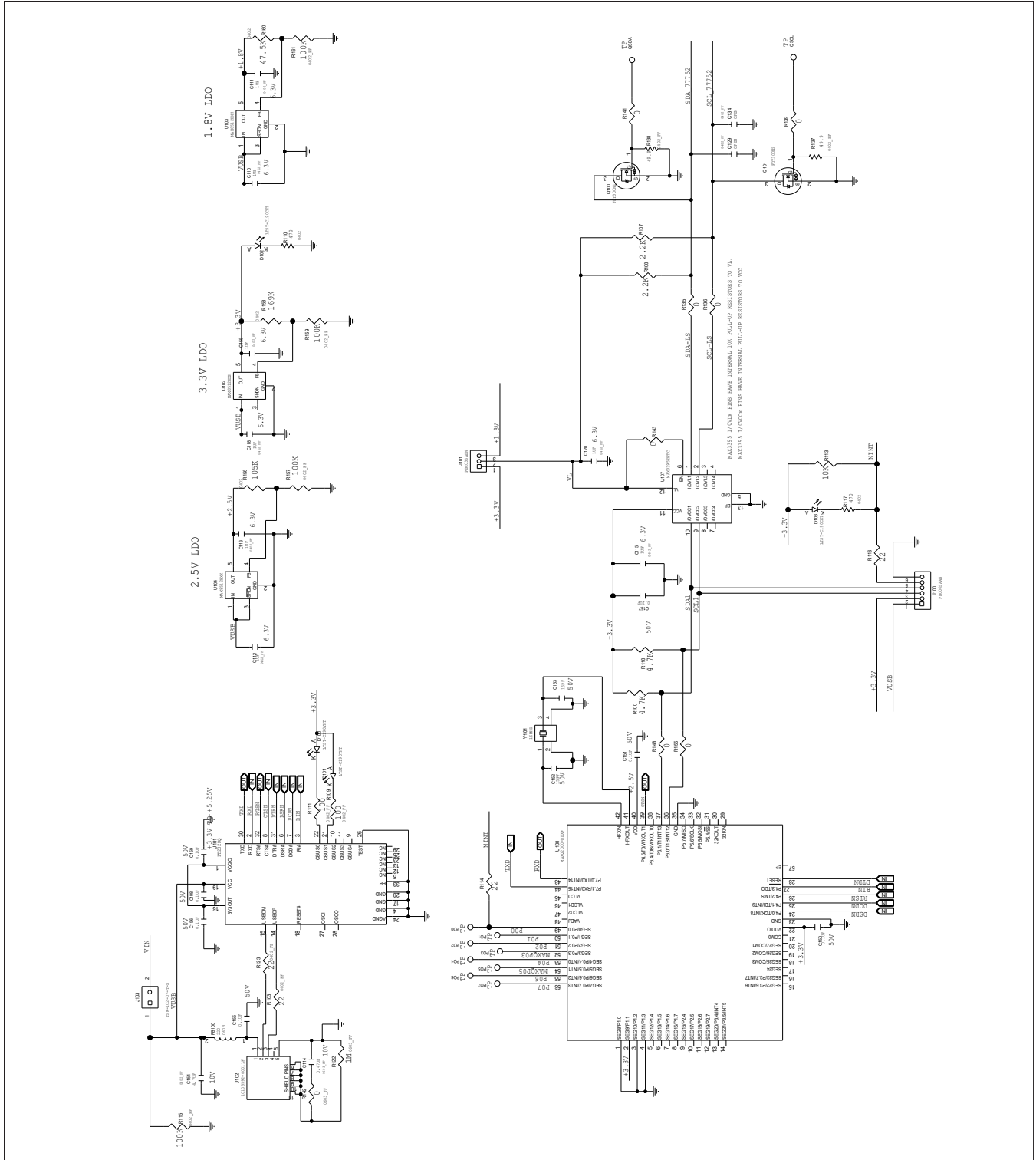

MAX77752 EV Kit PCB Layouts

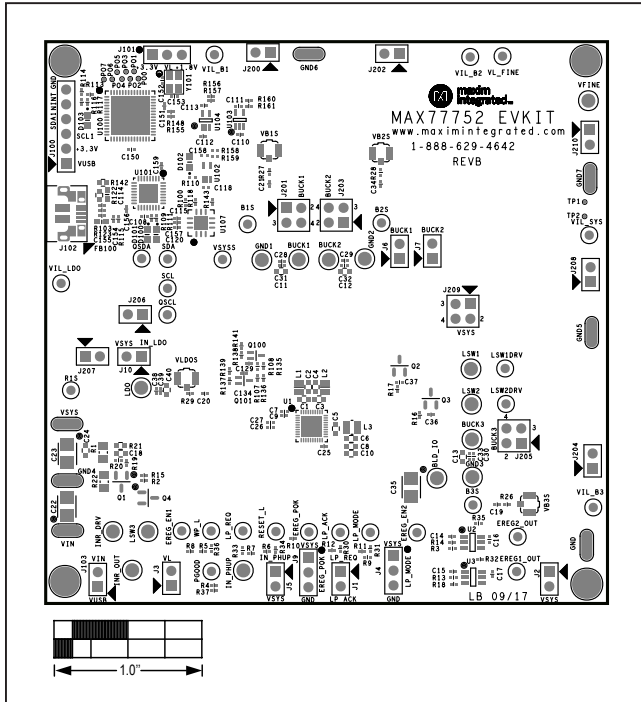

MAX77752 EV Kit Component Placement Guide—
Top Silkscreen

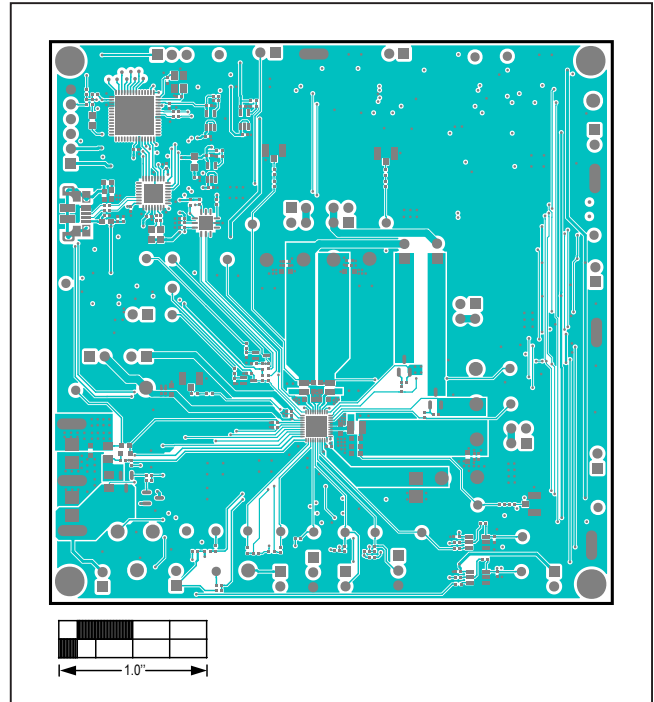

MAX77752 EV Kit PCB Layout—Top Layer

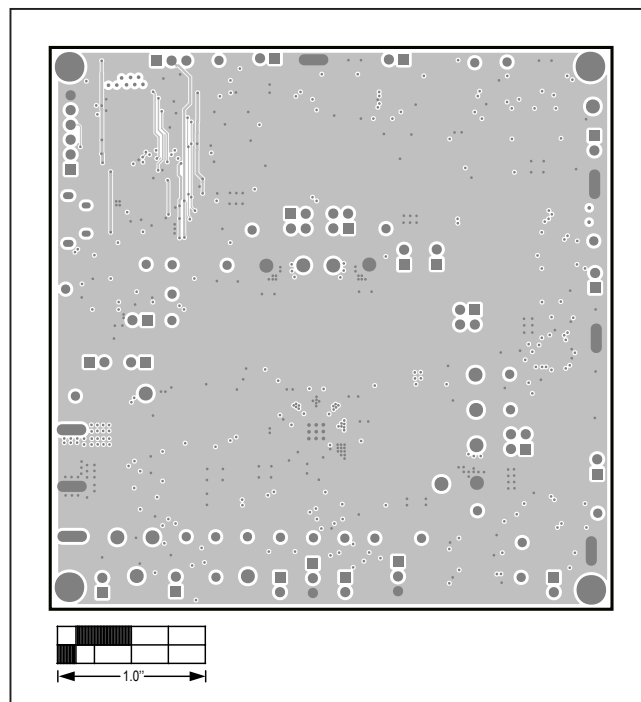

MAX77752 EV Kit PCB Layout—Internal Layer 2

MAX77752 EV Kit PCB Layouts (continued)

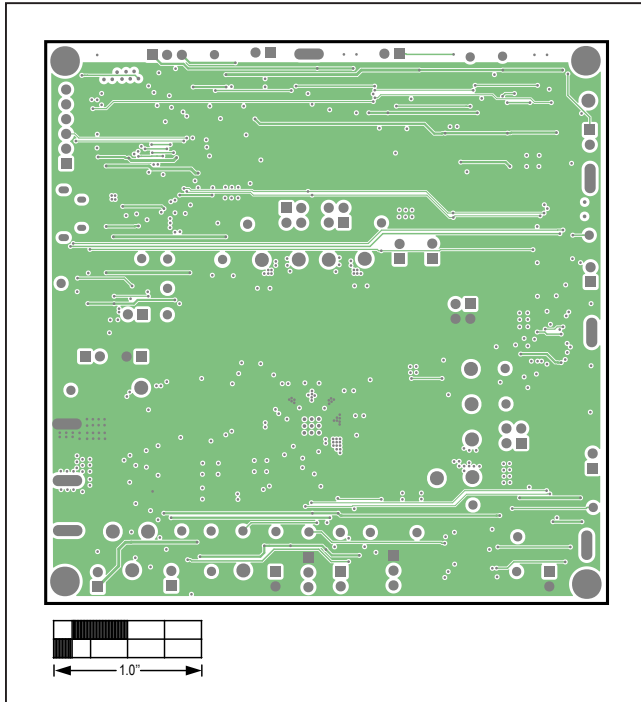

MAX77752 EV Kit PCB Layout—Internal Layer 3

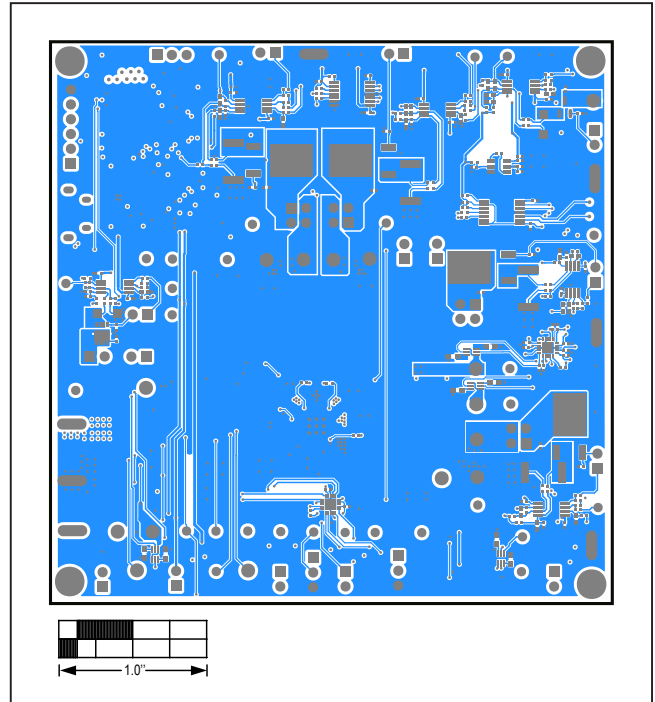

MAX77752 EV Kit PCB Layout—Bottom Layer

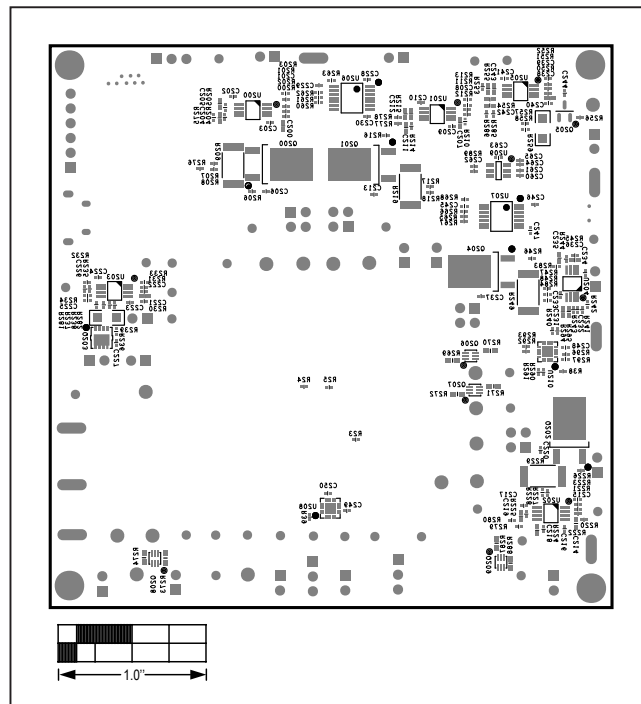

MAX77752 EV Kit Component Placement Guide—
Bottom Silkscreen

Revision History

REVISION NUMBER	REVISION DATE	DESCRIPTION	PAGES CHANGED
0	10/17	Initial release	—

For pricing, delivery, and ordering information, please contact Maxim Direct at 1-888-629-4642, or visit Maxim Integrated's website at www.maximintegrated.com.

Maxim Integrated cannot assume responsibility for use of any circuitry other than circuitry entirely embodied in a Maxim Integrated product. No circuit patent licenses are implied. Maxim Integrated reserves the right to change the circuitry and specifications without notice at any time.

Компания «Океан Электроники» предлагает заключение долгосрочных отношений при поставках импортных электронных компонентов на взаимовыгодных условиях!

Наши преимущества:

- Поставка оригинальных импортных электронных компонентов напрямую с производств Америки, Европы и Азии, а так же с крупнейших складов мира;
- Широкая линейка поставок активных и пассивных импортных электронных компонентов (более 30 млн. наименований);
- Поставка сложных, дефицитных, либо снятых с производства позиций;
- Оперативные сроки поставки под заказ (от 5 рабочих дней);
- Экспресс доставка в любую точку России;
- Помощь Конструкторского Отдела и консультации квалифицированных инженеров;
- Техническая поддержка проекта, помощь в подборе аналогов, поставка прототипов;
- Поставка электронных компонентов под контролем ВП;
- Система менеджмента качества сертифицирована по Международному стандарту ISO 9001;
- При необходимости вся продукция военного и аэрокосмического назначения проходит испытания и сертификацию в лаборатории (по согласованию с заказчиком);
- Поставка специализированных компонентов военного и аэрокосмического уровня качества (Xilinx, Altera, Analog Devices, Intersil, Interpoint, Microsemi, Actel, Aeroflex, Peregrine, VPT, Syfer, Eurofarad, Texas Instruments, MS Kennedy, Miteq, Cobham, E2V, MA-COM, Hittite, Mini-Circuits, General Dynamics и др.);

Компания «Океан Электроники» является официальным дистрибьютором и эксклюзивным представителем в России одного из крупнейших производителей разъемов военного и аэрокосмического назначения «JONHON», а так же официальным дистрибьютором и эксклюзивным представителем в России производителя высокотехнологичных и надежных решений для передачи СВЧ сигналов «FORSTAR».



JONHON

«JONHON» (основан в 1970 г.)

Разъемы специального, военного и аэрокосмического назначения:

(Применяются в военной, авиационной, аэрокосмической, морской, железнодорожной, горно- и нефтедобывающей отраслях промышленности)

«FORSTAR» (основан в 1998 г.)

ВЧ соединители, коаксиальные кабели, кабельные сборки и микроволновые компоненты:

(Применяются в телекоммуникациях гражданского и специального назначения, в средствах связи, РЛС, а так же военной, авиационной и аэрокосмической отраслях промышленности).



Телефон: 8 (812) 309-75-97 (многоканальный)

Факс: 8 (812) 320-03-32

Электронная почта: ocean@oceanchips.ru

Web: <http://oceanchips.ru/>

Адрес: 198099, г. Санкт-Петербург, ул. Калинина, д. 2, корп. 4, лит. А