

## Low Noise Amplifier 700 MHz - 6 GHz

Rev. V1

### Features

- Low Noise Figure:
  - 0.35 dB @ 1.9 GHz
  - 0.50 dB @ 2.6 GHz
- High Gain:
  - 22 dB @ 2.6 GHz
  - 15 dB @ 6.0 GHz
- High Linearity: 33 dBm OIP3
- Single Voltage Bias: 3 - 5 V
- Integrated Active Bias Circuit
- Current Adjustable 30 - 80 mA
- Lead-Free 2 mm 8-LD PDFN Package
- Halogen-Free "Green" Mold Compound
- RoHS\* Compliant and 260°C Reflow Compatible

### Functional Block Diagram

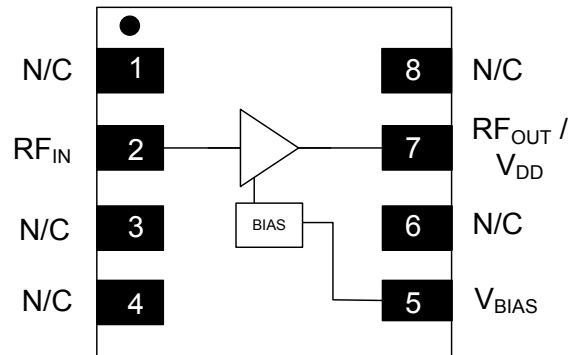

### Description

The MAAL-011078 is a high dynamic range, single stage MMIC LNA with ultra low noise figure, high gain and excellent linearity. This amplifier is designed for operation from 700 MHz to 6 GHz and is housed in a lead-free 2 mm 8-lead PDFN plastic package.

This low noise amplifier has an integrated active bias circuit allowing direct connection to 3 V or 5 V bias and minimizing variations over temperature and process. The bias current is set by an external resistor, so the user can customize the power consumption to fit the application.  $V_{BIAS}$  can be utilized as an enable pin to power the device up and down during operation.

In the 50  $\Omega$  environment and at 3 V, the MAAL-011078 offers 0.5 dB noise figure at 2.6 GHz, with 22 dB of gain and over 33 dBm output third order intercept point (OIP3). It is ideal for 4G cellular infrastructure and Wi-Fi applications.

### Pin Configuration<sup>3</sup>

Pin No.	Pin Name	Description
1	N/C	No Connection
2	RF <sub>IN</sub>	RF Input
3	N/C	No Connection
4	N/C	No Connection
5	V <sub>BIAS</sub>	Bias Voltage
6	N/C	No Connection
7	RF <sub>OUT</sub> / V <sub>DD</sub>	RF Output / Drain Voltage
8	N/C	No Connection
9	Pad <sup>4</sup>	Ground

- MACOM recommends connecting unused package pins to ground.
- The exposed pad centered on the package bottom must be connected to RF, DC and thermal ground.

### Ordering Information<sup>1,2</sup>

Part Number	Package
MAAL-011078-TR1000	1000 piece reel
MAAL-011078-TR3000	3000 piece reel
MAAL-011078-001SMB	Sample Board 2.3 - 2.7 GHz

- Reference Application Note M513 for reel size information.
- All sample boards include 3 loose parts.

\*Restrictions on Hazardous Substances,  
European Union Directive 2011/65/EU.

**Electrical Specifications: Freq = 1.9 GHz, V<sub>DD</sub> = 3 V, +25°C, Z<sub>0</sub> = 50 Ω, V<sub>BIAS</sub> = 2.3 V<sup>5</sup>**

Parameter	Test Conditions	Units	Min.	Typ.	Max.
Noise Figure	-	dB	—	0.35	0.7
Gain	-	dB	21	23	25
Input Return Loss <sup>6</sup>	-	dB	—	5	—
Output Return Loss <sup>6</sup>	-	dB	—	5	—
Output IP3	P <sub>IN</sub> = -22 dBm, tones 11 MHz apart	dBm	—	33	—
Output P1dB	-	dBm	—	17.5	—
Total Current	I <sub>DQ</sub> = I <sub>DD</sub> + I <sub>BIAS</sub>	mA	39	50	68

5. Refer to biasing options on page 3.

6. Return Loss can be improved with external matching components. Refer to application section.

## Absolute Maximum Ratings<sup>7,8,9</sup>

Parameter	Absolute Maximum
RF Input Power CW	19 dBm
V <sub>DD</sub>	6 V
V <sub>BIAS</sub>	5 V
Storage Temperature	-55°C to +150°C
Operating Temperature	-40°C to +85°C
Junction Temperature <sup>10</sup>	+150°C

7. Exceeding any one or combination of these limits may cause permanent damage to this device.
8. MACOM does not recommend sustained operation near these survivability limits.
9. Operating at nominal conditions with T<sub>J</sub> ≤ 150°C will ensure MTTF > 1 × 10<sup>6</sup> hours.
10. Junction Temperature (T<sub>J</sub>) = T<sub>C</sub> + θ<sub>JC</sub> \* ((V \* I) - (P<sub>OUT</sub> - P<sub>IN</sub>))  
 Typical thermal resistance (θ<sub>JC</sub>) = 83°C/W
  - a) For T<sub>C</sub> = +25°C,  
T<sub>J</sub> = 33°C @ 3 V, 0.05 A, P<sub>OUT</sub> = 17.5 dBm, P<sub>IN</sub> = -4.5 dBm
  - b) For T<sub>C</sub> = +85°C,  
T<sub>J</sub> = 93°C @ 3 V, 0.05 A, P<sub>OUT</sub> = 17.5 dBm, P<sub>IN</sub> = -4.5 dBm

## Handling Procedures

Please observe the following precautions to avoid damage:

## Static Sensitivity

Gallium Arsenide Integrated Circuits are sensitive to electrostatic discharge (ESD) and can be damaged by static electricity. Proper ESD control techniques should be used when handling these devices.

## Biasing Options

The MAAL-011078 bias can be set in 2 different ways: using only  $V_{DD}$  or using separate  $V_{DD}$  and  $V_{BIAS}$  voltages. A separate  $V_{BIAS}$  voltage allows pin 5 ( $V_{BIAS}$ ) to be used as an enable pin to power the device up and down during operation.

For both bias methods select the value of  $R_{BIAS}$  to achieve the desired current based on the tables on page 4, and use DC blocks at pin 2 ( $RF_{IN}$ ) and pin 7 ( $RF_{OUT} / V_{DD}$ ).

### Biasing Option - $V_{DD}$ only

To use only  $V_{DD}$ , connect pin 7 ( $RF_{OUT} / V_{DD}$ ) to  $V_{DD}$  through an RF choke inductor and connect pin 5 ( $V_{BIAS}$ ) to  $V_{DD}$  through bias resistor  $R_{BIAS}$  as shown in Figure 1.

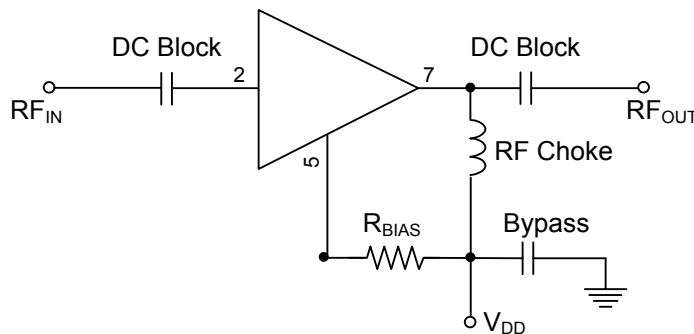

Figure 1

### Biasing Option - Separate $V_{DD}$ and $V_{BIAS}$ Voltages ( $V_{BIAS} \leq V_{DD}$ )

To use separate  $V_{DD}$  and  $V_{BIAS}$  voltages, connect pin 7 ( $RF_{OUT} / V_{DD}$ ) to  $V_{DD}$  through an RF choke inductor and connect pin 5 ( $V_{BIAS}$ ) to  $V_{BIAS}$  through bias resistor  $R_{BIAS}$  as shown in Figure 2. Typical current ( $I_{BIAS}$ ) draw for pin 5 ( $V_{BIAS}$ ) is 1.4 mA @  $V_{BIAS} = 3$  V and 1  $\mu$ A @  $V_{BIAS} = 0$  V. Typical current ( $I_{DD}$ ) draw for pin 7 ( $RF_{OUT} / V_{DD}$ ) is < 1  $\mu$ A @  $V_{BIAS} = 0$  V.

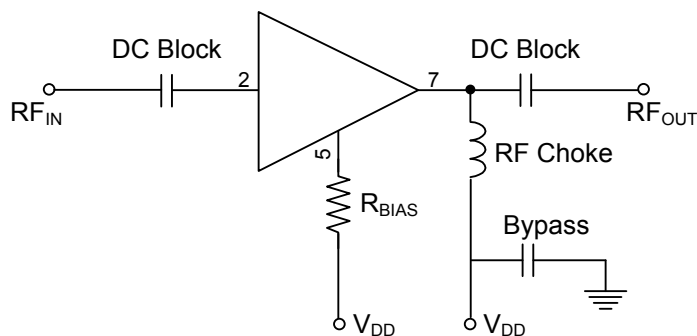
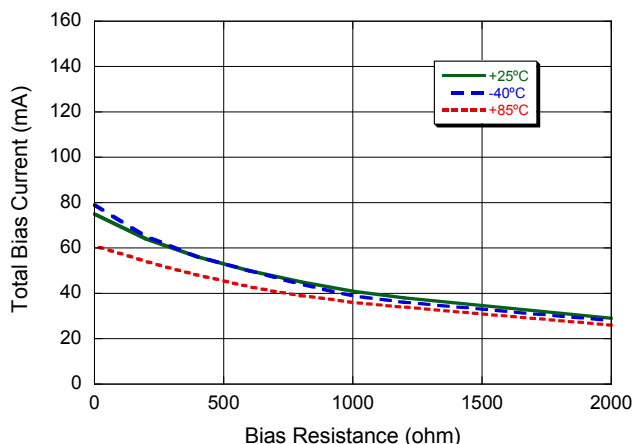

Figure 2

## Typical Performance Curves of the Active Bias Circuit

Current,  $V_{DD} = 3\text{ V}$



Current,  $V_{DD} = 4\text{ V}$

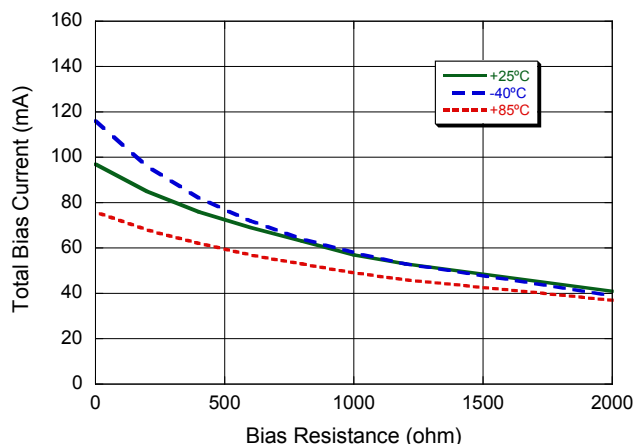

Current,  $V_{DD} = 5\text{ V}$

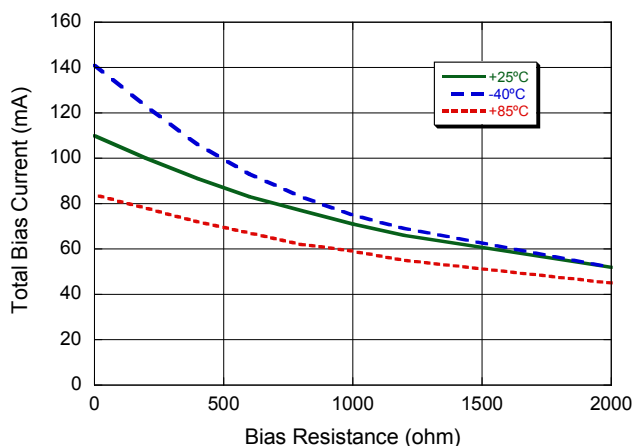

## Bias Table

Bias Resistance ( $\Omega$ )	Total Current (mA)								
	$V_{DD} = 3\text{ V}$			$V_{DD} = 4\text{ V}$			$V_{DD} = 5\text{ V}$		
	+25°C	-40°C	+85°C	+25°C	-40°C	+85°C	+25°C	-40°C	+85°C
2000	29	28	26	41	39	37	52	52	45
1200	38	36	34	53	53	46	66	69	55
1000	41	39	36	57	58	49	71	75	59
800	45	44	39	63	64	53	77	83	62
600	50	50	43	69	72	57	83	93	67
400	56	56	48	76	82	62	91	106	72
200	64	65	54	85	96	68	100	123	78
0	75	79	61	97	116	76	110	141	84

**Typical Performance Curves @ 3 V / 50 mA,  $Z_0 = 50 \Omega$**

**Gain**

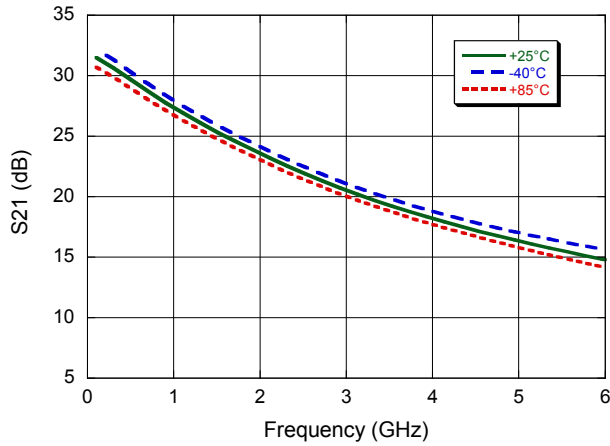

**Noise Figure**

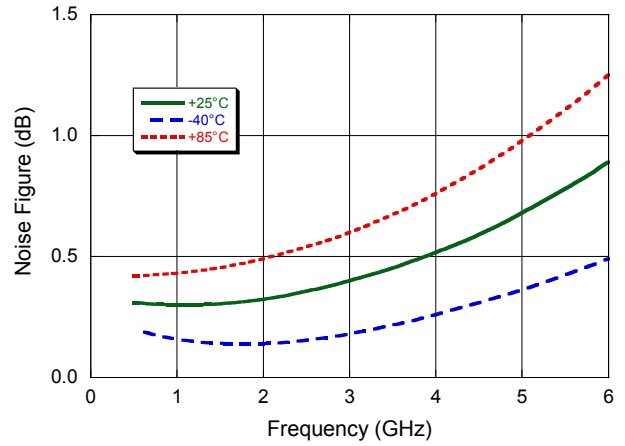

**Input Return Loss**

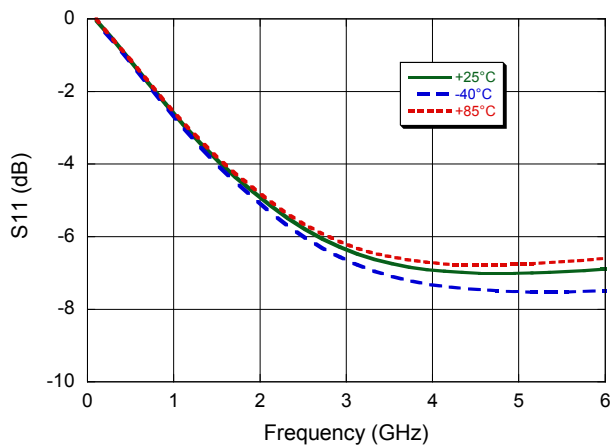

**Output Return Loss**

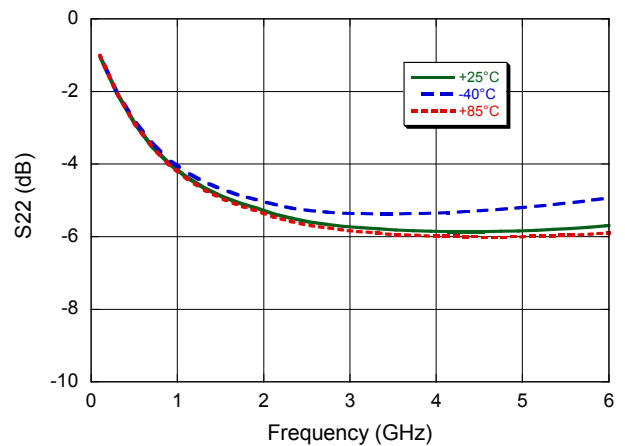

**OIP3**

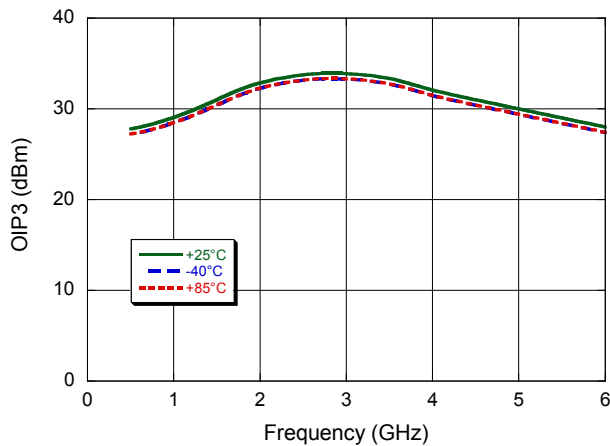

**P1dB**

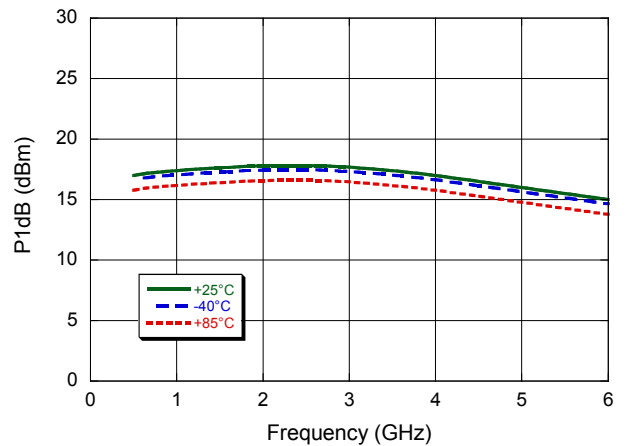

## Low Noise Amplifier 700 MHz - 6 GHz

Rev. V1

### Typical Performance Curves @ 5 V / 70 mA, $Z_0 = 50 \Omega$

**Gain**

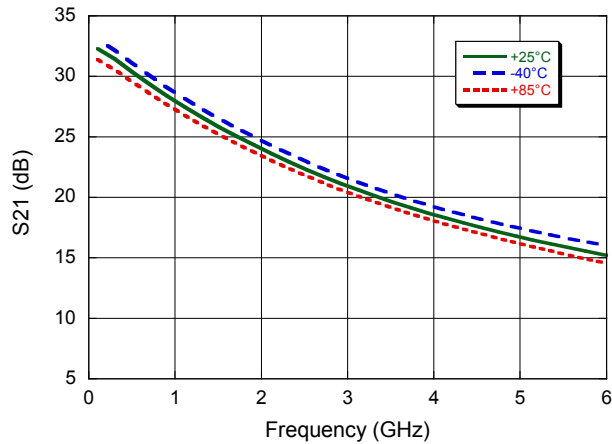

**Noise Figure**

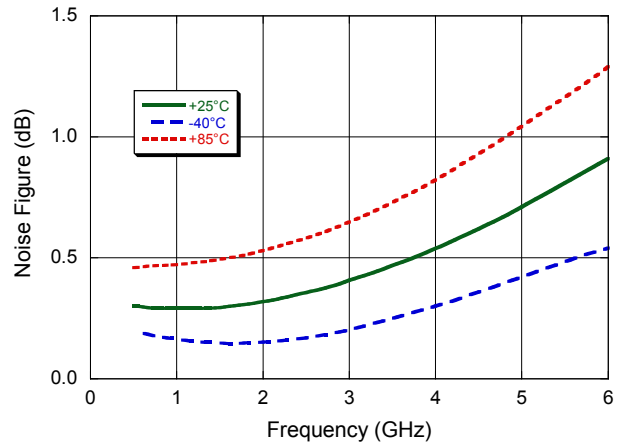

**Input Return Loss**

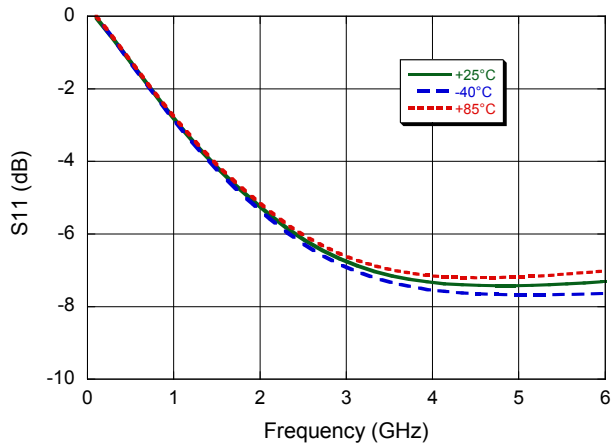

**Output Return Loss**

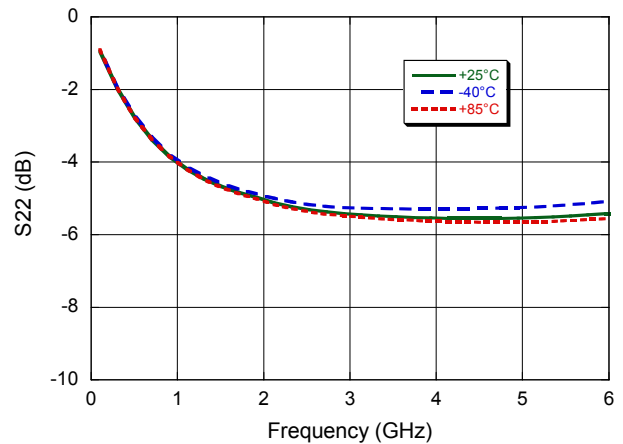

**OIP3**

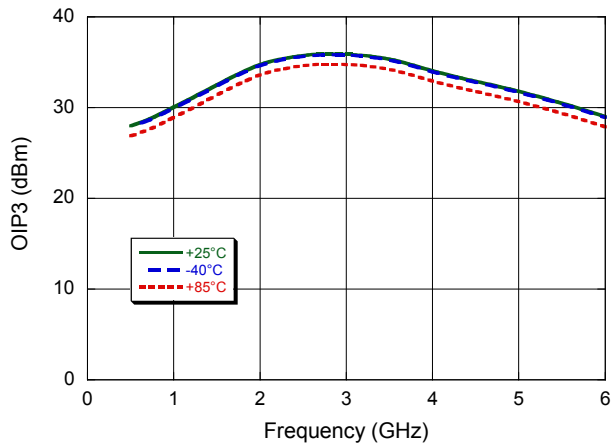

**P1dB**

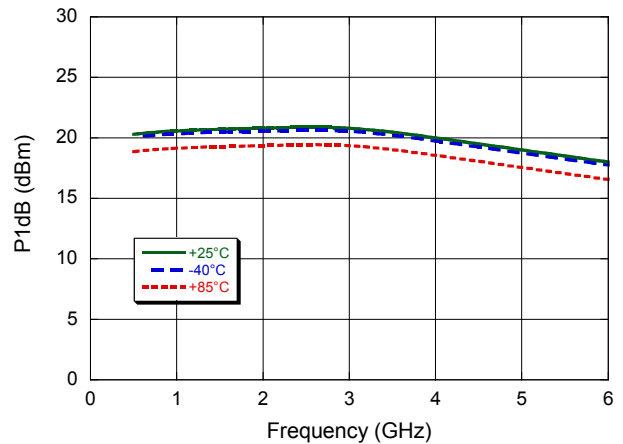

## Low Noise Amplifier 700 MHz - 6 GHz

Rev. V1

### Typical Performance Curves @ 3 V / 30 mA, 3 V / 50 mA, 5V / 70 mA, $Z_0 = 50 \Omega$

**Gain**

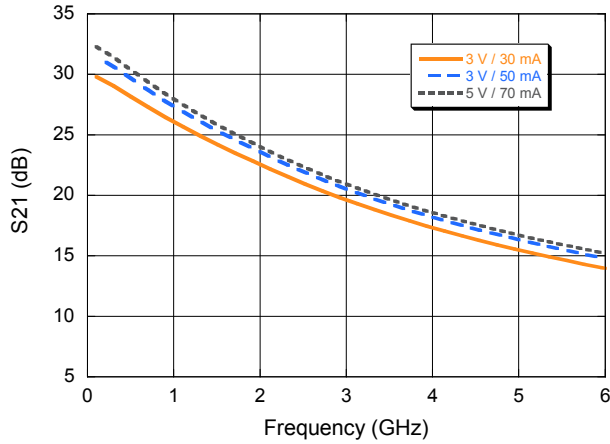

**Noise Figure**

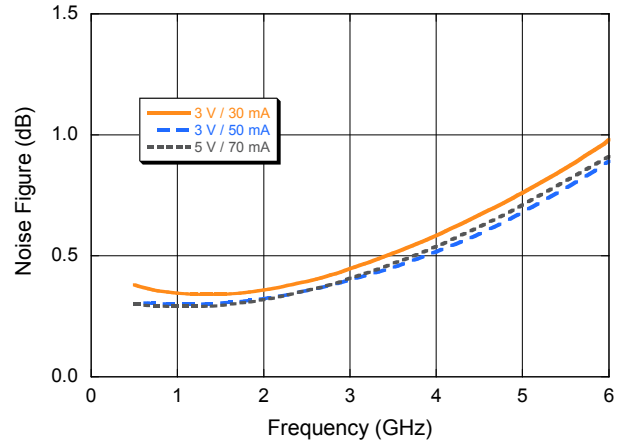

**Input Return Loss**

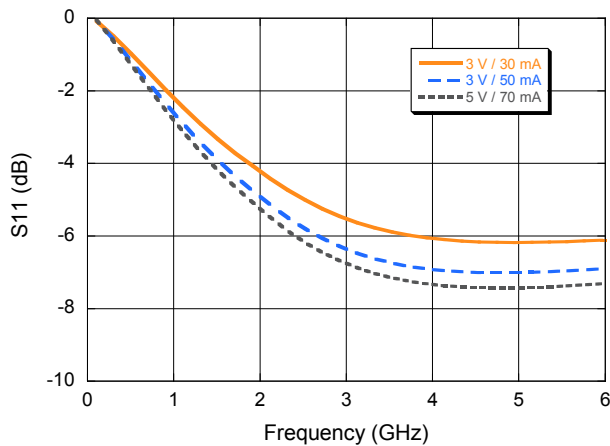

**Output Return Loss**

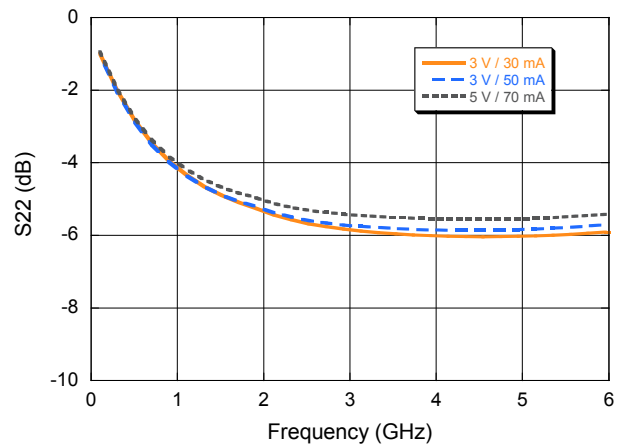

**OIP3**

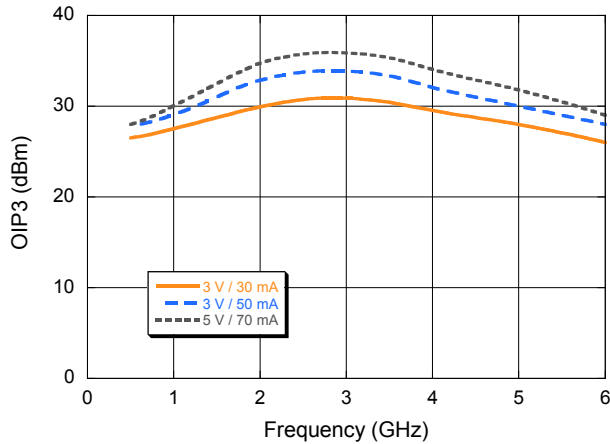

**P1dB**

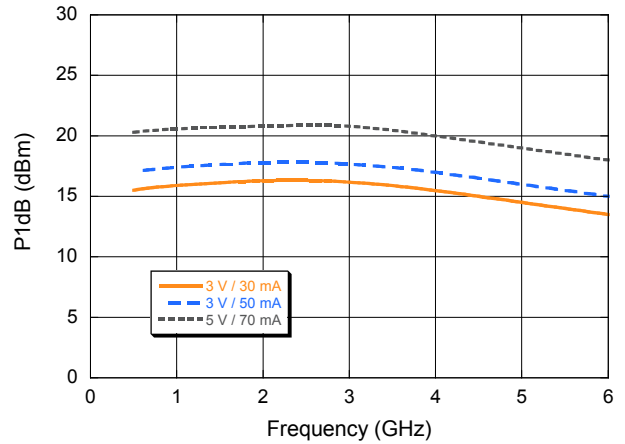





## 2.3 - 2.7 GHz Application Section

The MAAL-011078 is designed to work as a low noise gain block over a wide range of frequencies in a 50  $\Omega$  environment.

Input and output can be tuned to improve return loss over a specific frequency band.

The evaluation board shown has been designed for tuning flexibility. The parts list on page 10 details the components needed to tune the MAAL-011078 for operation from 2.3 – 2.7 GHz. R1 or R2 may be used as R<sub>BIAS</sub> according to the biasing option chosen.

### Evaluation Board, 2.3 - 2.7 GHz

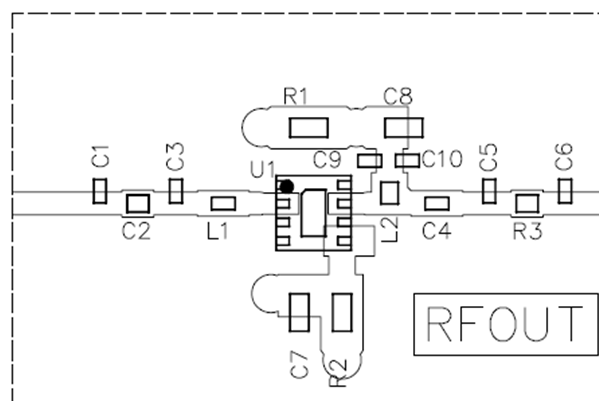
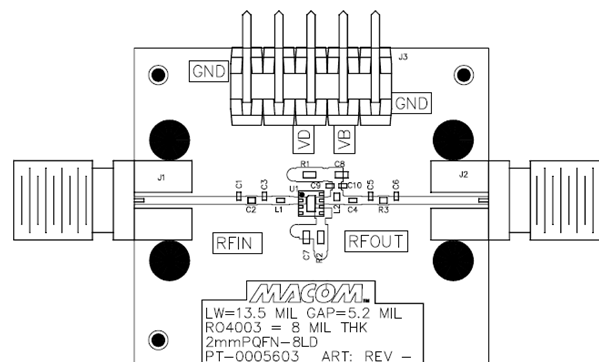

### Schematic, 2.3 - 2.7 GHz

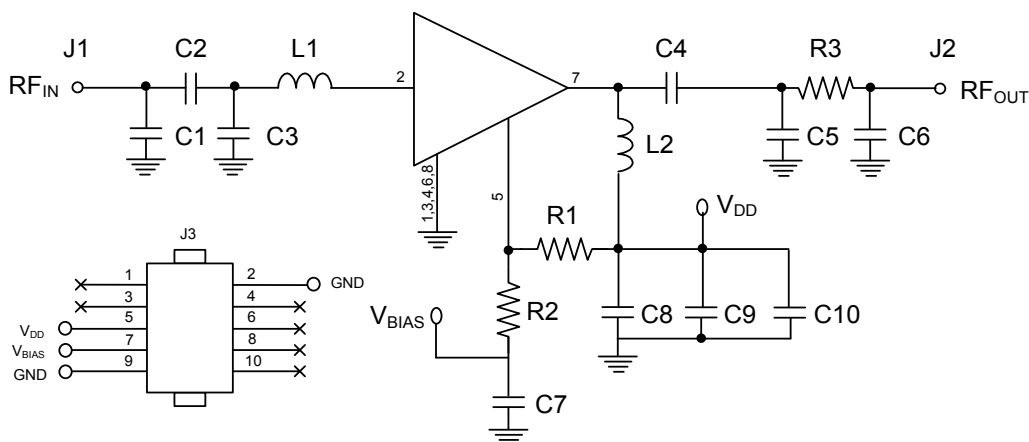

## 2.3 - 2.7 GHz Application Section

### Parts List, 2.3 - 2.7 GHz

Component	Value	Size	Manufacturer	Manufacturer Part #
C1	—	0201	—	—
C2	10 pF	0201	Murata	GJM0336C1E100JB01
C3	0.7 pF	0201	Murata	GJM0335C1ER70WB0
C4	1.8 pF	0201	Murata	GJM0335C1E1R8BB01
C5	0.4 pF	0201	Murata	GJM0335C1ER40WB01
C6	—	0201	—	—
C7	—	0402	—	—
C8	0.1 $\mu$ F	0402	—	—
C9, C10	47 pF	0201	—	—
L1	2.5 nH	0201	Coilcraft	0201DS-2N5XJL
L2	2.7 nH	0201	Murata	LQP03TN2N7C02
R1	470 $\Omega$	0402	—	—
R2	—	0402	—	—
R3	0 $\Omega$	0201	—	—

## Low Noise Amplifier 700 MHz - 6 GHz

Rev. V1

Electrical Specifications: Freq = 2.6 GHz<sup>11,12</sup>, V<sub>DD</sub> = 3 V, +25°C, Z<sub>0</sub> = 50 Ω

Parameter	Test Conditions	Units	Min.	Typ.	Max.
Noise Figure	-	dB	—	0.7	—
Gain	-	dB	—	23	—
Input Return Loss	-	dB	—	16	—
Output Return Loss	-	dB	—	10	—
Output IP3	P <sub>IN</sub> = -22 dBm, tones 11 MHz apart	dBm	—	33.4	—
Total Current	I <sub>DQ</sub> = I <sub>DD</sub> + I <sub>BIAS</sub>	mA	—	50	—

11. Typical performance of the evaluation module with exact components shown on the 2.3 - 2.7 GHz parts list.

12. Typical measured data includes evaluation board and connector losses.

### Typical Performance Curves: Broadband performance (2.3 - 2.7 GHz evaluation board)

**Gain**

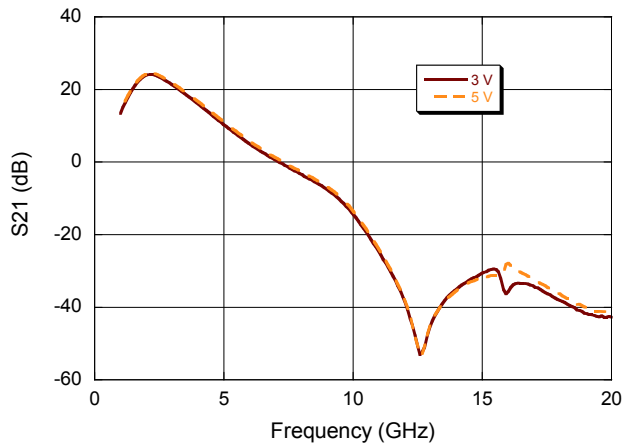

**Reverse Isolation**

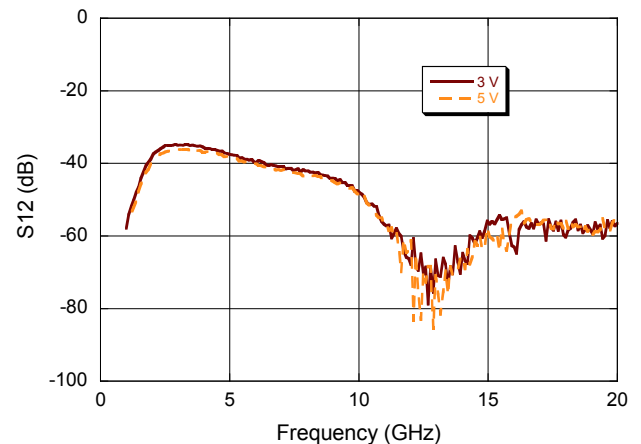

**Input Return Loss**

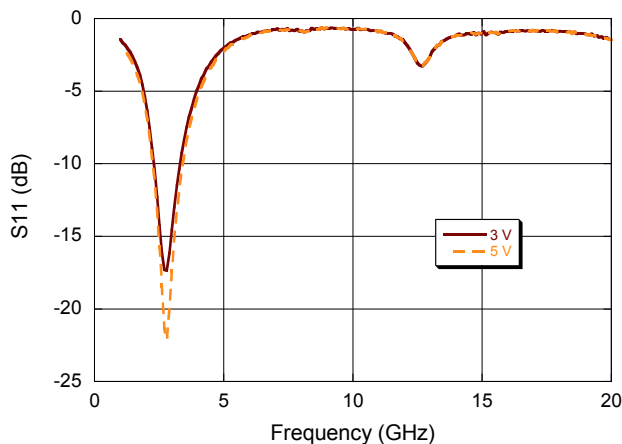

**Output Return Loss**

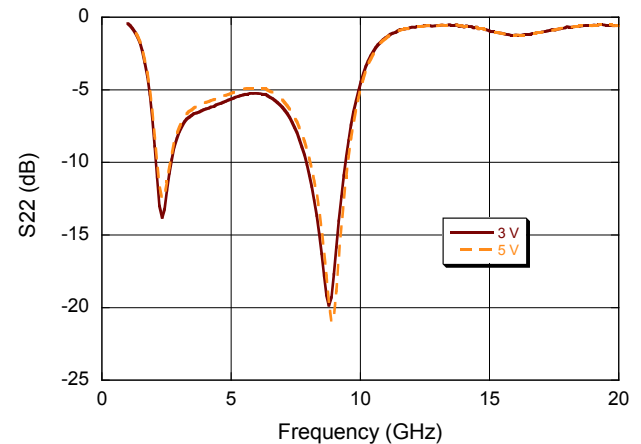

## Low Noise Amplifier 700 MHz - 6 GHz

Rev. V1

### Typical Performance Curves: Freq = 2.3 - 2.7 GHz, $Z_0 = 50 \Omega$

**Gain**

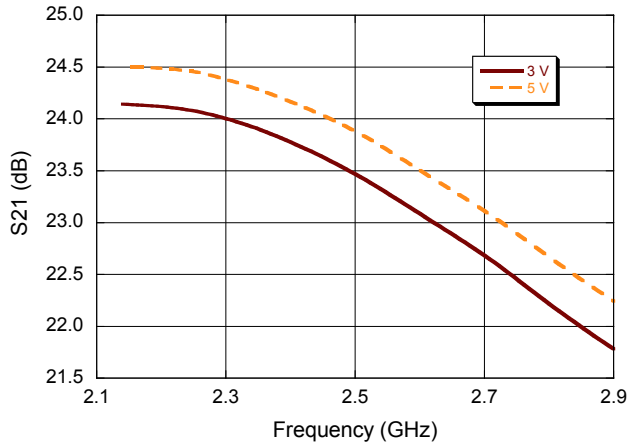

**Noise Figure**

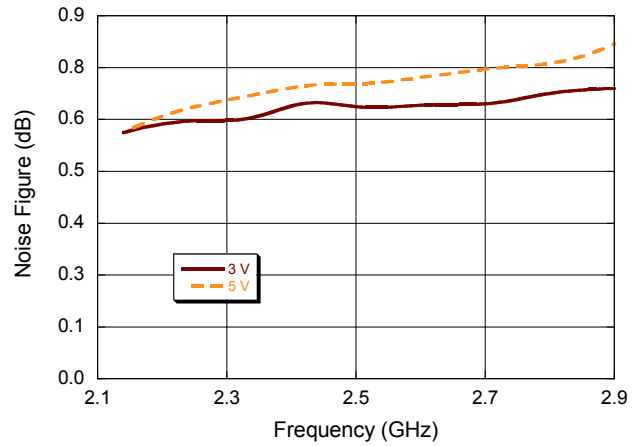

**Input Return Loss**

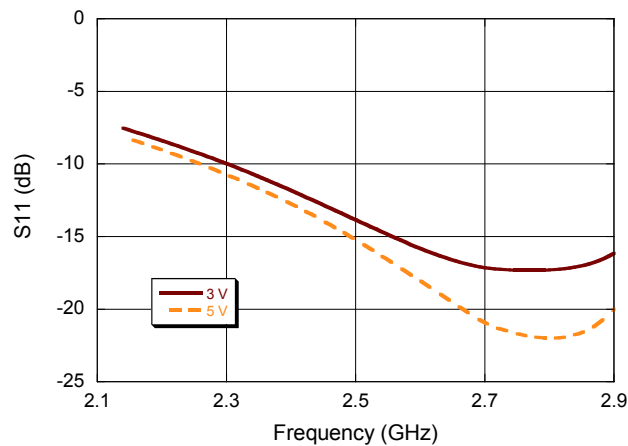

**Output Return Loss**

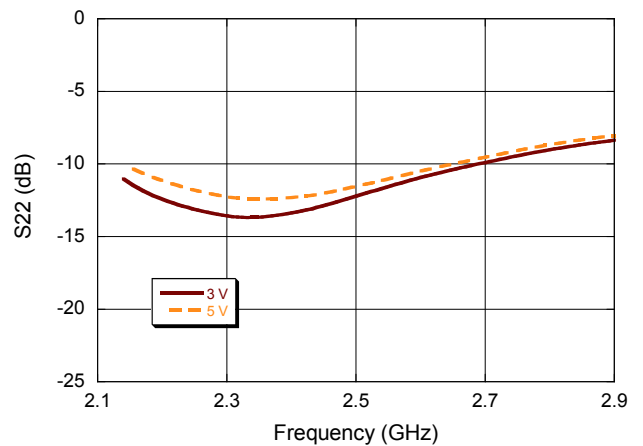

**Reverse Isolation**

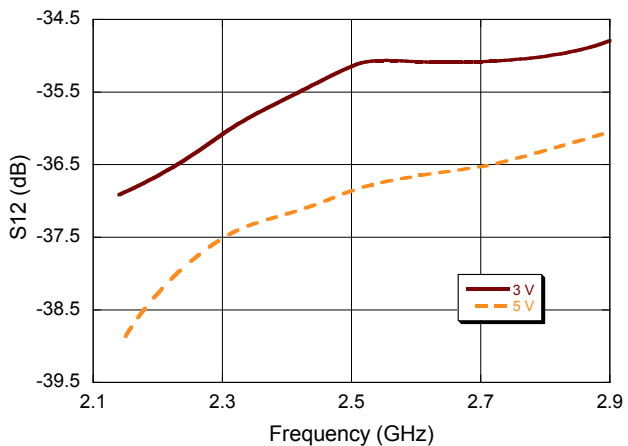

**OIP3**

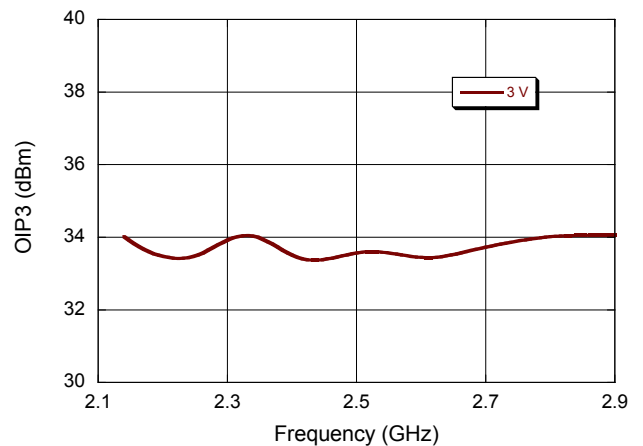

Компания «Океан Электроники» предлагает заключение долгосрочных отношений при поставках импортных электронных компонентов на взаимовыгодных условиях!

Наши преимущества:

- Поставка оригинальных импортных электронных компонентов напрямую с производств Америки, Европы и Азии, а так же с крупнейших складов мира;
- Широкая линейка поставок активных и пассивных импортных электронных компонентов (более 30 млн. наименований);
- Поставка сложных, дефицитных, либо снятых с производства позиций;
- Оперативные сроки поставки под заказ (от 5 рабочих дней);
- Экспресс доставка в любую точку России;
- Помощь Конструкторского Отдела и консультации квалифицированных инженеров;
- Техническая поддержка проекта, помощь в подборе аналогов, поставка прототипов;
- Поставка электронных компонентов под контролем ВП;
- Система менеджмента качества сертифицирована по Международному стандарту ISO 9001;
- При необходимости вся продукция военного и аэрокосмического назначения проходит испытания и сертификацию в лаборатории (по согласованию с заказчиком);
- Поставка специализированных компонентов военного и аэрокосмического уровня качества (Xilinx, Altera, Analog Devices, Intersil, Interpoint, Microsemi, Actel, Aeroflex, Peregrine, VPT, Syfer, Eurofarad, Texas Instruments, MS Kennedy, Miteq, Cobham, E2V, MA-COM, Hittite, Mini-Circuits, General Dynamics и др.);

Компания «Океан Электроники» является официальным дистрибьютором и эксклюзивным представителем в России одного из крупнейших производителей разъемов военного и аэрокосмического назначения «JONHON», а так же официальным дистрибьютором и эксклюзивным представителем в России производителя высокотехнологичных и надежных решений для передачи СВЧ сигналов «FORSTAR».



## JONHON

«JONHON» (основан в 1970 г.)

Разъемы специального, военного и аэрокосмического назначения:

(Применяются в военной, авиационной, аэрокосмической, морской, железнодорожной, горно- и нефтедобывающей отраслях промышленности)

«FORSTAR» (основан в 1998 г.)

ВЧ соединители, коаксиальные кабели, кабельные сборки и микроволновые компоненты:

(Применяются в телекоммуникациях гражданского и специального назначения, в средствах связи, РЛС, а так же военной, авиационной и аэрокосмической отраслях промышленности).



Телефон: 8 (812) 309-75-97 (многоканальный)

Факс: 8 (812) 320-03-32

Электронная почта: [ocean@oceanchips.ru](mailto:ocean@oceanchips.ru)

Web: <http://oceanchips.ru/>

Адрес: 198099, г. Санкт-Петербург, ул. Калинина, д. 2, корп. 4, лит. А