

Click [here](#) for production status of specific part numbers.

## MAX33250E/ MAX33251E

# 600V Isolated 2Tx/2Rx and 1Tx/1Rx RS-232 Transceiver with $\pm 15\text{kV}$ ESD and Integrated Capacitors

## General Description

The MAX33250E and MAX33251E are isolated 2Tx/2Rx and 1Tx/1Rx RS-232 transceivers, respectively, with a galvanic isolation of  $600\text{V}_{\text{RMS}}$  (60sec) between the logic UART side and field side. The isolation barrier protects the logic UART side from electrical transient strikes from the field side. It also breaks ground loops and large differences in ground potentials between the two sides that can potentially corrupt the receiving and sending of data. The MAX33250E and MAX33251E conform to the EIA/TIA-232E standard and operate at data rates up to 1Mbps.

The isolated RS-232 transceivers have integrated charge pumps and an inverter to eliminate the need for a high positive and negative voltage supply. Both devices also have integrated charge pump and inverter capacitors to help further reduce PCB space. The supply pin  $V_{\text{CCA}}$  on the UART logic side operates from a dual voltage supply from +3V to +5.5V.  $V_{\text{CCB}}$  also operates from +3V to +5.5V, simplifying power requirements and enabling level translation between the two voltages. The transmitters and receivers on the field side of these devices are rated for  $\pm 15\text{kV}$  of ESD HBM protection, suitable for applications where RS-232 cables are frequently worked on.

Both are available in a 12-pin, 6mm x 6mm LGA package and operate over the  $-40^{\circ}\text{C}$  to  $+85^{\circ}\text{C}$  temperature range.

## Applications

- Diagnostics Equipment
- POS Systems
- Industrial Equipment
- GPS Equipment
- Communication Systems
- Medical Equipment

## Benefits and Features

- High Integration Saves Space and Simplifies Designs
  - Integrated Charge Pumps and Inverter Eliminates Extra Power Supplies
  - Four Internal Capacitors Saves PCB Space
  - Integrated Isolator Saves Up to 63% Versus a Discrete Solution
- Integrated Protection for Robust Communications
  - $600\text{V}_{\text{RMS}}$  Withstand Isolation Voltage for 60 Seconds ( $V_{\text{ISO}}$ )
  - $200\text{V}_{\text{RMS}}$  Working Voltage for >50 years ( $V_{\text{IOWM}}$ )
  - Integrated  $\pm 15\text{kV}$  ESD Human Body Model (HBM)

**Ordering Information** appears at end of data sheet.

## Simplified Block Diagram

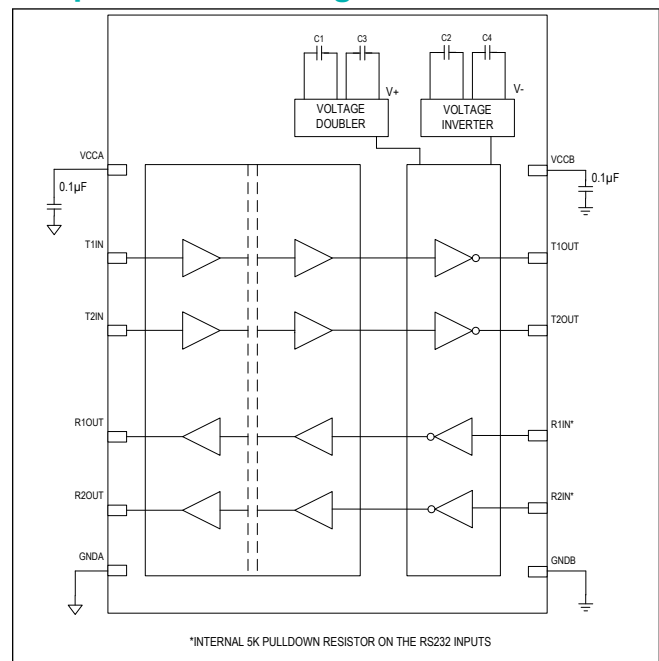

## Absolute Maximum Ratings

$V_{CCA}$ to GNDA .....	-0.3V to +6V	Side A ( $V_{CCA}$ , T1IN, T2IN, R1OUT, R2OUT) to GNDA ESD $\pm 2\text{kV}$
$V_{CCB}$ to GNDB .....	-0.3V to +6V	Side B ( $V_{CCB}$ ) to GNDB ESD .....
T_IN to GNDA .....	-0.3V to +6V	Side B (T1OUT, T2OUT, R1IN, R2IN) to GNDB ESD HBM $\pm 15\text{kV}$
T_OUT to GNDB .....	$\pm 13.2\text{V}$	Continuous Power Dissipation (Single Layer Board) ( $T_A = +70^\circ\text{C}$ , derate $10\text{mW}/^\circ\text{C}$ above $+70^\circ\text{C}$ .) .....
R_IN to GNDB .....	$\pm 25\text{V}$	510mW
R_OUT to GNDA .....	-0.3V to +6V	Continuous Power Dissipation (Multilayer Board) ( $T_A = +70^\circ\text{C}$ , derate $10\text{mW}/^\circ\text{C}$ above $+70^\circ\text{C}$ .) .....
Short-Circuit Duration (T_OUT to GNDB) .....	Continuous	700mW
Short-Circuit Duration (R_OUT to GNDA) .....	Continuous	Operating Temperature Range .....
		$-40^\circ\text{C}$ to $+85^\circ\text{C}$

Stresses beyond those listed under "Absolute Maximum Ratings" may cause permanent damage to the device. These are stress ratings only, and functional operation of the device at these or any other conditions beyond those indicated in the operational sections of the specifications is not implied. Exposure to absolute maximum rating conditions for extended periods may affect device reliability.

## Package Information

### LGA-12

Package Code	L1266M+1
Outline Number	<a href="#">21-100222</a>
Land Pattern Number	<a href="#">90-100078</a>
<b>Thermal Resistance, Single-Layer Board:</b>	
Junction-to-Ambient ( $\theta_{JA}$ )	$157^\circ\text{C}/\text{W}$
Junction-to-Case Thermal Resistance ( $\theta_{JC}$ )	$31^\circ\text{C}/\text{W}$
<b>Thermal Resistance, Four-Layer Board:</b>	
Junction-to-Ambient ( $\theta_{JA}$ )	$115^\circ\text{C}/\text{W}$
Junction-to-Case Thermal Resistance ( $\theta_{JC}$ )	$31^\circ\text{C}/\text{W}$

For the latest package outline information and land patterns (footprints), go to [www.maximintegrated.com/packages](http://www.maximintegrated.com/packages). Note that a "+", "#", or "-" in the package code indicates RoHS status only. Package drawings may show a different suffix character, but the drawing pertains to the package regardless of RoHS status.

Package thermal resistances were obtained using the method described in JEDEC specification JESD51-7, using a four-layer board. For detailed information on package thermal considerations, refer to [www.maximintegrated.com/thermal-tutorial](http://www.maximintegrated.com/thermal-tutorial).

## Electrical Characteristics

( $V_{CCA} - V_{GNDA} = 3.0\text{V}$  to  $5.5\text{V}$ ,  $V_{CCB} - V_{GNDB} = 3.0\text{V}$  to  $5.5\text{V}$ ,  $T_A = T_{MIN}$  to  $T_{MAX}$ , unless otherwise noted. Typical values are at  $V_{CCA} - V_{GNDA} = 3.3\text{V}$ ,  $V_{CCB} - V_{GNDB} = 3.3\text{V}$ ,  $V_{GNDA} = V_{GNDB}$ , and  $T_A = +25^\circ\text{C}$ . (Note 1), Limits are 100% tested at  $T_A = +25^\circ\text{C}$ . Limits over the operating temperature range and relevant supply voltage range are guaranteed by design and characterization. Specifications marked "GBD" are guaranteed by design and not production tested.)

PARAMETER	SYMBOL	CONDITIONS	MIN	TYP	MAX	UNITS
<b>POWER</b>						
Supply Voltage	$V_{CCA}, V_{CCB}$		3.0		5.5	V
Supply Current	$I_{CCA}$	$V_{CCA} = 5\text{V}$ , R_IN and T_IN idle			12	mA
		$V_{CCA} = 3.3\text{V}$ , R_IN and T_IN idle			10	
	$I_{CCB}$	$V_{CCB} = 5\text{V}$ , R_IN and T_IN idle, no load			12	
		$V_{CCB} = 3.3\text{V}$ , R_IN and T_IN idle, no load			10	
Undervoltage-Lockout Threshold	$V_{UVLO}$	$V_{CCA} - V_{GNDA}$ (Note 2)		2.0		V
Undervoltage-Lockout Hysteresis	$V_{UVLOHYS}$	$V_{CCA} - V_{GNDA}$ (Note 2)		0.1		V
<b>INPUT INTERFACE (T_IN, R_IN)</b>						
Input Low Voltage	$V_{IL}$	T_IN relative to GNDA			0.8	V
		R_IN relative to GNDB, $T_A = 25^\circ\text{C}$ , $V_{CC} = 3.3\text{V}$			0.6	
		R_IN relative to GNDB, $T_A = 25^\circ\text{C}$ , $V_{CC} = 5\text{V}$			0.8	
Input High Voltage	$V_{IH}$	T_IN relative to GNDA	$0.7 \times V_{CCA}$			V
		R_IN relative to GNDB, $V_{CCB} = 3.3\text{V}$ and $5\text{V}$ , $T_A = 25^\circ\text{C}$	2.4			
Transmitter Input Hysteresis		(T_IN)		0.5		V
Receiver Input Hysteresis		(R_IN)		0.5		V
Transmitter Input Leakage		(T_IN)			$\pm 1$	$\mu\text{A}$
Input Resistance (R_IN)		$T_A = 25^\circ\text{C}$	3	5	7	k $\Omega$
<b>RECEIVER OUTPUT INTERFACE (R_OUT)</b>						
Output Low Voltage	$V_{OL}$	R_OUT relative to GNDA, sink current = 4mA			0.8	V
Output High Voltage	$V_{OH}$	R_OUT relative to GNDA, source current = 4mA	$V_{CCA} - 0.4$			V
Output Short-Circuit Current					$\pm 110$	mA
<b>TRANSMITTER OUTPUT (T_OUT)</b>						
Output Voltage Swing		T_OUT loaded with 3k $\Omega$ to GNDB	$\pm 5$			V

**Electrical Characteristics (continued)**

( $V_{CCA} - V_{GNDA} = 3.0\text{V}$  to  $5.5\text{V}$ ,  $V_{CCB} - V_{GNDB} = 3.0\text{V}$  to  $5.5\text{V}$ ,  $T_A = T_{MIN}$  to  $T_{MAX}$ , unless otherwise noted. Typical values are at  $V_{CCA} - V_{GNDA} = 3.3\text{V}$ ,  $V_{CCB} - V_{GNDB} = 3.3\text{V}$ ,  $V_{GNDA} = V_{GNDB}$ , and  $T_A = +25^\circ\text{C}$ . (Note 1), Limits are 100% tested at  $T_A = +25^\circ\text{C}$ . Limits over the operating temperature range and relevant supply voltage range are guaranteed by design and characterization. Specifications marked "GBD" are guaranteed by design and not production tested.)

PARAMETER	SYMBOL	CONDITIONS	MIN	TYP	MAX	UNITS
Output Resistance		$V_{CCB} = 0\text{V}$ , transmitters = $\pm 2\text{V}$	300	10M		$\Omega$
Output Short-Circuit Current					$\pm 70$	mA
Output Leakage Current		$V_{CCB} = 0\text{V}$ , $V_{OUT} = \pm 12\text{V}$			$\pm 25$	$\mu\text{A}$
<b>ESD AND ISOLATION PROTECTION</b>						
ESD for R_IN, T_OUT		IEC 61000-4-2 Air Discharge		$\pm 12$		kV
		IEC 61000-4-2 Contact Discharge		$\pm 6$		
		ESD Human Body Model JEDEC JS-001-2014		$\pm 15$		
Isolation Voltage	$V_{ISO}$	t = 60s (Note 3)		600		$V_{RMS}$
Working Isolation Voltage	$V_{IOWM}$	> 50 years (Note 3)		200		$V_{RMS}$
<b>TIMING CHARACTERISTICS</b>						
Maximum Data Rate		$V_{CCB} = 5\text{V}$ , $R_L = 3\text{k}\Omega$ , $C_L = 1000\text{pF}$	1000			kbps
Receiver Propagation Delay	$t_{PHL}$ , $t_{PLH}$	R_IN to R_OUT, $C_L = 150\text{pF}$		0.15		$\mu\text{s}$
Transmitter Skew	$ t_{PHL} - t_{PLH} $ (Note 4)			35		ns
Receiver Skew	$ t_{PHL} - t_{PLH} $			60		ns
Transition-Region Slew Rate		$V_{CCA} = V_{CCB} = 3.3\text{V}$ , $T_A = +25^\circ\text{C}$ , $R_L = 3\text{k}$ to $7\text{k}$ , $C_L = 150\text{pF}$ to $1000\text{pF}$ , measured from $+3\text{V}$ to $-3\text{V}$ or $-3\text{V}$ to $+3\text{V}$	24		150	$\text{V}/\mu\text{s}$

**Note 1:** All units are production tested at  $T_A = 25^\circ\text{C}$ . Specifications over temperature are guaranteed by design. All voltages of side A are referenced to GNDA. All voltages of side B are referenced to GNDB.

**Note 2:** The undervoltage lockout threshold and hysteresis guarantee that the outputs are in a known state when the supply voltage dips.

**Note 3:** The isolation is guaranteed by design and not production tested.

**Note 4:** Transmitter skew is measured at the transmitter zero cross points.

Typical Operating Characteristics

( $V_{DD} = 5V$ ,  $V_L = 3.3V$ ,  $R_L = 60\Omega$ ,  $C_L = 15pF$ ,  $T_A = +25^\circ C$ , unless otherwise noted.)

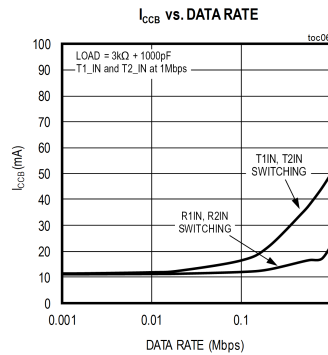
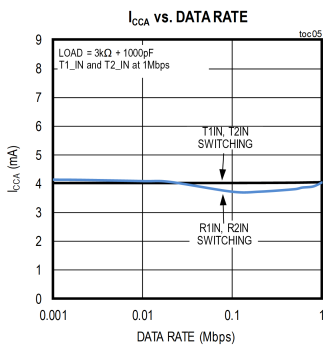
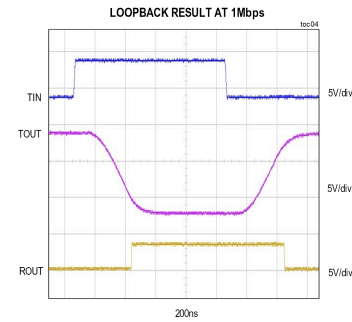
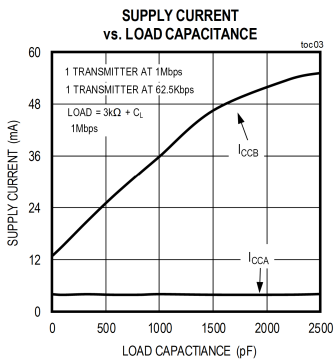
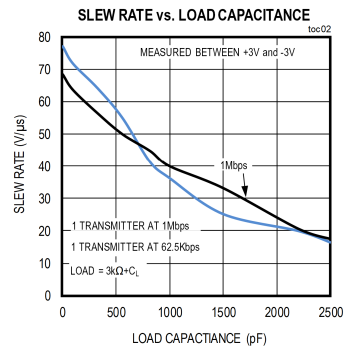
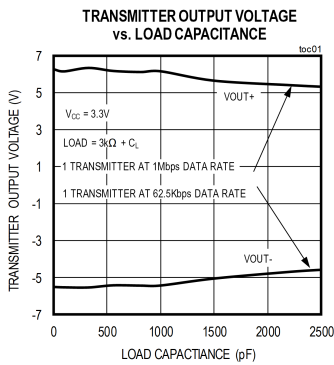

Typical Operating Characteristics (continued)

( $V_{DD} = 5V$ ,  $V_L = 3.3V$ ,  $R_L = 60\Omega$ ,  $C_L = 15pF$ ,  $T_A = +25^\circ C$ , unless otherwise noted.)

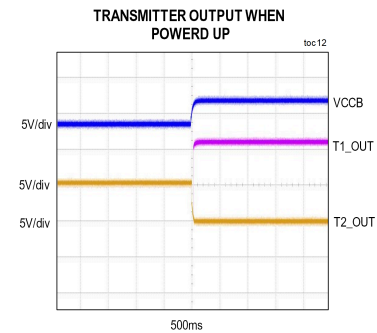
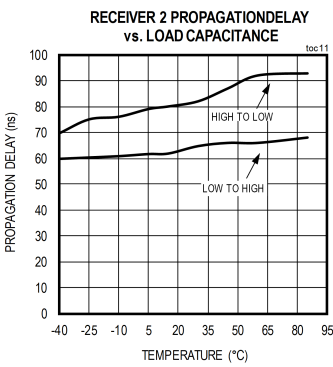
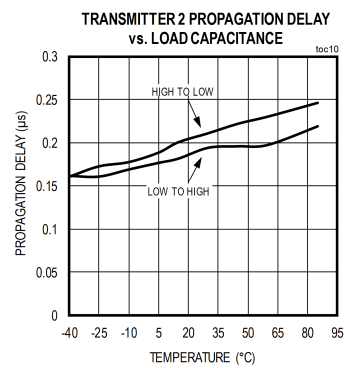
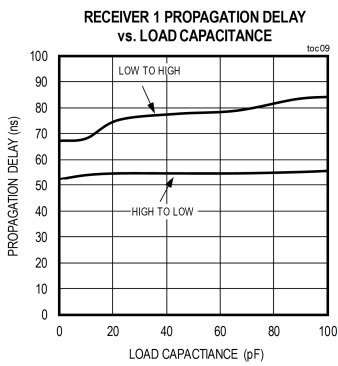
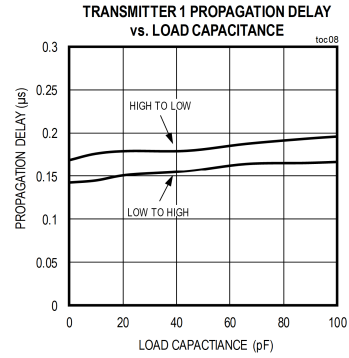
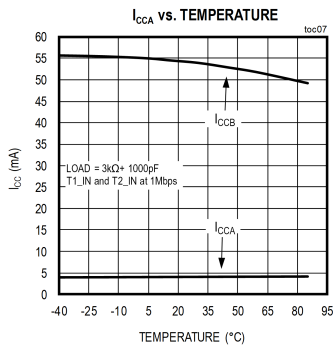

### Pin Configurations

#### MAX33250E

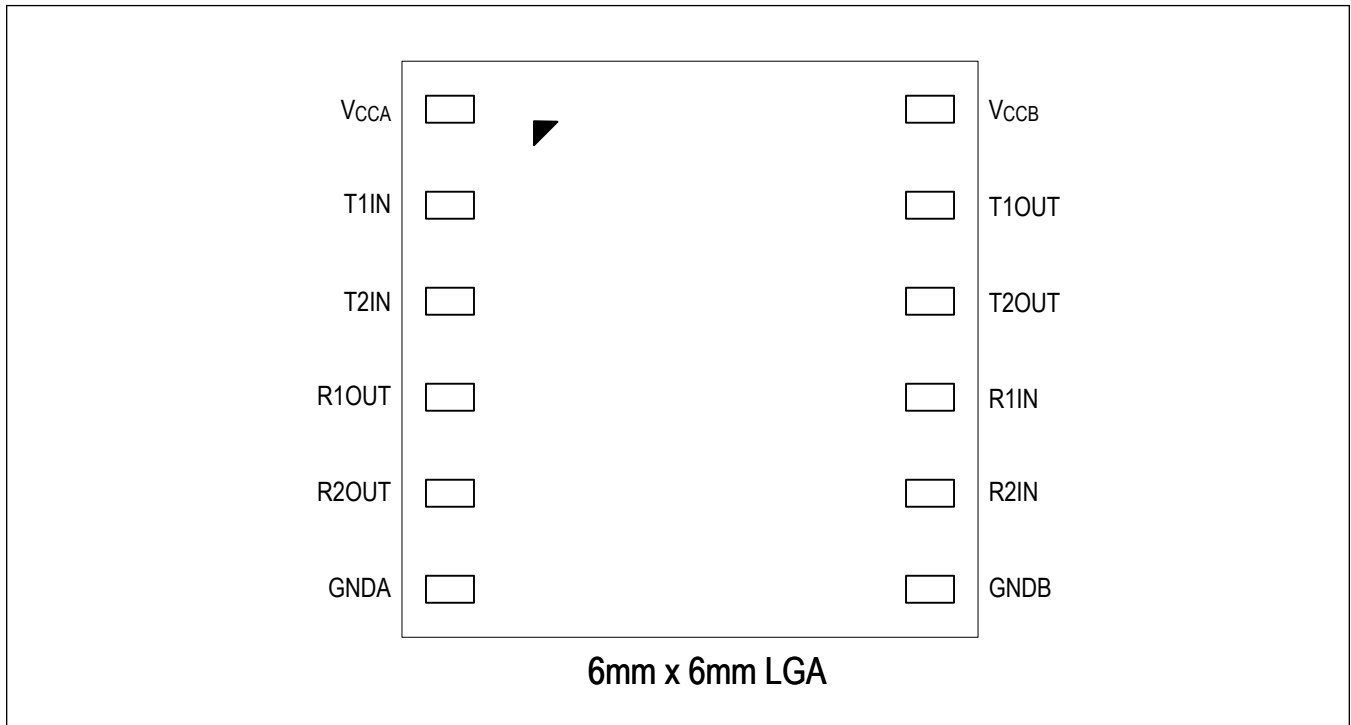

**MAX33251E**

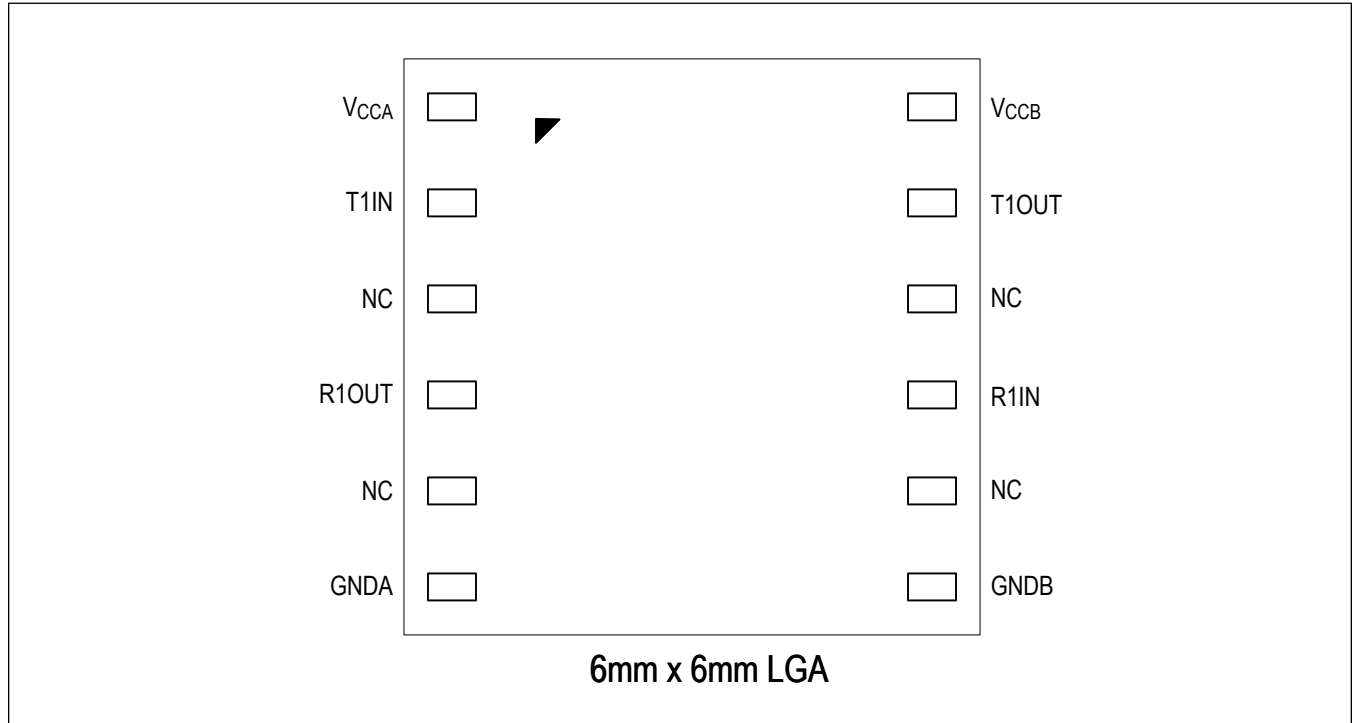

**Pin Description**

PIN		NAME	FUNCTION
MAX33250E	MAX33251E		
1	1	V <sub>CCA</sub>	Supply Voltage of Logic Side A. Bypass V <sub>CCA</sub> with a 0.1µF ceramic capacitor to GNDA
2	2	T1IN	TTL/CMOS Transmitter Input 1
3	---	T2IN	TTL/CMOS Transmitter Input 2
4	4	R1OUT	TTL/CMOS Receiver Output 1
5	---	R2OUT	TTL/CMOS Receiver Output 2
6	6	GNDA	Ground for Logic Side A
7	7	GNDB	Ground for Field Side B
8	---	R2IN	RS-232 Receiver Input 2
9	9	R1IN	RS-232 Receiver Input 1
10	---	T2OUT	RS-232 Transmitter Output 2
11	11	T1OUT	RS-232 Transmitter Output 1
12	12	V <sub>CCB</sub>	Supply Voltage of Logic Side B. Bypass V <sub>CCB</sub> with a 0.1µF ceramic capacitor to GNDB



## Detailed Description

The MAX33250E and MAX33251E are 1Mbps,  $600\text{V}_{\text{RMS}}$  isolated RS-232 transceivers. The MAX33250E has 2 transmitters and 2 receivers (2Tx/2Rx), and the MAX33251E has 1 transmitter and 1 receiver (1Tx/1Rx). The isolation is provided by Maxim's proprietary insulation material that can withstand  $600\text{V}_{\text{RMS}}$  for 60 seconds. The MAX33250E and MAX33251E conform to the EIA/TIA-232 standard and operates at data rates up to 1Mbps over the temperature range of  $-40^{\circ}\text{C}$  to  $85^{\circ}\text{C}$ .

## Digital Isolation

The MAX33250E and MAX33251E provide galvanic isolation and protection for digital signals from the local microcontroller's logic UART port (primary side) to the field lines (secondary side). A capacitive design is utilized where the insulation material for the isolation barrier is rated for  $600\text{V}_{\text{RMS}}$  withstand voltage ( $V_{\text{ISO}}$ ) for 60 seconds. The same material can also be exposed to a differential of  $200\text{V}_{\text{RMS}}$  of working voltage ( $V_{\text{IOWM}}$ ) for more than 50 years, providing longevity for many different types of end equipment. The isolation barrier also breaks ground loops and level translation for two different systems where it could potentially create inadvertent or misinterpret data signals.

## Dual Charge Pump Voltage Converter and Inverter

Both parts have internal RS-232 power supplies that consist of a regulated dual charge pump that provides output voltages of  $+5.5\text{V}$  (doubling charge pump) and  $-5.5\text{V}$  (inverting charge pump), over the  $+3.0\text{V}$  to  $+5.5\text{V}$  range. Each charge pump is internally connected to a pair of flying capacitors and a pair of reservoir capacitors to generate the internal  $V+$  and  $V-$  supplies, as shown in [Typical Application Diagram](#).

## Startup and Undervoltage Lockout

The  $V_{\text{CCA}}$  and  $V_{\text{CCB}}$  supplies are both internally monitored for undervoltage conditions. Undervoltage events can occur during power-up, power-down, or during normal operation due to a dip in either power supply line. When an undervoltage event is detected on either of the supplies, all outputs on both sides are automatically controlled, regardless of the status of the inputs.

**Table 1. Output Control Truth Table**

INPUTS	$V_{\text{CCA}}$	$V_{\text{CCB}}$	RxOUT	TxOUT
RxIN = 1	Undervoltage	Powered	High	---
RxIN = 0	Undervoltage	Powered	Follows $V_{\text{CCA}}$	---
TxIN = 1	Undervoltage	Powered	---	Low
TxIN = 0	Undervoltage	Powered	---	Low
RxIN = 1	Powered	Undervoltage	High	---
RxIN = 0	Powered	Undervoltage	High	---
TxIN = 1	Powered	Undervoltage	---	*Low
TxIN = 0	Powered	Undervoltage	---	*Low

\*TxOUT will be out of compliance with the RS-232 specification as  $V_{\text{CCB}}$  falls below  $2.9\text{V}$ .

**RS-232 Transmitters**

The transmitters are inverting level translators that convert CMOS-logic levels from the UART or equivalent output port to +5V EIA/TIA-232 levels. The two devices guarantee 1Mbps with worst-case loads of  $3\text{k}\Omega$  in parallel with  $1000\text{pF}$ , providing compatibility with PC-to-PC communication software. Transmitters can be paralleled to drive multiple receivers.

**RS-232 Receivers**

The receivers convert RS-232 signals to CMOS-logic output levels to the UART or equivalent input port. The devices feature inverting outputs that always remain active.

**Power Supply Decoupling**

To reduce ripple and the chance of introducing data errors, bypass  $V_{CCA}$  and  $V_{CCB}$  with  $0.1\mu\text{F}$  ceramic capacitors to GNDA and GNDB, respectively. Place the bypass capacitors as close to the power-supply input pins as possible.

## Insulation and Safety Characteristics

PARAMETER	SYMBOL	CONDITIONS	VALUE	UNIT
<b>IEC INSULATION AND SAFETY RELATED FOR SPECIFICATIONS</b>				
External Tracking (Creepage)	CPG	IEC 60664-1	4.4	mm
External Air Gap (Clearance)	CLR	IEC 60664-1	4.4	mm
Minimum Internal Gap		Insulation Thickness	0.0026	mm
Tracking Resistance (Comparative Tracking Index)	CTI	IEC 112/VDE 030 Part 1	175	V
Insulation Resistance Across Barrier	$R_{ISO}$		1	$G\Omega$
Capacitance Across Isolation Barrier	$C_{IO}$	$f = 1\text{MHz}$	12	pF
<b>VDE IEC INSULATION CHARACTERISTICS</b>				
Surge Isolation Voltage	$V_{IOSM}$	IEC 60747-17, section 5.3.1.6 and 5.4.6 for basic insulation	1	$\text{kV}_{PEAK}$
Repetitive Peak Isolation Voltage	$V_{IORM}$	IEC 60747-17, section 5.3.1.3	282	$\text{kV}_{PEAK}$
Rated Transient Isolation Voltage	$V_{IOTM}$	IEC 60747-17, section 5.3.1.4	850	$\text{kV}_{PEAK}$
Safety Limiting Temperature	$T_S$	IEC 60747-17, section 7.2.1	150	$^{\circ}\text{C}$
Safety Limiting Side A Power Dissipation	$P_{SA}$	IEC 60747-17, section 7.2.1	0.75	W
Safety Limiting Side B Power Dissipation	$P_{SB}$	IEC 60747-17, section 7.2.1	0.75	W
Apparent Charge Method	$q_{pd}$	IEC 60747-17, section 7.4 method a and b	5	pC
Overvoltage Category		IEC 60664-1, single or three phase 50V DC or AC	I,II	—
Overvoltage Category		IEC 60664-1, single or three phase 100V DC or AC	I	—
Climatic Category			40/125/21	—
Pollution Degree		DIN VDE 0110	2	—

Typical Application Circuit

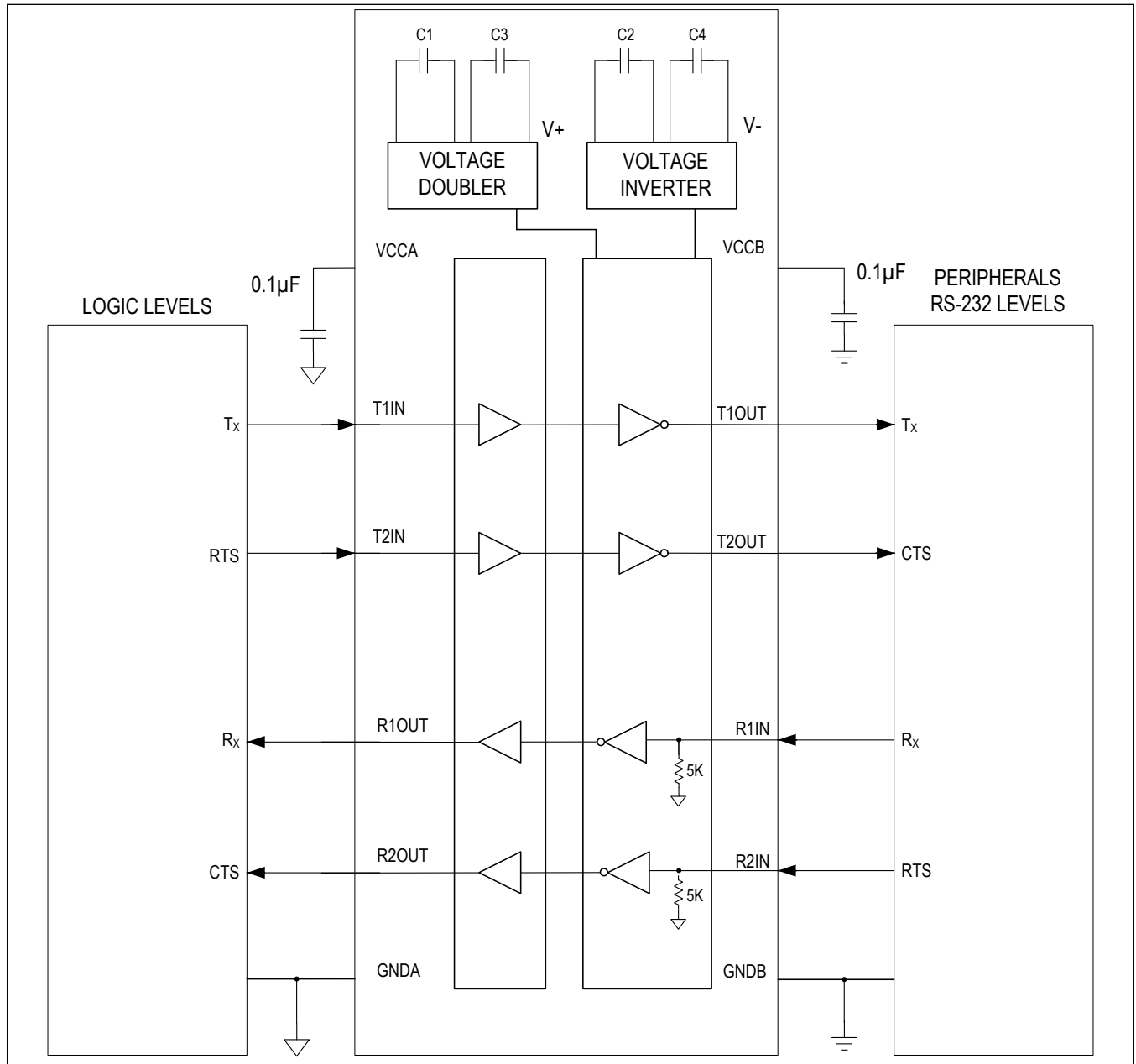

MAX33250E/MAX33251E

600V Isolated 2Tx/2Rx and 1Tx/1Rx RS-232  
Transceiver with  $\pm 15\text{kV}$  ESD  
and Integrated Capacitors

## Ordering Information

PART NUMBER	TEMPERATURE RANGE	CHANNEL-CONFIGURATION	DATA RATE	PIN-PACKAGE
MAX33250EELC+	-40°C to +85°C	2 Transmitters, 2 Receivers	1Mbps	12 (6mm x 6mm) LGA
MAX33251EELC+	-40°C to +85°C	1 Transmitter, 1 Receiver	1Mbps	12 (6mm x 6mm) LGA

+Denotes a lead(Pb)-free/RoHS-compliant package.

T = Tape-and-reel.

MAX33250E/MAX33251E

600V Isolated 2Tx/2Rx and 1Tx/1Rx RS-232  
Transceiver with  $\pm 15\text{kV}$  ESD  
and Integrated Capacitors

## Revision History

REVISION NUMBER	REVISION DATE	DESCRIPTION	PAGES CHANGED
0	9/18	Initial release	—
1	11/18	Updated <i>Ordering Information</i>	13

For pricing, delivery, and ordering information, please visit Maxim Integrated's online storefront at <https://www.maximintegrated.com/en/storefront/storefront.html>.

*Maxim Integrated cannot assume responsibility for use of any circuitry other than circuitry entirely embodied in a Maxim Integrated product. No circuit patent licenses are implied. Maxim Integrated reserves the right to change the circuitry and specifications without notice at any time. The parametric values (min and max limits) shown in the Electrical Characteristics table are guaranteed. Other parametric values quoted in this data sheet are provided for guidance.*

Компания «Океан Электроники» предлагает заключение долгосрочных отношений при поставках импортных электронных компонентов на взаимовыгодных условиях!

Наши преимущества:

- Поставка оригинальных импортных электронных компонентов напрямую с производств Америки, Европы и Азии, а так же с крупнейших складов мира;
- Широкая линейка поставок активных и пассивных импортных электронных компонентов (более 30 млн. наименований);
- Поставка сложных, дефицитных, либо снятых с производства позиций;
- Оперативные сроки поставки под заказ (от 5 рабочих дней);
- Экспресс доставка в любую точку России;
- Помощь Конструкторского Отдела и консультации квалифицированных инженеров;
- Техническая поддержка проекта, помощь в подборе аналогов, поставка прототипов;
- Поставка электронных компонентов под контролем ВП;
- Система менеджмента качества сертифицирована по Международному стандарту ISO 9001;
- При необходимости вся продукция военного и аэрокосмического назначения проходит испытания и сертификацию в лаборатории (по согласованию с заказчиком);
- Поставка специализированных компонентов военного и аэрокосмического уровня качества (Xilinx, Altera, Analog Devices, Intersil, Interpoint, Microsemi, Actel, Aeroflex, Peregrine, VPT, Syfer, Eurofarad, Texas Instruments, MS Kennedy, Miteq, Cobham, E2V, MA-COM, Hittite, Mini-Circuits, General Dynamics и др.);

Компания «Океан Электроники» является официальным дистрибьютором и эксклюзивным представителем в России одного из крупнейших производителей разъемов военного и аэрокосмического назначения «JONHON», а так же официальным дистрибьютором и эксклюзивным представителем в России производителя высокотехнологичных и надежных решений для передачи СВЧ сигналов «FORSTAR».



## JONHON

«JONHON» (основан в 1970 г.)

Разъемы специального, военного и аэрокосмического назначения:

(Применяются в военной, авиационной, аэрокосмической, морской, железнодорожной, горно- и нефтедобывающей отраслях промышленности)

«FORSTAR» (основан в 1998 г.)

ВЧ соединители, коаксиальные кабели,  
кабельные сборки и микроволновые компоненты:

(Применяются в телекоммуникациях гражданского и специального назначения, в средствах связи, РЛС, а так же военной, авиационной и аэрокосмической отраслях промышленности).



Телефон: 8 (812) 309-75-97 (многоканальный)

Факс: 8 (812) 320-03-32

Электронная почта: [ocean@oceanchips.ru](mailto:ocean@oceanchips.ru)

Web: <http://oceanchips.ru/>

Адрес: 198099, г. Санкт-Петербург, ул. Калинина, д. 2, корп. 4, лит. А