

## ISL32172E, ISL32272E, ISL32174E, ISL32179E

QUAD, ±16.5kV ESD Protected, 3.0V to 5.5V, Low Power, RS-422 Transmitters

FN6824  
Rev 4.01  
Mar 19, 2020

The [ISL32172E](#), [ISL32272E](#), [ISL32174E](#), and [ISL32179E](#) are ±16.5kV IEC61000-4-2 ESD protected, 3.0V to 5.5V powered, QUAD transmitters for balanced communication using the RS-422 standard. These drivers have very low output leakage currents (±10µA), so they present a low load to the RS-422 bus.

The driver (Tx) outputs are tri-statable and incorporate a hot plug feature to keep them disabled during power-up and power-down. The ISL32172E and ISL32272E have a common EN/ $\overline{\text{EN}}$ , the ISL32174E has a two channel EN12/EN34, and the ISL32179E has a versatile combination of individual and group channel enables (see [Table 1](#)).

Only the ISL32179E driver can be slew-rate limited, and only at the data rate of 0.46Mbps. Drivers on the other versions are not limited, so they can achieve 10Mbps or 32Mbps data rates. All versions are offered in industrial and extended industrial (-40°C to +125°C) temperature ranges.

The ISL32179E's QFN package has a 50% smaller footprint compared to the TSSOP. The ISL32179E also features a logic supply pin ( $V_L$ ) that sets the switching points of the enable and DI inputs to be compatible with a lower supply voltage in mixed voltage systems. Two speed select pins allow the ISL32179E to be configured for 460kbps, 10Mbps, or 32Mbps data rates. Individual channel and group enable pins increase the ISL32179E's flexibility.

### Related Literature

For a full list of related documents, visit our website:

- [ISL32172E](#), [ISL32272E](#), [ISL32174E](#), and [ISL32179E](#) device pages

### Features

- IEC61000 ESD protection on RS-422 outputs . . . . ±16.5kV
  - Class 3 ESD level on all other pins . . . . .12kV HBM
  - High machine model ESD level on all pins . . . . . 700V
- Wide supply range . . . . . 3.0V to 5.5V
- Specified for +125°C operation
- Available in industry standard pinouts (ISL32172E, ISL32272E, ISL32174E) or in a space saving QFN (ISL32179E) with added features
- Logic supply pin ( $V_L$ ) eases operation in mixed supply systems (ISL32179E only)
- User-selectable data rate (ISL32179E only)
- Hot plug Tx outputs remain tri-stated during power-up and power-down
- Low Tx leakage allows > 256 devices on the bus
- High data rates. . . . . up to 32Mbps
- Low quiescent supply current. . . . . 0.8mA (maximum)
  - Low shutdown supply current. . . . . 60µA
- Current limiting and thermal shutdown for driver overload protection
- Tri-statable Tx outputs
- 5V tolerant logic inputs when  $V_{CC} \leq 5V$
- Pb-free (RoHS compliant)

### Applications

- Telecom equipment
- Motor controllers/encoders
- Programmable logic controllers
- Industrial/process control networks

TABLE 1. SUMMARY OF FEATURES

PART NUMBER	FUNCTION	DATA RATE (Mbps)	SLEW RATE LIMITED?	HOT PLUG?	$V_L$ PIN?	TX ENABLE TYPE	QUIESCENT $I_{CC}$ (mA)	LOW POWER SHUTDOWN?	PIN COUNT
ISL32172E	4 Tx	32	NO	YES	NO	EN, $\overline{\text{EN}}$	<1	NO	16
ISL32272E	4 Tx	10	NO	YES	NO	EN, $\overline{\text{EN}}$	<1	NO	16
ISL32174E	4 Tx	32	NO	YES	NO	EN12, EN34	<1	NO	16
ISL32179E	4 Tx	32, 10, 0.46	SELECTABLE	YES	YES	Individual and group enables	<1	YES	24

## Typical Operating Circuits (1 of 4 Channels Shown)

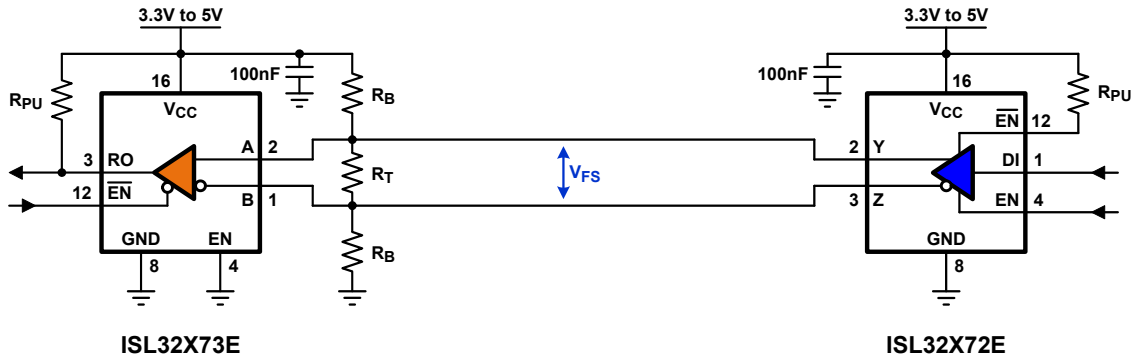

FIGURE 1. NETWORK USING GROUP ENABLES

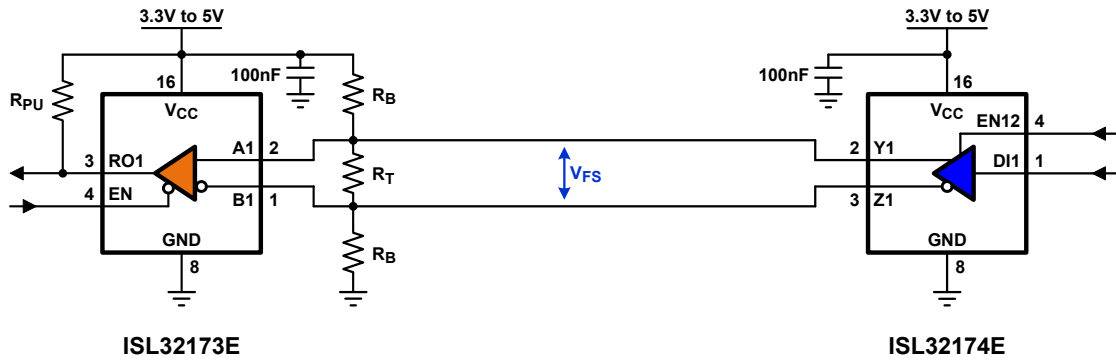
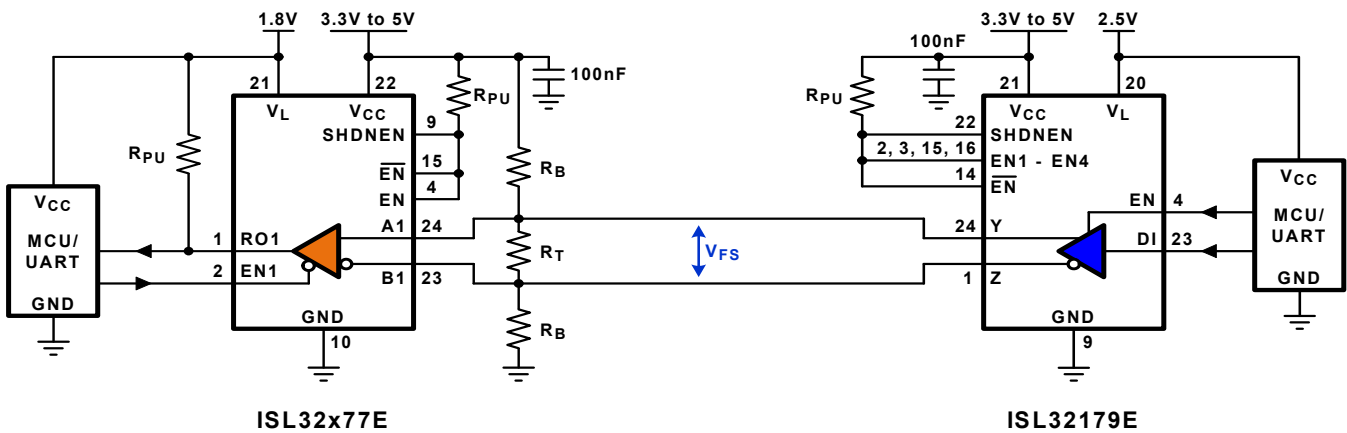

FIGURE 2. NETWORK USING PAIRED ENABLES



Using individual channel enable pins and configured for lowest shutdown supply current

*Note: When using separate supplies, Vcc must be powered up before VL*

Using active group enable pins and configured for lowest shutdown supply current

*Note: When using separate supplies, Vcc must be powered up before VL*

FIGURE 3. NETWORK WITH VL PIN FOR INTERFACING TO LOWER VOLTAGE LOGIC DEVICES

Note: To calculate the resistor values, see [TB509](#).

## Ordering Information

PART NUMBER (Notes 2, 3)	PART MARKING	TEMP. RANGE (°C)	TAPE AND REEL (UNITS) (Note 1)	PACKAGE (RoHS Compliant)	PKG. DWG. #
ISL32172EFBZ	ISL32172 EFBZ	-40 to +125	-	16 Ld SOIC	M16.15
ISL32172EFBZ-T	ISL32172 EFBZ	-40 to +125	2.5k	16 Ld SOIC	M16.15
ISL32172EFVZ	32172 EFVZ	-40 to +125	-	16 Ld TSSOP	MDP0044
ISL32172EFVZ-T	32172 EFVZ	-40 to +125	2.5k	16 Ld TSSOP	MDP0044
ISL32172EIBZ	ISL32172 EIBZ	-40 to +85	-	16 Ld SOIC	M16.15
ISL32172EIBZ-T	ISL32172 EIBZ	-40 to +85	2.5k	16 Ld SOIC	M16.15
ISL32172EIVZ	32172 EIVZ	-40 to +85	-	16 Ld TSSOP	MDP0044
ISL32172EIVZ-T	32172 EIVZ	-40 to +85	2.5k	16 Ld TSSOP	MDP0044
ISL32174EFVZ	32174 EFVZ	-40 to +125	-	16 Ld TSSOP	MDP0044
ISL32174EFVZ-T	32174 EFVZ	-40 to +125	2.5k	16 Ld TSSOP	MDP0044
ISL32174EIBZ	ISL32174 EIBZ	-40 to +85	-	16 Ld SOIC	M16.15
ISL32174EIBZ-T	ISL32174 EIBZ	-40 to +85	2.5k	16 Ld SOIC	M16.15
ISL32179EFRZ	321 79EFRZ	-40 to +125	-	24 Ld QFN	L24.4x4C
ISL32179EFRZ-T	321 79EFRZ	-40 to +125	6k	24 Ld QFN	L24.4x4C
ISL32179EIRZ	321 79EIRZ	-40 to +85	-	24 Ld QFN	L24.4x4C
ISL32179EIRZ-T	321 79EIRZ	-40 to +85	6k	24 Ld QFN	L24.4x4C
ISL32272EFBZ	ISL32272 EFBZ	-40 to +125	-	16 Ld SOIC	M16.15
ISL32272EFBZ-T	ISL32272 EFBZ	-40 to +125	2.5k	16 Ld SOIC	M16.15
ISL32272EFVZ	32272 EFVZ	-40 to +125	-	16 Ld TSSOP	MDP0044
ISL32272EFVZ-T	32272 EFVZ	-40 to +125	2.5k	16 Ld TSSOP	MDP0044

### NOTES:

1. See [TB347](#) for details about reel specifications.
2. These Pb-free plastic packaged products employ special Pb-free material sets, molding compounds/die attach materials, and 100% matte tin plate plus anneal (e3 termination finish, which is RoHS compliant and compatible with both SnPb and Pb-free soldering operations). Pb-free products are MSL classified at Pb-free peak reflow temperatures that meet or exceed the Pb-free requirements of IPC/JEDEC J STD-020.
3. For Moisture Sensitivity Level (MSL), see the [ISL32172E](#), [ISL32272E](#), [ISL32174E](#), and [ISL32179E](#) device pages. For more information about MSL, see [TB363](#).

## Truth Tables

ISL32172E and ISL32272E				
INPUTS			OUTPUTS	
EN	EN	DIX	ZX	YX
X	0	1/0	0/1	1/0
1	X	0/1	1/0	0/1
0	1	X	Z	Z

NOTE: Z = Tri-state

ISL32174E										
INPUTS			OUTPUTS							
EN12	EN34	DIX	Z1	Y1	Z2	Y2	Z3	Y3	Z4	Y4
0	0	X	Z	Z	Z	Z	Z	Z	Z	Z
0	1	1/0	Z	Z	Z	Z	0/1	1/0	0/1	1/0
1	0	1/0	0/1	1/0	0/1	1/0	Z	Z	Z	Z
1	1	1/0	0/1	1/0	0/1	1/0	0/1	1/0	0/1	1/0

NOTE: Z = Tri-state

ISL32179E								
INPUTS						OUTPUTS		
ENX	EN	EN	DIX	SPA	SPB	ZX	YX	COMMENTS
0	X	X	X	X	X	Z	Z	Ch X outputs disabled
X	0	1	X	X	X	Z	Z	All outputs disabled
1	X	0	1/0	1	1	0/1	1/0	Individual ENX controls Ch X (32Mbps)
1	1	X	0/1	1	1	1/0	0/1	
1	X	0	1/0	0	1	0/1	1/0	Individual ENX controls Ch X (10Mbps)
1	1	X	0/1	0	1	1/0	0/1	Individual ENX controls Ch X (460kbps)
1	X	0	1/0	X*	0	0/1	1/0	
1	1	X	0/1	X*	0	1/0	0/1	

NOTE: \*Keep SPA = 1 for lowest current in SHDN. If using individual channel enables and the SHDN mode, connect EN and  $\overline{\text{EN}}$  to  $V_{CC}$  for the lowest SHDN current. The ISL32179E enters SHDN when SHDNEN = 1 and all channels are disabled. Z = Tri-state.

## Pin Configurations

ISL32172E, ISL32272E  
(16 LD N-SOIC, TSSOP)  
TOP VIEWS

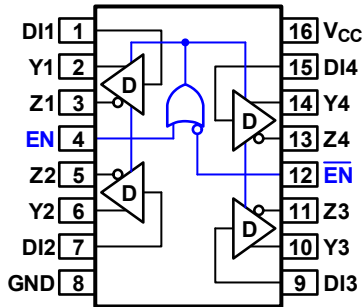

ISL32174E  
(16 LD N-SOIC, TSSOP)  
TOP VIEWS

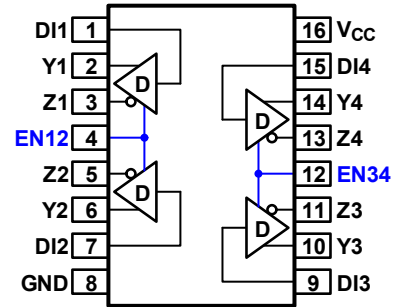

## Pin Configurations (Continued)

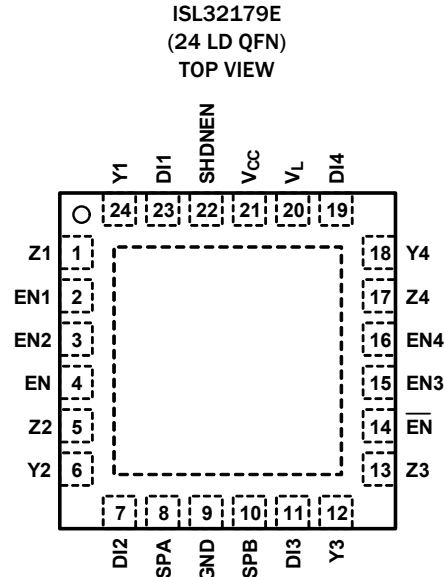

## Pin Descriptions

PIN	FUNCTION
EN, $\overline{\text{EN}}$	Group driver output enables that are internally pulled high to $V_{\text{CC}}$ . All ISL32x72E driver outputs, Y and Z, are enabled by driving EN high OR $\overline{\text{EN}}$ low. The outputs are high impedance when EN is low AND $\overline{\text{EN}}$ is high (for example, if using only the active high EN, connect $\overline{\text{EN}}$ directly to $V_{\text{CC}}$ or $V_{\text{L}}$ ; if using only the active low $\overline{\text{EN}}$ , connect EN directly to GND). To use group enable on the ISL32179E, connect all the ENX pins to $V_{\text{CC}}$ or $V_{\text{L}}$ and use the EN or $\overline{\text{EN}}$ pin as previously described. If the group driver enable function is not required (see <a href="#">Note 4</a> ), connect EN to $V_{\text{CC}}$ , or connect $\overline{\text{EN}}$ to GND (ISL32x72E and ISL32179E only).
EN12, EN34	Paired driver output enables that are internally pulled high to $V_{\text{CC}}$ . Driving EN12 (EN34) high enables the Channel 1 and 2 (3 and 4) outputs (Y and Z). Driving EN12 (EN34) low disables Channel 1 and 2 (3 and 4) outputs. If the driver enable function is not required (see <a href="#">Note 4</a> ), connect EN12 and EN34 to $V_{\text{CC}}$ (ISL32174E only).
ENx	Individual driver output enables that are internally pulled high to $V_{\text{CC}}$ . Forcing ENx high with EN high OR $\overline{\text{EN}}$ low enables the channel X outputs (Y and Z). Driving ENX low disables the Channel X outputs regardless of the states of EN and $\overline{\text{EN}}$ . Connect both EN and $\overline{\text{EN}}$ to $V_{\text{CC}}$ for the lowest SHDN current if using SHDN mode (see SHDNEN below). If the individual driver enable function is not required (see <a href="#">Note 4</a> ), connect ENX to $V_{\text{CC}}$ (ISL32179E only).
SHDNEN	Low power SHDN mode enable. A high level allows the ISL32179E to enter a low power mode when all channels are disabled. A low level prevents the device from entering the low power mode (ISL32179E only).
DIx	Driver input. A low on DI forces the corresponding channel's output Y low and output Z high. A high on DI forces output Y high and output Z low.
SPA, SPB	Speed select inputs that are internally pulled high. See the ISL32179E truth table on <a href="#">page 4</a> (ISL32179E only).
GND	Ground connection. This is also the potential of the QFN thermal pad.
Yx	$\pm 16.5\text{kV}$ IEC61000-4-2 ESD protected RS-422 level and a noninverting transmitter output.
Zx	$\pm 16.5\text{kV}$ IEC61000-4-2 ESD protected RS-422 level and an inverting transmitter output.
$V_{\text{CC}}$	System power supply input (3.0V to 5.5V). Power up $V_{\text{CC}}$ first on devices with a $V_{\text{L}}$ pin powered from a separate supply.
$V_{\text{L}}$	Logic power supply input. Connecting the $V_{\text{L}}$ pin to the lower voltage power supply of a logic device (such as a UART or microcontroller) interfacing with the ISL32179E configures its logic pin (DI, EN (all varieties), SHDNEN, and SP) $V_{\text{IL}}/V_{\text{IH}}$ levels to values compatible with the lower supply voltage. If $V_{\text{L}}$ and $V_{\text{CC}}$ are different supplies, power up this supply after $V_{\text{CC}}$ and keep $V_{\text{L}} \leq V_{\text{CC}}$ . (ISL32179E only)
EP	Thermal pad. Connect EP to GND (ISL32179E only).

NOTE:

- Tie unused EN pins with a 1k resistor to  $V_{\text{CC}}$ .

## Absolute Maximum Ratings

V <sub>CC</sub> to GND	7V
V <sub>L</sub> to GND (ISL32179E Only)	-0.3V to (V <sub>CC</sub> +0.3V)
Input Voltages	
DI, EN (all varieties)	-0.3V to 7V
Output Voltages	
Y, Z	-0.5V to 7V
Output Current	
Y, Z (per output, continuous, T <sub>J</sub> ≤ 125°C)	100mA
ESD Rating	See Electrical Specifications Table on <a href="#">page 7</a>

## Thermal Information

Thermal Resistance (Typical)	θ <sub>JA</sub> (°C/W)	θ <sub>JC</sub> (°C/W)
16 Ld SOIC Package ( <a href="#">Note 5</a> )	80	N/A
16 Ld TSSOP Package ( <a href="#">Note 5</a> )	105	N/A
24 Ld QFN Package ( <a href="#">Notes 6, 7</a> )	42	5
Maximum Junction Temperature (Plastic Package)	+150°C	
Maximum Storage Temperature Range	-65°C to +150°C	
Pb-free Reflow Profile	see <a href="#">TB493</a>	

## Operating Conditions

Temperature Range	
ISL32x7xEF	-40°C to +125°C
ISL32x7xEI	-40°C to +85°C

CAUTION: Do not operate at or near the maximum ratings listed for extended periods of time. Exposure to such conditions can adversely impact product reliability and result in failures not covered by warranty.

### NOTE:

- θ<sub>JA</sub> is measured with the component mounted on a high-effective thermal conductivity test board in free air. See [TB379](#) for details.
- θ<sub>JA</sub> is measured in free air with the component mounted on a high-effective thermal conductivity test board with "direct attach" features. See [TB379](#) for details.
- For θ<sub>JC</sub>, the "case temp" location is the center of the exposed metal pad on the package underside.

**Electrical Specifications** Test Conditions: V<sub>CC</sub> = 3.0V to 3.6V and 4.5V to 5.5V; V<sub>L</sub> = V<sub>CC</sub> (ISL32179E only); Typical values are at V<sub>CC</sub> = 3.3V or V<sub>CC</sub> = 5V, T<sub>A</sub> = +25°C unless otherwise specified ([Notes 8, 12](#)).

PARAMETER	SYMBOL	TEST CONDITIONS	TEMP (°C)	MIN ( <a href="#">Note 11</a> )	TYP	MAX ( <a href="#">Note 11</a> )	UNIT	
<b>DC CHARACTERISTICS</b>								
Differential V <sub>OUT</sub>	V <sub>OD</sub>	No load	Full	2.5	-	V <sub>CC</sub>	V	
		R <sub>L</sub> = 100Ω (RS-422) (see <a href="#">Figure 4</a> )	V <sub>CC</sub> ≥ 3V	Full	2	2.6	-	V
			V <sub>CC</sub> ≥ 4.5V	Full	3	4	-	V
Single-Ended V <sub>OUT</sub> (Y or Z)	V <sub>O</sub>	I <sub>O</sub> = -20mA, V <sub>OH</sub>	Full	2.4	2.7	-	V	
		I <sub>O</sub> = 20mA, V <sub>OL</sub>	Full	-	0.2	0.4	V	
Change in Magnitude of Driver Differential V <sub>OUT</sub> for Complementary Output States	ΔV <sub>OD</sub>	R <sub>L</sub> = 100Ω (see <a href="#">Figure 4</a> )	Full	-	0.01	0.2	V	
Driver Common-Mode V <sub>OUT</sub>	V <sub>OC</sub>	R <sub>L</sub> = 100Ω (see <a href="#">Figure 4</a> )	Full	-	2.6	3	V	
Change in Magnitude of Driver Common-Mode V <sub>OUT</sub> for Complementary Output States	ΔV <sub>OC</sub>	R <sub>L</sub> = 100Ω (see <a href="#">Figure 4</a> )	Full	-	0.01	0.2	V	
Input High Voltage (Logic Pins, <a href="#">Note 16</a> )	V <sub>IH1</sub>	All Transmitters and ISL32179E, if V <sub>L</sub> = V <sub>CC</sub>	3.0V ≤ V <sub>CC</sub> ≤ 3.6V, DI and ENs	Full	2.2	-	-	V
	V <sub>IH2</sub>		4.5V ≤ V <sub>CC</sub> ≤ 5.5V, DI	Full	2.7	-	-	V
	V <sub>IH2E</sub>		4.5V ≤ V <sub>CC</sub> ≤ 5.5V, ENs	Full	2.4	-	-	V
	V <sub>IH3</sub>	ISL32179E only	2.7V ≤ V <sub>L</sub> < 3.0V	Full	2.0	-	-	V
	V <sub>IH4</sub>		2.3V ≤ V <sub>L</sub> < 2.7V	Full	1.6	-	-	V
	V <sub>IH5</sub>		1.6V ≤ V <sub>L</sub> < 2.3V	Full	0.72*V <sub>L</sub>	-	-	V
	V <sub>IH6</sub>		1.5V ≤ V <sub>L</sub> < 1.6V	+25	-	0.45*V <sub>L</sub>	-	V
Input Low Voltage (Logic Pins, <a href="#">Note 16</a> )	V <sub>IL1</sub>	All Transmitters and ISL32179E, if V <sub>L</sub> = V <sub>CC</sub>		Full	-	-	0.8	V
	V <sub>IL2</sub>			Full	-	-	0.6	V
	V <sub>IL3</sub>	ISL32179E only	V <sub>L</sub> ≥ 2.7V	Full	-	-	0.6	V
	V <sub>IL4</sub>		2.3V ≤ V <sub>L</sub> < 2.7V	Full	-	-	0.6	V
	V <sub>IL5</sub>		1.6V ≤ V <sub>L</sub> < 2.3V	Full	-	-	0.22*V <sub>L</sub>	V
		1.5V ≤ V <sub>L</sub> < 1.6V	+25	-	0.25*V <sub>L</sub>	-	V	

**Electrical Specifications** Test Conditions:  $V_{CC} = 3.0V$  to  $3.6V$  and  $4.5V$  to  $5.5V$ ;  $V_L = V_{CC}$  (ISL32179E only); Typical values are at  $V_{CC} = 3.3V$  or  $V_{CC} = 5V$ ,  $T_A = +25^\circ C$  unless otherwise specified (Notes 8, 12). (Continued)

PARAMETER	SYMBOL	TEST CONDITIONS	TEMP (°C)	MIN (Note 11)	TYP	MAX (Note 11)	UNIT	
Logic Input Current	$I_{IN1}$	$DIX = 0V$ or $V_{CC}$	Full	-1	-	1	$\mu A$	
	$I_{IN2}$	$SP, EN, \overline{EN}, ENX, SHDNEN = 0V$ or $V_{CC}$	Full	-15	9	15	$\mu A$	
	$I_{IN3}$	$EN12, EN34 = 0V$ or $V_{CC}$	Full	-30	18	30	$\mu A$	
Output Leakage Current (Y, Z)	$I_{OZ}$	$EN = 0, V_{CC} = 0V$ to $5.5V, -0.25 \leq V_O \leq 6V$	Full	-10	-	10	$\mu A$	
		$EN = 0, V_{CC} = 3V$ to $5.5V, V_O = 0V$ to $V_{CC}$	+25	-8	-	8	nA	
		(Note 18)	-30	-	30	nA		
Driver Short-Circuit Current, $V_O =$ High or Low	$I_{OSD1}$	$EN = 1, V_Y$ or $V_Z = 0V$ (Note 9)	Full	-	-	$\pm 150$	mA	
		$EN = 1, V_Y$ or $V_Z = V_{CC}$ (Note 9)	Full	-	-	$\pm 200$	mA	
Thermal Shutdown Threshold	$T_{SD}$		Full	-	160	-	$^\circ C$	
<b>SUPPLY CURRENT</b>								
No-Load Supply Current	$I_{CC}$	$DI = 0V$ or $V_{CC}, EN = 1$	Full	-	0.6	0.8	mA	
Shutdown Supply Current	$I_{SHDN}$	$DI = 0V$ or $V_{CC}$ , all outputs disabled (Note 17), $SHDNEN = 1$ (ISL32179E only)	Full	-	60	90	$\mu A$	
<b>ESD PERFORMANCE</b>								
RS-422 Pins (Y, Z)		IEC61000-4-2, from bus pins to GND	Air gap	+25	-	$\pm 16.5$	-	kV
			Contact	+25	-	$\pm 9$	-	kV
		Human Body Model, from bus pins to GND		+25	-	$\pm 15$	-	kV
All Pins		HBM, per MIL-STD-883 Method 3015		+25	-	$\pm 12$	-	kV
		Machine Model		+25	-	700	-	V
<b>DRIVER SWITCHING CHARACTERISTICS (ISL32179E, 460kbps)</b>								
Maximum Data Rate	$f_{MAX}$	$V_{OD} = \pm 1.5V, C_D = 820pF$ (see Figure 7)	Full	460	4000	-	kbps	
Driver Single-Ended Output Delay	$t_{PLH}, t_{PHL}$	$R_{DIFF} = 100\Omega, C_D = 50pF$ (see Figure 5)	Full	-	90	300	ns	
Driver Single-Ended Output Skew	$t_{SSK}$	$R_{DIFF} = 100\Omega, C_D = 50pF$ (see Figure 5)	Full	-	55	150	ns	
Channel-to-Channel Output Delay Skew	$t_{SKCC}$	(Figure 5, Note 13)	Full	-	60	200	ns	
Part-to-Part Output Delay Skew	$t_{SKPP}$	(Figure 5, Note 10)	Full	-	-	300	ns	
Driver Differential Output Skew	$t_{DSK}$	$R_{DIFF} = 100\Omega, C_D = 50pF$ (see Figure 5)	Full	-	2	60	ns	
Driver Differential Rise or Fall Time	$t_R, t_F$	$R_{DIFF} = 100\Omega, C_D = 50pF$ (see Figure 5)	Full	60	100	220	ns	
Driver Enable to Output High	$t_{ZH}$	$SW = GND$ (see Figure 6, Note 14)	Full	-	-	200	ns	
Driver Enable to Output Low	$t_{ZL}$	$SW = V_{CC}$ (see Figure 6, Note 14)	Full	-	-	200	ns	
Driver Disable from Output High	$t_{HZ}$	$SW = GND$ (see Figure 6)	Full	-	-	100	ns	
Driver Disable from Output Low	$t_{LZ}$	$SW = V_{CC}$ (see Figure 6)	Full	-	-	100	ns	
Driver Enable from SHDN to High	$t_{SDH}$	ISL32179E only, $SW = GND$ (see Figure 6, Note 15)	Full	-	-	750	ns	
Driver Enable from SHDN to Low	$t_{SDL}$	ISL32179E only, $SW = V_{CC}$ (see Figure 6, Note 15)	Full	-	-	750	ns	
<b>DRIVER SWITCHING CHARACTERISTICS (ISL32272E, ISL32179E, 10Mbps)</b>								
Maximum Data Rate	$f_{MAX}$	$V_{OD} = \pm 1.5V, C_D = 400pF$ (see Figure 7)	Full	10	20	-	Mbps	
Driver Single-Ended Output Delay	$t_{PLH}, t_{PHL}$	$R_{DIFF} = 100\Omega, C_D = 50pF$ (see Figure 5)	Full	-	13	25	ns	
Driver Single-Ended Output Skew	$t_{SSK}$	$R_{DIFF} = 100\Omega, C_D = 50pF$ (see Figure 5)	Full	-	2	9	ns	
Channel-to-Channel Output Delay Skew	$t_{SKCC}$	(Figure 5, Note 13)	Full	-	6	12	ns	
Part-to-Part Output Delay Skew	$t_{SKPP}$	(Figure 5, Note 10)	Full	-	-	20	ns	
Driver Differential Output Skew	$t_{DSK}$	$R_{DIFF} = 100\Omega, C_D = 50pF$ (see Figure 5)	Full	-	2	6	ns	
Driver Differential Rise or Fall Time	$t_R, t_F$	$R_{DIFF} = 100\Omega, C_D = 50pF$ (see Figure 5)	Full	7	11	20	ns	
Driver Enable to Output High	$t_{ZH}$	$SW = GND$ (see Figure 6, Note 14)	Full	-	-	20	ns	
Driver Enable to Output Low	$t_{ZL}$	$SW = V_{CC}$ (see Figure 6, Note 14)	Full	-	-	20	ns	

**Electrical Specifications** Test Conditions:  $V_{CC} = 3.0V$  to  $3.6V$  and  $4.5V$  to  $5.5V$ ;  $V_L = V_{CC}$  (ISL32179E only); Typical values are at  $V_{CC} = 3.3V$  or  $V_{CC} = 5V$ ,  $T_A = +25^\circ C$  unless otherwise specified (Notes 8, 12). (Continued)

PARAMETER	SYMBOL	TEST CONDITIONS	TEMP (°C)	MIN (Note 11)	TYP	MAX (Note 11)	UNIT
Driver Disable from Output High	$t_{HZ}$	SW = GND (see Figure 6)	Full	-	-	20	ns
Driver Disable from Output Low	$t_{LZ}$	SW = $V_{CC}$ (see Figure 6)	Full	-	-	20	ns
Driver Enable from SHDN to High	$t_{SDH}$	ISL32179E only, SW = GND (see Figure 6, Note 15)	Full	-	-	750	ns
Driver Enable from SHDN to Low	$t_{SDL}$	ISL32179E only, SW = $V_{CC}$ (see Figure 6, Note 15)	Full	-	-	750	ns
<b>DRIVER SWITCHING CHARACTERISTICS (ISL32172E, ISL32174E, ISL32179E, 32Mbps)</b>							
Maximum Data Rate	$f_{MAX}$	$V_{OD} = \pm 1.5V$ , $C_D = 100pF$ (see Figure 7)	Full	32	50	-	Mbps
Driver Single-Ended Output Delay	$t_{PLH}$ , $t_{PHL}$	$R_{DIFF} = 100\Omega$ , $C_D = 50pF$ (see Figure 5)	Full	3	8	15	ns
Driver Single-Ended Output Skew	$t_{SSK}$	$R_{DIFF} = 100\Omega$ , $C_D = 50pF$ (see Figure 5)	Full	-	1	3.5	ns
Channel-to-Channel Output Delay Skew	$t_{SKCC}$	(Figure 5, Note 13)	Full	-	3	5.5	ns
Part-to-Part Output Delay Skew	$t_{SKPP}$	(Figure 5, Note 10)	Full	-	-	8	ns
Driver Differential Output Skew	$t_{DSK}$	$R_{DIFF} = 100\Omega$ , $C_D = 50pF$ (see Figure 5)	Full	-	0.5	2	ns
Driver Differential Rise or Fall Time	$t_R$ , $t_F$	$R_{DIFF} = 100\Omega$ , $C_D = 50pF$ (see Figure 5)	Full	-	7	12	ns
Driver Enable to Output High	$t_{ZH}$	SW = GND (see Figure 6, Note 14)	Full	-	-	20	ns
Driver Enable to Output Low	$t_{ZL}$	SW = $V_{CC}$ (see Figure 6, Note 14)	Full	-	-	20	ns
Driver Disable from Output High	$t_{HZ}$	SW = GND (see Figure 6)	Full	-	-	20	ns
Driver Disable from Output Low	$t_{LZ}$	SW = $V_{CC}$ (see Figure 6)	Full	-	-	20	ns
Driver Enable from SHDN to High	$t_{SDH}$	ISL32179E only, SW = GND (see Figure 6, Note 15)	Full	-	-	750	ns
Driver Enable from SHDN to Low	$t_{SDL}$	ISL32179E only, SW = $V_{CC}$ (see Figure 6, Note 15)	Full	-	-	750	ns

## NOTES:

- All currents into device pins are positive; all currents out of device pins are negative. All voltages are referenced to device ground unless otherwise specified.
- Applies to peak current. See "Typical Performance Curves" beginning on page 10 for more information.
- $t_{SKPP}$  is the magnitude of the difference in propagation delays of the specified terminals of two units tested with identical test conditions ( $V_{CC}$ , temperature, etc.).
- Parameters with MIN and/or MAX limits are 100% tested at  $+25^\circ C$ , unless otherwise specified. Temperature limits established by characterization and are not production tested.
- EN = 0 indicates that the output(s) under test are disabled via the appropriate logic pin settings. EN = 1 indicates that the logic pins are set to enable the output(s) under test.
- Channel-to-channel skew is the magnitude of the worst case delta between any two propagation delays of any two outputs on the same IC at the same test conditions.
- Keep SHDNEN low to avoid entering shutdown (ISL32179E only).
- Keep SHDNEN high to enter shutdown when all transmitters are disabled (ISL32179E only).
- Logic pins are the DIs, the enable variants, and SHDNEN.
- Only one of the SPX pins low, plus EN1-EN4 low with EN and  $\overline{EN}$  high, or EN low and  $\overline{EN}$  high with EN1-EN4 high.
- Temperature range is  $-20^\circ C$  to  $+40^\circ C$ .



## Test Circuits and Waveforms

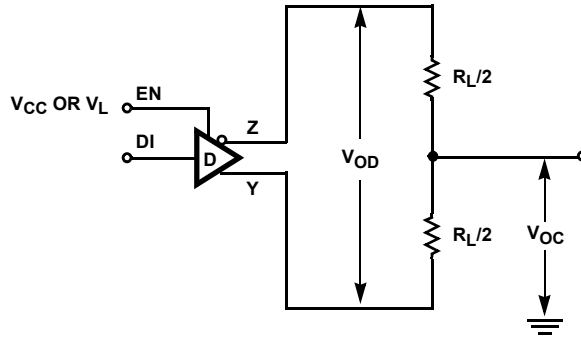

FIGURE 4. DC DRIVER TEST CIRCUITS

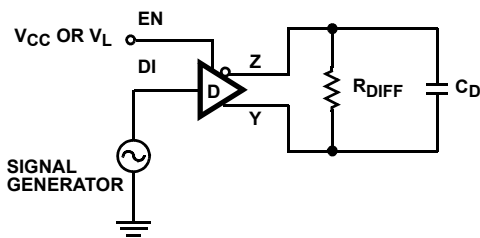

FIGURE 5A. TEST CIRCUIT

FIGURE 5. DRIVER PROPAGATION DELAY AND DIFFERENTIAL TRANSITION TIMES

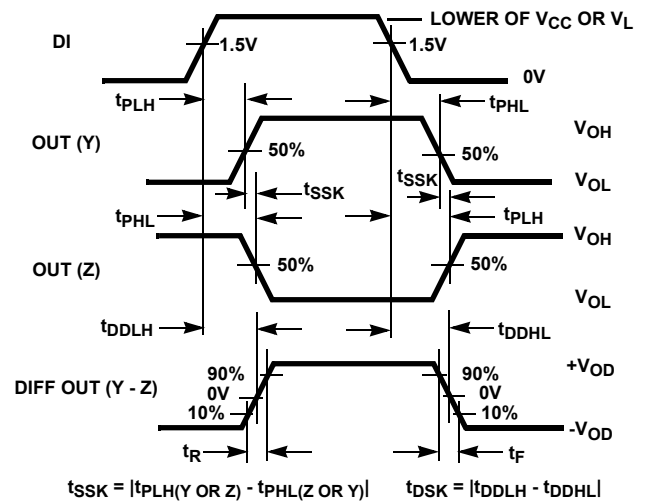
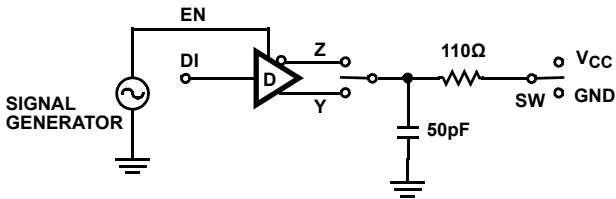

FIGURE 5B. MEASUREMENT POINTS



PARAMETER	OUTPUT	DI	SW
$t_{HZ}$	Y/Z	1/0	GND
$t_{LZ}$	Y/Z	0/1	$V_{CC}$
$t_{ZH}$ (Note 14)	Y/Z	1/0	GND
$t_{ZL}$ (Note 14)	Y/Z	0/1	$V_{CC}$
$t_{SDH}$ (Note 15)	Y/Z	1/0	GND
$t_{SDL}$ (Note 15)	Y/Z	0/1	$V_{CC}$

FIGURE 6A. TEST CIRCUIT

FIGURE 6. DRIVER ENABLE AND DISABLE TIMES

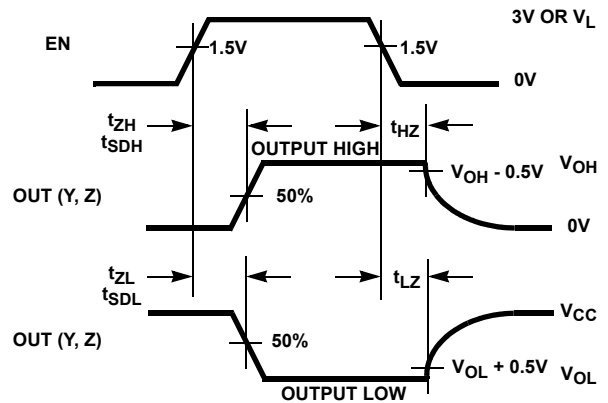

FIGURE 6B. MEASUREMENT POINTS

## Test Circuits and Waveforms (Continued)

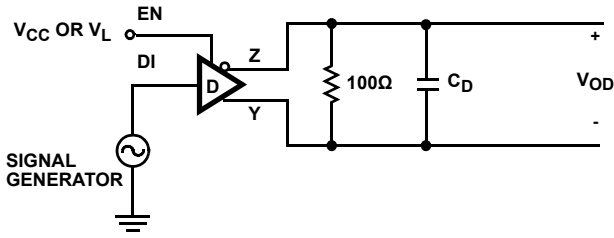

FIGURE 7A. TEST CIRCUIT

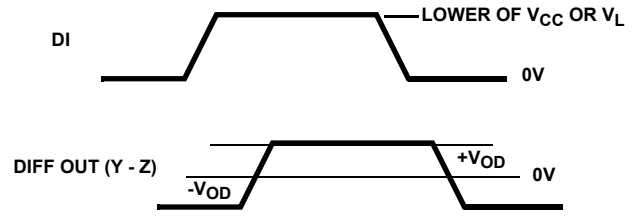

FIGURE 7B. MEASUREMENT POINTS

FIGURE 7. DRIVER DATA RATE

## Typical Performance Curves

$V_{CC} = V_L = 3.3V$  or  $5V$ ,  $T_A = +25^\circ C$ , unless otherwise specified.  $V_L$  notes apply to the ISL32179E only.

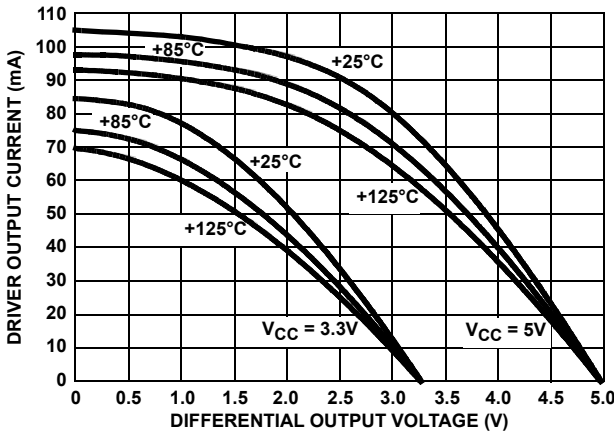

FIGURE 8. DRIVER OUTPUT CURRENT vs DIFFERENTIAL OUTPUT VOLTAGE

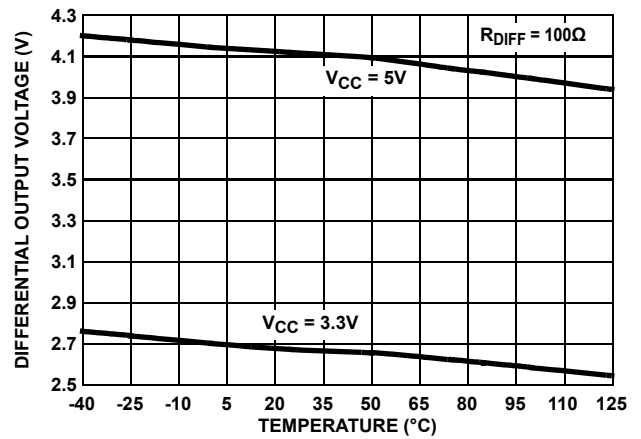

FIGURE 9. DRIVER DIFFERENTIAL OUTPUT VOLTAGE vs TEMPERATURE

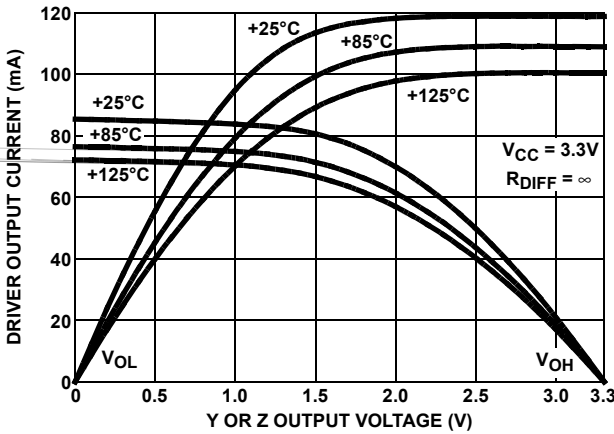

FIGURE 10. DRIVER SINGLE-ENDED (Y OR Z) OUTPUT CURRENT vs OUTPUT VOLTAGE

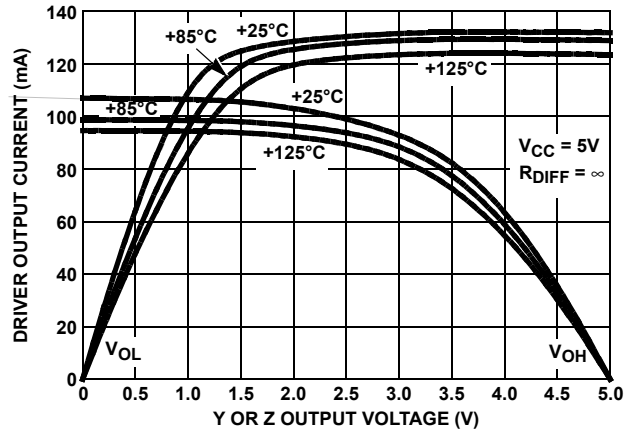

FIGURE 11. DRIVER SINGLE-ENDED (Y OR Z) OUTPUT CURRENT vs OUTPUT VOLTAGE

## Typical Performance Curves

$V_{CC} = V_L = 3.3V$  or  $5V$ ,  $T_A = +25^\circ C$ , unless otherwise specified.  $V_L$  notes apply to the ISL32179E only. (Continued)

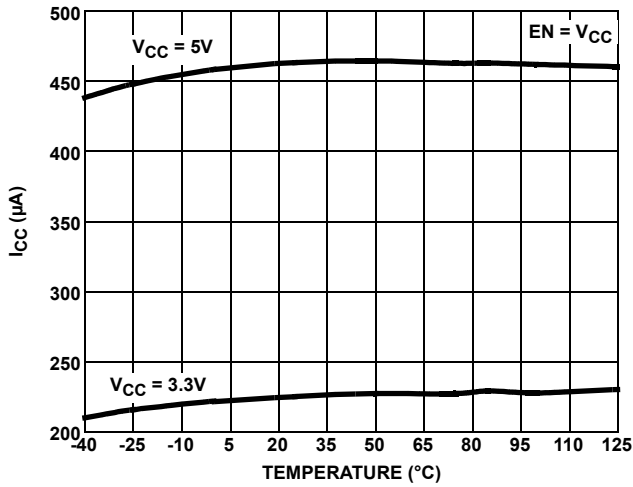

FIGURE 12. SUPPLY CURRENT vs TEMPERATURE

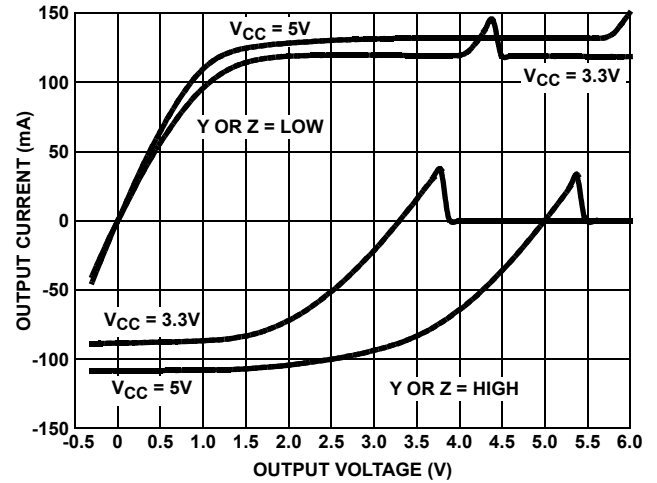

FIGURE 13. DRIVER OUTPUT CURRENT vs SHORT-CIRCUIT VOLTAGE

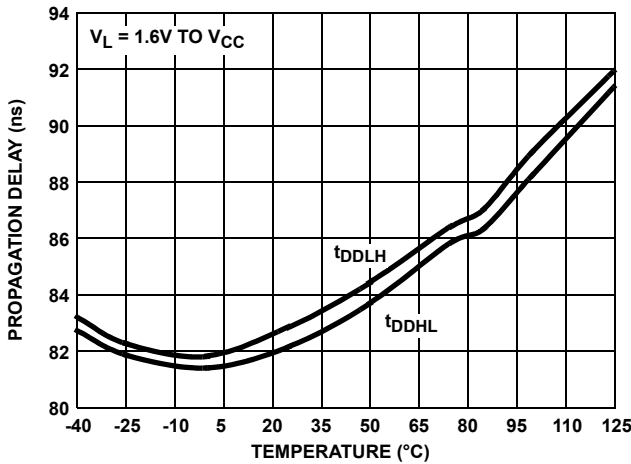

FIGURE 14. DRIVER DIFFERENTIAL PROPAGATION DELAY vs TEMPERATURE (ISL32179E, 460kbps OPTION)

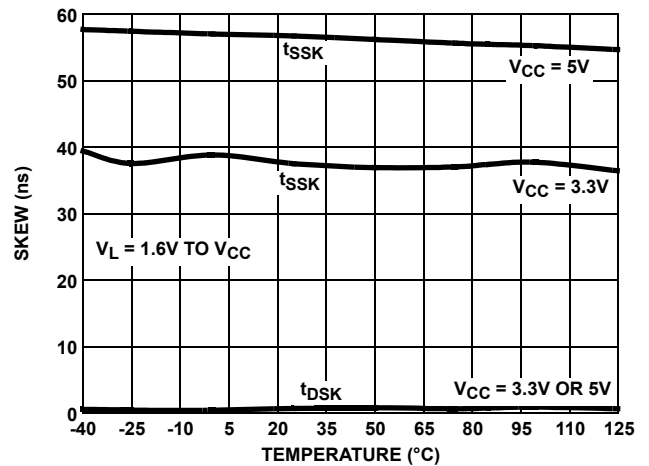

FIGURE 15. DRIVER SKEW vs TEMPERATURE (ISL32179E, 460kbps OPTION)

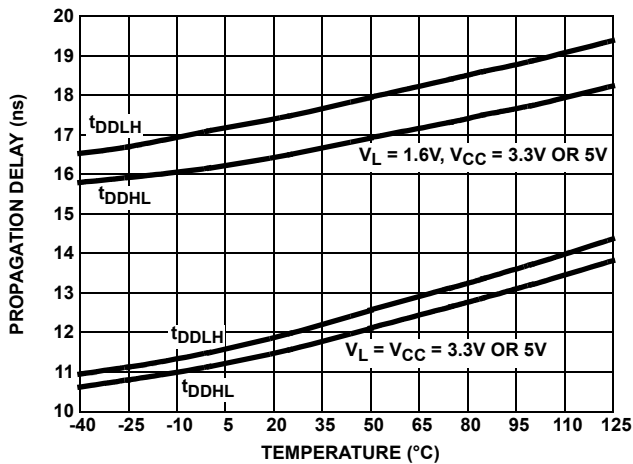

FIGURE 16. DRIVER DIFFERENTIAL PROPAGATION DELAY vs TEMPERATURE (ISL32272E, ISL32179E, 10Mbps OPTION)

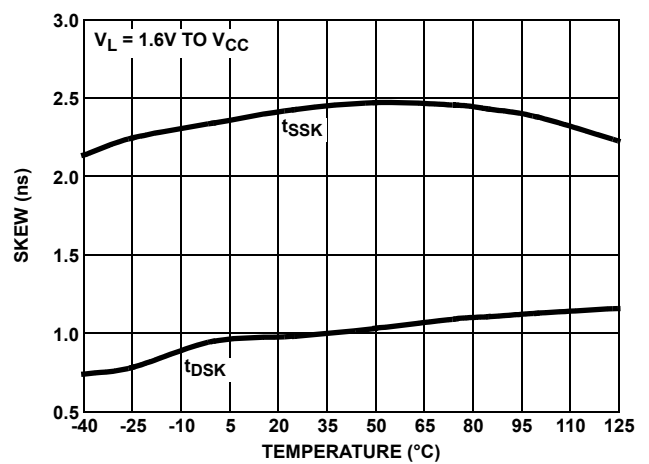

FIGURE 17. DRIVER SKEW vs TEMPERATURE (ISL32272E, ISL32179E, 10Mbps OPTION)

# Typical Performance Curves

$V_{CC} = V_L = 3.3V$  or  $5V$ ,  $T_A = +25^\circ C$ , unless otherwise specified.  $V_L$  notes apply to the ISL32179E only. (Continued)

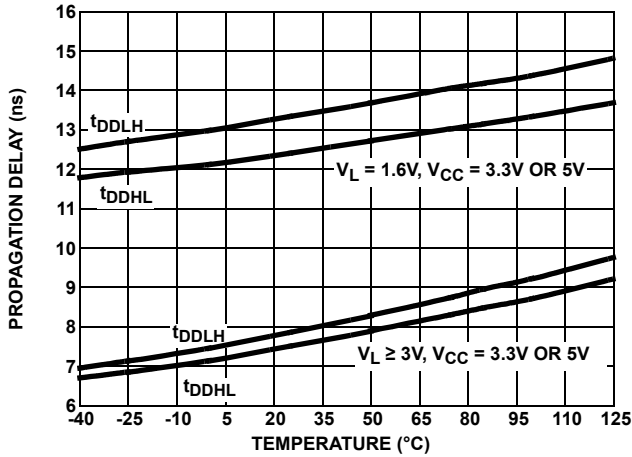

FIGURE 18. DRIVER DIFFERENTIAL PROPAGATION DELAY vs TEMPERATURE (ISL32172E, ISL32174E, ISL32179E, 32Mbps OPTION)

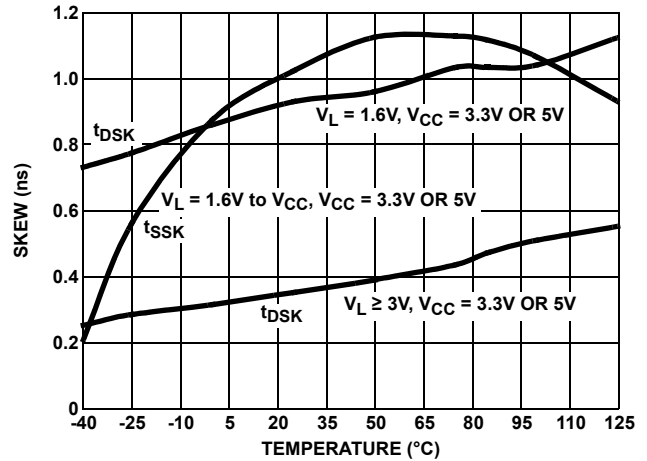

FIGURE 19. DRIVER SKEW vs TEMPERATURE (ISL32172E, ISL32174E, ISL32179E, 32Mbps OPTION)

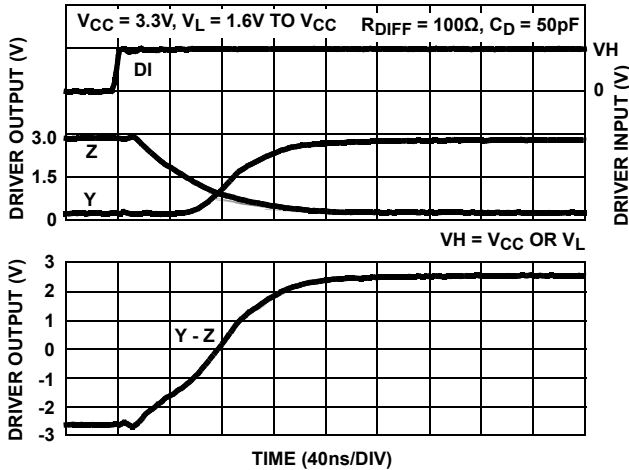

FIGURE 20. DRIVER WAVEFORMS, LOW TO HIGH (ISL32179E)

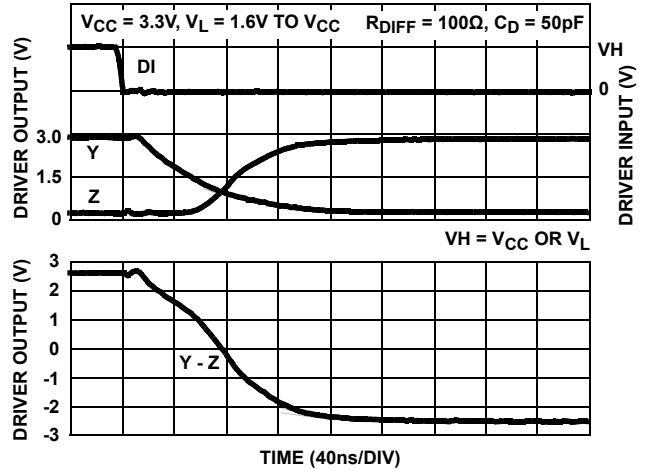

FIGURE 21. DRIVER WAVEFORMS, HIGH TO LOW (ISL32179E)

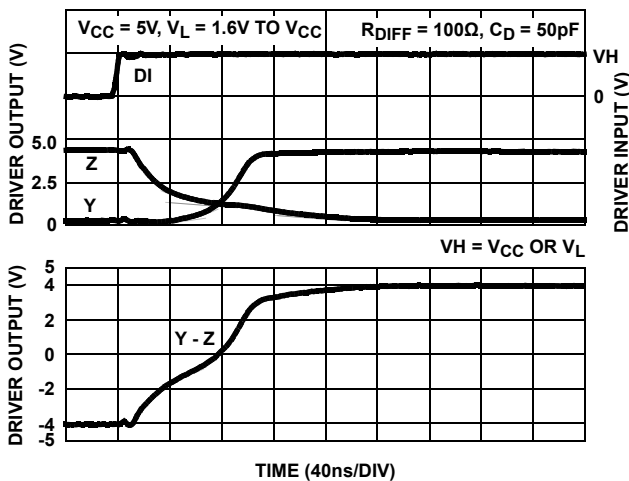

FIGURE 22. DRIVER WAVEFORMS, LOW TO HIGH (ISL32179E)

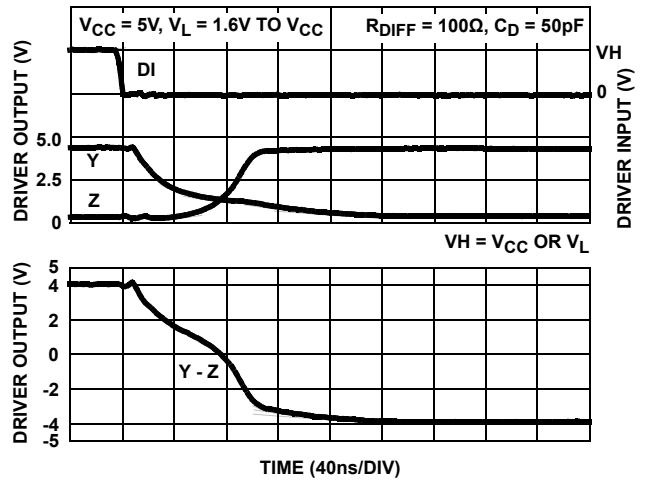

FIGURE 23. DRIVER WAVEFORMS, HIGH TO LOW (ISL32179E)

## Typical Performance Curves

$V_{CC} = V_L = 3.3V$  or  $5V$ ,  $T_A = +25^\circ C$ , unless otherwise specified.  $V_L$  notes apply to the ISL32179E only. (Continued)

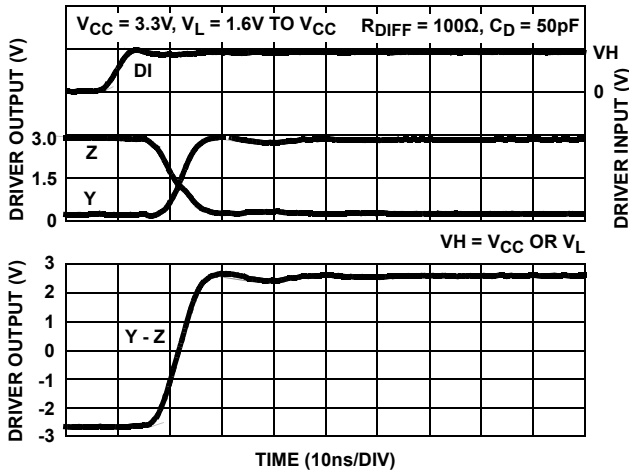

FIGURE 24. DRIVER WAVEFORMS, LOW TO HIGH (ISL32272E, ISL32179E)

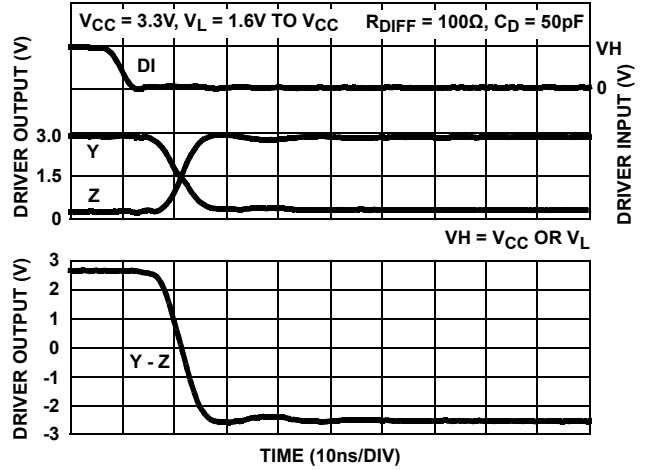

FIGURE 25. DRIVER WAVEFORMS, HIGH TO LOW (ISL32272E, ISL32179E)

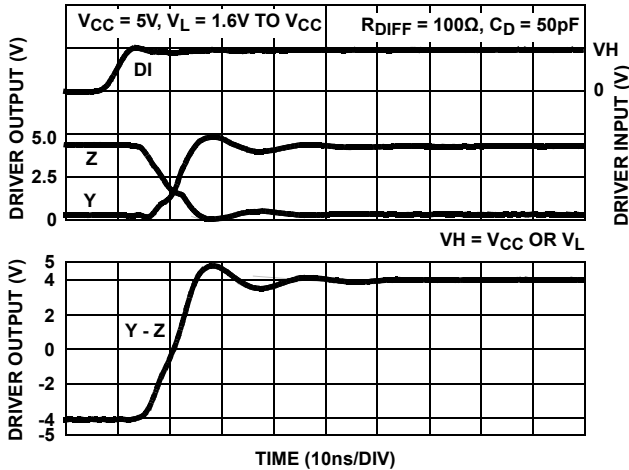

FIGURE 26. DRIVER WAVEFORMS, LOW TO HIGH (ISL32272E, ISL32179E)

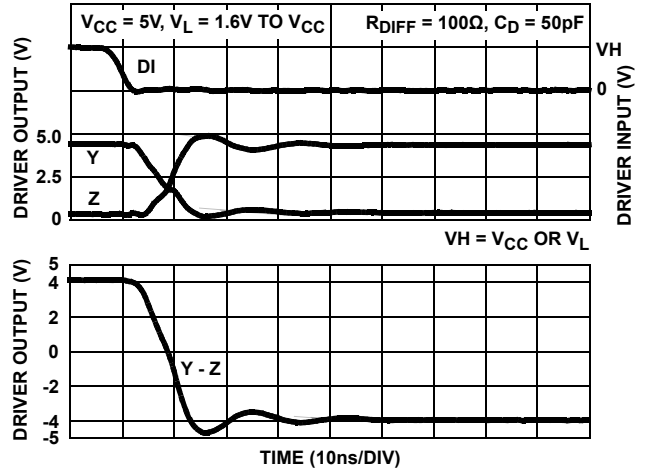

FIGURE 27. DRIVER WAVEFORMS, HIGH TO LOW (ISL32272E, ISL32179E)

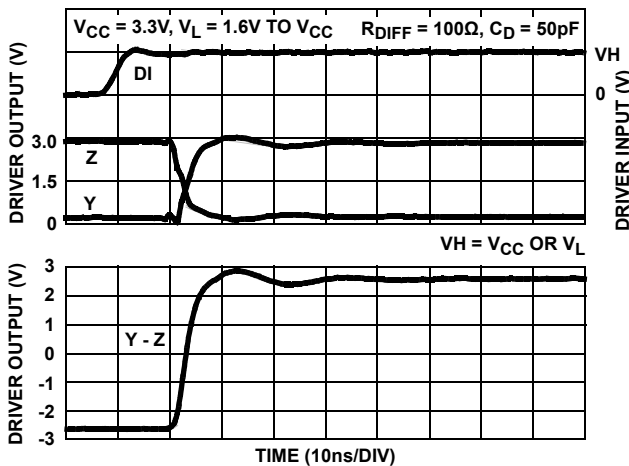

FIGURE 28. DRIVER WAVEFORMS, LOW TO HIGH (ISL32172E, ISL32174E, ISL32179E)

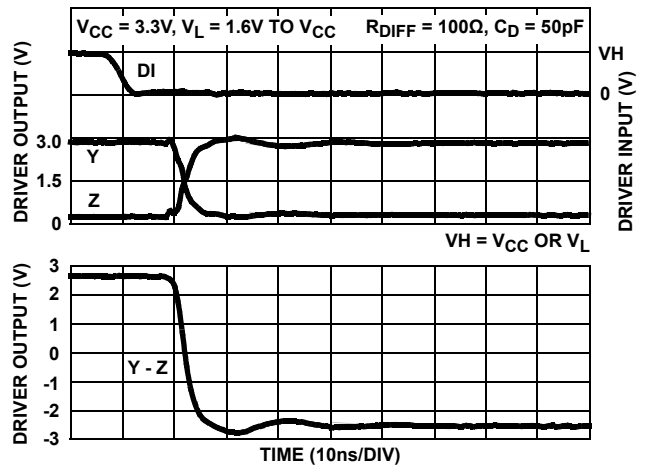

FIGURE 29. DRIVER WAVEFORMS, HIGH TO LOW (ISL32172E, ISL32174E, ISL32179E)

## Typical Performance Curves

$V_{CC} = V_L = 3.3V$  or  $5V$ ,  $T_A = +25^\circ C$ , unless otherwise specified.  $V_L$  notes apply to the ISL32179E only. (Continued)

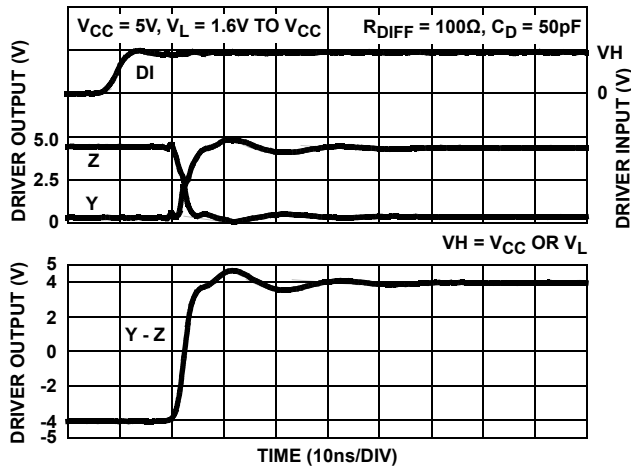

FIGURE 30. DRIVER WAVEFORMS, LOW TO HIGH (ISL32172E, ISL32174E, ISL32179E)

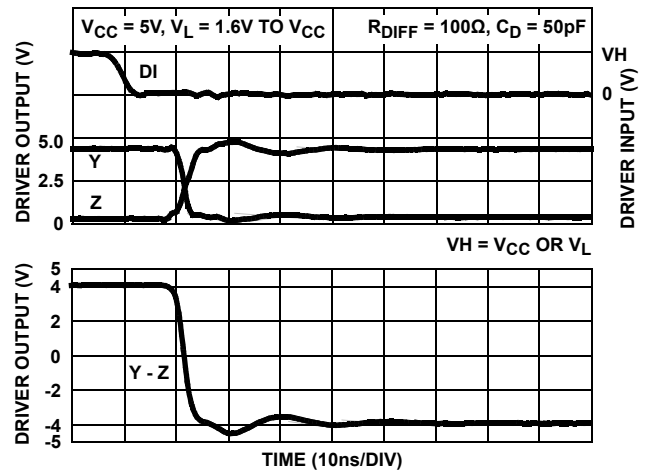

FIGURE 31. DRIVER WAVEFORMS, HIGH TO LOW (ISL32172E, ISL32174E, ISL32179E)

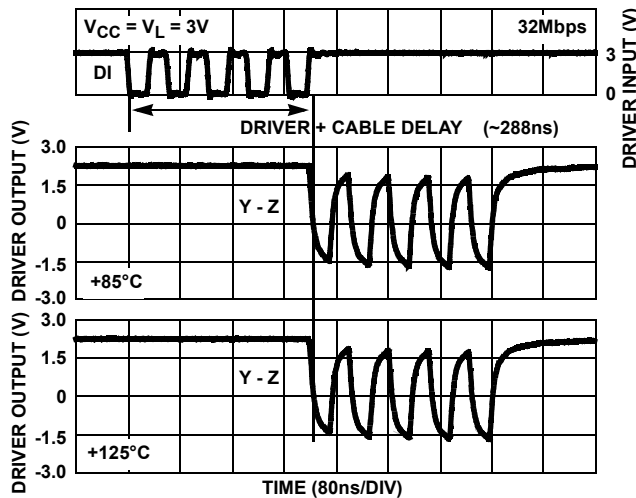

FIGURE 32. WORST CASE (NEGATIVE) FIVE PULSE DRIVER WAVEFORMS DRIVING 200 FEET (62m) OF CAT5 CABLE (SINGLE TERMINATED WITH  $121\Omega$ ) (ISL32172E, ISL32174E, ISL32179E)

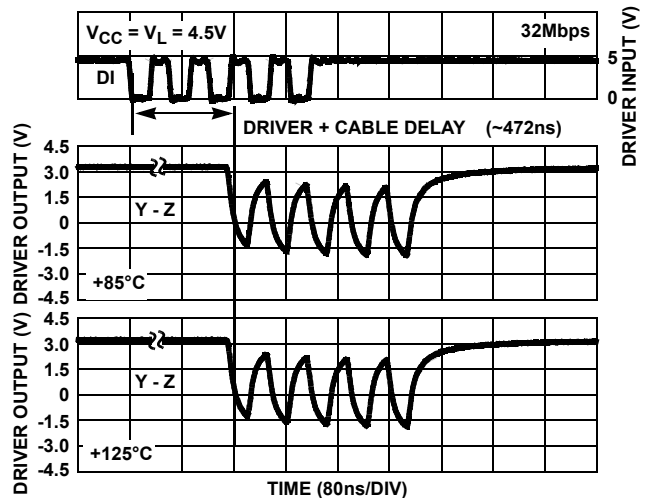

FIGURE 33. WORST CASE (NEGATIVE) FIVE PULSE DRIVER WAVEFORMS DRIVING 328 FEET (100m) OF CAT5 CABLE (SINGLE TERMINATED WITH  $121\Omega$ ) (ISL32172E, ISL32174E, ISL32179E)

## Application Information

RS-422 is a differential (balanced) data transmission standard for use in long haul or noisy environments. RS-422 is a point-to-multipoint (multidrop) standard, which allows only one driver and up to 10 receivers on each bus (assuming one unit load devices).

### Driver Features

The RS-422 drivers are differential output devices that deliver at least 2V across a  $100\Omega$  load. The drivers feature low propagation delay skew to maximize bit width and minimize EMI.

The 460kbps driver outputs are slew rate limited to minimize EMI and to reduce reflections in unterminated or improperly terminated networks. The 10Mbps and 32Mbps driver outputs

are not limited, so faster output transition times allow the higher data rates.

### Driver Enable Functions

All product types allow disabling of the Tx outputs. The ISL32x72E types feature group (all four Tx) enable functions that are active high (EN) or active low ( $\overline{EN}$ ). Drivers enable when  $EN = 1$  or when  $\overline{EN} = 0$ , and they disable only when  $EN = 0$  and  $\overline{EN} = 1$ . The ISL32174E uses active high paired enable functions (EN12 and EN34) that enable (when high) or disable (when low) the corresponding pairs of Tx. All four of these enable pins have internal pull-up resistors to  $V_{CC}$ , but unused enable pins that need to be high (for example,  $\overline{EN}$  when using the EN input for enable control, or EN12 and EN34 when using always enabled drivers) should always be connected externally to  $V_{CC}$ . If  $V_{CC}$  transients might exceed 7V, insert a series resistor between the

input(s) and  $V_{CC}$  to limit the current that flows if the input's ESD protection starts conducting.

The ISL32179E has the most flexible enable scheme. Its six enable pins allow for group, paired, or individual channel enable control. [Figure 34](#) details the ISL32179E's internal enable logic. To use a group enable function, connect all the ENx pins high and set all unused enable pins high. For paired enables, connect EN and  $\overline{EN}$  high (for the lowest current in shutdown mode, if SHDNEN is used), tie EN1 and EN2 together, and tie EN3 and EN4 together. For individual channel enables, connect EN and  $\overline{EN}$  high and drive the appropriate ENx (active high) for the particular channel. All of the enable pins incorporate pull-up resistors to  $V_{CC}$ , but unused enable pins of any type should be externally connected high rather than being left floating. Connecting to  $V_{CC}$  is the best choice, but  $V_L$  can be used as long as SHDN power is not a primary concern (for each  $V_L$  connected input,  $I_{CC}$  increases by  $(V_{CC} - V_L)/600k\Omega$ ). If  $V_{CC}$  or  $V_L$  transients might exceed 7V, insert a series resistor between the input(s) and the supply to limit the current that flows if the input's ESD protection starts conducting.

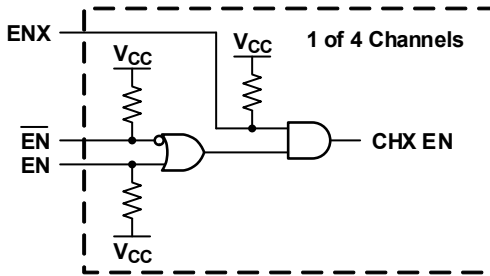

FIGURE 34. ISL32179E ENABLE LOGIC

### Wide Supply Range

The ISL 32x7xE devices are designed to operate with a wide range of supply voltages from 3.0V to 5.5V, and they meet the RS-422 specifications for that full supply voltage range.

### 5.5V TOLERANT LOGIC PINS

The logic input pins (driver inputs, enable pins, and SHDNEN) contain no ESD or parasitic diodes to  $V_{CC}$  to  $V_L$ , so they withstand input voltages exceeding 5.5V regardless of the  $V_{CC}$  and  $V_L$  voltages. Input voltages up to 7V are easily tolerated.

### Logic Supply ( $V_L$ Pin, ISL32179E Only)

**Note:** If powered from separate supplies, power up  $V_{CC}$  before powering up the  $V_L$  supply. If unused enable pins are connected to  $V_L$  rather than to  $V_{CC}$ , a small  $I_{CC}$   $((V_{CC} - V_L)/600k\Omega)$  flows due to the internal pull-up resistor connecting to  $V_{CC}$ .

The ISL32179E's  $V_L$  pin powers the logic inputs (driver inputs, enable pins, and SHDNEN). These pins interface with "logic" devices such as UARTs, ASICs, and microcontrollers, and most of these devices use power supplies significantly lower than 3.3V. Thus, the logic device's low  $V_{OH}$  might not exceed the  $V_{IH}$  of a 3.3V or 5V powered DI or enable input. Connecting the  $V_L$  pin to the power supply of the logic device (as shown in [Figure 35](#)) reduces the DI and enable input switching points to values compatible with the logic device's output levels. Configure the logic pin input switching points to the supply voltage of the UART,

ASIC, or microcontroller to eliminate the need for a level shifter/translator between the two ICs.

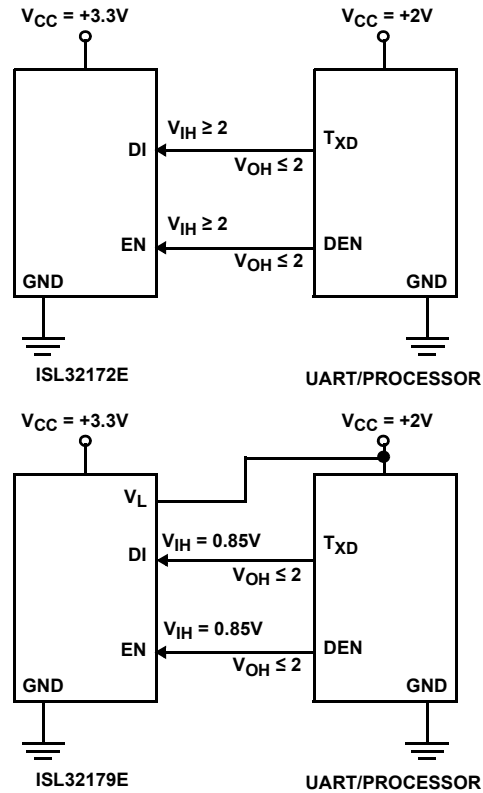

FIGURE 35. USING  $V_L$  PIN TO ADJUST LOGIC LEVELS

$V_L$  can be anywhere from  $V_{CC}$  down to 1.5V. [Table 2](#) indicates typical  $V_{IH}$  and  $V_{IL}$  values for various  $V_L$  settings so you can determine whether or not a particular  $V_L$  voltage meets your needs.

TABLE 2.  $V_{IH}$  AND  $V_{IL}$  vs  $V_L$  FOR  $V_{CC} = 3.3V$  OR  $5V$

$V_L$ (V)	$V_{IH}$ (V)	$V_{IL}$ (V)
1.6	0.7	0.45
2	0.85	0.6
2.3	1.1	0.75
2.7	1.4 (DI), 1.1 (ENs)	0.85
2.7	2	0.8
3.3	2.2	0.8

### Hot Plug Function

When a piece of equipment powers up, there is a period of time when the processor or ASIC driving the RS-422 control lines (EN,  $\overline{EN}$ , ENx) is unable to ensure that the RS-422 Tx outputs remain disabled. If the equipment is connected to the bus, a driver activating prematurely during power-up may drive invalid data on the bus. To avoid this scenario, the ISL32172E/32272E/32174E/32179E family incorporates a hot plug function. During power-up, circuitry monitoring  $V_{CC}$  ensures that the Tx outputs remain disabled for a period of time,

regardless of the state of the enable pins. The disabled Tx outputs give the processor/ASIC a chance to stabilize and drive the RS-422 control lines to the proper states.

## ESD Protection

All pins on the ISL32172E/32272E/32174E/32179E devices include Class 3 (>12kV) Human Body Model (HBM) ESD protection structures, but the RS-422 pins (driver outputs) incorporate advanced structures allowing them to survive ESD events in excess of  $\pm 15\text{kV}$  HBM, and  $\pm 16.5\text{kV}$  to IEC61000-4-2. The RS-422 pins are particularly vulnerable to ESD damage because they typically connect to an exposed port on the exterior of the finished product. Touching the port pins or connecting a cable can cause an ESD event that might destroy unprotected ICs. The new ESD structures protect the device whether or not it is powered up and without degrading the RS-422 common-mode range of  $-0.3\text{V}$  to  $+6\text{V}$ . The built-in ESD protection eliminates the need for board level protection structures such as transient suppression diodes and the associated undesirable capacitive load they present.

## IEC61000-4-2 Testing

The IEC61000 test method applies to finished equipment rather than to an individual IC. Therefore, the pins most likely to suffer an ESD event are those that are exposed to the outside world (the RS-422 pins in this case) and the IC is tested in its typical application configuration (power applied) rather than testing each pin-to-pin combination. The IEC61000 standard's lower current limiting resistor coupled with the larger charge storage capacitor yields a test that is much more severe than the HBM test. The extra ESD protection built into this device's RS-422 pins allows the design of equipment meeting level 4 criteria without the need for additional board level protection on the RS-422 port.

## AIR-GAP DISCHARGE TEST METHOD

For the air-gap discharge test method, a charged probe tip moves toward the IC pin until the voltage arcs to it. The current waveform delivered to the IC pin depends on approach speed, humidity, temperature, etc., so it is difficult to obtain repeatable results. The RS-422 pins withstand  $\pm 16.5\text{kV}$  air-gap discharges.

## CONTACT DISCHARGE TEST METHOD

During the contact discharge test, the probe contacts the tested pin before the probe tip is energized and eliminates the variables associated with the air-gap discharge. The result is a more repeatable and predictable test, but equipment limits prevent testing devices at voltages higher than  $\pm 9\text{kV}$ . The ISL32172E/32272E/32174E/32179E devices survive  $\pm 9\text{kV}$  contact discharges on the RS-422 pins.

## Data Rate, Cables, and Terminations

RS-422 is intended for network lengths up to 4000ft, but the maximum system data rate decreases as the transmission length increases. Devices operating at 32Mbps handle lengths up to 328ft (100m) in 5V systems, and lengths up to 200ft (62m)

in 3.3V systems (see [Figures 32](#) and [33](#)). The 460kbps versions can operate at full data rates with lengths of thousands of feet. Note that system jitter requirements may limit a network to shorter distances.

Use twisted pair cable for RS-422 networks. Twisted pair cables tend to pick up noise and other electromagnetically induced voltages as common-mode signals that are effectively rejected by the differential receivers in RS-422 ICs.

**Note:** Proper termination is imperative to minimize reflections when using the 10Mbps or 32Mbps devices. Short networks using the 460kbps versions do not need to be terminated, but terminations are recommended unless power dissipation is an overriding concern.

In point-to-point or point-to-multipoint (multiple receivers on bus) networks, terminate the main cable in its characteristic impedance (typically  $120\Omega$ ) at the end farthest from the driver. In multireceiver applications, keep stubs connecting receivers to the main cable as short as possible.

## Built-In Driver Overload Protection

The driver output stages incorporate short-circuit current limiting circuitry that ensures that the output current never exceeds the RS-422 specification. A novel design sets the short-circuit current limit depending on the  $V_{CC}$  value, so unlike some competing devices, the  $V_{CC} = 5\text{V}$  short-circuit current is only slightly higher than the corresponding  $V_{CC} = 3.3\text{V}$  level (see [Figure 13](#)).

In the event of a major short-circuit condition, the ISL32172E/32272E/32174E/32179E thermal shutdown feature disables the drivers whenever the die temperature becomes excessive. Thermal shutdown eliminates the power dissipation and allows the die to cool. The drivers automatically reenables after the die temperature drops about  $20^\circ$ . If the fault persists, the thermal shutdown/reenables cycle repeats until the fault is cleared.

## High Temperature Operation

With  $T_A = +125^\circ\text{C}$  and  $V_{CC} = 5.5\text{V}$ , four  $100\Omega$  differentially terminated drivers in the TSSOP package put the IC at the edge of its maximum allowed junction temperature. Using larger termination resistors, a lower maximum supply voltage, or one of the packages with a lower thermal resistance ( $\theta_{JA}$ ) provides more safety margin. When designing for  $+125^\circ\text{C}$  operation, measure the application's switching current and include it in the thermal calculations.

## Low Power Shutdown Mode (ISL32179E Only)

These BiCMOS transmitters all use a fraction of the power required by their bipolar counterparts, but the ISL32179E includes a shutdown feature that reduces the already low quiescent  $I_{CC}$  by 90%. The ISL32179E enters shutdown whenever the SHDNEN pin is high and all four drivers are disabled (see ["Pin Descriptions" on page 5](#)). Note that the enable times from shutdown are longer than the enable times when the IC is not in shutdown mode.



## Die Characteristics

### SUBSTRATE AND QFN THERMAL PAD POTENTIAL (POWERED UP):

GND

### TRANSISTOR COUNT:

1682

### PROCESS:

Si Gate BiCMOS

## Revision History

The revision history provided is for informational purposes only and is believed to be accurate, but not warranted. Please go to the web to make sure that you have the latest revision.

DATE	REVISION	CHANGE
Mar 19, 2020	4.01	Updated the Pin Configurations. Updated the readability of the Test Conditions for the Input High Voltage and Input Low Voltage specifications. Updated Figure 34.
Feb 1, 2019	4.00	Updated typical application diagrams on page 2. Updated disclaimer.
May 1, 2018	3.00	Removed ISL32372E, ISL32274E, and ISL32374E information from datasheet. Changed 1st sentence in 3rd paragraph on front page. Added Related Literature section. Ordering Information table - added tape and reel quantity column and updated Note 1. Changed part number in pin description for EN12, EN34 from ISL32x74E to ISL32774E. Changed Note 4 regarding the use of unused enable pins. Changed part numbers in Figure 2 from ISL32x75E to ISL32173E and from ISL32x74E to ISL32174E. Changed part number in 1st paragraph of Driver Enable Functions from ISL32x74E to ISL32174E. Removed the About Intersil section and updated the disclaimer. Updated POD M16.15 to the latest revision. Changes from previous are as follows: Updated graphics to new standard layout, removing the dimension table
Aug 13, 2015	2.00	Updated Table 1, page 1 and Ordering Information table on page 3 with "(No longer available or supported)" to applicable parts. Updated "About Intersil" section.
Feb 28, 2013	1.00	Added "EP" and description to "Pin Descriptions" on page 5. Added verbiage to clarify that $V_{CC}$ and $V_L$ may power up simultaneously, when powered from the same supply ("Pin Descriptions" table entries " $V_{CC}$ " and " $V_L$ " on page 5; "Notes" near bottom of page 2; "Note" under "Logic Supply" heading on page 15). Added "Revision History" table, and "About Intersil" sections to page 17.
De 16, 2008	0.00	Initial release.

# Package Outline Drawings

For the most recent package outline drawing, see [L24.4x4C](#).

L24.4x4C

24 Lead Quad Flat No-Lead Plastic Package

Rev 2, 10/06

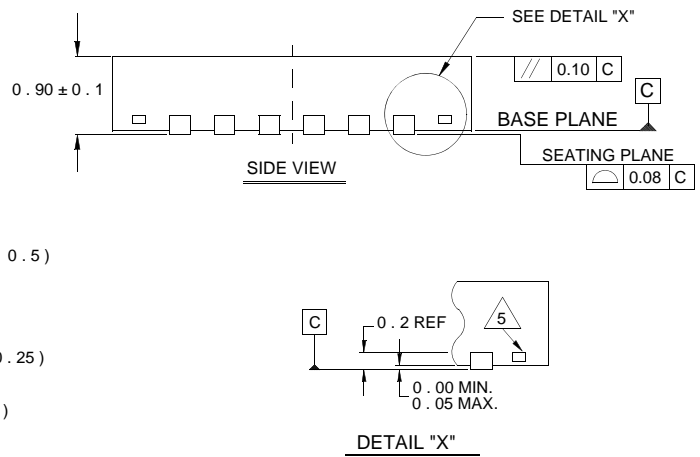
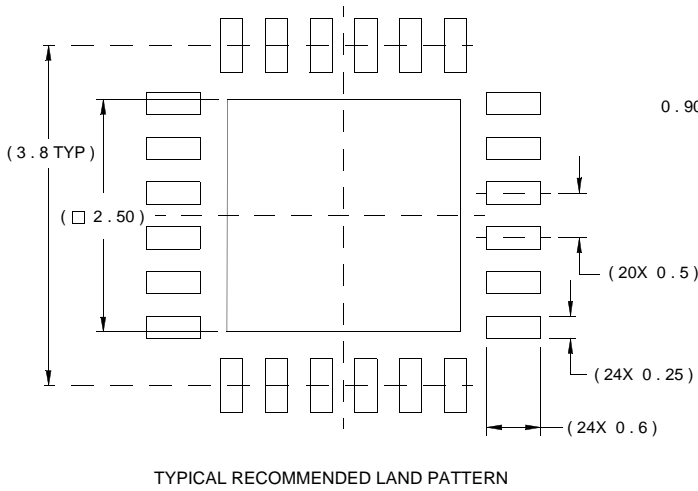
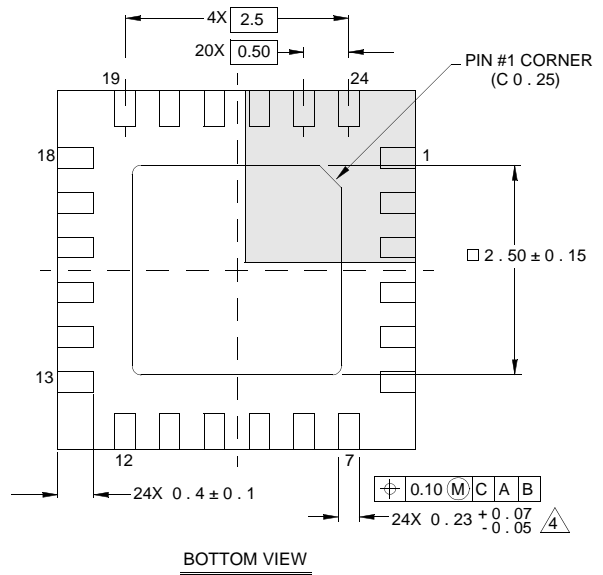
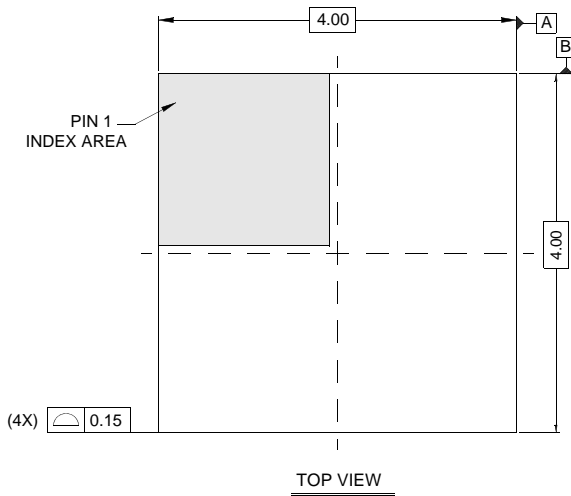

**NOTES:**

1. Dimensions are in millimeters.  
Dimensions in ( ) for Reference Only.
2. Dimensioning and tolerancing conform to AMSE Y14.5m-1994.
3. Unless otherwise specified, tolerance : Decimal ± 0.05
4. Dimension b applies to the metallized terminal and is measured between 0.15mm and 0.30mm from the terminal tip.
5. Tiebar shown (if present) is a non-functional feature.
6. The configuration of the pin #1 identifier is optional, but must be located within the zone indicated. The pin #1 identifier may be either a mold or mark feature.

**M16.15 (JEDEC MS-012-AC ISSUE C)**

16 Lead Narrow Body Small Outline Plastic Package  
 Rev 2, 11/17

For the most recent package outline drawing, see [M16.15](#).

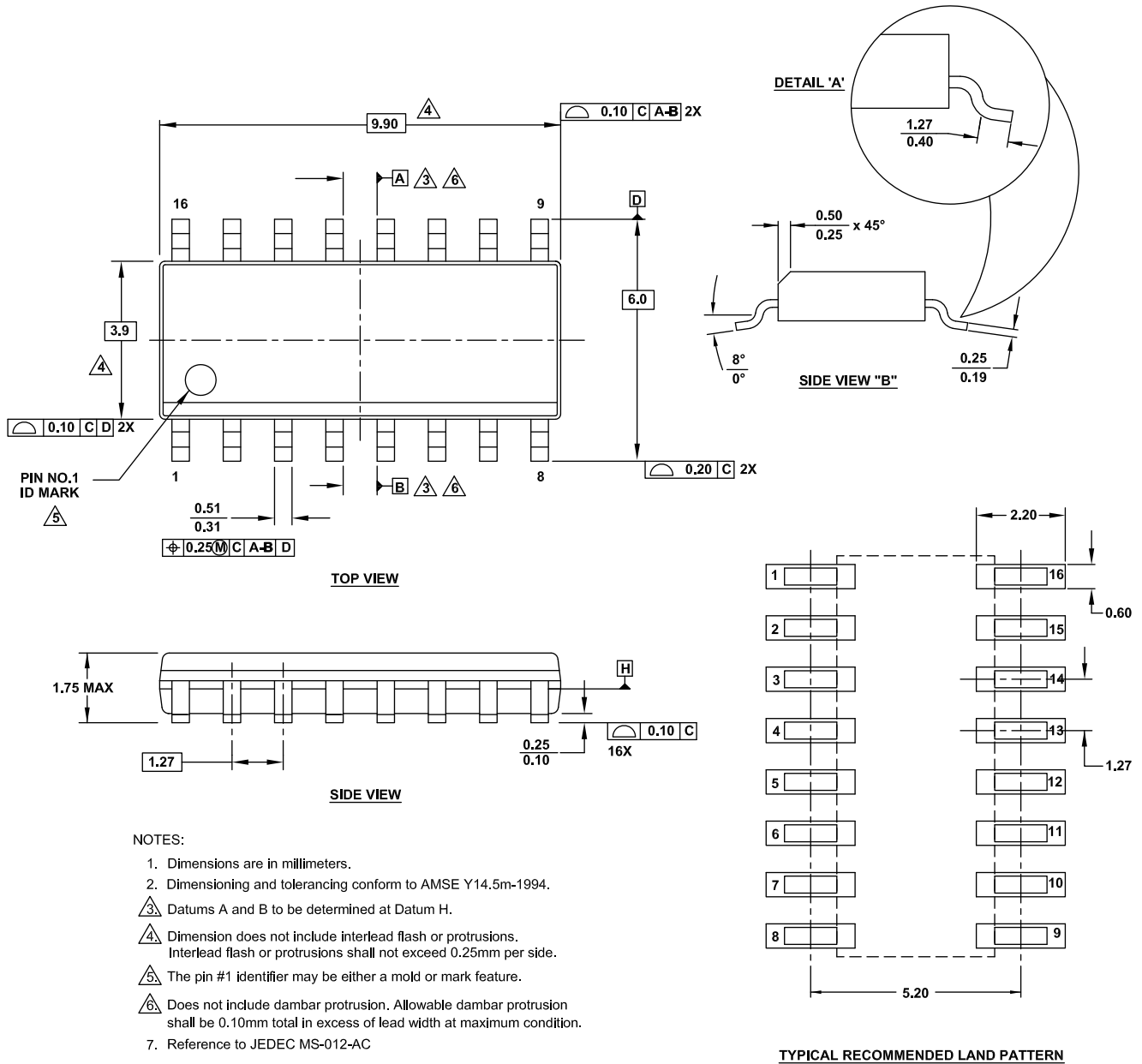

Thin Shrink Small Outline Package Family (TSSOP)

MDP0044 For the most recent package outline drawing, see [MDP0044](#).

Thin Shrink Small Outline Package Family

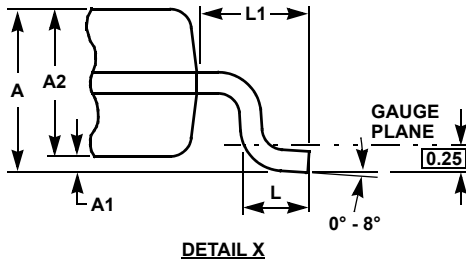
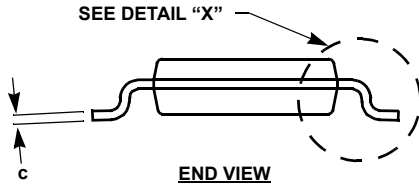
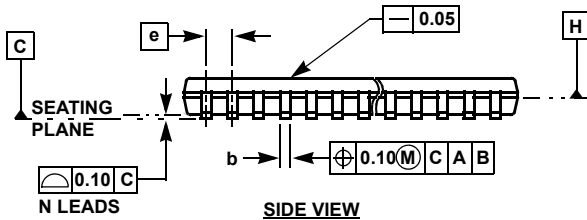
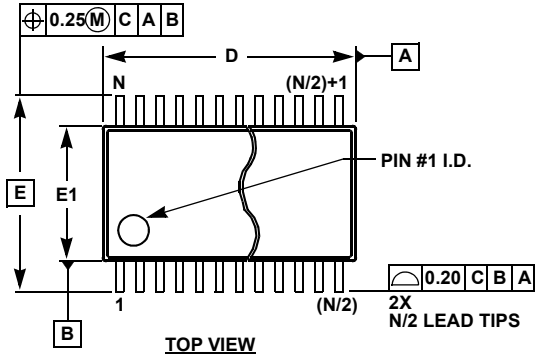

SYMBOL	MILLIMETERS					TOLERANCE
	14 LD	16 LD	20 LD	24 LD	28 LD	
A	1.20	1.20	1.20	1.20	1.20	Max
A1	0.10	0.10	0.10	0.10	0.10	±0.05
A2	0.90	0.90	0.90	0.90	0.90	±0.05
b	0.25	0.25	0.25	0.25	0.25	+0.05/-0.06
c	0.15	0.15	0.15	0.15	0.15	+0.05/-0.06
D	5.00	5.00	6.50	7.80	9.70	±0.10
E	6.40	6.40	6.40	6.40	6.40	Basic
E1	4.40	4.40	4.40	4.40	4.40	±0.10
e	0.65	0.65	0.65	0.65	0.65	Basic
L	0.60	0.60	0.60	0.60	0.60	±0.15
L1	1.00	1.00	1.00	1.00	1.00	Reference

Rev. F 2/07

NOTES:

1. Dimension "D" does not include mold flash, protrusions or gate burrs. Mold flash, protrusions or gate burrs shall not exceed 0.15mm per side.
2. Dimension "E1" does not include interlead flash or protrusions. Interlead flash and protrusions shall not exceed 0.25mm per side.
3. Dimensions "D" and "E1" are measured at dAtum Plane H.
4. Dimensioning and tolerancing per ASME Y14.5M-1994.

## Notice

1. Descriptions of circuits, software and other related information in this document are provided only to illustrate the operation of semiconductor products and application examples. You are fully responsible for the incorporation or any other use of the circuits, software, and information in the design of your product or system. Renesas Electronics disclaims any and all liability for any losses and damages incurred by you or third parties arising from the use of these circuits, software, or information.
2. Renesas Electronics hereby expressly disclaims any warranties against and liability for infringement or any other claims involving patents, copyrights, or other intellectual property rights of third parties, by or arising from the use of Renesas Electronics products or technical information described in this document, including but not limited to, the product data, drawings, charts, programs, algorithms, and application examples.
3. No license, express, implied or otherwise, is granted hereby under any patents, copyrights or other intellectual property rights of Renesas Electronics or others.
4. You shall not alter, modify, copy, or reverse engineer any Renesas Electronics product, whether in whole or in part. Renesas Electronics disclaims any and all liability for any losses or damages incurred by you or third parties arising from such alteration, modification, copying or reverse engineering.
5. Renesas Electronics products are classified according to the following two quality grades: "Standard" and "High Quality". The intended applications for each Renesas Electronics product depends on the product's quality grade, as indicated below.
  - "Standard": Computers; office equipment; communications equipment; test and measurement equipment; audio and visual equipment; home electronic appliances; machine tools; personal electronic equipment; industrial robots; etc.
  - "High Quality": Transportation equipment (automobiles, trains, ships, etc.); traffic control (traffic lights); large-scale communication equipment; key financial terminal systems; safety control equipment; etc.Unless expressly designated as a high reliability product or a product for harsh environments in a Renesas Electronics data sheet or other Renesas Electronics document, Renesas Electronics products are not intended or authorized for use in products or systems that may pose a direct threat to human life or bodily injury (artificial life support devices or systems; surgical implantations; etc.), or may cause serious property damage (space system; undersea repeaters; nuclear power control systems; aircraft control systems; key plant systems; military equipment; etc.). Renesas Electronics disclaims any and all liability for any damages or losses incurred by you or any third parties arising from the use of any Renesas Electronics product that is inconsistent with any Renesas Electronics data sheet, user's manual or other Renesas Electronics document.
6. When using Renesas Electronics products, refer to the latest product information (data sheets, user's manuals, application notes, "General Notes for Handling and Using Semiconductor Devices" in the reliability handbook, etc.), and ensure that usage conditions are within the ranges specified by Renesas Electronics with respect to maximum ratings, operating power supply voltage range, heat dissipation characteristics, installation, etc. Renesas Electronics disclaims any and all liability for any malfunctions, failure or accident arising out of the use of Renesas Electronics products outside of such specified ranges.
7. Although Renesas Electronics endeavors to improve the quality and reliability of Renesas Electronics products, semiconductor products have specific characteristics, such as the occurrence of failure at a certain rate and malfunctions under certain use conditions. Unless designated as a high reliability product or a product for harsh environments in a Renesas Electronics data sheet or other Renesas Electronics document, Renesas Electronics products are not subject to radiation resistance design. You are responsible for implementing safety measures to guard against the possibility of bodily injury, injury or damage caused by fire, and/or danger to the public in the event of a failure or malfunction of Renesas Electronics products, such as safety design for hardware and software, including but not limited to redundancy, fire control and malfunction prevention, appropriate treatment for aging degradation or any other appropriate measures. Because the evaluation of microcomputer software alone is very difficult and impractical, you are responsible for evaluating the safety of the final products or systems manufactured by you.
8. Please contact a Renesas Electronics sales office for details as to environmental matters such as the environmental compatibility of each Renesas Electronics product. You are responsible for carefully and sufficiently investigating applicable laws and regulations that regulate the inclusion or use of controlled substances, including without limitation, the EU RoHS Directive, and using Renesas Electronics products in compliance with all these applicable laws and regulations. Renesas Electronics disclaims any and all liability for damages or losses occurring as a result of your noncompliance with applicable laws and regulations.
9. Renesas Electronics products and technologies shall not be used for or incorporated into any products or systems whose manufacture, use, or sale is prohibited under any applicable domestic or foreign laws or regulations. You shall comply with any applicable export control laws and regulations promulgated and administered by the governments of any countries asserting jurisdiction over the parties or transactions.
10. It is the responsibility of the buyer or distributor of Renesas Electronics products, or any other party who distributes, disposes of, or otherwise sells or transfers the product to a third party, to notify such third party in advance of the contents and conditions set forth in this document.
11. This document shall not be reprinted, reproduced or duplicated in any form, in whole or in part, without prior written consent of Renesas Electronics.
12. Please contact a Renesas Electronics sales office if you have any questions regarding the information contained in this document or Renesas Electronics products.

(Note1) "Renesas Electronics" as used in this document means Renesas Electronics Corporation and also includes its directly or indirectly controlled subsidiaries.

(Note2) "Renesas Electronics product(s)" means any product developed or manufactured by or for Renesas Electronics.

(Rev.4.0-1 November 2017)

## Corporate Headquarters

TOYOSU FORESIA, 3-2-24 Toyosu,  
Koto-ku, Tokyo 135-0061, Japan  
[www.renesas.com](http://www.renesas.com)

## Contact Information

For further information on a product, technology, the most up-to-date version of a document, or your nearest sales office, please visit:  
[www.renesas.com/contact/](http://www.renesas.com/contact/)

## Trademarks

Renesas and the Renesas logo are trademarks of Renesas Electronics Corporation. All trademarks and registered trademarks are the property of their respective owners.

Компания «Океан Электроники» предлагает заключение долгосрочных отношений при поставках импортных электронных компонентов на взаимовыгодных условиях!

Наши преимущества:

- Поставка оригинальных импортных электронных компонентов напрямую с производств Америки, Европы и Азии, а так же с крупнейших складов мира;
- Широкая линейка поставок активных и пассивных импортных электронных компонентов (более 30 млн. наименований);
- Поставка сложных, дефицитных, либо снятых с производства позиций;
- Оперативные сроки поставки под заказ (от 5 рабочих дней);
- Экспресс доставка в любую точку России;
- Помощь Конструкторского Отдела и консультации квалифицированных инженеров;
- Техническая поддержка проекта, помощь в подборе аналогов, поставка прототипов;
- Поставка электронных компонентов под контролем ВП;
- Система менеджмента качества сертифицирована по Международному стандарту ISO 9001;
- При необходимости вся продукция военного и аэрокосмического назначения проходит испытания и сертификацию в лаборатории (по согласованию с заказчиком);
- Поставка специализированных компонентов военного и аэрокосмического уровня качества (Xilinx, Altera, Analog Devices, Intersil, Interpoint, Microsemi, Actel, Aeroflex, Peregrine, VPT, Syfer, Eurofarad, Texas Instruments, MS Kennedy, Miteq, Cobham, E2V, MA-COM, Hittite, Mini-Circuits, General Dynamics и др.);

Компания «Океан Электроники» является официальным дистрибьютором и эксклюзивным представителем в России одного из крупнейших производителей разъемов военного и аэрокосмического назначения «JONHON», а так же официальным дистрибьютором и эксклюзивным представителем в России производителя высокотехнологичных и надежных решений для передачи СВЧ сигналов «FORSTAR».



## JONHON

«JONHON» (основан в 1970 г.)

Разъемы специального, военного и аэрокосмического назначения:

(Применяются в военной, авиационной, аэрокосмической, морской, железнодорожной, горно- и нефтедобывающей отраслях промышленности)

«FORSTAR» (основан в 1998 г.)

ВЧ соединители, коаксиальные кабели, кабельные сборки и микроволновые компоненты:

(Применяются в телекоммуникациях гражданского и специального назначения, в средствах связи, РЛС, а так же военной, авиационной и аэрокосмической отраслях промышленности).



Телефон: 8 (812) 309-75-97 (многоканальный)

Факс: 8 (812) 320-03-32

Электронная почта: [ocean@oceanchips.ru](mailto:ocean@oceanchips.ru)

Web: <http://oceanchips.ru/>

Адрес: 198099, г. Санкт-Петербург, ул. Калинина, д. 2, корп. 4, лит. А