

M SERIES connectors Catalog

M-2012-01-1

NORTH AMERICA:

Amphenol Industrial Operations

40-60 Delaware Street
Sidney, New York 13838-1395 - USA
Telephone: 1-607-563-5011 • Fax: 1-607-563-5157
www.amphenol-industrial.com

Amphenol Industrial Operations Amphenol Power Solutions

34190 Riviera Drive
Fraser, MI 48026 - USA
Telephone: 1-586-294-7400 • Fax: 1-586-294-7402
www.radsok.com

Amphenol Technical Products International Co.

2110 Notre Dame Avenue
Winnipeg, MB Canada R3H 0K1
Telephone: 1-204-697-2222 • Fax: 1-204-694-6164
www.tpil.com

Amphenol Steward Cable, Inc.

1921 Alta Vista - Midland, Texas 79706 - USA
P.O. Box 11270 - Midland, Texas 79702 - USA
Telephone: 1-432-687-2553 • Fax: 1-432-687-2278
www.stewardcable.com

ASIA:

安费诺科技（深圳）有限公司

Amphenol Technology (shenzhen) Co., Ltd
地址：深圳市宝安区福永大洋路福安第三工业城第五栋
Block 5, FuAn 2nd Industrial Park,
Dayang Road, Fuyong, Shenzhen - China 518103
电话: 0755-2991-8389 Telephone: 0755-2991-8389
传真: 0755-2991-8310 Fax: 0755-2991-8310
www.amphenol-industrial.com.cn
e-mail: enquiry@amphenol-industrial.com

广州安费诺诚信软件性电路有限公司

Amphenol Sincere Flex Circuits Co. Ltd
地址：广州市番禺区榄核镇万安工业区A栋
No. A, WanAn Industrial Park
LanHe Town, Panyu District, Guangzhou - China 511480
Tel: +9716-7422494 / Fax: +9716-7422941
/ Cell: +97150-6310566
www.amphenol-gesf.com

安费诺科技（珠海）有限公司

Amphenol Technology (zhuhai) Co., Ltd
地址：珠海市金湾区三灶镇二期科技工业园
Address: Phase 2, Sanzao Science and technology
Industrial Park, Sanzao Town, Jinwan, Zhuhai, PRC
电话: (86)756-3989725 Tel: (86)756-3989725
传真: (86)756-3989768 Fax: (86)756-3989768

Amphenol Middle East Enterprises Fze

Office no c-37 po box 21107, ajman free
Zone, united arab emirates
Tel: +9716-7422494 / Fax: +9716-7422941
/ Cell: +97150-6310566
e-mail: jhussain@amphenol-ase.com



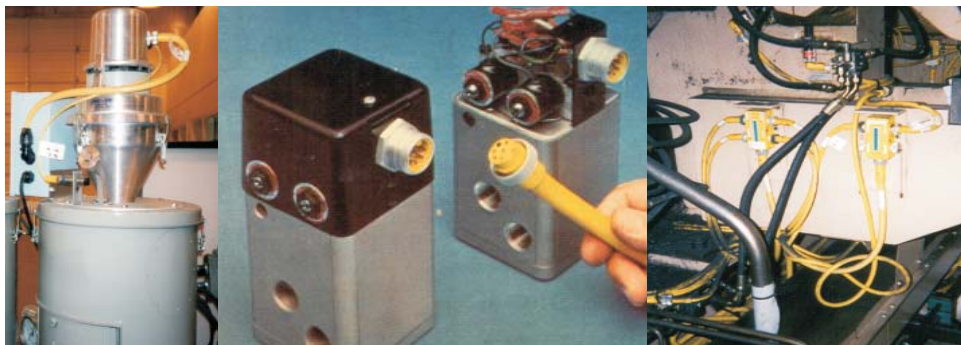
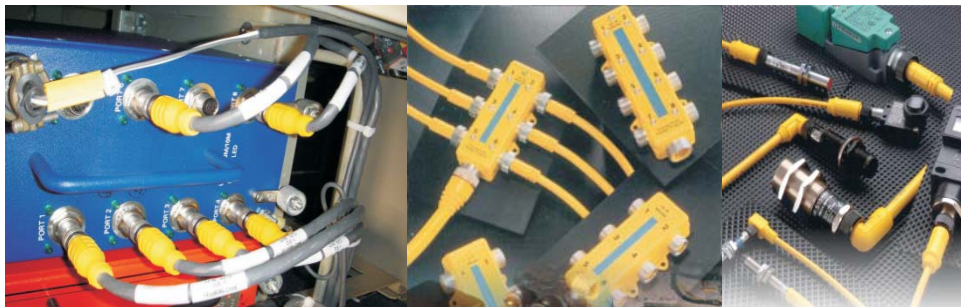

Background:

Amphenol Industrial Operation (AIO) can provide its reliable connection products and the connection solutions. AIO is now manufacturing the range of M8, M12, circular connector, meet UL 1977 & IEC 61076-2-101 standards, the connection products are widely used in field bus components, Ethernet, solenoid valves, pressure switches, motors-control, Encoder, HMI, photoelectric barriers, flow monitoring devices, and sensors in the hydraulic and automation industries, all kind of electronic equipment connection.

TABLE OF CONTENTS

Table of contents	Page No.
Application/M12 specification	01
Insert arrangement.....	02
How to order for receptacle.....	03
PCB layout.....	04
Part number & drawing for receptacle	5~11
How to order for plug.....	12
Part number & drawing for plug	13~19
Max-M12 specification	20
Insert arrangement.....	21
How to order	22
Part number & drawing	23~26
M8 specification	27
Insert arrangement/How to order.....	28
Part number & drawing	29~31
Cable assembly install instruction.....	32

APPLICATION

1. INVERTER
2. DATA/TELECOM
3. SMART GRID POWER
4. CONTROL/AUTOMATION
5. INDUSTRIAL INSTRUMENTATION
6. RAIL & MASS TRANSIT

M12 SPECIFICATION

Mechanical data

- Durability: 500 Cycles
- Salt Spray: 720 Hours different plating and base material
- Sealing Requirement: IP 67/IP68(mated)
- Operating temperature: -40°C~+100°C

Standards

- Connectors: IEC 61076-2-101

Electrical

- Contact Resistance: $\leq 5\text{m}\Omega$
- Insulation Resistance: $> 20\text{M}\Omega$
- Rated Current: (3, 4, and 5 pole) = 4A, (8pole) = 2A
- Operate Voltage:
 - (3 and 4 pole) = 250V AC/DC,
 - (5 pole) = 60V AC/DC,
 - (8 pole) = 30V AC/DC

Material

- Shell, Screw/Nut: Copper, Zinc, or Aluminum Alloy
- Contact: Brass with gold plating
- Insert: PA + Glass Filled meet UL 94V0
- Sealing: Epoxy Resin
- O-ring: NBR/SR

Cable characteristics:

- Material: UL certified PVC or customer requestment
- Cable size: 22AWG-20AWG, 3C, 4C, 5C & 8C
- Current rating: 4A
- Voltage rating: 250V AC/DC(3C, 4C), 60V AC/DC(5C), 30V(8C)
- Shielded/unshielded available.
- Heavy-duty application in harsh environments
- Highly resistant against abraion
- Good resistance against oil, lubricants, and coolants.
- Halogen free, hydrolysis and UV resistant.
- Flame retardant

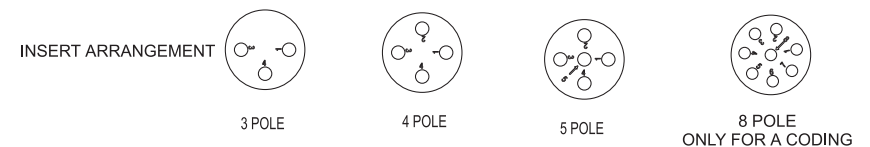
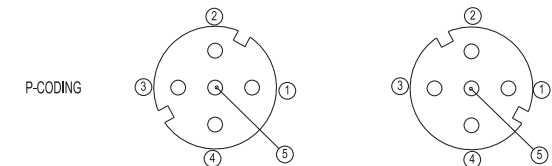
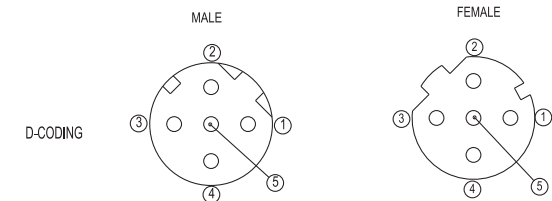
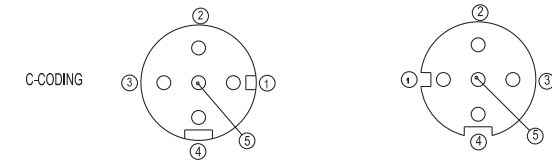
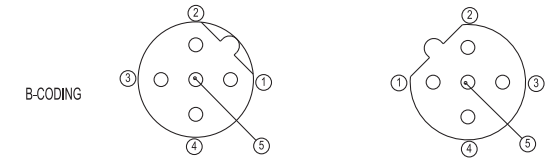
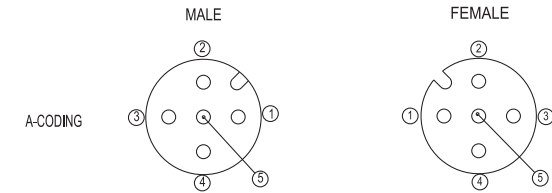

How to order

For Receptacle

CJE12	C	R	ST	04	S	W	A	PCG	R	Blank
1	2	3	4	5	6	7	8	9	10	11

1. CJE12 M12 x 1.0 thread locking

7. Contact connection type

P-----solder PCB
W-----Solder wire
S-----Screw
C-----Crimp

2. Shell, coupling nut material :

A-----Al Alloy
C-----Copper Alloy
Z-----Zn Alloy

8. Coding type

A-----A code only for 8 position
B-----B Code
D-----D code
C-----C Code
P-----P Code

3. Shell system

R-----Receptacle

9. Accessories type

PCG-----plastic cable gland
MCG-----Metal cable gland
Blank-----no Accessories

4. Backshell connection type

ST-----Straight
RA-----Right Angle (Solder PCB Inapplicability)

10. Panel lock type for receptacle

R-----Real lock
F-----Front lock

5. Insert arrangement

03, 04, 05, 08

11-----Contact finish

Blank-----Gold plated
2-----Silver plated
3-----Tin plated
4-----Nickel plated

6. Contact type

S-----female contact
P-----male contact

PCB LAYOUT

For Receptacle

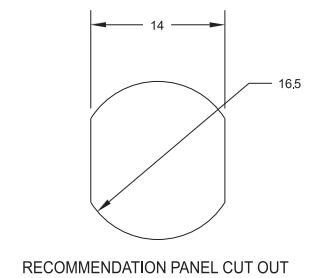
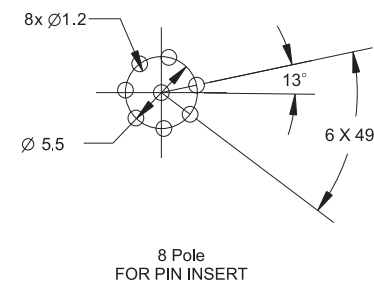
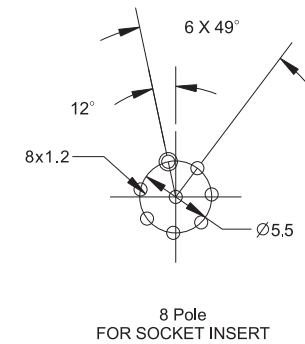
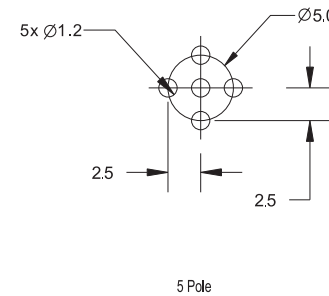
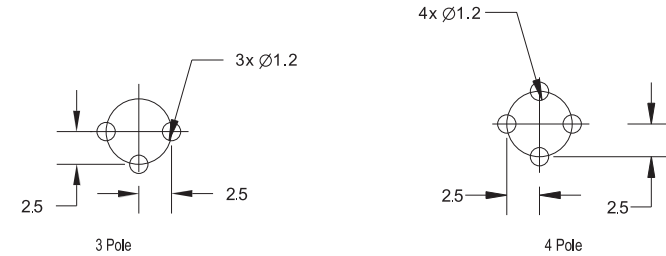

RECEPTACLE REAL LOCK MALE SOLDER TYPE

Part number

CJE12CRST_PW_R

- Blank (Gold) ,2,3,4 type contact available
- A,B,C,D,P code available
- 3,4,5,8 position available

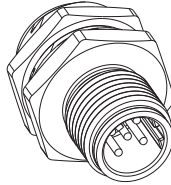

DIMENSIONS (Millimeters)

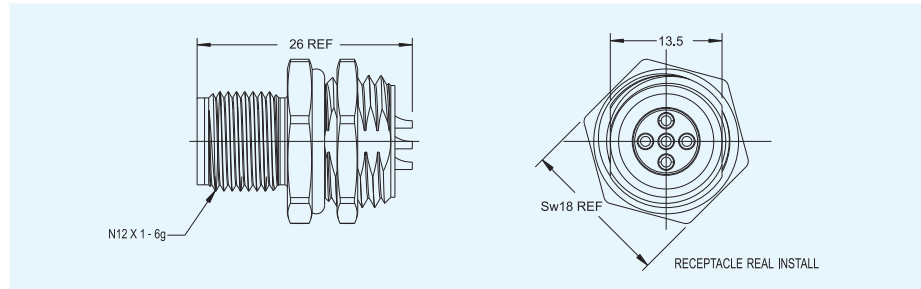

RECEPTACLE FRONT LOCK MALE SOLDER TYPE

part number

CJE12CRST_PW_F

- Blank (Gold) ,2,3,4 type contact available
- A,B,C,D,P code available
- 3,4,5,8 position available

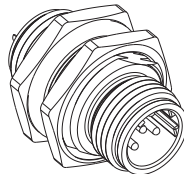

DIMENSIONS (Millimeters)

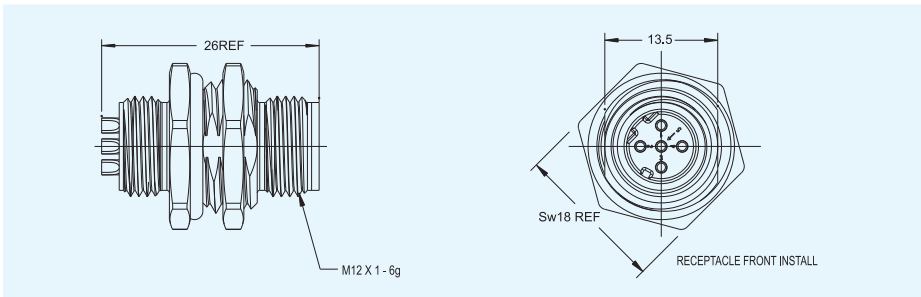

RECEPTACLE REAL LOCK FEMALE SOLDER TYPE

Part number

CJE12CRST_SW_R

- Blank (Gold) ,2,3,4 type contact available
- A,B,C,D,P code available
- 3,4,5,8 position available

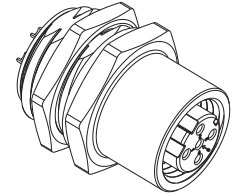

DIMENSIONS (Millimeters)

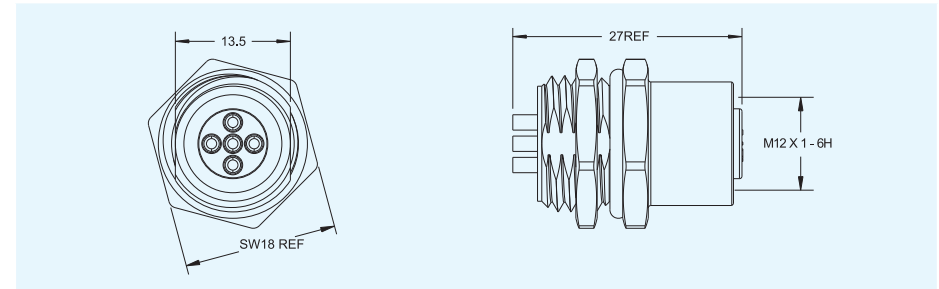

RECEPTACLE FRONT LOCK FEMALE SOLDER TYPE

part number

CJE12CRST_SW_F

- Blank (Gold) ,2,3,4 type contact available
- A,B,C,D,P code available
- 3,4,5,8 position available

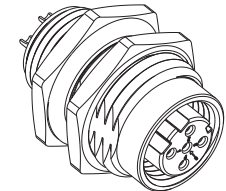

DIMENSIONS (Millimeters)

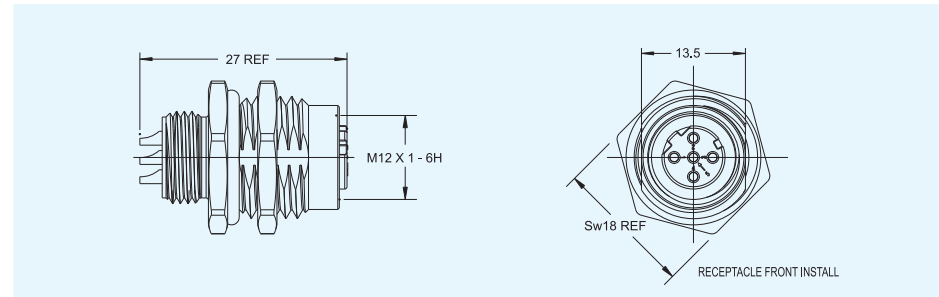

RECEPTACLE REAL LOCK MALE PCB TYPE

part number

CJE12CRST_PP_R

Blank (Gold) ,2,3,4 type contact available

A,B,C,D,P code available

3,4,5,8 position available

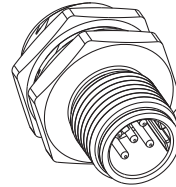

DIMENSIONS (Millimeters)

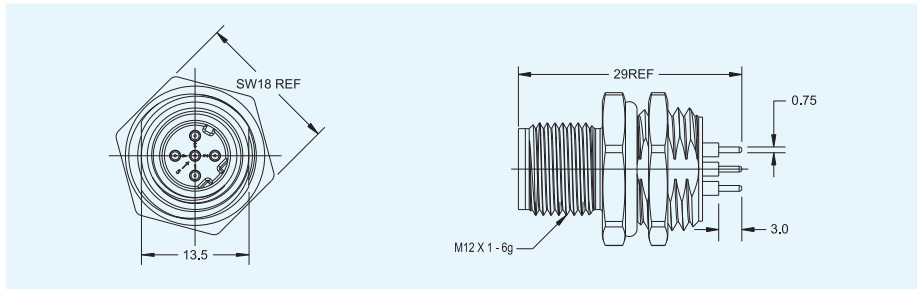

RECEPTACLE FRONT LOCK MALE PCB TYPE

part number

CJE12CRST_PP_F

Blank (Gold) ,2,3,4 type contact available

A,B,C,D,P code available

3,4,5,8 position available

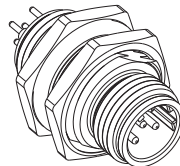

DIMENSIONS (Millimeters)

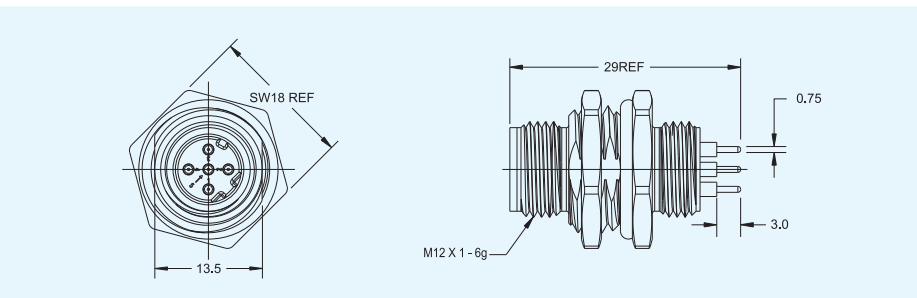

RECEPTACLE REAL LOCK FEMALE PCB TYPE

part number

CJE12CRST_SP_R

Blank (Gold) ,2,3,4 type contact available

A,B,C,D,P code available

3,4,5,8 position available

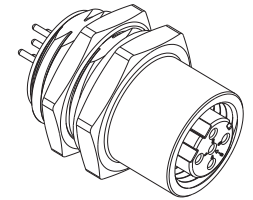

DIMENSIONS (Millimeters)

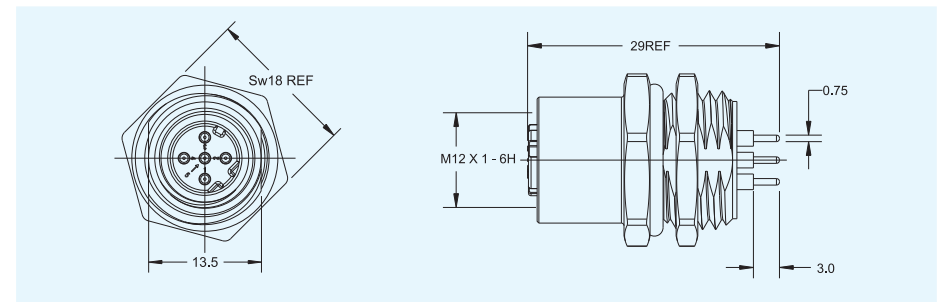

RECEPTACLE FRONT LOCK FEMALE PCB TYPE

part number

CJE12CRST_SP_F

Blank (Gold) ,2,3,4 type contact available

A,B,C,D,P code available

3,4,5,8 position available

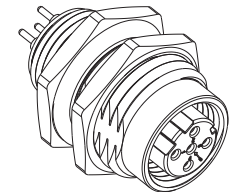

DIMENSIONS (Millimeters)

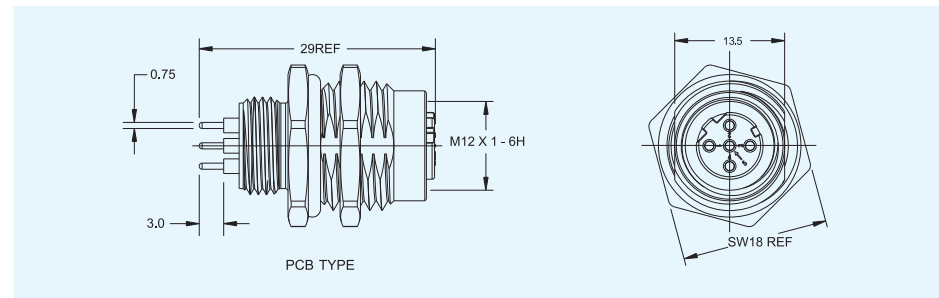

RECEPTACLE FRONT LOCK MALE SOLDER WITH PLASTIC CABLE GLAND

part number

CJE12RST_PW_FPCG

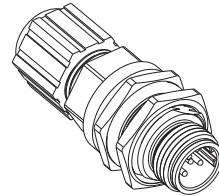
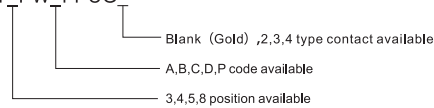

DIMENSIONS (Millimeters)

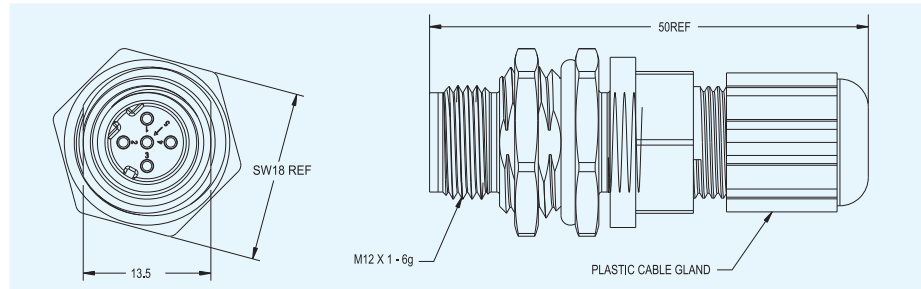

RECEPTACLE FRONT LOCK FEMALE SOLDER WITH PLASTIC CABLE GLAND

part number

CJE12RST_SW_FPCG

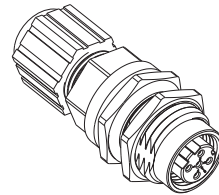
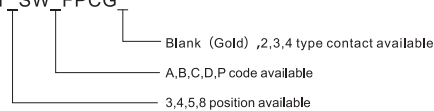

DIMENSIONS (Millimeters)

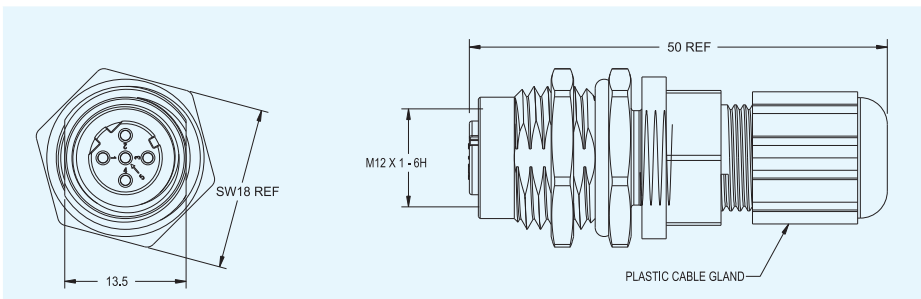

RECEPTACLE FRONT LOCK MALE SOLDER WITH METAL CABLE GLAND

part number

CJE12RST_PW_FMCG

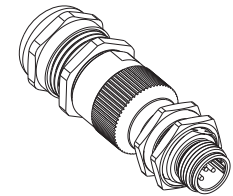
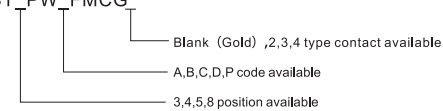

DIMENSIONS (Millimeters)

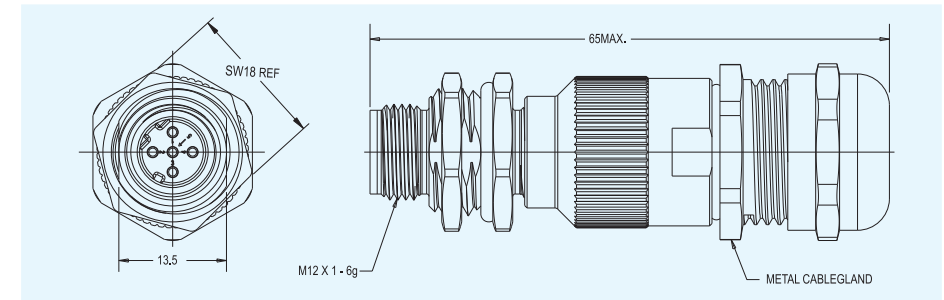

RECEPTACLE FRONT LOCK FEMALE SOLDER WITH METAL CABLE GLAND

part number

CJE12RST_SW_FMCG

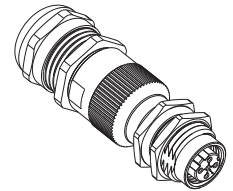
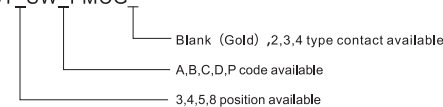

DIMENSIONS (Millimeters)

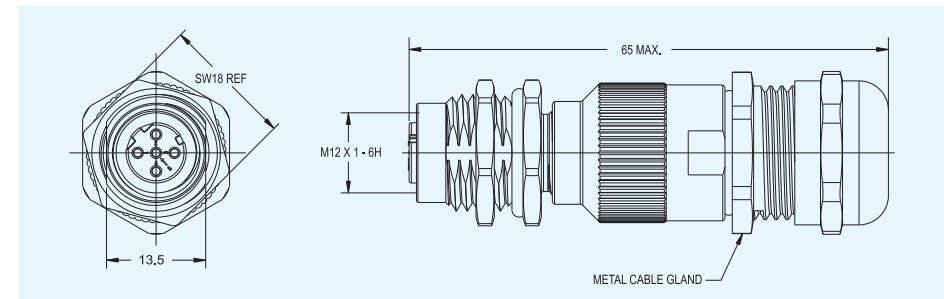

RECEPTACLE FRONT LOCK MALE WITH METAL CABLE GLAND & CABLE ASSEMBLY

part number

CJE12RST_PW_FMCGL

- Blank (Gold) ,2,3,4 type contact available
- For customer request cable length optional
- A,B,C,D,P code available
- 3,4,5,8 position available

DIMENSIONS (Millimeters)

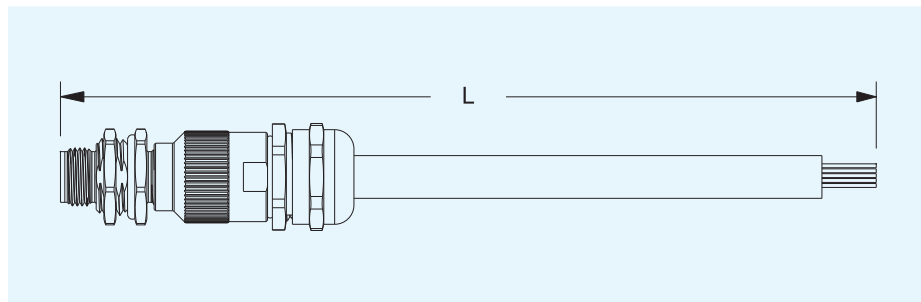

RECEPTACLE FRONT LOCK MALE WITH PLASTIC CABLE GLAND & CABLE ASSEMBLY

part number

CJE12RST_PW_FPCGL

- Blank (Gold) ,2,3,4 type contact available
- For customer request cable length optional
- A,B,C,D,P code available
- 3,4,5,8 position available

DIMENSIONS (Millimeters)

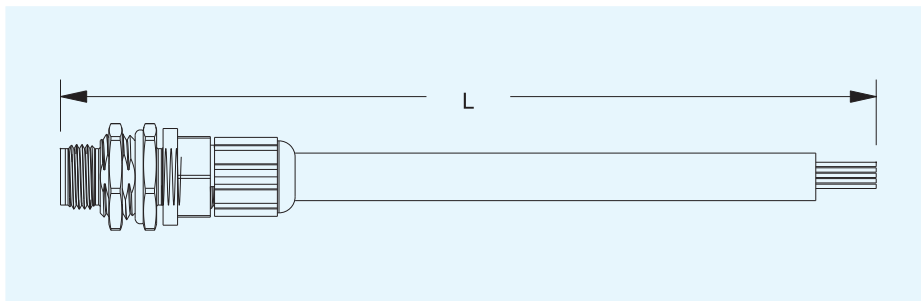

How to order

For Plug

CJE12	C	P	ST	04	S	W	A	PCG	L	Blank
1	2	3	4	5	6	7	8	9	10	11

1. CJE12 M12 x 1.0 thread locking

2. Shell, coupling nut material :

A-----Al Alloy
 C-----Copper Alloy
 Z-----Zn Alloy

3. Shell system

P-----Plug

4. Backshell connection type

ST-----straight
 RA-----Right Angle

5. Insert arrangement

03, 04, 05, 08

6. Contact type

S-----female contact
 P-----male contact

7. Contact connection type

W-----Solder wire
 C-----crimp
 S-----Screw

8 Coding type

A-----A code only for 8 position
 B-----B Code
 D-----D code
 C-----C Code
 P-----P code

9 Accessories type

PCG-----plastic cable gland
 MCG-----Metal cable gland
 Blank-----no Accessories

10. For cable assembly optional

Overmolding cable assembly ,length is optional
 L----for cable length, optional

11-----Contact finish

Blank-----Gold plated
 2-----Silver plated
 3-----Tin plated
 4-----Nickel plated

PLUG STRAIGHT MALE WITH PLASTIC CABLE GLAND

part number

CJE12CPST_PW_PCG

Blank (Gold) ,2,3,4 type contact available

A,B,C,D,P code available

3,4,5,8 position available

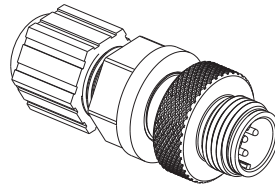

DIMENSIONS (Millimeters)

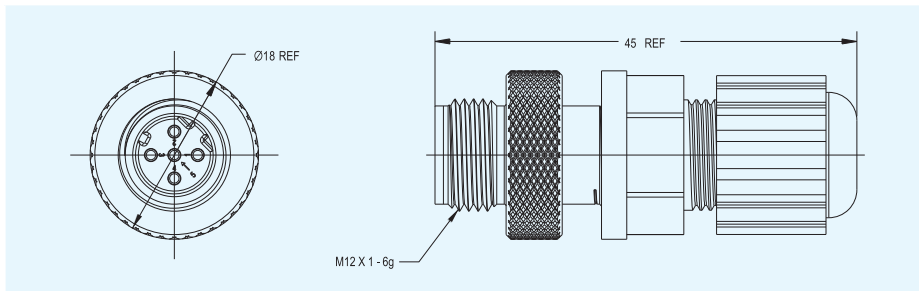

PLUG RIGHT ANGLE MALE WITH PLASTIC CABLE GLAND

part number

CJE12CPRA_PW_PCG

Blank (Gold) ,2,3,4 type contact available

A,B,C,D,P code available

3,4,5,8 position available

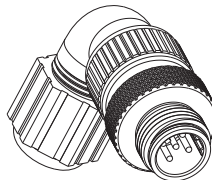

DIMENSIONS (Millimeters)

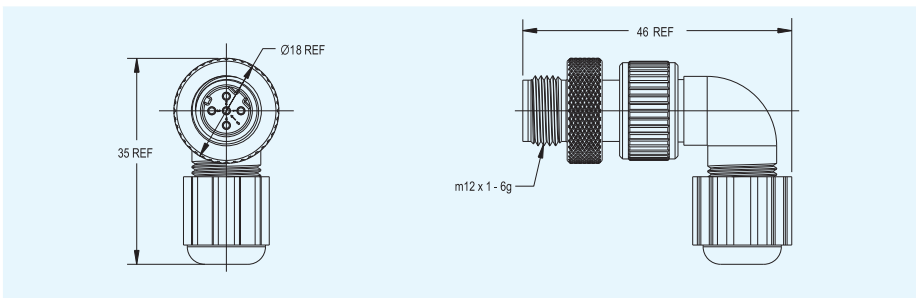

PLUG STRAIGHT FEMALE WITH PLASTIC CABLE GLAND

part number

CJE12CPST_SW_PCG

Blank (Gold) ,2,3,4 type contact available

A,B,C,D,P code available

3,4,5,8 position available

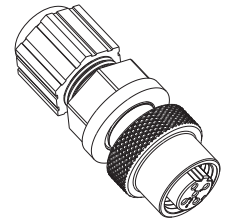

DIMENSIONS (Millimeters)

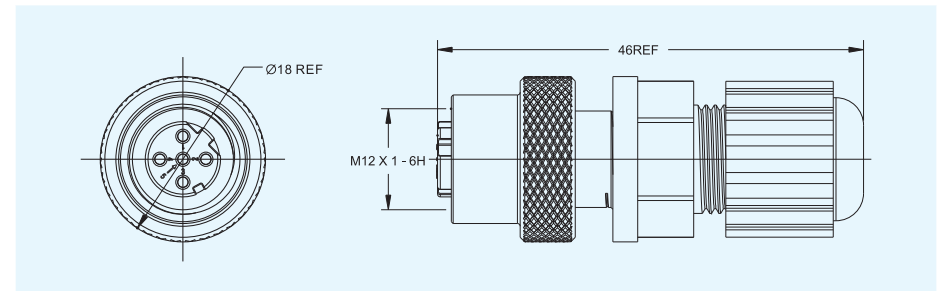

PLUG RIGHT ANGLE FEMALE WITH PLASTIC CABLE GLAND

part number

CJE12CPRA_SW_PCG

Blank (Gold) ,2,3,4 type contact available

A,B,C,D,P code available

3,4,5,8 position available

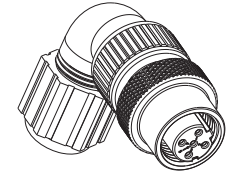

DIMENSIONS (Millimeters)

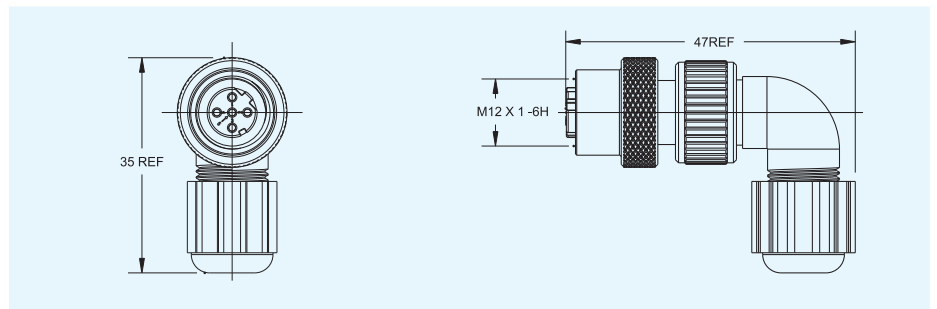

PLUG MALE

part number

CJE12CPST_PW

- Blank (Gold) ,2,3,4 type contact available
- A,B,C,D,P code available
- 3,4,5,8 position available

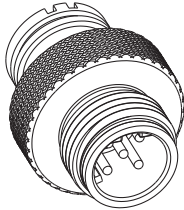

DIMENSIONS (Millimeters)

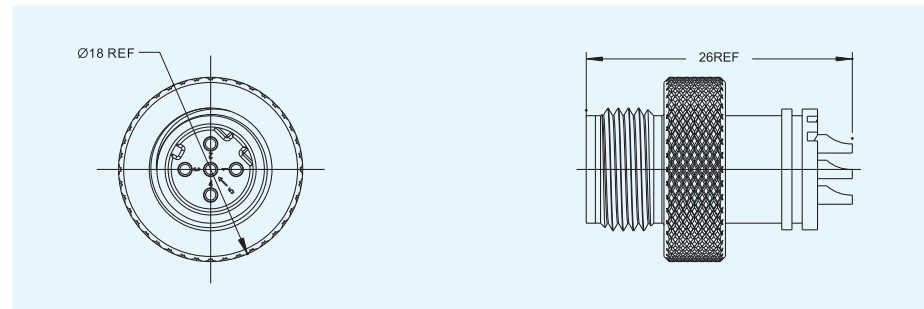

PLUG FEMALE

part number

CJE12CPST_SW

- Blank (Gold) ,2,3,4 type contact available
- A,B,C,D,P code available
- 3,4,5,8 position available

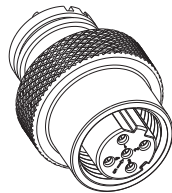

DIMENSIONS (Millimeters)

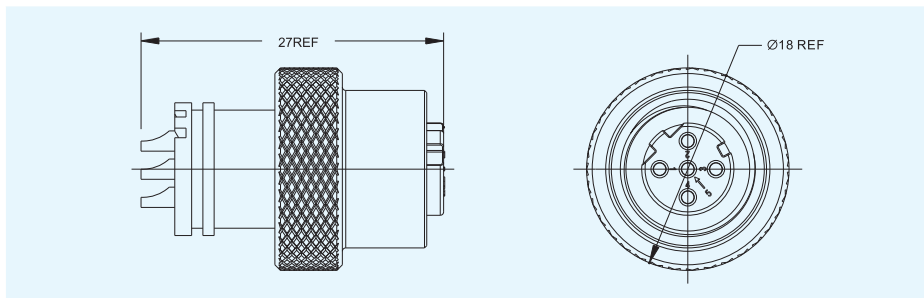

PLUG STRAIGHT MALE OVERMOLDING CABLE ASSEMBLY

part number

CJE12CPST_P L

- Blank (Gold) ,2,3,4 type contact available
- A,B,C,D,P code available
- Solder wire(W) / crimp(C) type available
- 3,4,5,8 position available

DIMENSIONS (Millimeters)

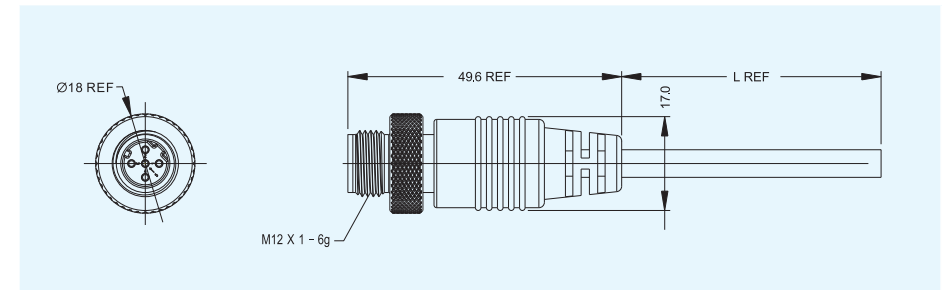

PLUG STRAIGHT FEMALE OVERMOLDING CABLE ASSEMBLY

part number

CJE12CPST_S L

- Blank (Gold) ,2,3,4 type contact available
- A,B,C,D,P code available
- Solder wire(W) / crimp(C) type available
- 3,4,5,8 position available

DIMENSIONS (Millimeters)

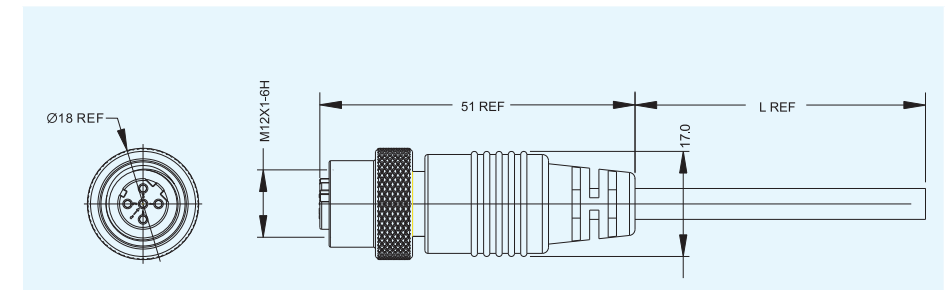

PLUG RIGHT ANGLE MALE OVERMOLDING CABLE ASSEMBLY

part number

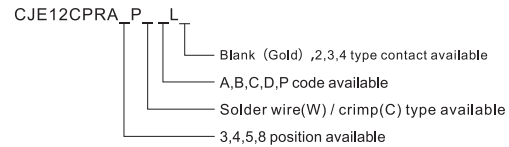

DIMENSIONS (Millimeters)

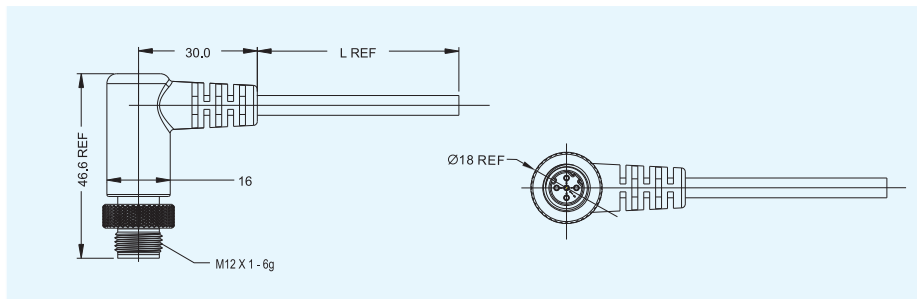

PLUG RIGHT ANGLE FEMALE OVERMOLDING CABLE ASSEMBLY

part number

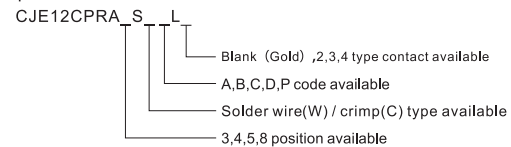

DIMENSIONS (Millimeters)

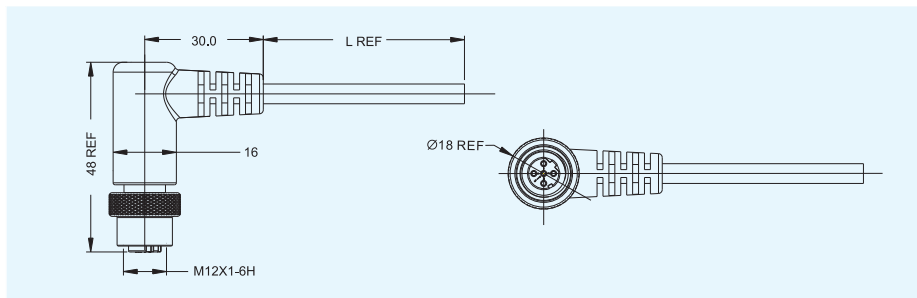

PLUG STRAIGHT MALE WITH METAL CABLE GLAND TYPE

part number.

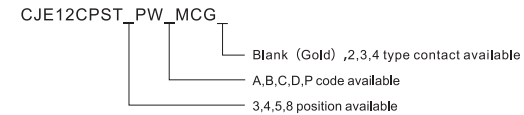

DIMENSIONS (Millimeters)

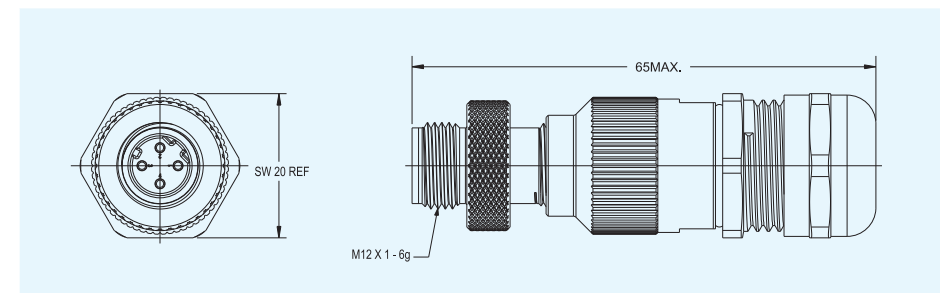

PLUG STRAIGHT FEMALE WITH METAL CABLE GLAND TYPE

part number .

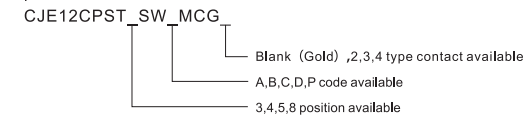

DIMENSIONS (Millimeters)

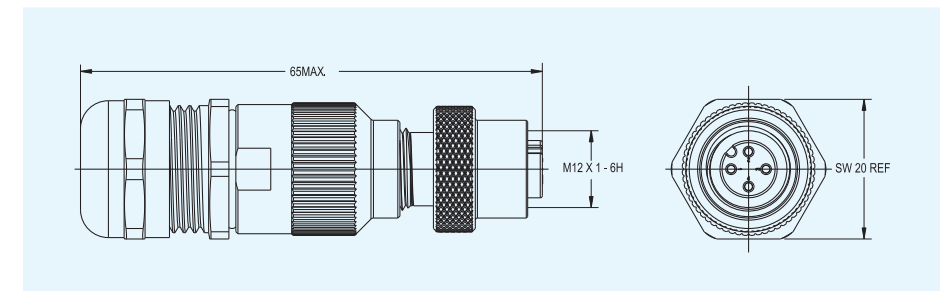

PLUG STRAIGHT FEMALE WITH PLASTIC CABLE GLAND & CABLE ASSEMBLY

part number.
CJE12CPST_SW_PCGL

- Blank (Gold) ,2,3,4 type contact available
- A,B,C,D,P code available
- 3,4,5,8 position available

DIMENSIONS (Millimeters)

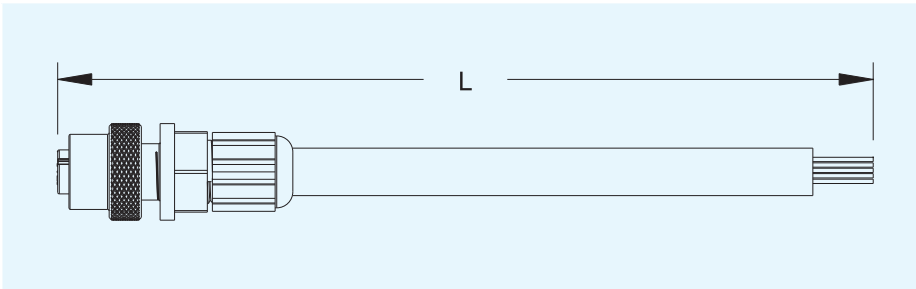

PLUG STRAIGHT FEMALE WITH METAL CABLE GLAND & CABLE ASSEMBLY

part number.
CJE12CPST_SW_MCGL

- Blank (Gold) ,2,3,4 type contact available
- A,B,C,D,P code available
- 3,4,5,8 position available

DIMENSIONS (Millimeters)

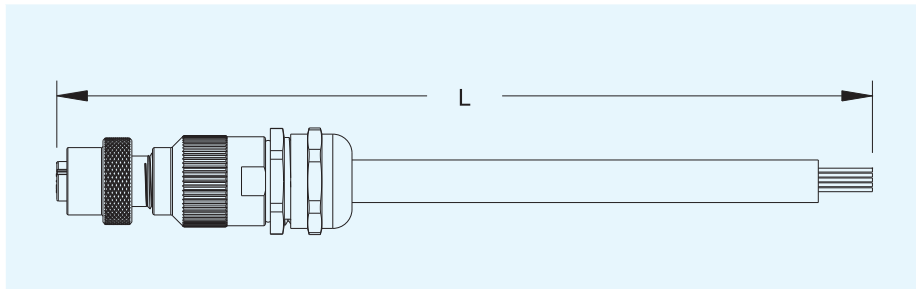

Max-M12 Connector

Electrical & Environmental Characteristics:

- SAE J 2839 Compliant
- IP 67 & IP 69 K Compliant
- Backward compatible with IEC 61076-2-101 (M12) with higher environmental rating
- Provisions for overall cable shield or drain wire to the connector plug housing
- Connection resistance – maximum millivolt drop of 50 millivolts



Operating Voltage	5 pin - 60V AC/DC 4 pin - 250V AC/DC	IEC 60664
Current Rating	4A MAX.	IEC 60512 TEST 5B
Temperature Rating	-40°C - +125°C	SAE J2030, 6 . 13
Dielectric Withstanding Voltage	1000V	IEC 60512, TEST 4A
Insulation Resistance	>20 Megohms	SAE J2030, 6 . 3
Rated Impulse Voltage	1500V	IEC 60664-1
Contact Resistance	<10 mΩ	IEC60512 TEST 2A
Vibration, Sine	10 - 2000 Hz, 20g, <1 us	SAE J2030, 6 . 15
Shock, Half Sine	10 CYCLES, 50g, 11mg, <1 us	SAE J2030, 6 . 16
Temperature Life	1000H AT 125°C + 3°C	SAE J2030, 6 . 6
Durability	50 CYCLES MIN.	SAE J2030, 6 . 11
Salt Fog	96H	SAE J2030, 6 . 12
Protection Class	IP67 and IP69K	IEC 60529
Wire Gauge	0.5 mm ² (20AWG) or 0.8 mm ² (18AWG)/ 0.75 mm ²	SAE J1128 / ISO 6722
Cable OD.	ø 12.7 MAX.	
Recommended Torque	M12 THREAD, 0.8 - 1.0 Nm	
Connector Retention	444 N MIN	SAE J2030, 6 . 20
Contact Retention	110 N MIN	SAE J2030, 6 . 18

Applications:

- Construction Machinery & Equipment
- Forestry Equipment
- Navigation, GPS and Telematics Applications
- Mining Machinery & Equipment
- Agricultural Machinery & Equipment
- Harsh Environment Sensors, Controllers, Actuators, Switches, etc.

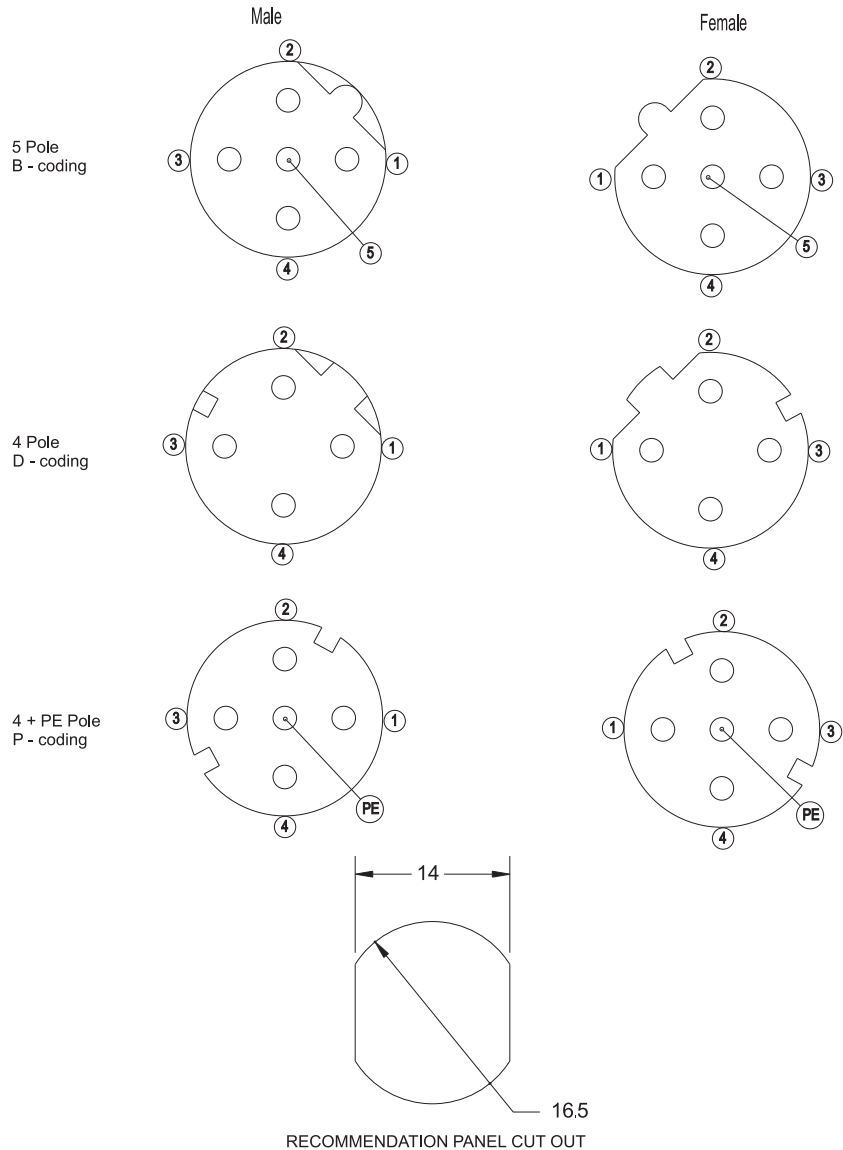

How to order

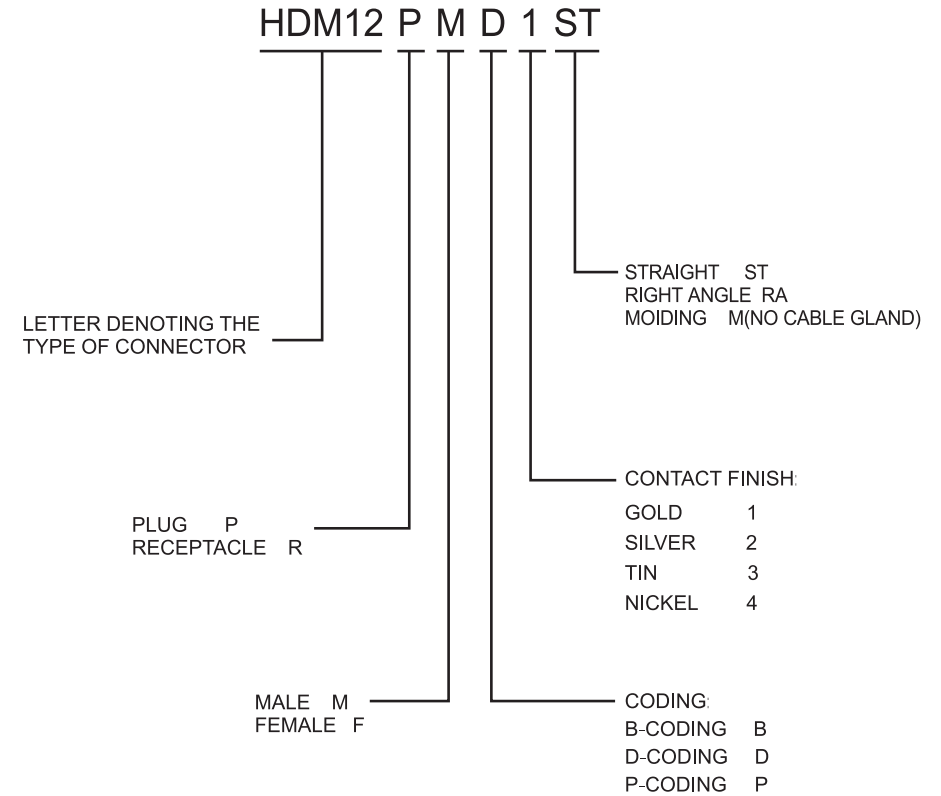

PLUG STRAIGHT MALE

part number

HDM12PM ST

1,2,3,4 type contact available

B,D,P, code available

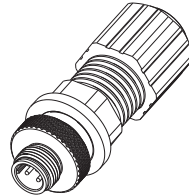

DIMENSIONS (Millimeters)

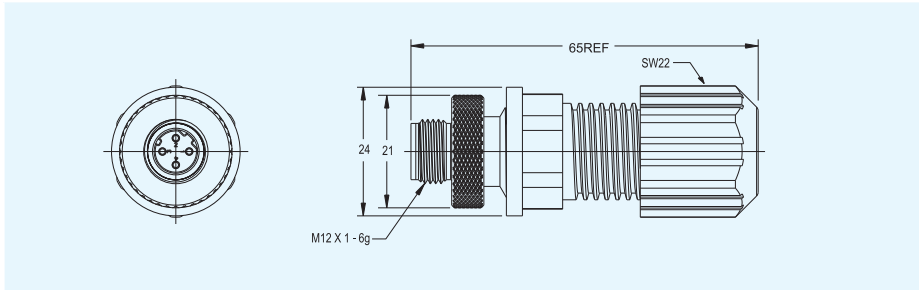

PLUG RIGHT ANGLE MALE

part number

HDM12PM RA

1,2,3,4 type contact available

B,D,P, code available

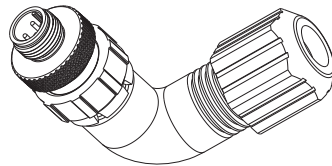

DIMENSIONS (Millimeters)

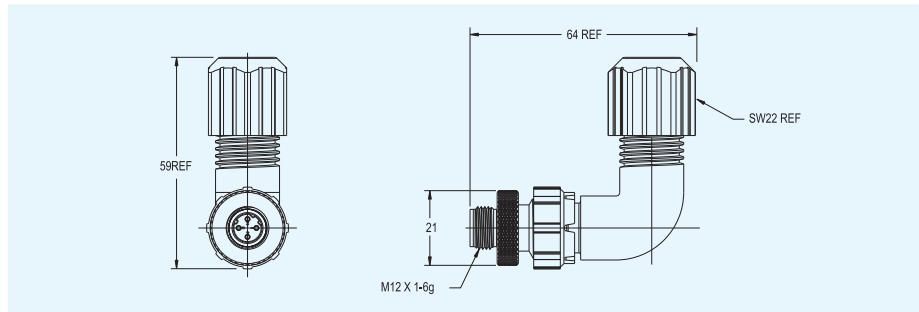

PLUG STRAIGHT FEMALE

part number

HDM12PF ST

1,2,3,4 type contact available

B,D,P, code available

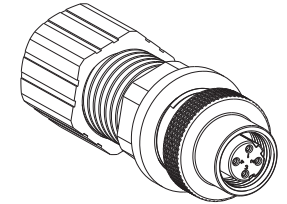

DIMENSIONS (Millimeters)

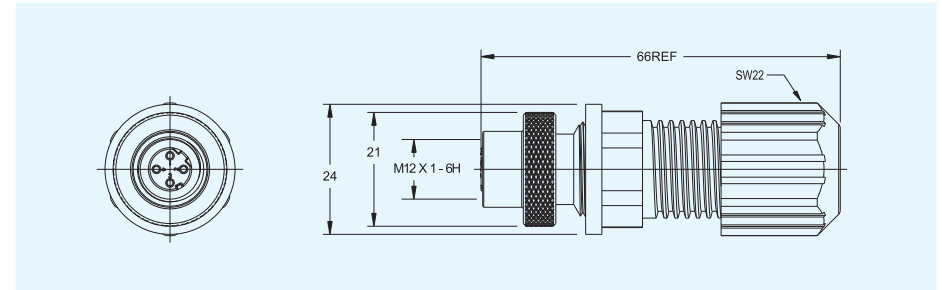

PLUG RIGHT ANGLE FEMALE

part number

HDM12PF RA

1,2,3,4 type contact available

B,D,P, code available

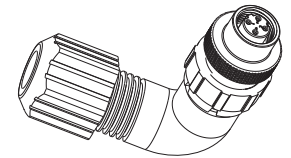

DIMENSIONS (Millimeters)

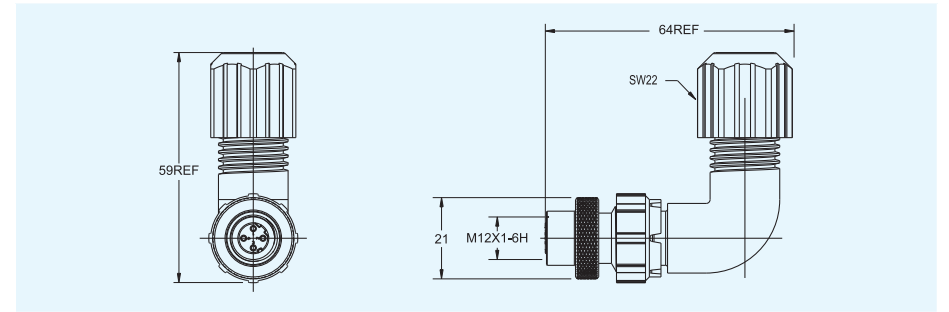

RECEPTACLE STRAIGHT MALE

part number

HDM12RM _ST

1,2,3,4 type contact available

B,D,P, code available

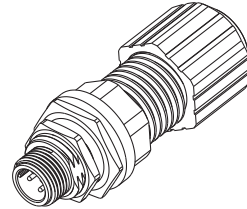

DIMENSIONS (Millimeters)

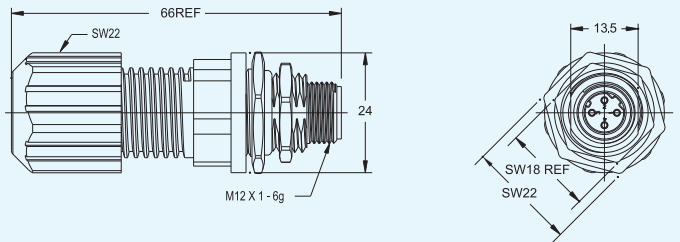

RECEPTACLE RIGHT ANGLE MALE

part number

HDM12RM _RA

1,2,3,4 type contact available

B,D,P, code available

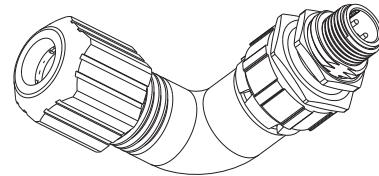

DIMENSIONS (Millimeters)

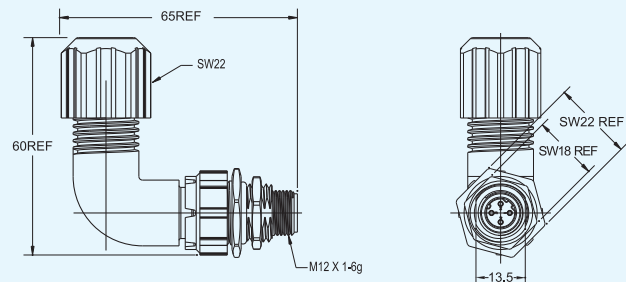

RECEPTACLE STRAIGHT FEMALE

part number

HDM12RF _ST

1,2,3,4 type contact available

B,D,P, code available

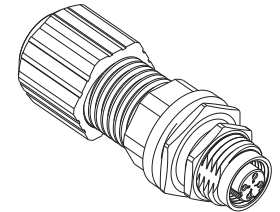

DIMENSIONS (Millimeters)

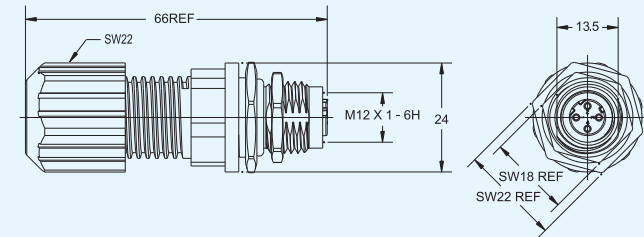

RECEPTACLE RIGHT ANGLE FEMALE

part number

HDM12PF _RA

1,2,3,4 type contact available

B,D,P, code available

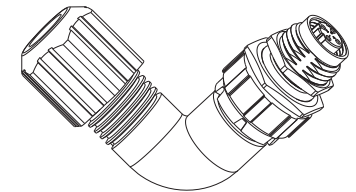

DIMENSIONS (Millimeters)

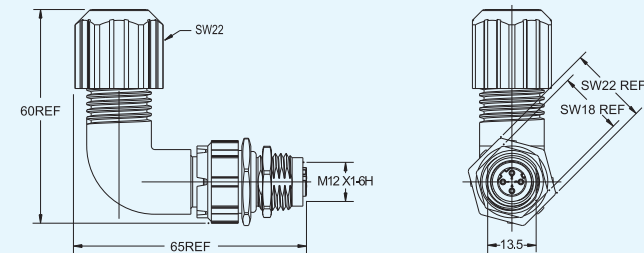

M8 SPECIFICATION

Mechanical Data:

- Durability: 500 Cycles
- Salt Spray: 720Hours different plating and base material
- Sealing Requirement: IP 67/IP68(mated)
- Operating temperature -40°C~+100°C

Standards:

- Connectors: IEC61076-2-101

Electrical:

- Insulation resistance: $\geq 20M$ ohms
- Contact resistance $\leq 5m$ ohms
- Rated current: 4A
- Operating voltage 60V AV/DC

Materials:

- Shell, Screw/Nut: Copper/Al alloy/ Zn alloy with nickel plating
- Contact: copper with gold plating
- Insert material: PA+GF meet UL 94V0
- Sealing: Epoxy resin
- O-ring: NBR/SR

Cable characteristics:

- Material: UL certified PVC or customer requestment
- Cable size: 22AWG-20AWG, 3C, 4C, 5C
- Current rating: 4A
- Voltage rating: 60V AC/DC
- Shielded/unshielded available.
- Heavy-duty application in harsh environments
- Highly resistant against abraion
- Good resistance against oil, lubricants, and coolants.
- Halogen free, hydrolysis and UV resistant.
- Flame retardant

INSERT ARRANGEMENT

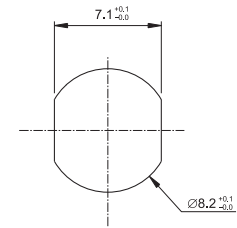
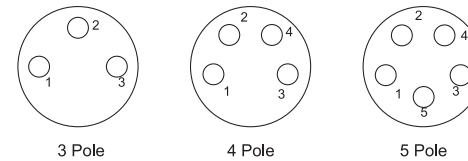

RECOMMENDATION PANELCUT OUT

CJE8 C R ST 04 S W PCG R L Blank

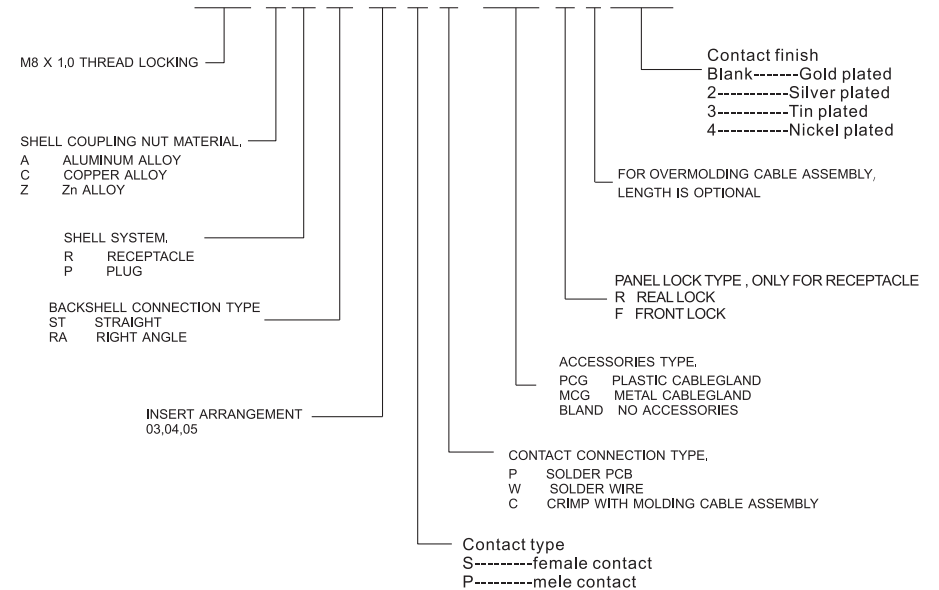

PLUG STRAIGHT MALE CABLE ASSEMBLY

part number

CJE8CPST_PW

- Blank (Gold) ,2,3,4 type contact available
- 3,4,5 position available

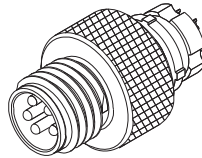

DIMENSIONS (Millimeters)

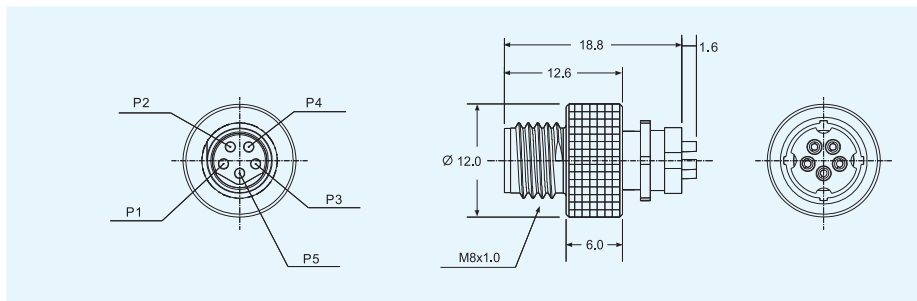

RECEPTACLE REAL LOCK FEMALE SOLDER TYPE

part number

CJE8CRST_SWR

- Blank (Gold) ,2,3,4 type contact available
- 3,4,5 position available

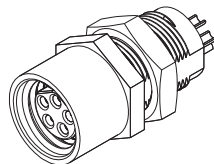

DIMENSIONS (Millimeters)

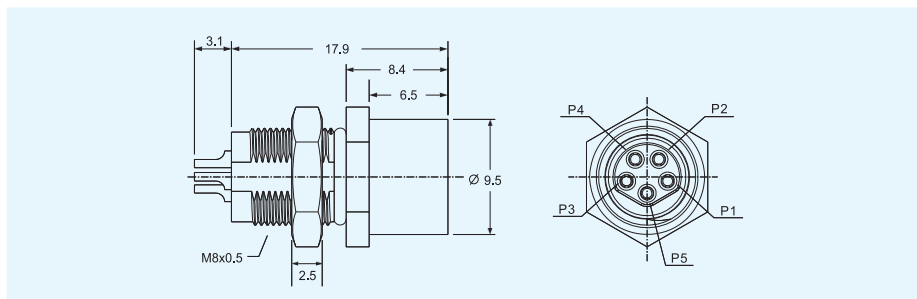

PLUG STRAIGHT MALE OVERMOLDING CABLE ASSEMBLY

part number

CJE8CPST_P L

- Blank (Gold) ,2,3,4 type contact available
- Solder wire(W)/crimp(C)type available
- 3,4,5 position available

DIMENSIONS (Millimeters)

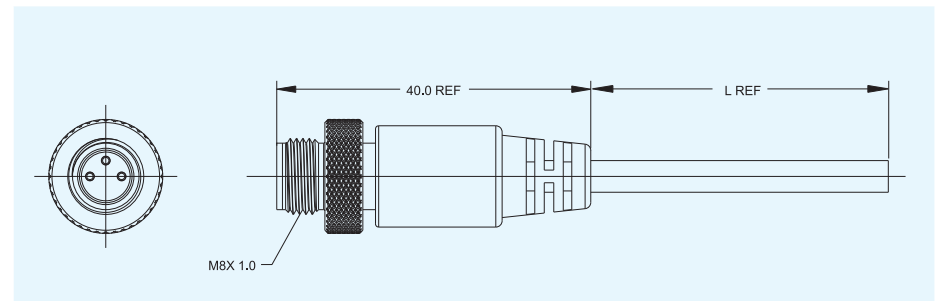

PLUG STRAIGHT FEMALE OVERMOLDING CABLE ASSEMBLY

part number

CJE8CPST_S L

- Blank (Gold) ,2,3,4 type contact available
- Solder wire(W)/crimp(C)type available
- 3,4,5 position available

DIMENSIONS (Millimeters)

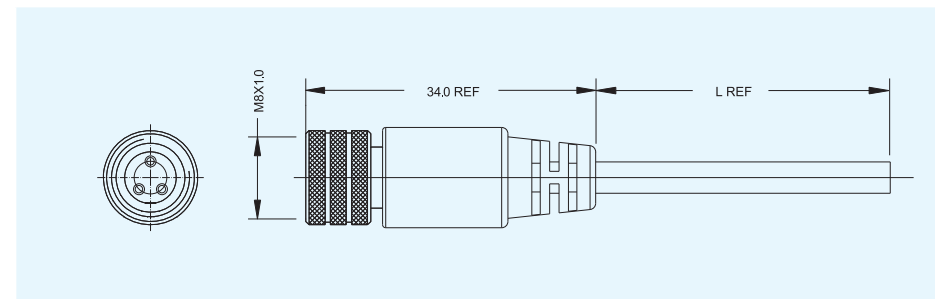

PLUG RIGHT ANGLE MALE OVERMOLDING CABLE ASSEMBLY

part number

CJE8CPRA_P L

- Blank (Gold) ,2,3,4 type contact available
- Solder wire(W)/crimp(C)type available
- 3,4,5 position available

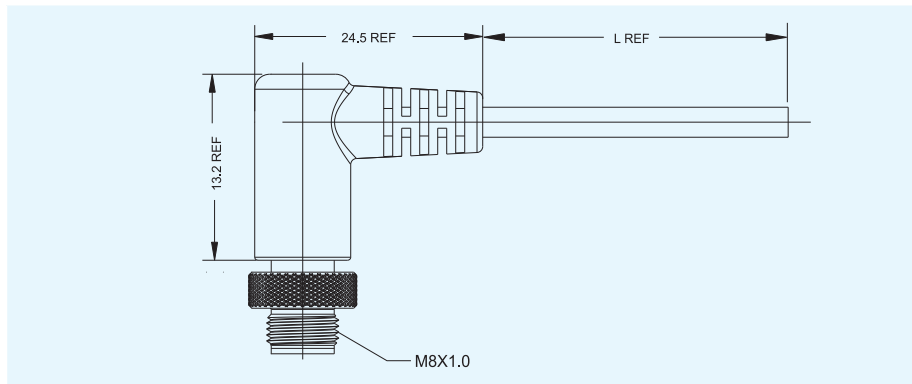

PLUG RIGHT ANGLE FEMALE OVERMOLDING CABLE ASSEMBLY

part number

CJE8CPRA_S L

- Blank (Gold) ,2,3,4 type contact available
- Solder wire(W)/crimp(C)type available
- 3,4,5 position available

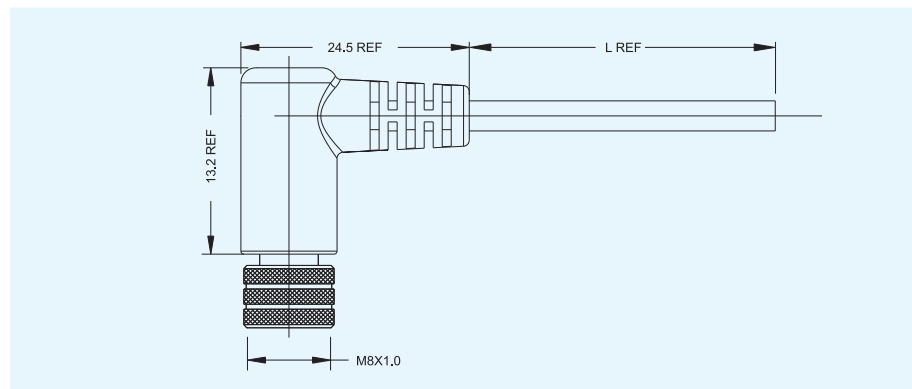

WITH SHIELD CABLE INSTALL INSTRUCTION

- Strip cable jacket about 30mm, fold the cable shield back on the jacket. Trim the insulation about 20mm.



- Strip insulation 5mm, then solder conductor to connector contact cup. Covered the joint with tube.



- Install the adapter to the connector, screw tightly.



- Make the shield between inner ring and outer ring, trim excess shield

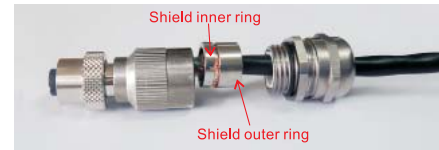

- Push the inner ring and outer ring with shield into the adapter, screw the body and cap of cable gland



WITHOUT SHIELD CABLE INSTALL INSTRUCTION

- Strip cable jacket 30mm.



- Strip insulation 5mm, then solder conductor to connector. Covered the joint with tube.



- Screw the cable gland body and cable gland cap.



Компания «Океан Электроники» предлагает заключение долгосрочных отношений при поставках импортных электронных компонентов на взаимовыгодных условиях!

Наши преимущества:

- Поставка оригинальных импортных электронных компонентов напрямую с производств Америки, Европы и Азии, а так же с крупнейших складов мира;
- Широкая линейка поставок активных и пассивных импортных электронных компонентов (более 30 млн. наименований);
- Поставка сложных, дефицитных, либо снятых с производства позиций;
- Оперативные сроки поставки под заказ (от 5 рабочих дней);
- Экспресс доставка в любую точку России;
- Помощь Конструкторского Отдела и консультации квалифицированных инженеров;
- Техническая поддержка проекта, помощь в подборе аналогов, поставка прототипов;
- Поставка электронных компонентов под контролем ВП;
- Система менеджмента качества сертифицирована по Международному стандарту ISO 9001;
- При необходимости вся продукция военного и аэрокосмического назначения проходит испытания и сертификацию в лаборатории (по согласованию с заказчиком);
- Поставка специализированных компонентов военного и аэрокосмического уровня качества (Xilinx, Altera, Analog Devices, Intersil, Interpoint, Microsemi, Actel, Aeroflex, Peregrine, VPT, Syfer, Eurofarad, Texas Instruments, MS Kennedy, Miteq, Cobham, E2V, MA-COM, Hittite, Mini-Circuits, General Dynamics и др.);

Компания «Океан Электроники» является официальным дистрибьютором и эксклюзивным представителем в России одного из крупнейших производителей разъемов военного и аэрокосмического назначения «**JONHON**», а так же официальным дистрибьютором и эксклюзивным представителем в России производителя высокотехнологичных и надежных решений для передачи СВЧ сигналов «**FORSTAR**».



JONHON

«**JONHON**» (основан в 1970 г.)

Разъемы специального, военного и аэрокосмического назначения:

(Применяются в военной, авиационной, аэрокосмической, морской, железнодорожной, горно- и нефтедобывающей отраслях промышленности)

«**FORSTAR**» (основан в 1998 г.)

ВЧ соединители, коаксиальные кабели,
кабельные сборки и микроволновые компоненты:

(Применяются в телекоммуникациях гражданского и специального назначения, в средствах связи, РЛС, а так же военной, авиационной и аэрокосмической отраслях промышленности).



Телефон: 8 (812) 309-75-97 (многоканальный)

Факс: 8 (812) 320-03-32

Электронная почта: ocean@oceanchips.ru

Web: <http://oceanchips.ru/>

Адрес: 198099, г. Санкт-Петербург, ул. Калинина, д. 2, корп. 4, лит. А