



**SOT89-3  
Voltage Regulator  
Evaluation Board  
User's Guide**

---

**Note the following details of the code protection feature on Microchip devices:**

- Microchip products meet the specification contained in their particular Microchip Data Sheet.
- Microchip believes that its family of products is one of the most secure families of its kind on the market today, when used in the intended manner and under normal conditions.
- There are dishonest and possibly illegal methods used to breach the code protection feature. All of these methods, to our knowledge, require using the Microchip products in a manner outside the operating specifications contained in Microchip's Data Sheets. Most likely, the person doing so is engaged in theft of intellectual property.
- Microchip is willing to work with the customer who is concerned about the integrity of their code.
- Neither Microchip nor any other semiconductor manufacturer can guarantee the security of their code. Code protection does not mean that we are guaranteeing the product as "unbreakable."

Code protection is constantly evolving. We at Microchip are committed to continuously improving the code protection features of our products. Attempts to break Microchip's code protection feature may be a violation of the Digital Millennium Copyright Act. If such acts allow unauthorized access to your software or other copyrighted work, you may have a right to sue for relief under that Act.

---

Information contained in this publication regarding device applications and the like is provided only for your convenience and may be superseded by updates. It is your responsibility to ensure that your application meets with your specifications. MICROCHIP MAKES NO REPRESENTATIONS OR WARRANTIES OF ANY KIND WHETHER EXPRESS OR IMPLIED, WRITTEN OR ORAL, STATUTORY OR OTHERWISE, RELATED TO THE INFORMATION, INCLUDING BUT NOT LIMITED TO ITS CONDITION, QUALITY, PERFORMANCE, MERCHANTABILITY OR FITNESS FOR PURPOSE. Microchip disclaims all liability arising from this information and its use. Use of Microchip devices in life support and/or safety applications is entirely at the buyer's risk, and the buyer agrees to defend, indemnify and hold harmless Microchip from any and all damages, claims, suits, or expenses resulting from such use. No licenses are conveyed, implicitly or otherwise, under any Microchip intellectual property rights.

**Trademarks**

The Microchip name and logo, the Microchip logo, Accuron, dsPIC, KEELOQ, KEELOQ logo, MPLAB, PIC, PICmicro, PICSTART, rfPIC, SmartShunt and UNI/O are registered trademarks of Microchip Technology Incorporated in the U.S.A. and other countries.

FilterLab, Linear Active Thermistor, MXDEV, MXLAB, SEEVAL, SmartSensor and The Embedded Control Solutions Company are registered trademarks of Microchip Technology Incorporated in the U.S.A.

Analog-for-the-Digital Age, Application Maestro, CodeGuard, dsPICDEM, dsPICDEM.net, dsPICworks, dsSPEAK, ECAN, ECONOMONITOR, FanSense, In-Circuit Serial Programming, ICSP, ICEPIC, Mindi, MiWi, MPASM, MPLAB Certified logo, MPLIB, MPLINK, mTouch, PICkit, PICDEM, PICDEM.net, PICTail, PIC<sup>32</sup> logo, PowerCal, PowerInfo, PowerMate, PowerTool, REAL ICE, rfLAB, Select Mode, Total Endurance, WiperLock and ZENA are trademarks of Microchip Technology Incorporated in the U.S.A. and other countries.

SQTP is a service mark of Microchip Technology Incorporated in the U.S.A.

All other trademarks mentioned herein are property of their respective companies.

© 2009, Microchip Technology Incorporated, Printed in the U.S.A., All Rights Reserved.

 Printed on recycled paper.

**QUALITY MANAGEMENT SYSTEM**  
**CERTIFIED BY DNV**  
**== ISO/TS 16949:2002 ==**

*Microchip received ISO/TS-16949:2002 certification for its worldwide headquarters, design and wafer fabrication facilities in Chandler and Tempe, Arizona; Gresham, Oregon and design centers in California and India. The Company's quality system processes and procedures are for its PIC<sup>®</sup> MCUs and dsPIC<sup>®</sup> DSCs, KEELOQ<sup>®</sup> code hopping devices, Serial EEPROMs, microperipherals, nonvolatile memory and analog products. In addition, Microchip's quality system for the design and manufacture of development systems is ISO 9001:2000 certified.*



# SOT89-3 VOLTAGE REGULATOR EVALUATION BOARD USER'S GUIDE

---

---

## Table of Contents

---

---

<b>Preface</b> .....	<b>1</b>
Introduction.....	1
Document Layout .....	1
Conventions Used in this Guide .....	2
Recommended Reading.....	3
The Microchip Web Site .....	3
Customer Support .....	3
Document Revision History .....	3
<b>Chapter 1. Product Overview</b>	
1.1 Introduction .....	5
1.2 What is the SOT89-3 Voltage Regulator Evaluation Board? .....	5
1.3 What the SOT89-3 Voltage Regulator Evaluation Board kit includes .....	6
<b>Chapter 2. Installation and Operation</b>	
2.1 Introduction .....	7
2.2 Features .....	7
2.3 Getting Started .....	7
<b>Appendix A. Schematic and Layouts</b>	
A.1 Introduction .....	11
A.2 Board – Schematic .....	12
A.3 Board – Top Silk .....	13
A.4 Board – Top Solder .....	14
A.5 Board – Bottom Solder .....	15
<b>Appendix B. Bill Of Materials (BOM)</b>	
<b>Worldwide Sales and Service</b> .....	<b>18</b>

# SOT89-3 Voltage Regulator Evaluation Board User's Guide

---

---

NOTES:



# SOT89-3 VOLTAGE REGULATOR EVALUATION BOARD USER'S GUIDE

## Preface

### NOTICE TO CUSTOMERS

All documentation becomes dated, and this manual is no exception. Microchip tools and documentation are constantly evolving to meet customer needs, so some actual dialogs and/or tool descriptions may differ from those in this document. Please refer to our web site ([www.microchip.com](http://www.microchip.com)) to obtain the latest documentation available.

Documents are identified with a "DS" number. This number is located on the bottom of each page, in front of the page number. The numbering convention for the DS number is "DSXXXXA", where "XXXX" is the document number and "A" is the revision level of the document.

For the most up-to-date information on development tools, see the MPLAB® IDE on-line help. Select the Help menu, and then Topics to open a list of available on-line help files.

## INTRODUCTION

This chapter contains general information that will be useful to know before using the SOT89-3 Voltage Regulator Evaluation Board. Items discussed in this chapter include:

- Document Layout
- Conventions Used in this Guide
- Recommended Reading
- The Microchip Web Site
- Customer Support
- Document Revision History

## DOCUMENT LAYOUT

This document describes how to use the SOT89-3 Voltage Regulator Evaluation Board. The manual layout is as follows:

- **Chapter 1. "Product Overview"** – Important information about the SOT89-3 Voltage Regulator Evaluation Board.
- **Chapter 2. "Installation and Operation"** – Includes instructions on how to get started with this user's guide and a description of the user's guide.
- **Appendix A. "Schematic and Layouts"** – Shows the schematic and layout diagrams for the SOT89-3 Voltage Regulator Evaluation Board.
- **Appendix B. "Bill Of Materials (BOM)"** – Lists the parts used to build the SOT89-3 Voltage Regulator Evaluation Board.

# SOT89-3 Voltage Regulator Evaluation Board User's Guide

---

## CONVENTIONS USED IN THIS GUIDE

This manual uses the following documentation conventions:

### DOCUMENTATION CONVENTIONS

Description	Represents	Examples
<b>Arial font:</b>		
Italic characters	Referenced books	<i>MPLAB<sup>®</sup> IDE User's Guide</i>
	Emphasized text	...is the <i>only</i> compiler...
Initial caps	A window	the Output window
	A dialog	the Settings dialog
	A menu selection	select Enable Programmer
Quotes	A field name in a window or dialog	"Save project before build"
Underlined, italic text with right angle bracket	A menu path	<u><i>File&gt;Save</i></u>
Bold characters	A dialog button	Click <b>OK</b>
	A tab	Click the <b>Power</b> tab
N'Rnnnn	A number in verilog format, where N is the total number of digits, R is the radix and n is a digit.	4'b0010, 2'hF1
Text in angle brackets < >	A key on the keyboard	Press <Enter>, <F1>
<b>Courier New font:</b>		
Plain Courier New	Sample source code	#define START
	Filenames	autoexec.bat
	File paths	c:\mcc18\h
	Keywords	_asm, _endasm, static
	Command-line options	-Opa+, -Opa-
	Bit values	0, 1
	Constants	0xFF, 'A'
Italic Courier New	A variable argument	<i>file.o</i> , where <i>file</i> can be any valid filename
Square brackets [ ]	Optional arguments	mcc18 [options] <i>file</i> [options]
Curly brackets and pipe character: {   }	Choice of mutually exclusive arguments; an OR selection	errorlevel {0 1}
Ellipses...	Replaces repeated text	var_name [, var_name...]
	Represents code supplied by user	void main (void) { ... }

## RECOMMENDED READING

This user's guide describes how to use SOT89-3 Voltage Regulator Evaluation Board. Other useful documents are listed below. The following Microchip documents are available and recommended as supplemental reference resources.

**MCP1700A Datasheet, “Low Quiescent Current LDO”, DS22069**

**MCP1701A Datasheet, “2  $\mu$ A Low-Dropout Positive Voltage Regulator”, DS21991**

**MCP1702 Datasheet, “250 mA Low Quiescent Current LDO Regulator”, DS22008**

**MCP1703 Datasheet, “250 mA, 16V, Low Quiescent Current LDO Regulator”, DS22049**

These datasheets provide useful information regarding voltage regulator parameters that may be validated using this evaluation board.

## THE MICROCHIP WEB SITE

Microchip provides online support via our web site at [www.microchip.com](http://www.microchip.com). This web site is used as a means to make files and information easily available to customers. Accessible by using your favorite Internet browser, the web site contains the following information:

- **Product Support** – Data sheets and errata, application notes and sample programs, design resources, user's guides and hardware support documents, latest software releases and archived software
- **General Technical Support** – Frequently Asked Questions (FAQs), technical support requests, online discussion groups, Microchip consultant program member listing
- **Business of Microchip** – Product selector and ordering guides, latest Microchip press releases, listing of seminars and events, listings of Microchip sales offices, distributors and factory representatives

## CUSTOMER SUPPORT

Users of Microchip products can receive assistance through several channels:

- Distributor or Representative
- Local Sales Office
- Field Application Engineer (FAE)
- Technical Support
- Development Systems Information Line

Customers should contact their distributor, representative or field application engineer (FAE) for support. Local sales offices are also available to help customers. A listing of sales offices and locations is included in the back of this document.

Technical support is available through the web site at: <http://support.microchip.com>.

## DOCUMENT REVISION HISTORY

### Revision A (February 2009)

- Initial Release of this Document.

# SOT89-3 Voltage Regulator Evaluation Board User's Guide

---

---

NOTES:





# SOT89-3 VOLTAGE REGULATOR EVALUATION BOARD USER'S GUIDE

## Chapter 1. Product Overview

### 1.1 INTRODUCTION

The SOT89-3 Voltage Regulator Evaluation Board is designed to provide functional evaluation of Microchip Voltage Regulators that utilize the SOT89-3 package and the following device pinouts:

Pin No.	U2 footprint	U1 footprint
Pin 1	VIN	GND
Pin 2	GND	VIN
Pin 3	VOUT	VOUT

The SOT89-3 Voltage Regulator Evaluation Board does not come with a voltage regulator soldered onto the board. This allows the user to attach the voltage regulator of their choosing to the board and perform quiescent current, ground current, PSRR, and other desired tests.

The SOT89-3 Voltage Regulator Evaluation Board is based upon a modular concept which will allow the user to plug in additional boards to increase the test capability of the voltage regulator. Planned additional modular plug-in boards currently consist of an Input Voltage Linestep Board, Output Voltage Loadstep Board, and several other device packages.

### 1.2 WHAT IS THE SOT89-3 VOLTAGE REGULATOR EVALUATION BOARD?

The SOT89-3 Voltage Regulator Evaluation Board is designed to evaluate and test voltage regulators. By soldering the desired device to the evaluation board, the user can easily validate several parameters of the device.

#### 1.2.1 Functional Blocks

The SOT89-3 Voltage Regulator Evaluation Board can be broken up into 3 functional blocks. The blocks are:

- Input Capacitance
- Ground Current Measurement
- Load Resistor

#### 1.2.2 Input Capacitance

Jumper JP1 connects the input capacitance to the circuit. The input capacitor is disconnected when performing Power Supply Ripple Rejection tests. By default, C1 is populated with a 1  $\mu$ F, 50V, XR7 ceramic capacitor.

#### 1.2.3 Ground Current Measurement

Jumper JP3 allows measurement of ground current. When a current meter is connected to TP6 and TP7 and jumper JP3 is removed, the ground current of the device may be measured.

## 1.2.4 Load Resistor

R5 may be populated with the desired load resistor value for the device being evaluated. JP4 connects R5 to the device output.

## 1.2.5 Output Capacitor

C2 may be populated with the desired surface mount output capacitance. By default, C2 is populated with a 1  $\mu$ F, 6.3V, XR7 ceramic capacitor.

## 1.2.6 Power Supply

J1 or TP1 and TP2 are connected to the user's power supply.

## 1.2.7 Device Selection

JP2 and JP5 select either device U1 or device U2. Placing the jumper on pins 1-2 of JP2 and JP5 selects the device at U2. Placing the jumper on pins 2-3 of JP2 and JP5 selects the device at U1.

## 1.3 WHAT THE SOT89-3 VOLTAGE REGULATOR EVALUATION BOARD KIT INCLUDES

This SOT89-3 Voltage Regulator Evaluation Board kit includes:

- SOT89-3 Voltage Regulator Evaluation Board, 102-00213, (Qty 2)
- Microchip Analog and Interface Products Demonstration Boards CD-ROM  
Includes: (DS21912)
  - SOT89-3 Voltage Regulator Evaluation Board User's Guide, DS51796



# SOT89-3 VOLTAGE REGULATOR EVALUATION BOARD USER'S GUIDE

## Chapter 2. Installation and Operation

### 2.1 INTRODUCTION

The SOT89-3 Voltage Regulator Evaluation Board is designed to be used to facilitate evaluation of Microchip's voltage regulators or to be used as a standalone voltage regulator board. Jumpers have been placed on the board to facilitate testing of specific voltage regulator parameters.

The SOT89-3 Voltage Regulator Evaluation Board kit comes with a 1  $\mu$ F ceramic input and output capacitor soldered to the board. The board has one unpopulated resistor location that may be used for a load.

### 2.2 FEATURES

The SOT89-3 Voltage Regulator Evaluation Board has the following features:

- Input and Output headers for future connection to Line Step and Load Step modules
- Ample testpoints to attach multimeters, power supplies, and loads.
- Jumper to select ground current measurement
- Jumper to connect output load resistor
- Jumper to connect input capacitor to circuit
- Jumper to select one of two device pinouts

### 2.3 GETTING STARTED

The SOT89-3 Voltage Regulator Evaluation Board is fully assembled and tested. All that is required for operating is a user supplied voltage regulator and a supply voltage source. Some of the tests that may be completed using the SOT89-3 Voltage Regulator Evaluation Board shall now be described.

#### 2.3.1 Device Pinout Selection (For All Tests)

For all tests, JP2 and JP5 must be set to select the desired device and footprint.

Jumpers	U1 Footprint	U2 Footprint
JP2 - connect pins	2-3	1-2
JP5 - connect pins	2-3	1-2

## 2.3.2 Ground Current and Quiescent Current

When measuring ground current, jumper JP3 should be removed, otherwise leave jumper JP3 on. To measure ground current, perform the following steps:

1. Add desired load resistor to R5.
2. Remove jumpers JP3 and JP4.
3. Connect an ampere meter across testpoints TP6(+) and TP7(-). Select the appropriate meter scale for the device being evaluated.
4. Connect a voltmeter across testpoints TP9(+) and TP10(-).
5. Add jumper JP1.
6. Apply source voltage to testpoints TP1(+) and TP2(-).
7. Verify the voltage across testpoints TP6 and TP7 is within the expected range of the device being tested.
8. Read the Ground Current directly from the ampere meter connected to testpoints TP6 and TP7.
9. Vary the input voltage to obtain data for ground current versus input voltage. With no load attached to the output of the voltage regulator, the measured **ground current** is also called the **quiescent current** of the regulator.
10. Add the load selection jumper, JP4.
11. Read the Ground Current directly from the ampere meter connected to testpoints TP6 and TP7.
12. The data collected will be the **ground current** versus load current.

## 2.3.3 Load Resistance

R5 is used to set the desired load value. One choice is to set R5 to the minimum current desired for testing.

## 2.3.4 Line Step

Dynamic Line Step response may be evaluated by connecting an electronically switched input voltage to testpoints TP1(+) and TP2(-) or to connector J1. An oscilloscope is connected to TP3(Ch1 Trigger), TP9(Ch2) and TP10(Gnd). An appropriate load is selected using R5 and JP4. The input voltage is then electronically switched from a low voltage to a high voltage. The corresponding voltage waveform data of the voltage regulator response is captured by the oscilloscope. Microchip will be offering a Line Step module, Part #: 102-00196, that connects directly to connector J1. The Line Step module will be capable of switching between two voltage levels that the user supplies.

## 2.3.5 Load Step

Dynamic Load Step response may be evaluated by connecting an electronically switched load to testpoints TP9(+) and TP10(-) or to connector P1. An oscilloscope is connected to the electronic load switch signal (Ch1 Trigger) and to TP9(Ch2) and TP10(Gnd). The load is then electronically switched from a high resistance to a low resistance. The corresponding voltage waveform data of the voltage regulator response is captured by the oscilloscope. Microchip will be offering a Load Step module, Part #: 102-00197, that connects directly to connector P1. The Load Step module will have several selectable load values populated onboard to cover a wide range of loads. The load will have the ability to be electronically or manually switched.

## 2.3.6 Power Supply Rejection Ratio (PSRR)

Power Supply Rejection Ratio tests are performed by removing the input capacitor jumper, JP1, and connecting an appropriate PSRR analyzer to the SOT89-3 Voltage Regulator Evaluation Board. The PSRR analyzer may then sweep the input voltage frequencies and record the corresponding output voltages.

# SOT89-3 Voltage Regulator Evaluation Board User's Guide

---

---

NOTES:



# SOT89-3 VOLTAGE REGULATOR EVALUATION BOARD USER'S GUIDE

---

---

## Appendix A. Schematic and Layouts

---

---

### A.1 INTRODUCTION

This appendix contains the following schematic and layouts for the SOT89-3 Voltage Regulator Evaluation Board:

- Board - Schematic
- Board - Top Silk-Screen
- Board - Top Layer
- Board - Bottom Layer

# SOT89-3 Voltage Regulator Evaluation Board User's Guide

## A.2 BOARD – SCHEMATIC

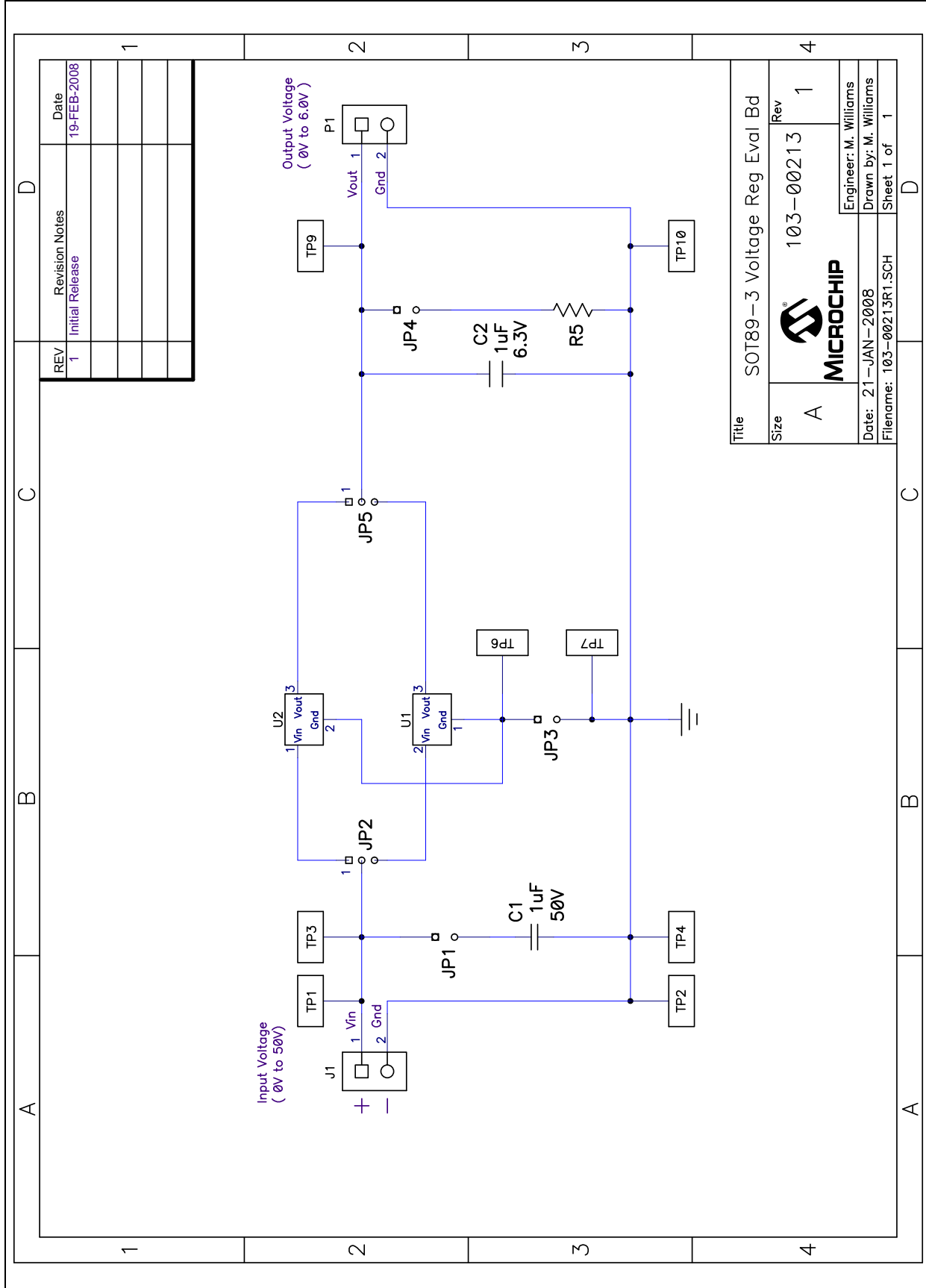



## A.3 BOARD – TOP SILK-SCREEN

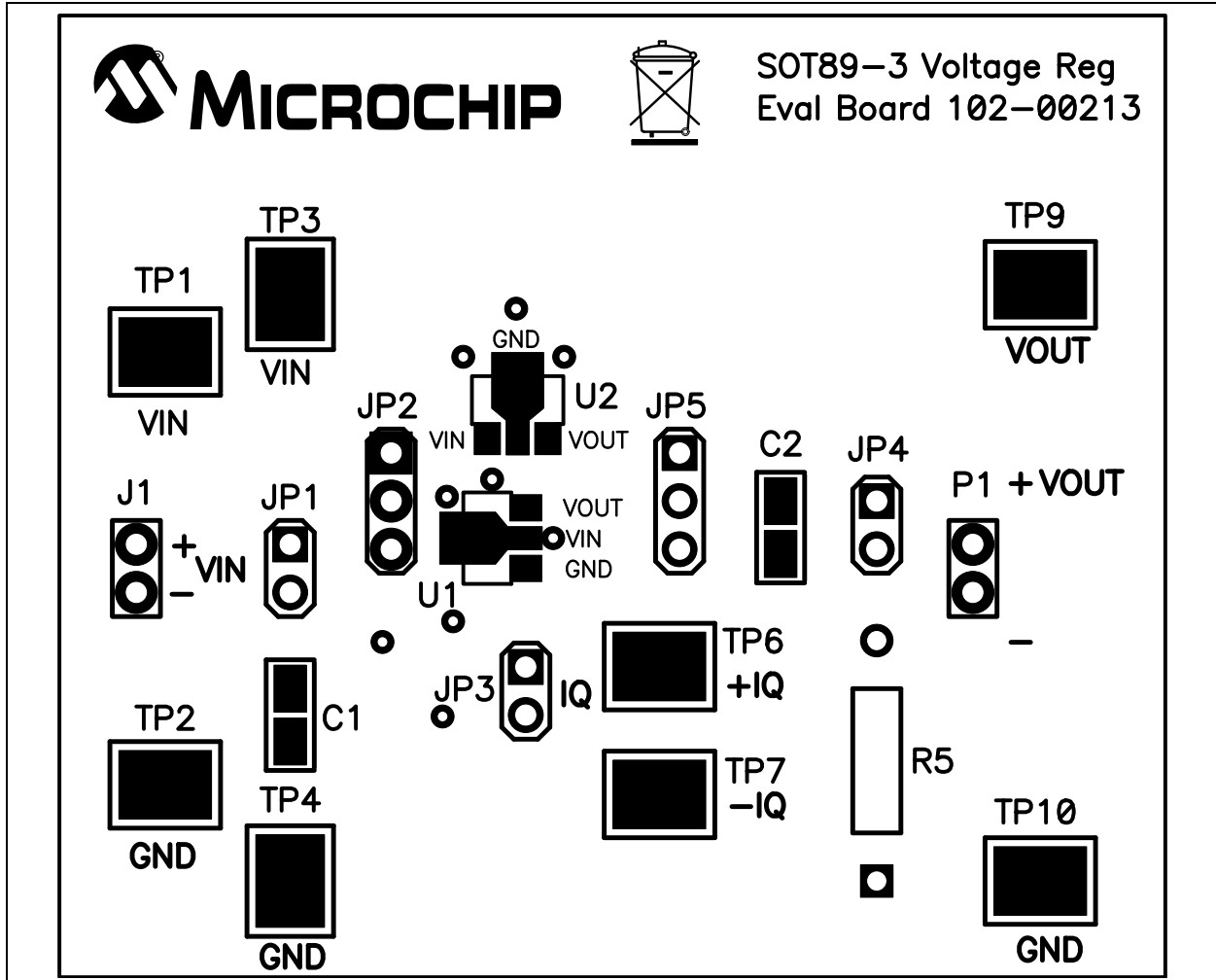

## A.4 BOARD – TOP LAYER

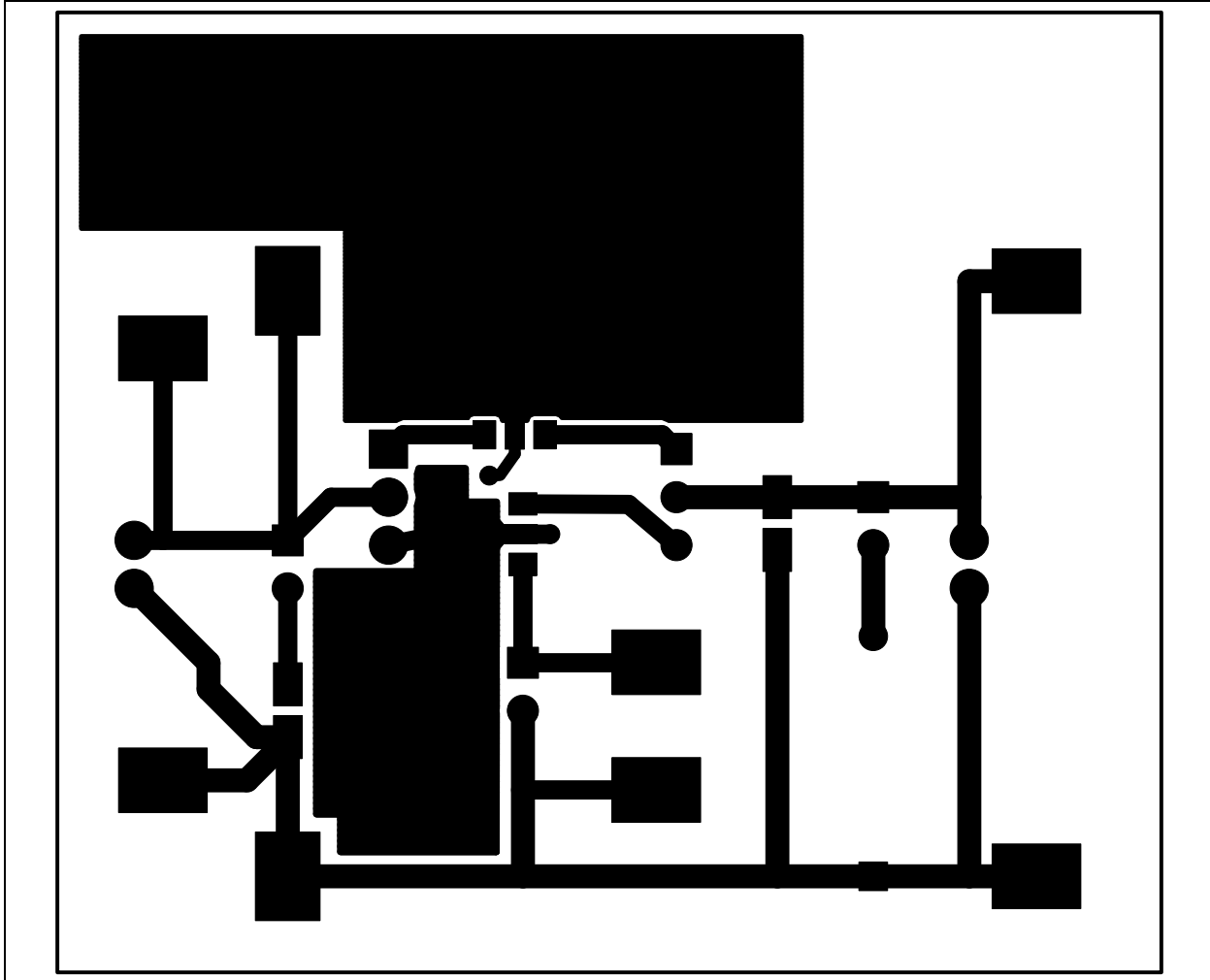

## A.5 BOARD – BOTTOM LAYER

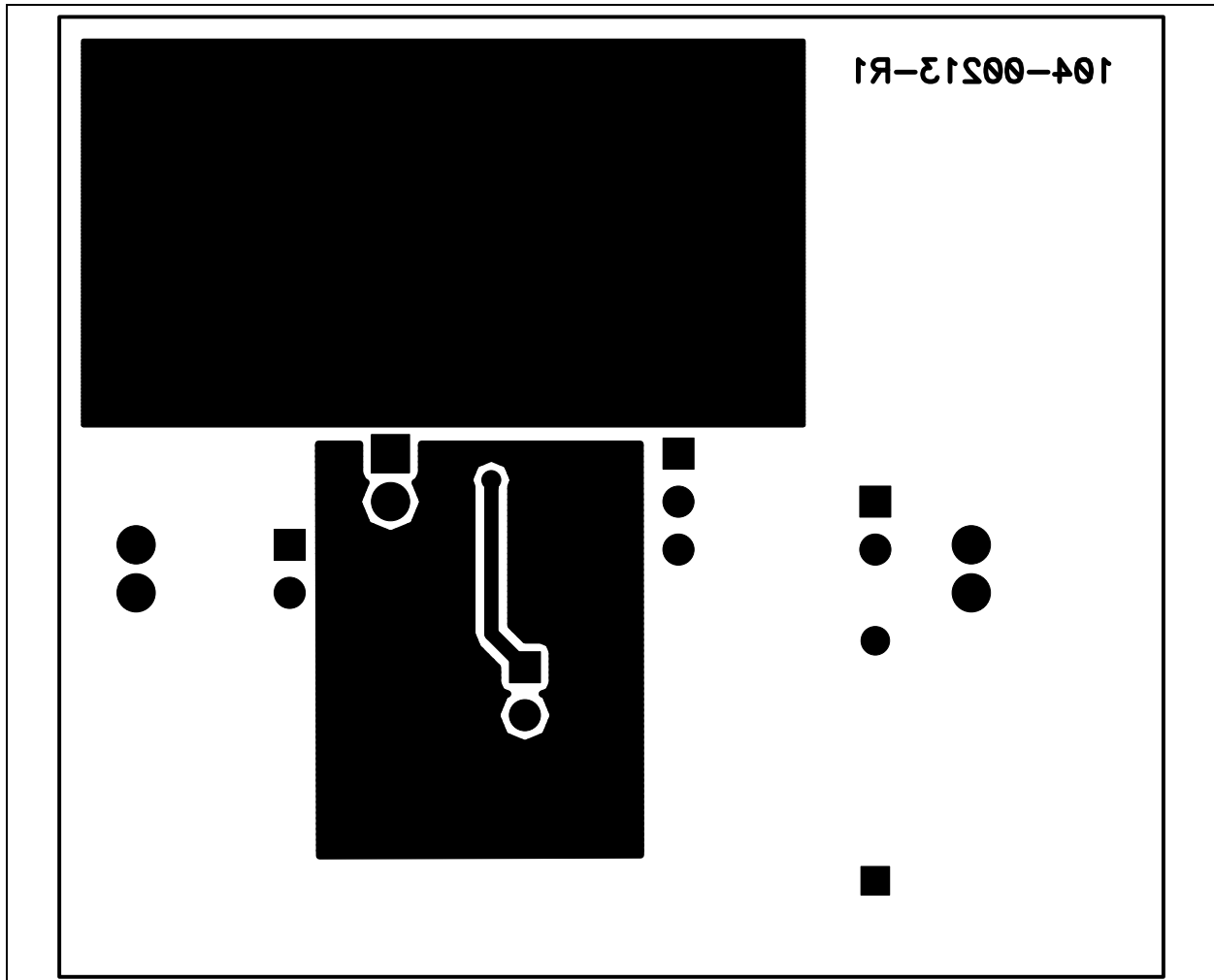

# SOT89-3 Voltage Regulator Evaluation Board User's Guide

---

---

NOTES:



# SOT89-3 VOLTAGE REGULATOR EVALUATION BOARD USER'S GUIDE

## Appendix B. Bill Of Materials (BOM)

**TABLE B-1: BILL OF MATERIALS (BOM)**

Qty	Reference	Description	Manufacturer	Part Number
1	C1	CAP CERAMIC 1.0 $\mu$ F 50V X7R 0805	Murata Electronics®	GRM21BR71H105KA12L
1	C2	CAP CERAMIC 1.0 $\mu$ F 16V X7R 0805	Kemet® Electronics Corp	C0805C105K4RACTU
*0.06	J1	2 pin RA header, 0.100 centers, 0.025 sq pins, 0.070 pcb to pin center height,  * 36 pins to a strip (yields 18 headers)	3M	929835-01-36-RK
*0.17	JP1, JP3, JP4	2 pin header, 0.100 centers, 0.025 sq pins, 0.070 pcb to pin center height,  * 36 pins to a strip (yields 18 headers)	Molex® Electronics	22-28-4360
5	JP1<< >>JP5	Connector, Jumper Shorting, Tin	Sullins Electronics	STC02SYAN
*0.17	JP2, JP5	3 pin header, 0.100 centers, 0.025 sq pins, 0.070 pcb to pin center height,  * 36 pins to a strip (yields 12 headers)	Molex Electronics	22-28-4360
4	On Each Corner	Bumpon Hemisphere, 0.44 x 0.20, Black	3M	SJ-5003 (BLACK)
1	P1	RA socket, 0.100 centers, 0.025 sq pins, 0.070 pcb to pin center height	Sullins Electronics	PPPC021LGBN-RC
1	PCB	RoHS Compliant Bare PCB, SOT89-3 Voltage Regulator Evaluation Board (250 boards, 4week delivery)	Advanced Circuits	104-000213
1	R5	DO NOT POPULATE	—	—
10	TP1, TP2, TP3, TP4, TP6, TP7, TP9, TP10	SMT Testpoint	Keystone Electronics®	5016
2	U1, U2	DO NOT POPULATE	—	—

**Note:** The components listed in this Bill of Materials are representative of the PCB assembly. The released BOM used in manufacturing uses all RoHS-compliant components.



---

---

## Worldwide Sales and Service

---

---

### AMERICAS

**Corporate Office**  
2355 West Chandler Blvd.  
Chandler, AZ 85224-6199  
Tel: 480-792-7200  
Fax: 480-792-7277  
Technical Support:  
<http://support.microchip.com>  
Web Address:  
[www.microchip.com](http://www.microchip.com)

**Atlanta**  
Duluth, GA  
Tel: 678-957-9614  
Fax: 678-957-1455

**Boston**  
Westborough, MA  
Tel: 774-760-0087  
Fax: 774-760-0088

**Chicago**  
Itasca, IL  
Tel: 630-285-0071  
Fax: 630-285-0075

**Cleveland**  
Independence, OH  
Tel: 216-447-0464  
Fax: 216-447-0643

**Dallas**  
Addison, TX  
Tel: 972-818-7423  
Fax: 972-818-2924

**Detroit**  
Farmington Hills, MI  
Tel: 248-538-2250  
Fax: 248-538-2260

**Kokomo**  
Kokomo, IN  
Tel: 765-864-8360  
Fax: 765-864-8387

**Los Angeles**  
Mission Viejo, CA  
Tel: 949-462-9523  
Fax: 949-462-9608

**Santa Clara**  
Santa Clara, CA  
Tel: 408-961-6444  
Fax: 408-961-6445

**Toronto**  
Mississauga, Ontario,  
Canada  
Tel: 905-673-0699  
Fax: 905-673-6509

### ASIA/PACIFIC

**Asia Pacific Office**  
Suites 3707-14, 37th Floor  
Tower 6, The Gateway  
Harbour City, Kowloon  
Hong Kong  
Tel: 852-2401-1200  
Fax: 852-2401-3431

**Australia - Sydney**  
Tel: 61-2-9868-6733  
Fax: 61-2-9868-6755

**China - Beijing**  
Tel: 86-10-8528-2100  
Fax: 86-10-8528-2104

**China - Chengdu**  
Tel: 86-28-8665-5511  
Fax: 86-28-8665-7889

**China - Hong Kong SAR**  
Tel: 852-2401-1200  
Fax: 852-2401-3431

**China - Nanjing**  
Tel: 86-25-8473-2460  
Fax: 86-25-8473-2470

**China - Qingdao**  
Tel: 86-532-8502-7355  
Fax: 86-532-8502-7205

**China - Shanghai**  
Tel: 86-21-5407-5533  
Fax: 86-21-5407-5066

**China - Shenyang**  
Tel: 86-24-2334-2829  
Fax: 86-24-2334-2393

**China - Shenzhen**  
Tel: 86-755-8203-2660  
Fax: 86-755-8203-1760

**China - Wuhan**  
Tel: 86-27-5980-5300  
Fax: 86-27-5980-5118

**China - Xiamen**  
Tel: 86-592-2388138  
Fax: 86-592-2388130

**China - Xian**  
Tel: 86-29-8833-7252  
Fax: 86-29-8833-7256

**China - Zhuhai**  
Tel: 86-756-3210040  
Fax: 86-756-3210049

### ASIA/PACIFIC

**India - Bangalore**  
Tel: 91-80-3090-4444  
Fax: 91-80-3090-4080

**India - New Delhi**  
Tel: 91-11-4160-8631  
Fax: 91-11-4160-8632

**India - Pune**  
Tel: 91-20-2566-1512  
Fax: 91-20-2566-1513

**Japan - Yokohama**  
Tel: 81-45-471- 6166  
Fax: 81-45-471-6122

**Korea - Daegu**  
Tel: 82-53-744-4301  
Fax: 82-53-744-4302

**Korea - Seoul**  
Tel: 82-2-554-7200  
Fax: 82-2-558-5932 or  
82-2-558-5934

**Malaysia - Kuala Lumpur**  
Tel: 60-3-6201-9857  
Fax: 60-3-6201-9859

**Malaysia - Penang**  
Tel: 60-4-227-8870  
Fax: 60-4-227-4068

**Philippines - Manila**  
Tel: 63-2-634-9065  
Fax: 63-2-634-9069

**Singapore**  
Tel: 65-6334-8870  
Fax: 65-6334-8850

**Taiwan - Hsin Chu**  
Tel: 886-3-572-9526  
Fax: 886-3-572-6459

**Taiwan - Kaohsiung**  
Tel: 886-7-536-4818  
Fax: 886-7-536-4803

**Taiwan - Taipei**  
Tel: 886-2-2500-6610  
Fax: 886-2-2508-0102

**Thailand - Bangkok**  
Tel: 66-2-694-1351  
Fax: 66-2-694-1350

### EUROPE

**Austria - Wels**  
Tel: 43-7242-2244-39  
Fax: 43-7242-2244-393

**Denmark - Copenhagen**  
Tel: 45-4450-2828  
Fax: 45-4485-2829

**France - Paris**  
Tel: 33-1-69-53-63-20  
Fax: 33-1-69-30-90-79

**Germany - Munich**  
Tel: 49-89-627-144-0  
Fax: 49-89-627-144-44

**Italy - Milan**  
Tel: 39-0331-742611  
Fax: 39-0331-466781

**Netherlands - Drunen**  
Tel: 31-416-690399  
Fax: 31-416-690340

**Spain - Madrid**  
Tel: 34-91-708-08-90  
Fax: 34-91-708-08-91

**UK - Wokingham**  
Tel: 44-118-921-5869  
Fax: 44-118-921-5820

# Mouser Electronics

Authorized Distributor

Click to View Pricing, Inventory, Delivery & Lifecycle Information:

[Microchip:](#)

[SOT89-3EV-VREG](#)

Компания «Океан Электроники» предлагает заключение долгосрочных отношений при поставках импортных электронных компонентов на взаимовыгодных условиях!

Наши преимущества:

- Поставка оригинальных импортных электронных компонентов напрямую с производств Америки, Европы и Азии, а так же с крупнейших складов мира;
- Широкая линейка поставок активных и пассивных импортных электронных компонентов (более 30 млн. наименований);
- Поставка сложных, дефицитных, либо снятых с производства позиций;
- Оперативные сроки поставки под заказ (от 5 рабочих дней);
- Экспресс доставка в любую точку России;
- Помощь Конструкторского Отдела и консультации квалифицированных инженеров;
- Техническая поддержка проекта, помощь в подборе аналогов, поставка прототипов;
- Поставка электронных компонентов под контролем ВП;
- Система менеджмента качества сертифицирована по Международному стандарту ISO 9001;
- При необходимости вся продукция военного и аэрокосмического назначения проходит испытания и сертификацию в лаборатории (по согласованию с заказчиком);
- Поставка специализированных компонентов военного и аэрокосмического уровня качества (Xilinx, Altera, Analog Devices, Intersil, Interpoint, Microsemi, Actel, Aeroflex, Peregrine, VPT, Syfer, Eurofarad, Texas Instruments, MS Kennedy, Miteq, Cobham, E2V, MA-COM, Hittite, Mini-Circuits, General Dynamics и др.);

Компания «Океан Электроники» является официальным дистрибьютором и эксклюзивным представителем в России одного из крупнейших производителей разъемов военного и аэрокосмического назначения «JONHON», а так же официальным дистрибьютором и эксклюзивным представителем в России производителя высокотехнологичных и надежных решений для передачи СВЧ сигналов «FORSTAR».



## JONHON

«JONHON» (основан в 1970 г.)

Разъемы специального, военного и аэрокосмического назначения:

(Применяются в военной, авиационной, аэрокосмической, морской, железнодорожной, горно- и нефтедобывающей отраслях промышленности)

«FORSTAR» (основан в 1998 г.)

ВЧ соединители, коаксиальные кабели, кабельные сборки и микроволновые компоненты:

(Применяются в телекоммуникациях гражданского и специального назначения, в средствах связи, РЛС, а так же военной, авиационной и аэрокосмической отраслях промышленности).



Телефон: 8 (812) 309-75-97 (многоканальный)

Факс: 8 (812) 320-03-32

Электронная почта: [ocean@oceanchips.ru](mailto:ocean@oceanchips.ru)

Web: <http://oceanchips.ru/>

Адрес: 198099, г. Санкт-Петербург, ул. Калинина, д. 2, корп. 4, лит. А