



Single/Dual/Quad, +1.8V/10 μ A, SOT23, Beyond-the-Rails Op Amps

MAX4240-MAX4244

General Description

The MAX4240–MAX4244 family of micropower op amps operate from a single +1.8V to +5.5V supply or dual $\pm 0.9V$ to $\pm 2.75V$ supplies and have Beyond-the-Rails™ inputs and rail-to-rail output capabilities. These amplifiers provide a 90kHz gain-bandwidth product while using only 10 μ A of supply current per amplifier. The MAX4241/MAX4243 have a low-power shutdown mode that reduces supply current to less than 1 μ A and forces the output into a high-impedance state. Although the minimum operating voltage is specified at +1.8V, these devices typically operate down to +1.5V. The combination of ultra-low-voltage operation, beyond-the-rails inputs, rail-to-rail outputs, and ultra-low power consumption makes these devices ideal for any portable/two-cell battery-powered system.

These amplifiers have an input common-mode range that extends 200mV beyond each rail, and their outputs typically swing to within 9mV of the rails with a 100k Ω load. Beyond-the-rails input and rail-to-rail output characteristics allow the full power-supply voltage to be used for signal range. The combination of low input offset voltage, low input bias current, and high open-loop gain makes them suitable for low-power/low-voltage precision applications.

The MAX4240 is offered in a space-saving 5-pin SOT23 package. All specifications are guaranteed over the -40°C to +85°C extended temperature range.

Applications

Two-Cell Battery-Powered Systems	Strain Gauges
Portable/Battery-Powered Electronic Equipment	Sensor Amplifiers
Digital Scales	Cellular Phones
	Notebook Computers
	PDA's

Selector Guide

PART	NO. OF AMPS	SHUTDOWN	PIN-PACKAGE
MAX4240	1	—	5-pin SOT23
MAX4241	1	Yes	8-pin μ MAX/SO
MAX4242	2	—	8-pin μ MAX/SO
MAX4243	2	Yes	10-pin μ MAX, 14-pin SO
MAX4244	4	—	14-pin SO

Beyond-the-Rails is a trademark and μ MAX is a registered trademark of Maxim Integrated Products, Inc.

Features

- ◆ **Ultra-Low-Voltage Operation:**
Guaranteed Down to +1.8V
Typical Operation to +1.5V
- ◆ **Ultra-Low Power Consumption:**
10 μ A Supply Current per Amplifier
1 μ A Shutdown Mode (MAX4241/MAX4243)
Up to 200,000 Hours Operation from Two AA Alkaline Cells
- ◆ **Beyond-the-Rails Input Common-Mode Range**
- ◆ **Outputs Swing Rail-to-Rail**
- ◆ **No Phase Reversal for Overdriven Inputs**
- ◆ **200 μ V Input Offset Voltage**
- ◆ **Unity-Gain Stable for Capacitive Loads up to 200pF**
- ◆ **90kHz Gain-Bandwidth Product**
- ◆ **Available in Space-Saving 5-Pin SOT23 and 8-Pin μ MAX® Packages**

Ordering Information

PART	TEMP RANGE	PIN-PACKAGE	TOP MARK
MAX4240EUK-T	-40°C to +85°C	5 SOT23-5	ACCS
MAX4241EUA	-40°C to +85°C	8 μ MAX	—
MAX4241ESA	-40°C to +85°C	8 SO	—
MAX4242EUA	-40°C to +85°C	8 μ MAX	—
MAX4242ESA	-40°C to +85°C	8 SO	—
MAX4243EUB	-40°C to +85°C	10 μ MAX	—
MAX4243ESD	-40°C to +85°C	14 SO	—
MAX4244ESD	-40°C to +85°C	14 SO	—

Pin Configurations

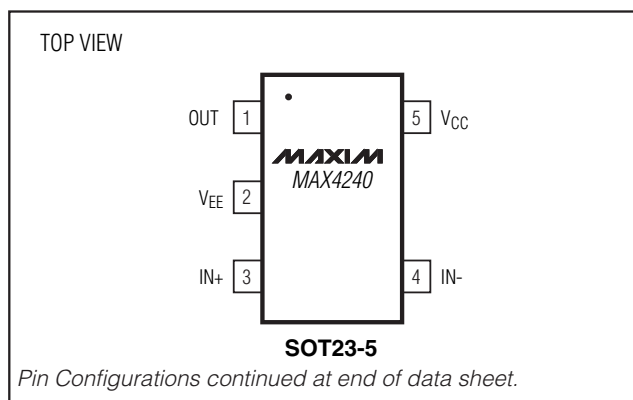

Single/Dual/Quad, +1.8V/10 μ A, SOT23, Beyond-the-Rails Op Amps

ABSOLUTE MAXIMUM RATINGS

Supply Voltage (V _{CC} to V _{EE}).....6V	10-pin μ MAX (derate 5.6mW/°C above +70°C)444mW
All Other Pins(V _{CC} + 0.3V) to (V _{EE} - 0.3V)	14-pin SO (derate 8.33mW/°C above +70°C).....667mW
Output Short-Circuit Duration (to V _{CC} or V _{EE}).....Continuous	Operating Temperature Range-40°C to +85°C
Continuous Power Dissipation (T _A = +70°C)	Junction Temperature+150°C
5-pin SOT23 (derate 7.1mW/°C above +70°C).....571mW	Storage Temperature Range-65°C to +160°C
8-pin μ MAX (derate 4.1mW/°C above +70°C).....330mW	Lead Temperature (soldering, 10s)+300°C
8-pin SO (derate 5.88mW/°C above +70°C).....471mW	

Stresses beyond those listed under "Absolute Maximum Ratings" may cause permanent damage to the device. These are stress ratings only, and functional operation of the device at these or any other conditions beyond those indicated in the operational sections of the specifications is not implied. Exposure to absolute maximum rating conditions for extended periods may affect device reliability.

ELECTRICAL CHARACTERISTICS

(V_{CC} = +1.8V to +5.5V, V_{EE} = 0, V_{CM} = 0, V_{OUT} = V_{CC} / 2, R_L = 100k Ω tied to V_{CC} / 2, $\overline{\text{SHDN}}$ = V_{CC}, T_A = +25°C, unless otherwise noted.) (Note 1)

PARAMETER	SYMBOL	CONDITIONS		MIN	TYP	MAX	UNITS
Supply-Voltage Range	V _{CC}	Inferred from PSRR test		1.8		5.5	V
Supply Current per Amplifier	I _{CC}	$\overline{\text{SHDN}} = \text{V}_{\text{CC}}$	V _{CC} = 1.8V		10	12	μ A
			V _{CC} = 5.0V		14	18	
Shutdown Supply Current (Note 2)	I _{CC} ($\overline{\text{SHDN}}$)	$\overline{\text{SHDN}} = \text{V}_{\text{EE}}$	V _{CC} = 1.8V		1.0	1.5	μ A
			V _{CC} = 5.0V		2.0	3.0	
Input Offset Voltage	V _{OS}	(V _{EE} - 0.2V) \leq V _{CM} \leq (V _{CC} + 0.2V)	MAX4241ESA		\pm 0.20	\pm 0.75	mV
			MAX4242ESA/MAX4243ESD/ MAX4244ESD		\pm 0.20	\pm 0.88	
			MAX4240EUK/MAX424_EUA/ MAX4243EUB		\pm 0.25	\pm 1.40	
Input Bias Current	I _B	(Note 3)			\pm 2	\pm 6	nA
Input Offset Current	I _{OS}	(Note 3)			\pm 0.5	\pm 1.5	nA
Differential Input Resistance	R _{IN} (DIFF)	V _{IN+} - V _{IN-} < 1.0V			45		M Ω
		V _{IN+} - V _{IN-} > 2.5V			4.4		k Ω
Input Common-Mode Voltage Range	V _{CM}	Inferred from the CMRR test		V _{EE} - 0.2		V _{CC} + 0.2	V
Common-Mode Rejection Ratio (Note 4)	CMRR	V _{CC} = 1.8V	MAX4241ESA		72	90	dB
			MAX4242ESA/MAX4243ESD/ MAX4244ESD		69	90	
			MAX4240EUK/MAX424_EUA/ MAX4243EUB		63	88	
		V _{CC} = 5.0V	MAX4241ESA		74	94	
			MAX4242ESA/MAX4243ESD/ MAX4244ESD		74	94	
			MAX4240EUK/MAX424_EUA/ MAX4243EUB		69	90	

Single/Dual/Quad, +1.8V/10 μ A, SOT23, Beyond-the-Rails Op Amps

MAX4240-MAX4244

ELECTRICAL CHARACTERISTICS (continued)

($V_{CC} = +1.8V$ to $+5.5V$, $V_{EE} = 0$, $V_{CM} = 0$, $V_{OUT} = V_{CC} / 2$, $R_L = 100k\Omega$ tied to $V_{CC} / 2$, $\overline{SHDN} = V_{CC}$, $T_A = +25^\circ C$, unless otherwise noted.) (Note 1)

PARAMETER	SYMBOL	CONDITIONS		MIN	TYP	MAX	UNITS	
Power-Supply Rejection Ratio	PSRR	$1.8V \leq V_{CC} \leq 5.5V$	MAX4241ESA	77	85		dB	
			MAX4242ESA/MAX4243ESD/ MAX4244ESD	77	85			
			MAX4240EUK/MAX424_EUA/ MAX4243EUB	75	82			
Large-Signal Voltage Gain	A_{VOL}	$(V_{EE} + 0.2V) \leq V_{OUT} \leq (V_{CC} - 0.2V)$	$V_{CC} = 1.8V$	$R_L = 100k\Omega$	76	85	dB	
				$R_L = 10k\Omega$	66	73		
			$V_{CC} = 5.0V$	$R_L = 100k\Omega$	86	94		
				$R_L = 10k\Omega$	78	85		
Output Voltage Swing High	V_{OH}	Specified as $ V_{CC} - V_{OH} $	$V_{CC} = 1.8V$	$R_L = 100k\Omega$		8	20	mV
				$R_L = 10k\Omega$		40	65	
			$V_{CC} = 5.0V$	$R_L = 100k\Omega$		10	25	
				$R_L = 10k\Omega$		60	95	
Output Voltage Swing Low	V_{OL}	Specified as $ V_{EE} - V_{OL} $	$V_{CC} = 1.8V$	$R_L = 100k\Omega$		6	15	mV
				$R_L = 10k\Omega$		23	35	
			$V_{CC} = 5.0V$	$R_L = 100k\Omega$		10	20	
				$R_L = 10k\Omega$		40	60	
Output Short-Circuit Current	$I_{OUT(SC)}$	Sourcing			0.7		mA	
		Sinking			2.5			
Output Leakage Current in Shutdown (Notes 2, 5)	$I_{OUT(\overline{SHDN})}$	$\overline{SHDN} = V_{EE} = 0$, $V_{CC} = 5.5V$			20	50	nA	
\overline{SHDN} Logic Low (Note 2)	V_{IL}					$0.3 \times V_{CC}$	V	
\overline{SHDN} Logic High (Note 2)	V_{IH}			$0.7 \times V_{CC}$			V	
\overline{SHDN} Input Bias Current (Note 2)	I_{IH} , I_{IL}	$\overline{SHDN} = V_{CC} = 5.5V$ or $\overline{SHDN} = V_{EE} = 0$			40	80	nA	
Channel-to-Channel Isolation (Note 6)	CH_{ISO}	Specified at DC			80		dB	
Gain-Bandwidth Product	GBW				90		kHz	
Phase Margin	Φ_m				68		degrees	
Gain Margin	G_m				18		dB	
Slew Rate	SR				40		V/ms	

Single/Dual/Quad, +1.8V/10 μ A, SOT23, Beyond-the-Rails Op Amps

ELECTRICAL CHARACTERISTICS (continued)

($V_{CC} = +1.8V$ to $+5.5V$, $V_{EE} = 0$, $V_{CM} = 0$, $V_{OUT} = V_{CC} / 2$, $R_L = 100k\Omega$ tied to $V_{CC} / 2$, $\overline{SHDN} = V_{CC}$, $T_A = +25^\circ C$, unless otherwise noted.) (Note 1)

PARAMETER	SYMBOL	CONDITIONS	MIN	TYP	MAX	UNITS
Input Voltage-Noise Density	e_n	$f = 1kHz$		70		nV/\sqrt{Hz}
Input Current-Noise Density	i_n	$f = 1kHz$		0.05		pA/\sqrt{Hz}
Capacitive-Load Stability		$A_{VCL} = +1V/V$, no sustained oscillations		200		pF
Shutdown Time	t_{SHDN}			50		μs
Enable Time from Shutdown	t_{ENABLE}			150		μs
Power-Up Time	t_{ON}			200		μs
Input Capacitance	C_{IN}			3		pF
Total Harmonic Distortion	THD	$f_{IN} = 1kHz$, $V_{CC} = 5.0V$, $V_{OUT} = 2V_{p-p}$, $A_V = +1V/V$		0.05		%
Settling Time to 0.01%	t_S	$A_V = +1V/V$, $V_{CC} = 5.0V$, $V_{OUT} = 2V_{STEP}$		50		μs

ELECTRICAL CHARACTERISTICS

($V_{CC} = +1.8V$ to $+5.5V$, $V_{EE} = 0$, $V_{CM} = 0$, $V_{OUT} = V_{CC} / 2$, $R_L = 100k\Omega$ tied to $V_{CC} / 2$, $\overline{SHDN} = V_{CC}$, $T_A = T_{MIN}$ to T_{MAX} , unless otherwise noted.) (Note 1)

PARAMETER	SYMBOL	CONDITIONS	MIN	TYP	MAX	UNITS
Supply-Voltage Range	V_{CC}	Inferred from PSRR test	1.8		5.5	V
Supply Current per Amplifier	I_{CC}	$\overline{SHDN} = V_{CC}$	$V_{CC} = 1.8V$		14	μA
			$V_{CC} = 5.0V$		19	
Shutdown Supply Current (Note 2)	$I_{CC}(\overline{SHDN})$	$\overline{SHDN} = V_{EE}$	$V_{CC} = 1.8V$		2.0	μA
			$V_{CC} = 5.0V$		3.5	
Input Offset Voltage	V_{OS}	$(V_{EE} - 0.2V) \leq V_{CM} \leq (V_{CC} + 0.2V)$	MAX4241ESA		± 1.2	mV
			MAX4242ESA/MAX4243ESD/ MAX4244ESD		± 1.3	
			MAX4240EUK/MAX424_EUA/ MAX4243EUB		± 2.0	
Input Offset Voltage Drift	TC_{VOS}			2		$\mu V/^\circ C$
Input Bias Current	I_B	(Note 3)			± 15	nA
Input Offset Current	I_{OS}	(Note 3)			± 7	nA
Input Common-Mode Voltage Range	V_{CM}	Inferred from the CMRR test	-0.2	$V_{CC} + 0.2$		V

Single/Dual/Quad, +1.8V/10 μ A, SOT23, Beyond-the-Rails Op Amps

MAX4240-MAX4244

ELECTRICAL CHARACTERISTICS

($V_{CC} = +1.8V$ to $+5.5V$, $V_{EE} = 0$, $V_{CM} = 0$, $V_{OUT} = V_{CC} / 2$, $R_L = 100k\Omega$ tied to $V_{CC} / 2$, $\overline{SHDN} = V_{CC}$, $T_A = T_{MIN}$ to T_{MAX} , unless otherwise noted.) (Note 1)

PARAMETER	SYMBOL	CONDITIONS		MIN	TYP	MAX	UNITS
Common-Mode Rejection Ratio (Note 4)	CMRR	$V_{CC} = 1.8V$	MAX4241ESA	65			dB
			MAX4242ESA/MAX4243ESD/ MAX4244ESD	65			
			MAX4240EUK/MAX424_EUA/ MAX4243EUB	61			
		$V_{CC} = 5.0V$	MAX4241ESA	71			
			MAX4242ESA/MAX4243ESD/ MAX4244ESD	71			
			MAX4240EUK/MAX424_EUA/ MAX4243EUB	67			
Power-Supply Rejection Ratio	PSRR	$1.8V \leq V_{CC} \leq 5.5V$	MAX4241ESA	73			dB
			MAX4242ESA/MAX4243ESD/ MAX4244ESD	73			
			MAX4240EUK/MAX424_EUA/ MAX4243EUB	71			
Large-Signal Voltage Gain	A_{VOL}	$(V_{EE} + 0.2V) \leq V_{OUT} \leq (V_{CC} - 0.2V)$	$V_{CC} = 1.8V$	$R_L = 100k\Omega$	72		dB
				$R_L = 10k\Omega$	62		
			$V_{CC} = 5.0V$	$R_L = 100k\Omega$	80		
				$R_L = 10k\Omega$	72		
Output Voltage Swing High	V_{OH}	Specified as $ V_{CC} - V_{OH} $	$V_{CC} = 1.8V$	$R_L = 100k\Omega$		25	mV
				$R_L = 10k\Omega$		95	
			$V_{CC} = 5.0V$	$R_L = 100k\Omega$		30	
				$R_L = 10k\Omega$		145	
Output Voltage Swing Low	V_{OL}	Specified as $ V_{EE} - V_{OL} $	$V_{CC} = 1.8V$	$R_L = 100k\Omega$		20	mV
				$R_L = 10k\Omega$		50	
			$V_{CC} = 5.0V$	$R_L = 100k\Omega$		25	
				$R_L = 10k\Omega$		75	
Output Leakage Current in Shutdown (Notes 2, 5)	$I_{OUT(SHDN)}$	$\overline{SHDN} = V_{EE} = 0$, $V_{CC} = 5.5V$				100	nA
\overline{SHDN} Logic Low (Note 2)	V_{IL}					$0.3 \times V_{CC}$	V

Single/Dual/Quad, +1.8V/10 μ A, SOT23, Beyond-the-Rails Op Amps

ELECTRICAL CHARACTERISTICS (continued)

($V_{CC} = +1.8V$ to $+5.5V$, $V_{EE} = 0$, $V_{CM} = 0$, $V_{OUT} = V_{CC} / 2$, $R_L = 100k\Omega$ tied to $V_{CC} / 2$, $\overline{SHDN} = V_{CC}$, $T_A = T_{MIN}$ to T_{MAX} , unless otherwise noted.) (Note 1)

PARAMETER	SYMBOL	CONDITIONS	MIN	TYP	MAX	UNITS
SHDN Logic High (Note 2)	V_{IH}		$0.7 \times V_{CC}$			V
SHDN Input Bias Current (Note 2)	I_{IH} , I_{IL}	$\overline{SHDN} = V_{CC} = 5.5V$ or $\overline{SHDN} = V_{EE} = 0$	120			nA

Note 1: The MAX4240EUK, MAX4241EUA, MAX4242EUA, and MAX4243EUB specifications are 100% tested at $T_A = +25^\circ C$. All temperature limits are guaranteed by design.

Note 2: Shutdown mode applies to the MAX4241/MAX4243 only.

Note 3: Input bias current and input offset current are tested with $V_{CC} = +0.5V$ and $+0.5V \leq V_{CM} \leq +4.5V$.

Note 4: Tested over the specified input common-mode range.

Note 5: Tested for $0 \leq V_{OUT} \leq V_{CC}$. Does not include current through external feedback network.

Note 6: Channel-to-channel isolation specification applies to the MAX4242/MAX4243/MAX4244 only.

Typical Operating Characteristics

($V_{CC} = +5.0V$, $V_{EE} = 0$, $V_{CM} = V_{CC} / 2$, $\overline{VSHDN} = V_{CC}$, $R_L = 100k\Omega$ to $V_{CC} / 2$, $T_A = +25^\circ C$, unless otherwise noted.)

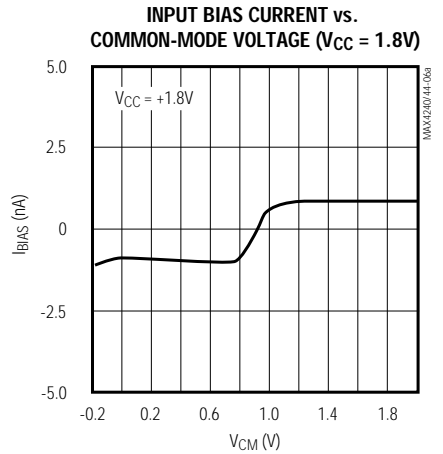
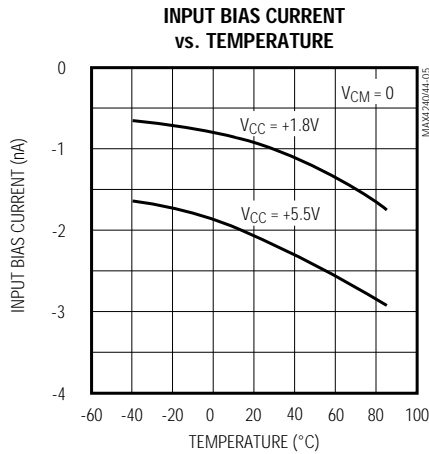
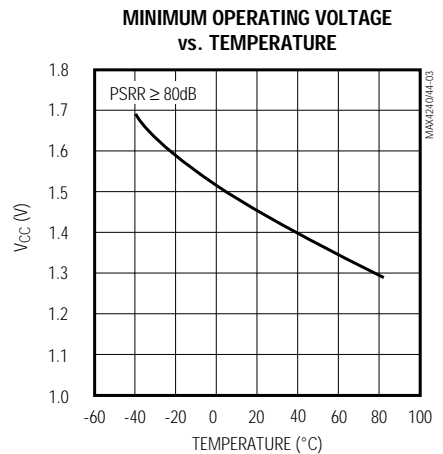
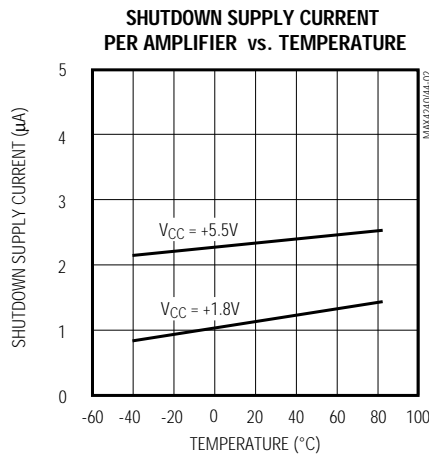
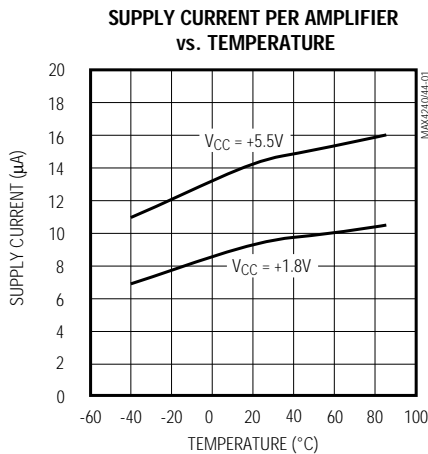

Single/Dual/Quad, +1.8V/10 μ A, SOT23, Beyond-the-Rails Op Amps

Typical Operating Characteristics (continued)

($V_{CC} = +5.0V$, $V_{EE} = 0$, $V_{CM} = V_{CC} / 2$, $V_{SHDN} = V_{CC}$, $R_L = 100k\Omega$ to $V_{CC} / 2$, $T_A = +25^\circ C$, unless otherwise noted.)

MAX4240-MAX4244

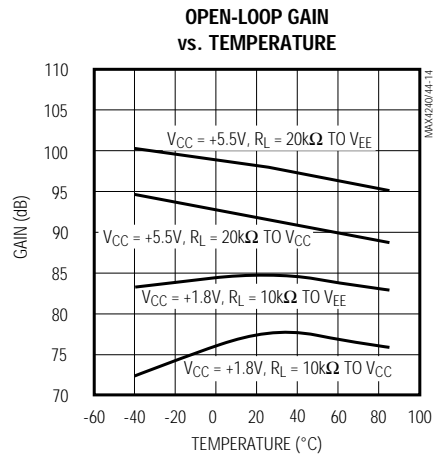
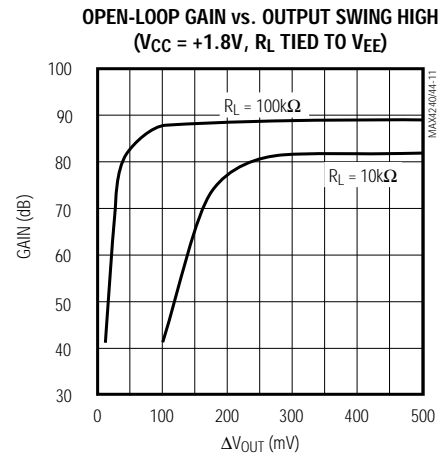
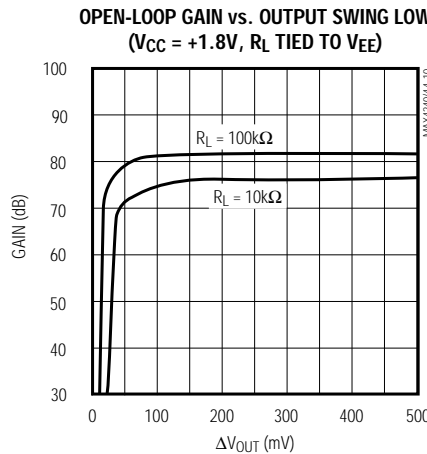
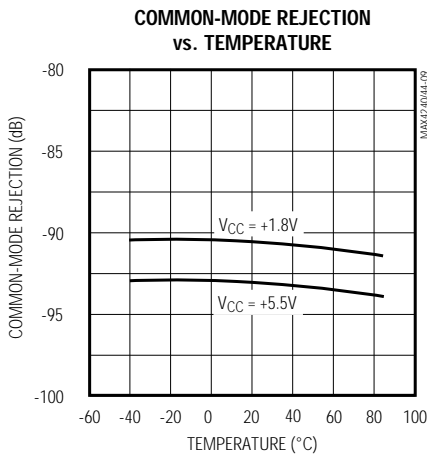
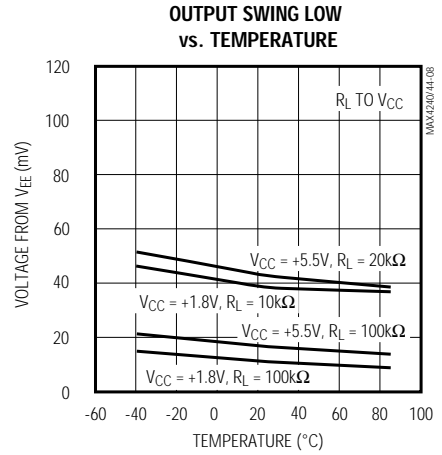
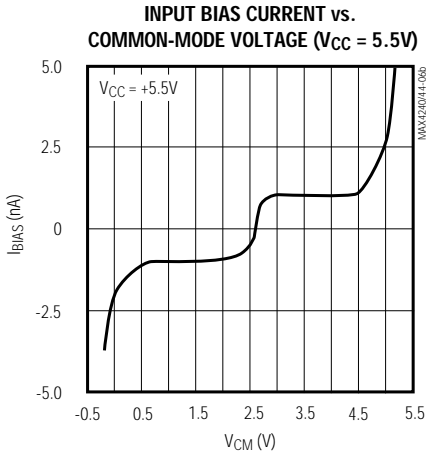

Single/Dual/Quad, +1.8V/10 μ A, SOT23, Beyond-the-Rails Op Amps

Typical Operating Characteristics (continued)

($V_{CC} = +5.0V$, $V_{EE} = 0$, $V_{CM} = V_{CC}/2$, $V_{SHDN} = V_{CC}$, $R_L = 100k\Omega$ to $V_{CC}/2$, $T_A = +25^\circ C$ unless otherwise noted.)

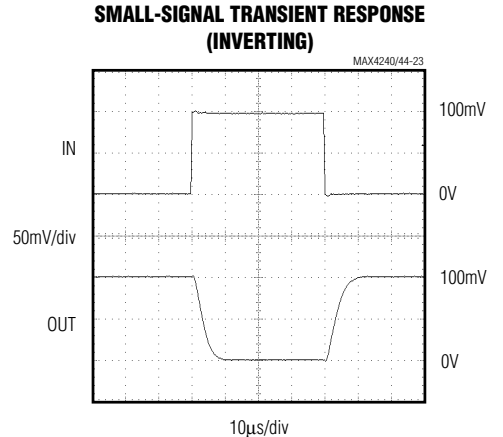
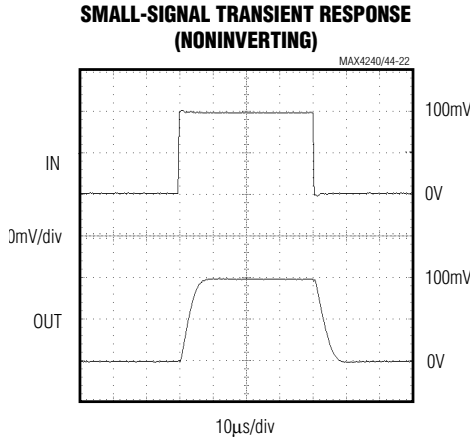
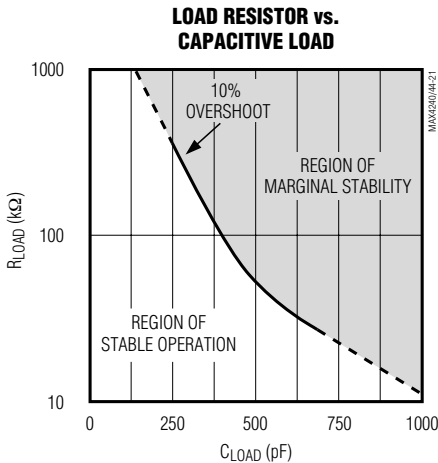
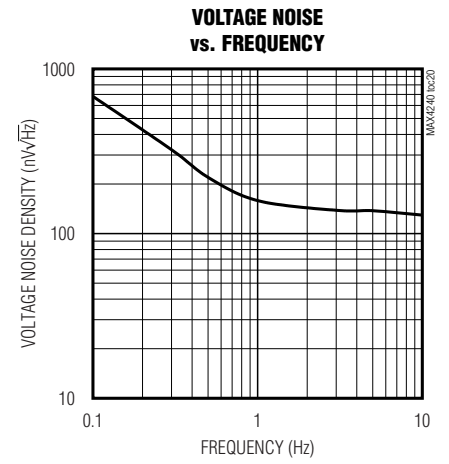
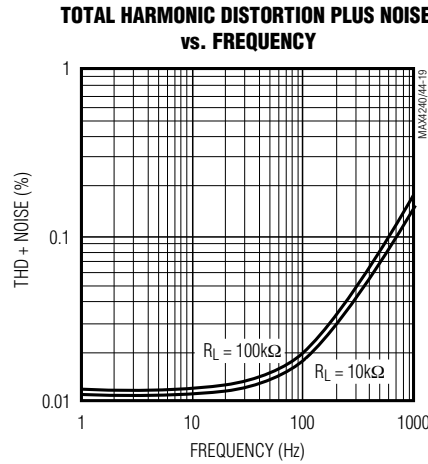
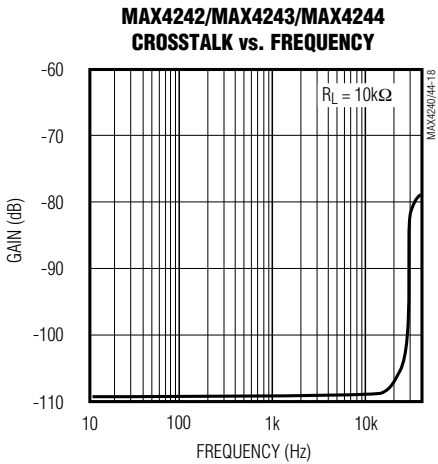
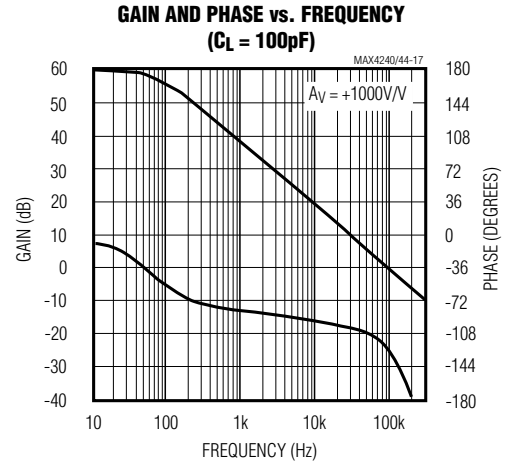
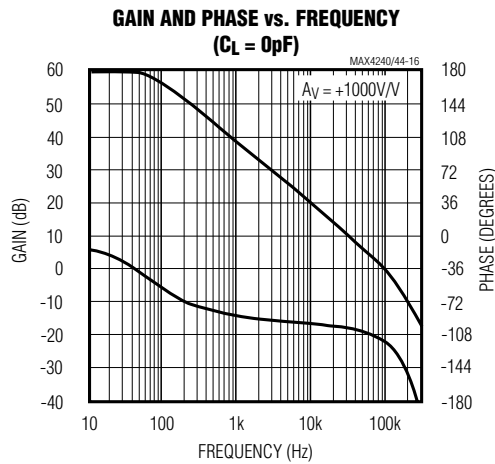
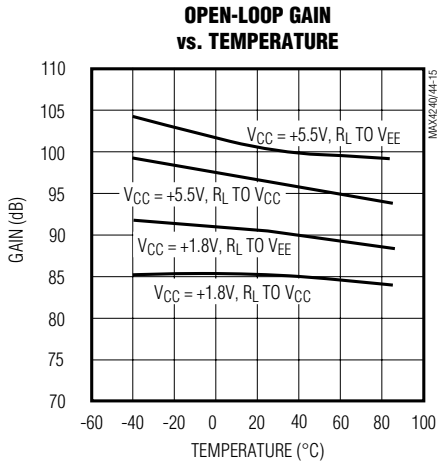

Single/Dual/Quad, +1.8V/10 μ A, SOT23, Beyond-the-Rails Op Amps

Typical Operating Characteristics (continued)

($V_{CC} = +5.0V$, $V_{EE} = 0$, $V_{CM} = V_{CC}/2$, $V_{SHDN} = V_{CC}$, $R_L = 100k\Omega$ to $V_{CC}/2$, $T_A = +25^\circ C$ unless otherwise noted.)

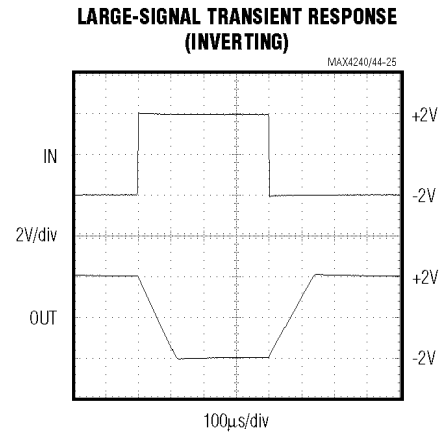
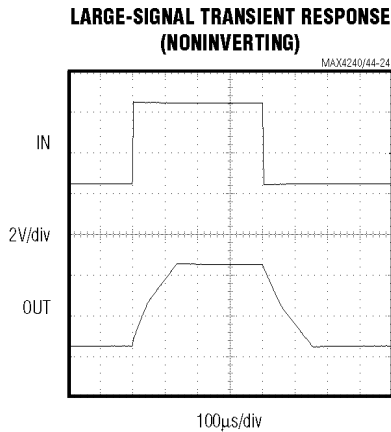

Pin Description

PIN						NAME	FUNCTION
MAX4240	MAX4241	MAX4242	MAX4243		MAX4244		
			μ MAX	SO			
1	6	—	—	—	—	OUT	Amplifier Output. High impedance when in shutdown mode.
2	4	4	4	4	11	V_{EE}	Negative Supply. Tie to ground for single-supply operation.
3	3	—	—	—	—	IN+	Noninverting Input
4	2	—	—	—	—	IN-	Inverting Input
5	7	8	10	14	4	V_{CC}	Positive Supply
—	1, 5	—	—	5, 7, 8, 10	—	N.C.	No Connection. Not internally connected.
—	8	—	—	—	—	\overline{SHDN}	Shutdown Input. Drive high, or tie to V_{CC} for normal operation. Drive to V_{EE} to place device in shutdown mode.
—	—	1, 7	1, 9	1, 13	1, 7	OUTA, OUTB	Outputs for Amplifiers A and B. High impedance when in shutdown mode.
—	—	2, 6	2, 8	2, 12	2, 6	INA-, INB-	Inverting Inputs to Amplifiers A and B
—	—	3, 5	3, 7	3, 11	3, 5	INA+, INB+	Noninverting Inputs to Amplifiers A and B
—	—	—	5, 6	6, 9	—	\overline{SHDNA} , \overline{SHDNB}	Shutdown Inputs for Amplifiers A and B. Drive high, or tie to V_{CC} for normal operation. Drive to V_{EE} to place device in shutdown mode.
—	—	—	—	—	8, 14	OUTC, OUTD	Outputs for Amplifiers C and D
—	—	—	—	—	9, 13	INC-, IND-	Inverting Inputs to Amplifiers C and D
—	—	—	—	—	10, 12	INC+, IND+	Noninverting Inputs to Amplifiers C and D

MAX4240-MAX4244

Single/Dual/Quad, +1.8V/10μA, SOT23, Beyond-the-Rails Op Amps

Detailed Description

Beyond-the-Rails Input Stage

The MAX4240–MAX4244 have Beyond-the-Rails inputs and rail-to-rail output stages that are specifically designed for low-voltage, single-supply operation. The input stage consists of separate NPN and PNP differential stages, which operate together to provide a common-mode range extending to 200mV beyond both supply rails. The crossover region of these two pairs of supply rails. The input offset voltage is typically 200μV. Low operating supply voltage, low supply current, beyond-the-rails common-mode input range, and rail-to-rail outputs make this family of operational amplifiers an excellent choice for precision or general-purpose, low-voltage battery-powered systems.

Since the input stage consists of NPN and PNP pairs, the input bias current changes polarity as the common-mode voltage passes through the crossover region. Match the effective impedance seen by each input to reduce the offset error caused by input bias currents flowing through external source impedances (Figures 1a and 1b). The combination of high source impedance plus input capacitance (amplifier input capacitance plus stray capacitance) creates a parasitic pole that produces an underdamped signal response. Reducing input capacitance or placing a small capacitor across the feedback resistor improves response in this case.

The MAX4240–MAX4244 family's inputs are protected from large differential input voltages by internal 2.2kΩ series resistors and back-to-back triple-diode stacks across the inputs (Figure 2). For differential input voltages (much less than 1.8V), input resistance is typically 45MΩ. For differential input voltages greater than 1.8V, input resistance is around 4.4kΩ, and the input bias current can be approximated by the following equation:

$$I_{BIAS} = (V_{DIFF} - 1.8V) / 4.4k\Omega$$

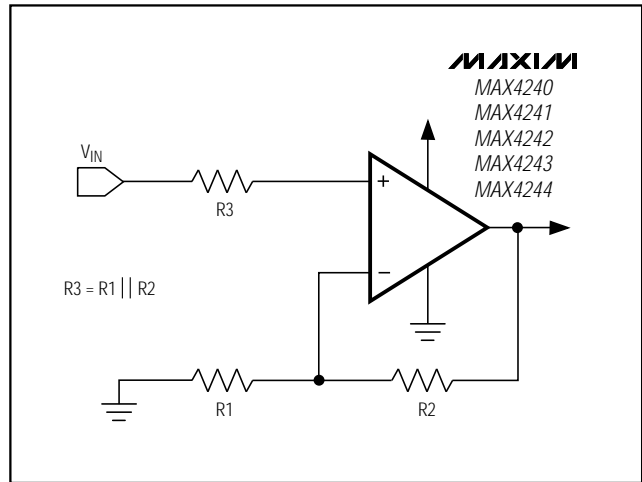

Figure 1a. Minimizing Offset Error Due to Input Bias Current (Noninverting)



Figure 1b. Minimizing Offset Error Due to Input Bias Current (Inverting)

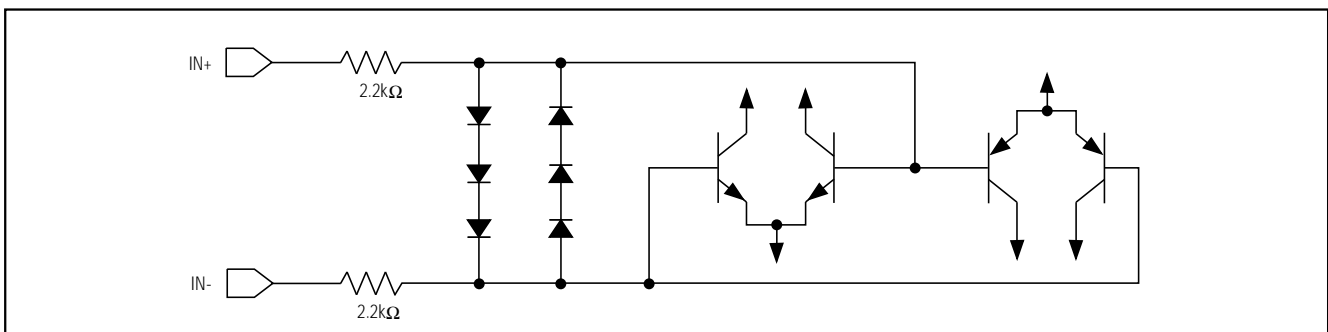

Figure 2. Input Protection Circuit

Single/Dual/Quad, +1.8V/10 μ A, SOT23, Beyond-the-Rails Op Amps

In the region where the differential input voltage approaches 1.8V, the input resistance decreases exponentially from 45M Ω to 4.4k Ω as the diode block begins conducting. Conversely, the bias current increases with the same curve.

Rail-to-Rail Output Stage

The MAX4240-MAX4244 output stage can drive up to a 10k Ω load and still swing to within 40mV of the rails. Figure 3 shows the output voltage swing of a MAX4240 configured as a unity-gain buffer, powered from a single +2V supply voltage. The output for this setup typically swings from (V_{EE} + 6mV) to (V_{CC} - 8mV) with a 100k Ω load.

Applications Information

Power-Supply Considerations

The MAX4240-MAX4244 operate from a single +1.8V to +5.5V supply (or dual \pm 0.9V to \pm 2.75V supplies) and consume only 10 μ A of supply current per amplifier. A high power-supply rejection ratio of 85dB allows the amplifiers to be powered directly off a decaying battery voltage, simplifying design and extending battery life.

The MAX4240-MAX4244 are ideally suited for use with most battery-powered systems. Table 1 lists a variety of typical battery types showing voltage when fresh, voltage at end-of-life, capacity, and approximate operating time from a MAX4240/MAX4241, assuming nominal conditions for both normal and shutdown modes.

Although the amplifiers are fully guaranteed over temperature for operation down to a +1.8V single supply, even lower-voltage operation is possible in practice. Figures 4 and 5 show the PSRR and supply current as a function of supply voltage and temperature.

Power-Up Settling Time

The MAX4240-MAX4244 typically require 200 μ s to power up after V_{CC} is stable. During this start-up time, the output is indeterminate. The application circuit should allow for this initial delay.

Shutdown Mode

The MAX4241 (single) and MAX4243 (dual) feature a low-power shutdown mode. When the shutdown pin (SHDN) is pulled low, the supply current drops to 1 μ A per amplifier, the amplifier is disabled, and the outputs enter a high-impedance state. Pulling SHDN high or leaving it floating enables the amplifier. Take care to ensure that parasitic leakage current at the SHDN pin does not inadvertently place the part into shutdown mode when SHDN is left floating. Figure 6 shows the output voltage response to a shutdown pulse. The logic threshold for SHDN is always referred to V_{CC} / 2 (not to

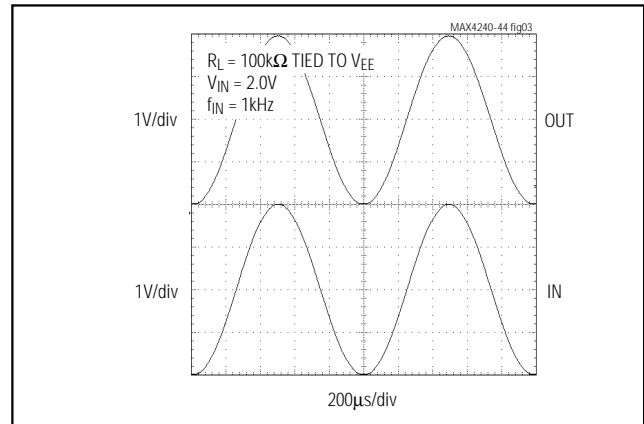

Figure 3. Rail-to-Rail Input/Output Voltage Range

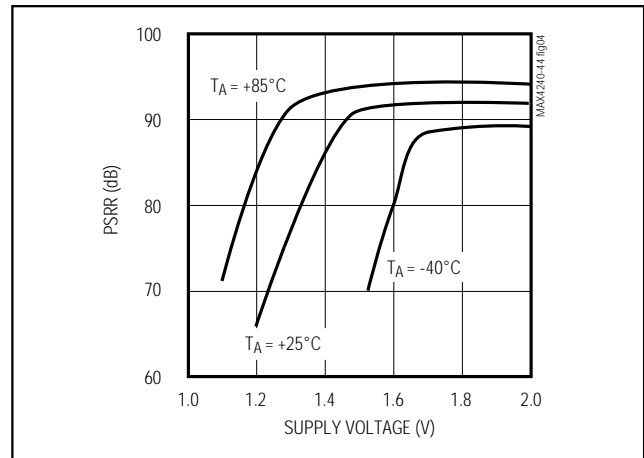

Figure 4. Power-Supply Rejection Ratio vs. Supply Voltage

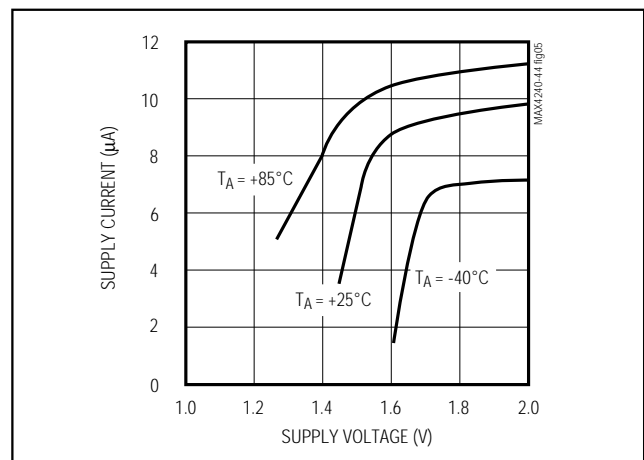

Figure 5. Supply Current vs. Supply Voltage

Single/Dual/Quad, +1.8V/10 μ A, SOT23, Beyond-the-Rails Op Amps

Table 1. MAX4240/MAX4241 Characteristics with Typical Battery Systems

BATTERY TYPE	RECHARGEABLE	V _{FRESH} (V)	V _{END-OF-LIFE} (V)	CAPACITY, AA SIZE (mA-h)	MAX4240/MAX4241 OPERATING TIME IN NORMAL MODE (Hours)	MAX4241 OPERATING TIME IN SHUTDOWN MODE (Hours)
Alkaline (2 Cells)	No	3.0	1.8	2000	200,000	2 x 10 ⁶
Nickel-Cadmium (2 Cells)	Yes	2.4	1.8	750	75,000	0.75 x 10 ⁶
Lithium-Ion (1 Cell)	Yes	3.5	2.7	1000	100,000	10 ⁶
Nickel-Metal-Hydrate (2 Cells)	Yes	2.4	1.8	1000	100,000	10 ⁶

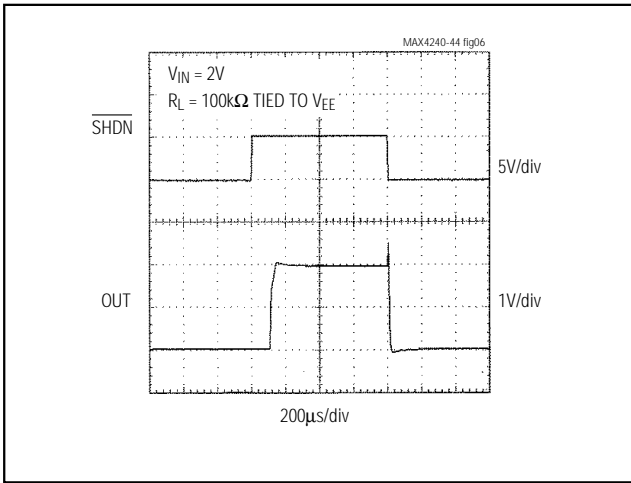

Figure 6. Shutdown Enable/Disable Output Voltage

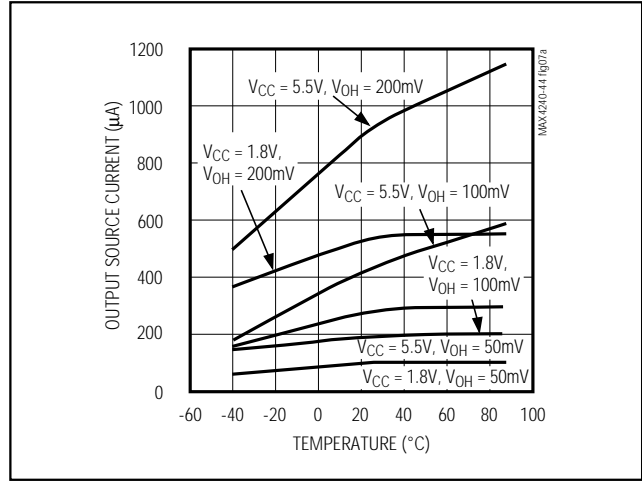

Figure 7a. Output Source Current vs. Temperature

GND). When using dual supplies, pull $\overline{\text{SHDN}}$ to V_{EE} to enter shutdown mode.

Load-Driving Capability

The MAX4240-MAX4244 are fully guaranteed over temperature and supply voltage to drive a maximum resistive load of $10\text{k}\Omega$ to $V_{CC} / 2$, although heavier loads can be driven in many applications. The rail-to-rail output stage of the amplifier can be modeled as a current source when driving the load toward V_{CC} , and as a current sink when driving the load toward V_{EE} . The magnitude of this current source/sink varies with supply voltage, ambient temperature, and lot-to-lot variations of the units.

Figures 7a and 7b show the typical current source and sink capability of the MAX4240-MAX4244 family as a function of supply voltage and ambient temperature. The contours on the graph depict the output current

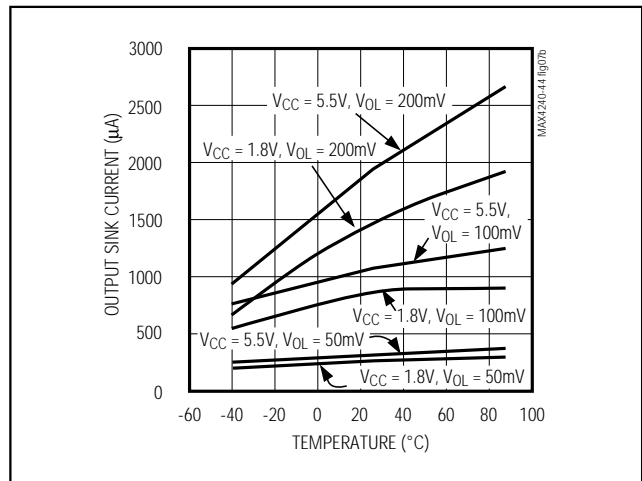

Figure 7b. Output Sink Current vs. Temperature

Single/Dual/Quad, +1.8V/10 μ A, SOT23, Beyond-the-Rails Op Amps

value, based on driving the output voltage to within 50mV, 100mV, and 200mV of either power-supply rail.

For example, a MAX4241 running from a single +1.8V supply, operating at $T_A = +25^\circ\text{C}$, can source 240 μA to within 100mV of V_{CC} and is capable of driving a 7k Ω load resistor to V_{EE} :

$$R_L = \frac{1.8\text{V} - 0.1\text{V}}{240\mu\text{A}} = 7\text{k}\Omega \text{ to } V_{EE}$$

The same application can drive a 3.3k Ω load resistor when terminated in $V_{CC} / 2$ (+0.9V in this case).

Driving Capacitive Loads

The MAX4240–MAX4244 are unity-gain stable for loads up to 200pF (see Load Resistor vs. Capacitive Load graph in *Typical Operating Characteristics*). Applications that require greater capacitive drive capability should use an isolation resistor between the output and the capacitive load (Figure 8). Note that this alternative results in a loss of gain accuracy because R_{ISO} forms a voltage divider with the load resistor.

Power-Supply Bypassing and Layout

The MAX4240–MAX4244 family operates from either a single +1.8V to +5.5V supply or dual $\pm 0.9\text{V}$ to $\pm 2.75\text{V}$ supplies. For single-supply operation, bypass the power supply with a 100nF capacitor to V_{EE} (in this case GND). For dual-supply operation, both the V_{CC}

and V_{EE} supplies should be bypassed to ground with separate 100nF capacitors.

Good PC board layout techniques optimize performance by decreasing the amount of stray capacitance at the op amp's inputs and output. To decrease stray capacitance, minimize trace lengths by placing external components as close as possible to the op amp. Surface-mount components are an excellent choice.

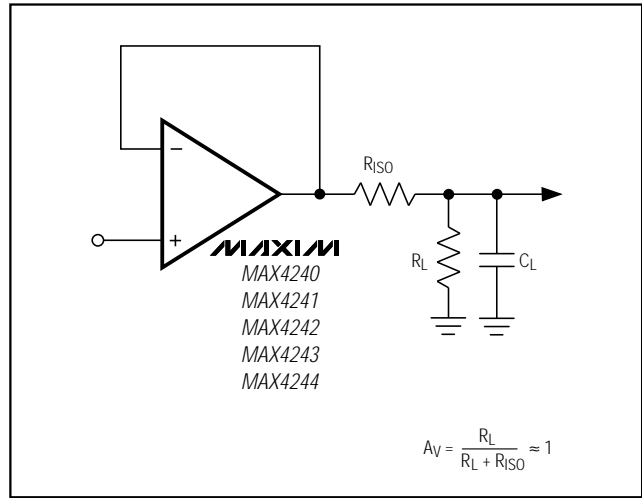

Figure 8a Using a Resistor to Isolate a Capacitive Load from the Op Amp

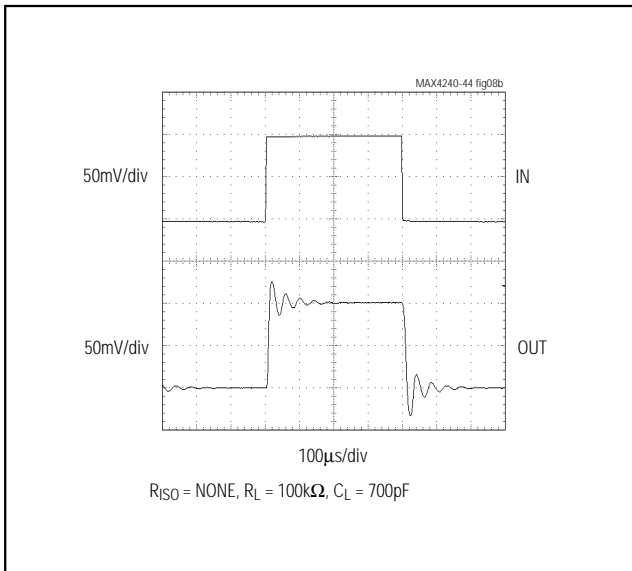

Figure 8b. Pulse Response without Isolating Resistor

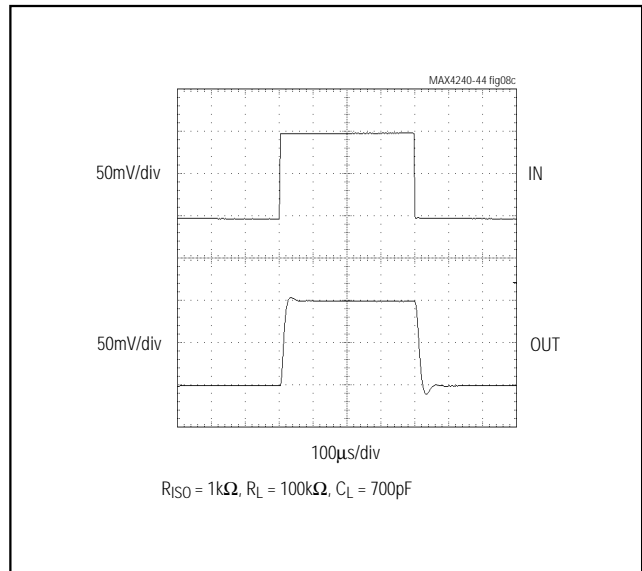

Figure 8c. Pulse Response with Isolating Resistor

Single/Dual/Quad, +1.8V/10µA, SOT23, Beyond-the-Rails Op Amps

Using the MAX4240-MAX4244 as Comparators

Although optimized for use as operational amplifiers, the MAX4240-MAX4244 can also be used as rail-to-rail I/O comparators. Typical propagation delay depends on the input overdrive voltage, as shown in Figure 9. External hysteresis can be used to minimize the risk of output oscillation. The positive feedback circuit, shown in Figure 10, causes the input threshold to change when the output voltage changes state. The two thresholds create a hysteresis band that can be calculated by the following equations:

$$V_{HYST} = V_{HI} - V_{LO}$$

$$V_{LO} = V_{IN} \times R2 / (R1 + (R1 \times R2 / R_{HYST}) + R2)$$

$$V_{HI} = [(R2 / R1 \times V_{IN}) + (R2 / R_{HYST}) \times V_{CC}] / (1 + R1 / R2 + R2 / R_{HYST})$$

The MAX4240-MAX4244 contain special circuitry to boost internal drive currents to the amplifier output stage. This maximizes the output voltage range over which the amplifiers are linear. In an open-loop comparator application, the excursion of the output voltage is so close to the supply rails that the output stage transistors will saturate, causing the quiescent current to increase from the normal 10µA. Typical quiescent currents increase to 35µA for the output saturating at V_{CC} and 28µA for the output at V_{EE}.

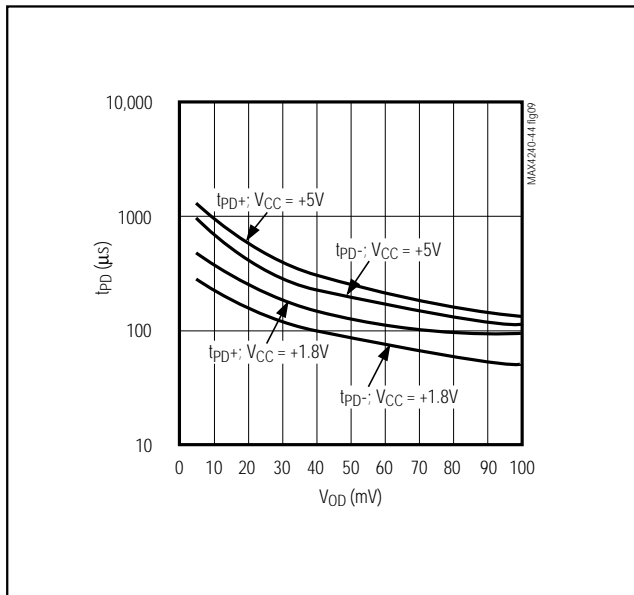

Figure 9. Propagation Delay vs. Input Overdrive

Using the MAX4240-MAX4244 as Ultra-Low-Power Current Monitors

The MAX4240-MAX4244 are ideal for applications powered from a 2-cell battery stack. Figure 11 shows an application circuit in which the MAX4240 is used for monitoring the current of a 2-cell battery stack. In this circuit, a current load is applied, and the voltage drop at the battery terminal is sensed.

The voltage on the load side of the battery stack is equal to the voltage at the emitter of Q1, due to the feedback loop containing the op amp. As the load current increases, the voltage drop across R1 and R2 increases. Thus, R2 provides a fraction of the load current (set by the ratio of R1 and R2) that flows into the emitter of the PNP transistor. Neglecting PNP base current, this current flows into R3, producing a ground-referenced voltage proportional to the load current. Scale R1 to give a voltage drop large enough in comparison to V_{OS} of the op amp, in order to minimize errors.

The output voltage of the application can be calculated using the following equation:

$$V_{OUT} = [I_{LOAD} \times (R1 / R2)] \times R3$$

For a 1V output and a current load of 50mA, the choice of resistors can be R1 = 2Ω, R2 = 100kΩ, R3 = 1MΩ. The circuit consumes less power (but is more susceptible to noise) with higher values of R1, R2, and R3.

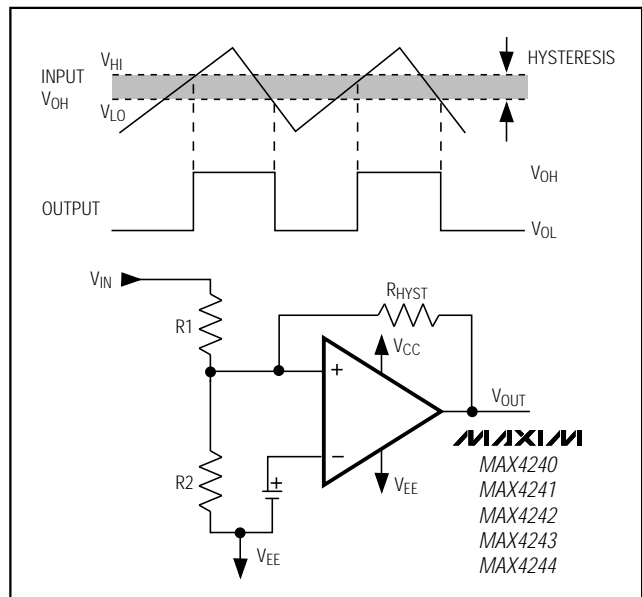

Figure 10. Hysteresis Comparator Circuit

Single/Dual/Quad, +1.8V/10 μ A, SOT23, Beyond-the-Rails Op Amps



Figure 11. Current Monitor for a 2-Cell Battery Stack

Chip Information

MAX4240/MAX4241

TRANSISTOR COUNT: 234

MAX4242/MAX4243

TRANSISTOR COUNT: 466

MAX4244

TRANSISTOR COUNT: 932

SUBSTRATE CONNECTED TO V_{EE}

MAX4240-MAX4244

Pin Configurations (continued)

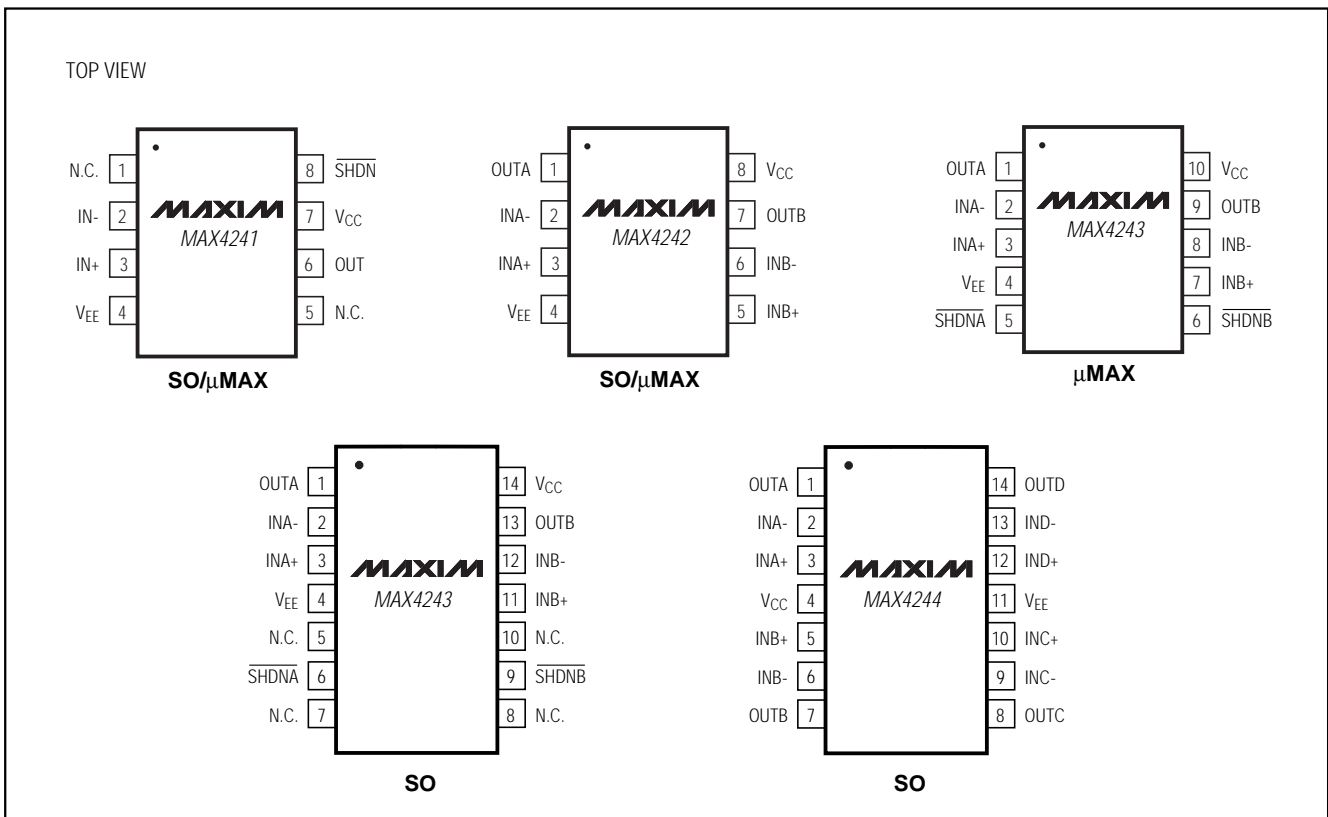

Single/Dual/Quad, +1.8V/10µA, SOT23, Beyond-the-Rails Op Amps

Tape-and-Reel Information

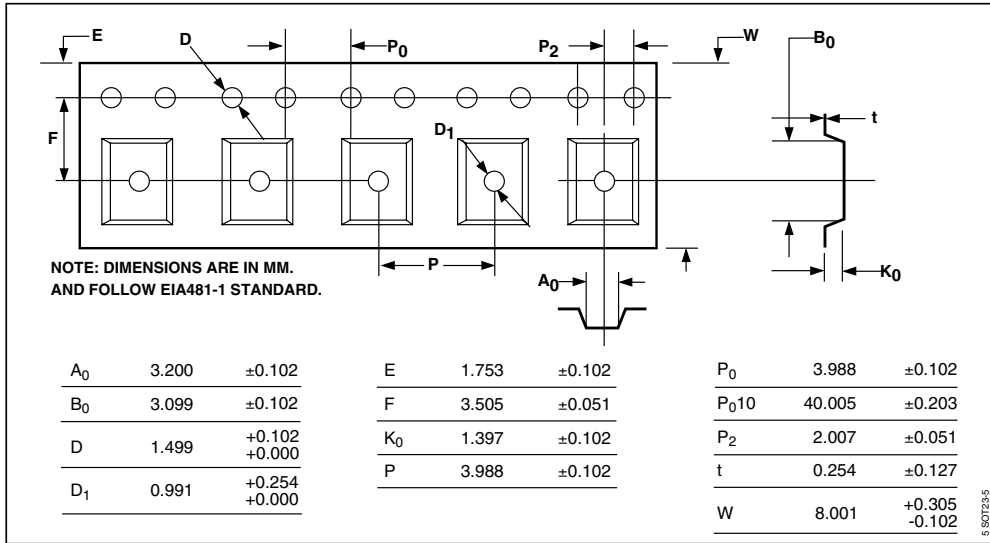

Package Information

(The package drawing(s) in this data sheet may not reflect the most current specifications. For the latest package outline information go to www.maxim-ic.com/packages.)

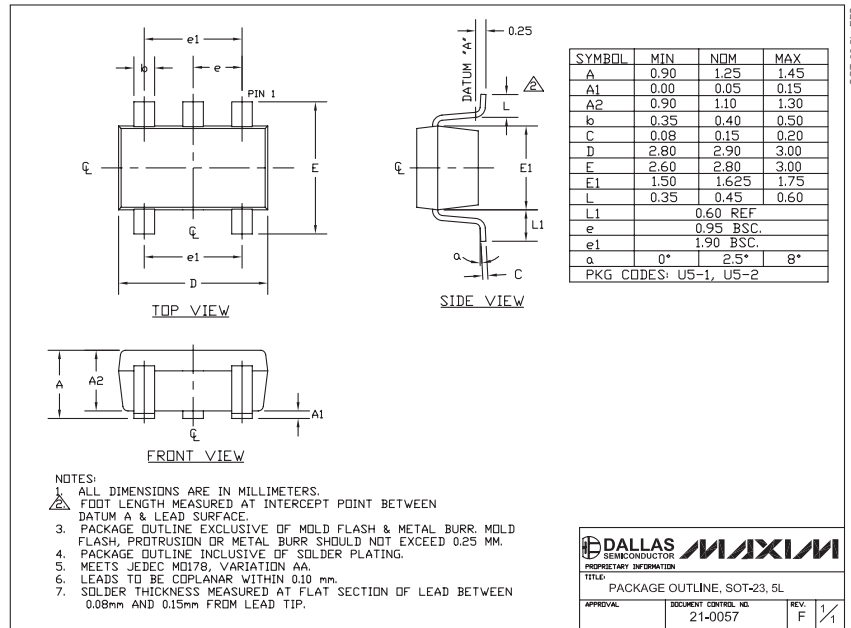

Revision History

Pages changed at Rev 3: 1, 8, 9, 16

Maxim cannot assume responsibility for use of any circuitry other than circuitry entirely embodied in a Maxim product. No circuit patent licenses are implied. Maxim reserves the right to change the circuitry and specifications without notice at any time.

16 **Maxim Integrated Products, 120 San Gabriel Drive, Sunnyvale, CA 94086 408-737-7600**

Компания «Океан Электроники» предлагает заключение долгосрочных отношений при поставках импортных электронных компонентов на взаимовыгодных условиях!

Наши преимущества:

- Поставка оригинальных импортных электронных компонентов напрямую с производств Америки, Европы и Азии, а так же с крупнейших складов мира;
- Широкая линейка поставок активных и пассивных импортных электронных компонентов (более 30 млн. наименований);
- Поставка сложных, дефицитных, либо снятых с производства позиций;
- Оперативные сроки поставки под заказ (от 5 рабочих дней);
- Экспресс доставка в любую точку России;
- Помощь Конструкторского Отдела и консультации квалифицированных инженеров;
- Техническая поддержка проекта, помощь в подборе аналогов, поставка прототипов;
- Поставка электронных компонентов под контролем ВП;
- Система менеджмента качества сертифицирована по Международному стандарту ISO 9001;
- При необходимости вся продукция военного и аэрокосмического назначения проходит испытания и сертификацию в лаборатории (по согласованию с заказчиком);
- Поставка специализированных компонентов военного и аэрокосмического уровня качества (Xilinx, Altera, Analog Devices, Intersil, Interpoint, Microsemi, Actel, Aeroflex, Peregrine, VPT, Syfer, Eurofarad, Texas Instruments, MS Kennedy, Miteq, Cobham, E2V, MA-COM, Hittite, Mini-Circuits, General Dynamics и др.);

Компания «Океан Электроники» является официальным дистрибьютором и эксклюзивным представителем в России одного из крупнейших производителей разъемов военного и аэрокосмического назначения «JONHON», а так же официальным дистрибьютором и эксклюзивным представителем в России производителя высокотехнологичных и надежных решений для передачи СВЧ сигналов «FORSTAR».



JONHON

«JONHON» (основан в 1970 г.)

Разъемы специального, военного и аэрокосмического назначения:

(Применяются в военной, авиационной, аэрокосмической, морской, железнодорожной, горно- и нефтедобывающей отраслях промышленности)

«FORSTAR» (основан в 1998 г.)

ВЧ соединители, коаксиальные кабели, кабельные сборки и микроволновые компоненты:

(Применяются в телекоммуникациях гражданского и специального назначения, в средствах связи, РЛС, а так же военной, авиационной и аэрокосмической отраслях промышленности).



Телефон: 8 (812) 309-75-97 (многоканальный)

Факс: 8 (812) 320-03-32

Электронная почта: ocean@oceanchips.ru

Web: <http://oceanchips.ru/>

Адрес: 198099, г. Санкт-Петербург, ул. Калинина, д. 2, корп. 4, лит. А