



Littelfuse®



Cole Hersee®
A Littelfuse® Brand

AFTERMARKET PRODUCTS CATALOG



Passenger and Commercial Vehicle Products

- Fuses & Fuse Holders
- Power Distribution
- Relays & Solenoids
- Switches
- Connectors



**ORIGINAL
EQUIPMENT
MANUFACTURER**

www.Littelfuse.com/aftermarket

Local Resources for a **GLOBAL** Market

Littelfuse products help protect, control and distribute vehicle electrical power in OEM and aftermarket applications for industries such as **heavy-duty truck, construction and agriculture.**

We offer a broad and reliable selection of **fuses, fuse blocks, power distribution modules, high-current switches, relays and solenoids** to fit your requirements.

For decades, we have helped OEMs, engineers and end-users select the right product for their applications. Today, Littelfuse offers the broadest range of products for protection, sensing, and control needs while providing exceptional service and support that our customers expect.

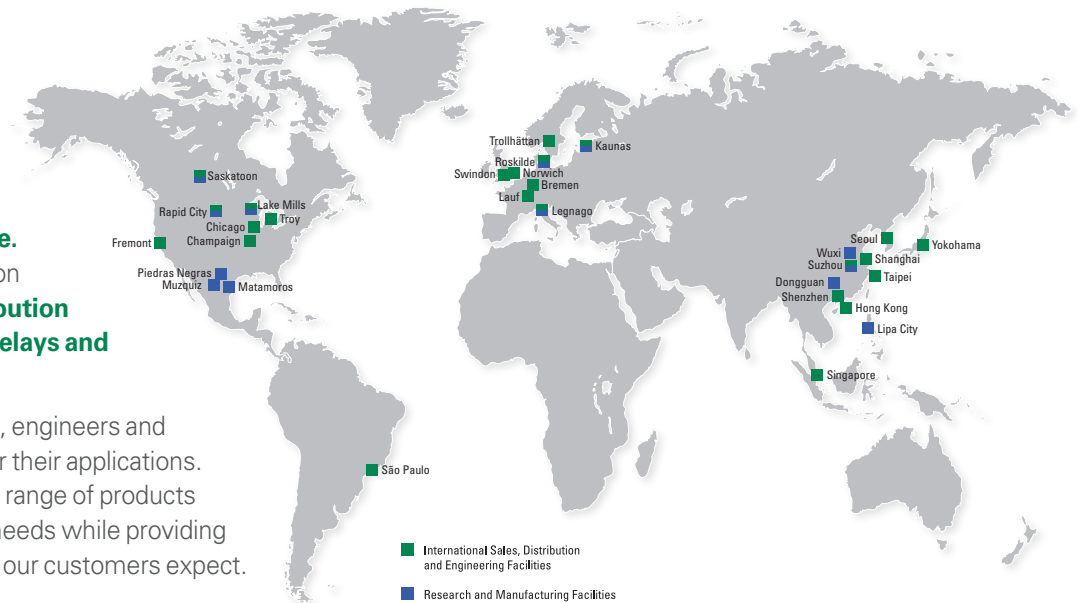

Market Focus **INDUSTRIES** and Applications



Truck & Bus

- On-Highway
- Severe Duty
- Transit Buses
- Vocational



Material Handling

- Fork Lifts
- Telehandlers
- Aerial Work Platform
- Pallet Jacks



Automotive Passenger Car

- OEM
- Motorsports
- Maintenance
- Fleets



Municipality

- Emergency
- Waste Trucks
- Fire & Rescue
- Utility



Construction & Agriculture

- Loaders
- Tractors
- Excavators
- Harvesters



Marine & Recreational

- Boats & Marine
- Golf Carts
- Recreation Vehicles
- ATV & Snowmobiles



Over 90 Years of Electrical Power Expertise



New **AFTERMARKET PRODUCTS** Now Available

MCASE+ Fuses



| COLOR CODE | CURRENT RATING (A) | CARDED 1-PC |
|------------|--------------------|---------------------|
| | | SLOTTED PART NUMBER |
| Gray | 15 | MCAS015.XPS |
| Blue | 20 | MCAS020.XPS |
| White | 25 | MCAS025.XPS |
| Pink | 30 | MCAS030.XPS |
| Green | 40 | MCAS040.XPS |

FHZ Fuse Holders



| Part Number | Description | Coming Soon |
|-------------|--|-------------|
| 0FHZ0001Z | 5-Stud Assembly with Bolts and Bus Bar | |
| 0FHZ0002Z | 5-Stud Full Assembly with M10 Input | |
| 0FHZ0003Z | 5-Stud Box Only for Configuration | |
| 0FHZ0005Z | 5-Stud Full Assembly with M8 Input | |
| 0FHZ0006Z | 7-Stud Assembly with Bolts and Bus Bar | |
| 0FHZ0007Z | 7-Stud Full Assembly with M10 Input | |
| 0FHZ0008Z | 7-Stud Box Only for Configuration | |
| 0FHZ0009Z | 7-Stud Full Assembly with M8 Input | |

Additional RedBox Blade Fuse Module Tray



| Part Number | Description |
|--------------|--|
| ORBOX003ZGLO | ATO, MINI, and MAXI SmartGlow Fuses, Fuse Pullers, ATO and MINI HD In-Line Fuse Holders 272 Piece Assortment |

Contact your local sales manager for more information

Updated **COLE HERSEE BRAND** Packaging



Former Design

New Design

Cole Hersee – A Littelfuse Brand joint logo promoting the relationship between the brands.



Blue and yellow Cole Hersee **brand colors** remain prominent for fast identification.

Large, **easy-to-read label with part number and description** for quick product selection.

Enhanced **installation information** and detailed descriptions included in the packaging.

Heavy-duty box packaging protects products in distribution environment.

Heavy-duty clamshell packaging protects products in retail environment.

Matching blister product for a consistent and attractive product display.



Former Design

New Design

Table of Contents

Circuit Protection - Fuses & Circuit Breakers

| | |
|--|-------|
| Fuse Selection Chart | 6-7 |
| Fuseology | 8-9 |
| Retail Information, Packaging & Part Numbers | 10-12 |
| Blade Fuses | 13-15 |
| Cartridge Fuses | 16 |
| Bolt-Down Fuses | 17 |
| Auto Link Fuses | 18 |
| Glass Fuses | 19 |
| Specialty Fuse Products | 20 |
| Fuse Assortment Kits | 21-26 |
| Circuit Breakers | 27-30 |



Fuse Blocks & Holders

| | |
|-------------------------------|-------|
| Bolt-Down Fuse Blocks | 32 |
| In-line Fuse Holders | 33-34 |
| JCASE & Glass Fuse Holders | 35 |
| Add-A-Circuit & Power Feed | 36 |
| Fuse Puller Accessories | 37 |
| Multiple Position Fuse Blocks | 38-39 |
| Terminal Blocks | 40-41 |
| New Product Spotlight | 42 |



Power Distribution Modules

| | |
|----------------------------|-------|
| Hard-Wired Boxes | 44 |
| Power Distribution Modules | 44-47 |
| PDM IP Rating Flyer | 48 |



Battery Management

| | |
|-------------------------------------|----|
| Battery Isolators | 50 |
| Battery Combiners & FlexMod Devices | 51 |
| Low Voltage Disconnects | 51 |
| How a Smart Battery Isolator Works | 52 |



Relays & Solenoids

| | |
|--|-------|
| Bi-Stable Relays | 54 |
| Standard High Current Relays (Solenoids) | 55-57 |
| Reversing & Latching Relays | 58 |
| Plug-In Relays & MicroRelays | 59-60 |



Battery & Master Disconnect Switches

| | |
|---------------------------------------|-------|
| Sealed High Amp Battery Switches | 62 |
| Manual Battery Switches | 63-65 |
| Standard Metal Body Battery Switches | 66-67 |
| Marine-Grade Battery Switches | 68 |
| Battery Selector Disconnect Switches | 69 |
| Battery Disconnect Switch Accessories | 70 |



Ignition Switches

| | |
|-----------------------------------|-------|
| Sealed Ignition Switches | 72 |
| Heavy Duty Ignition Switches | 73 |
| General Purpose Ignition Switches | 74-75 |
| Marine Grade Ignition Switches | 76 |
| Ignition Switch Accessories | 77 |
| Anti-Restart Ignition Switches | 78 |



Rocker Switches

| | |
|-------------------------------------|-------|
| Sealed Rocker Switches | 80-83 |
| Rocker Switch Accessories | 84 |
| Standard Heavy Duty Rocker Switches | 85 |
| FAQ Rocker and Toggle Switches | 86 |



Toggle Switches

| | |
|-----------------------------------|-------|
| Toggle Switches | 88-91 |
| Toggle Switch Accessories | 92 |
| Switch Reference Guide & Diagrams | 93-94 |



Momentary Switches

| | |
|--------------------------------|--------|
| Momentary Push-Button Switches | 96-99 |
| Door Switches | 99-100 |



Push-Pull, Rotary & Foot Switches

| | |
|---------------------------------------|---------|
| Push-Pull Switches | 102-103 |
| Rotary Switches | 104 |
| Rotary Wiper Switches | 105-106 |
| Rotary Headlamp Switches | 107 |
| Foot Switches | 108 |
| Stoplamp Switches | 109 |
| Backup & Neutral Safety Ball Switches | 109-110 |



Vehicle Connectors

| | |
|--------------------------------|---------|
| Tractor-Trailer Connectors | 112-116 |
| Trailer Connectors | 117 |
| Connector Mounts & Accessories | 118 |



Indicator Devices

| | |
|------------------------------|---------|
| LED Pilot Lights | 120 |
| Incandescent Pilot Lights | 121-122 |
| Panel Lamps and Base Sockets | 122 |
| Buzzers and Alarms | 123 |
| Why are LED Lights Better | 124 |



Appendix

| | |
|--------------------------------|---------|
| Alphanumeric Part Number Index | 125-129 |
| Schematics | 130-131 |



Circuit Protection



What Type of Fuse do I Need?



DC (automotive) fuses are offered in two basic forms: Blade or Bolt Down.

Blade & Cartridge fuses can be hand inserted into a fuse holder. These fuses provide protection for several amperage ratings up to 80A. They are well suited to protect smaller to medium diameter wires that are usually some distance from the battery. Single blade fuse holders are often called 'In-Line' fuse holders as they are spliced into the wiring. Remember to place the fuse holder as close to the battery and as far away from the load as possible, so that it protects the wire from a short anywhere along its length. Any short between the power source and the fuse is not protected. Littelfuse blade fuses include: MICRO2®, MICRO3®, MINI®, LP MINI®, ATO®, MAXI®, MCASE+®, JCASE® and LP JCASE®.



Bolt Down fuses need to be secured to the fuse holder with a screw, nut or bolt. These fuses provide protection from 30A to 600A. They are well suited to protect medium to large diameter wires that are usually closer to the battery. Ring terminals are crimped onto cables that are connected to these holders and spliced into the wiring. Remember to place the fuse holder as close to the battery and as far away from the load as possible, so that it protects the wire from a short anywhere along its length. Any short between the power source and the fuse is not protected which is why you should have master fusing as close the battery as possible. Littelfuse bolt-down fuses include: MIDI®, MEGA®, CF8 and ZCASE®.

Also, there are still a wide variety of applications that use glass tube fuses. These are typically lower current values and are becoming less popular for most automotive applications due to their size, form factors, and lack of color coding.

It Glows When it Blows!



SmartGlow® fuse technology makes identifying an open circuit quick and easy. Inside a fuse box, it can be difficult to locate which fuse in an array has blown. You can easily identify the SmartGlow because it lights up, indicating the need for replacement. Available in MINI, ATO, and MAXI blade fuses.

Every Fuse Requires a Fuse Holder!

Littelfuse offers a wide variety of fuse holder and power distribution modules in different configurations to meet unique needs. Please see the Power Distribution Modules or Fuse Blocks & Holders sections of the catalog to select a product that fits your application requirements.



FUSE SELECTION CHART

| MICRO2® | MICRO3® | ATO® | MINI® | MCASE® | JCASE® | MAXI | MIDI® | MEGA® | PAL Series 0 | PAL Series 1 | PAL Series 2 | PAL Series 5 | ZCASE® |
|---------|---------|------|-------|--------|--------|------|-------|-------|--------------|--------------|--------------|--------------|--------|
| | | | | | | | | | | | | | |
| 1A | 2A | 3A | 3A | 3A | 3A | 3A | 3A | 3A | 3A | 3A | 3A | 3A | 3A |
| 2A | 3A | 4A | 4A | 4A | 4A | 4A | 4A | 4A | 4A | 4A | 4A | 4A | 4A |
| 5A | 5A | 5A | 5A | 5A | 5A | 5A | 5A | 5A | 5A | 5A | 5A | 5A | 5A |
| 7.5A | 7.5A | 7.5A | 7.5A | 7.5A | 7.5A | 7.5A | 7.5A | 7.5A | 7.5A | 7.5A | 7.5A | 7.5A | 7.5A |
| 10A | 10A | 10A | 10A | 10A | 10A | 10A | 10A | 10A | 10A | 10A | 10A | 10A | 10A |
| 15A | 15A | 15A | 15A | 15A | 15A | 15A | 15A | 15A | 15A | 15A | 15A | 15A | 15A |
| 20A | 20A | 20A | 20A | 20A | 20A | 20A | 20A | 20A | 20A | 20A | 20A | 20A | 20A |
| 25A | 25A | 25A | 25A | 25A | 25A | 25A | 25A | 25A | 25A | 25A | 25A | 25A | 25A |
| 30A | 30A | 30A | 30A | 30A | 30A | 30A | 30A | 30A | 30A | 30A | 30A | 30A | 30A |
| 40A | 40A | 40A | 40A | 40A | 40A | 40A | 40A | 40A | 40A | 40A | 40A | 40A | 40A |
| 50A | 50A | 50A | 50A | 50A | 50A | 50A | 50A | 50A | 50A | 50A | 50A | 50A | 50A |
| 60A | 60A | 60A | 60A | 60A | 60A | 60A | 60A | 60A | 60A | 60A | 60A | 60A | 60A |
| 75A | 75A | 75A | 75A | 75A | 75A | 75A | 75A | 75A | 75A | 75A | 75A | 75A | 75A |
| 80A | 80A | 80A | 80A | 80A | 80A | 80A | 80A | 80A | 80A | 80A | 80A | 80A | 80A |
| 100A | 100A | 100A | 100A | 100A | 100A | 100A | 100A | 100A | 100A | 100A | 100A | 100A | 100A |
| 125A | 125A | 125A | 125A | 125A | 125A | 125A | 125A | 125A | 125A | 125A | 125A | 125A | 125A |
| 150A | 150A | 150A | 150A | 150A | 150A | 150A | 150A | 150A | 150A | 150A | 150A | 150A | 150A |
| 175A | 175A | 175A | 175A | 175A | 175A | 175A | 175A | 175A | 175A | 175A | 175A | 175A | 175A |
| 200A | 200A | 200A | 200A | 200A | 200A | 200A | 200A | 200A | 200A | 200A | 200A | 200A | 200A |
| 225A | 225A | 225A | 225A | 225A | 225A | 225A | 225A | 225A | 225A | 225A | 225A | 225A | 225A |
| 250A | 250A | 250A | 250A | 250A | 250A | 250A | 250A | 250A | 250A | 250A | 250A | 250A | 250A |
| 275A | 275A | 275A | 275A | 275A | 275A | 275A | 275A | 275A | 275A | 275A | 275A | 275A | 275A |
| 300A | 300A | 300A | 300A | 300A | 300A | 300A | 300A | 300A | 300A | 300A | 300A | 300A | 300A |
| 325A | 325A | 325A | 325A | 325A | 325A | 325A | 325A | 325A | 325A | 325A | 325A | 325A | 325A |
| 350A | 350A | 350A | 350A | 350A | 350A | 350A | 350A | 350A | 350A | 350A | 350A | 350A | 350A |
| 375A | 375A | 375A | 375A | 375A | 375A | 375A | 375A | 375A | 375A | 375A | 375A | 375A | 375A |
| 400A | 400A | 400A | 400A | 400A | 400A | 400A | 400A | 400A | 400A | 400A | 400A | 400A | 400A |
| 425A | 425A | 425A | 425A | 425A | 425A | 425A | 425A | 425A | 425A | 425A | 425A | 425A | 425A |
| 450A | 450A | 450A | 450A | 450A | 450A | 450A | 450A | 450A | 450A | 450A | 450A | 450A | 450A |
| 475A | 475A | 475A | 475A | 475A | 475A | 475A | 475A | 475A | 475A | 475A | 475A | 475A | 475A |
| 500A | 500A | 500A | 500A | 500A | 500A | 500A | 500A | 500A | 500A | 500A | 500A | 500A | 500A |
| 525A | 525A | 525A | 525A | 525A | 525A | 525A | 525A | 525A | 525A | 525A | 525A | 525A | 525A |
| 550A | 550A | 550A | 550A | 550A | 550A | 550A | 550A | 550A | 550A | 550A | 550A | 550A | 550A |
| 575A | 575A | 575A | 575A | 575A | 575A | 575A | 575A | 575A | 575A | 575A | 575A | 575A | 575A |
| 600A | 600A | 600A | 600A | 600A | 600A | 600A | 600A | 600A | 600A | 600A | 600A | 600A | 600A |

GLASS

AGU

AGY, SFE30

AGX

AGW, SFE7.5, SFE9

SFE6

SFE14

AGC, SFE20, UK

AGA, SFE4

AGC
 .5A, 1A, 1.5A, 2A, 2.5A, 3A, 4A, 5A, 6A, 7.5A, 8A, 10A, 15A, 20A, 25A, 30A, 35A

AGU
 1A, 2A, 3A, 4A, 5A, 10A, 15A, 20A, 25A, 30A, 35A, 40A, 50A, 60A

AGW
 1A, 1.5A, 2A, 2.5A, 3A, 4A, 5A, 6A, 7.5A, 8A, 10A, 15A, 20A, 25A, 30A, 35A

AGX
 2A, 3A, 3A, 4A, 20A, 25A, 25A, 30A

AGY
 50A

SFE
 4A, 6A, 7.5A, 9A, 14A, 20A, 30A

UK
 35A, 50A



FUSE HOLDER SELECTION CHART

| FUSE TYPE | ATO® | | | | MINI® | | | MAXI | | GLASS | |
|------------------|---|---|---|--|---|---|---|---|--|--|--|
| ACTUAL FUSE SIZE |  | | | |  | | |  | |  | |
| PHOTO |  |  |  |  |  |  |  |  |  |  | |
| Series Name | FHA1 | FHA2 | FHA-GLO | AFH1 | FHM1 | FHM2 | FHM-GLO | MAH1 | FNY1 | FNY2 | |
| Holder Type | In-Line | In-Line | In-Line | In-Line Panel Mount | In-Line | In-Line | In-Line | In-Line | In-Line | In-Line | |
| Max Amperage | 20A | 30A | 30A | 20A | 20A | 30A | 30A | 60A | 20A | 30A | |
| Wire Color | Black | Orange | Red | Black | Black | Orange | Red | Black or Red | Black | Orange | |
| Weatherproof | • | • | • | | • | • | • | • | • | • | |
| Notes | Standard | Heavy Duty | Smart-Glow | Standard | Standard | Heavy Duty | Smart-Glow | Standard | Standard | Heavy Duty | |
| FUSE TYPE | JCASE® and Low Profile JCASE® | | | | | | | | | | |
| ACTUAL FUSE SIZE |  | | | | | | | | | | |
| PHOTO |  |  |  |  |  |  |  |  |  | | |
| Series Name | FHJC1 | FHJC2 | FHJ1 | Compact-498 | SN-MIDI | FLEX-MIDI | 298 | SN-MEGA | FLEX-MEGA | | |
| Holder Type | In-Line | In-Line | In-Line | In-Line | Bolt-Down | Bolt-Down | Bolt-Down | Bolt-Down | Bolt-Down | | |
| Max Amperage | 40A | 60A | 40A | 200A | 200A | 200A | 500A | 500A | 500A | | |
| Wire Color | Red | Red | Red | — | — | — | — | — | — | | |
| Weatherproof | • | • | | with heat shrink | • | | | • | | | |
| Notes | Standard | Heavy Duty | Standard | Compact | AssureLatch & IP69K | Busbars Available | Standard | AssureLatch & IP69K | Busbars Available | | |

Understanding how circuit protection works is a key to diagnosing automotive electrical problems. When a fuse blows, that means the fuse is doing its job — sending you a message that something needs to be fixed.

WHAT IS THE PURPOSE OF A FUSE?

A fuse is a safety valve. It is designed to stop current from exceeding the rating of the wires or components. Without fuses, excessive current could cause damage to electrical systems, and even result in fires.

In general, a fuse has a simple construction. The key component is the “element” — a short piece of metal wire or strap.

WHAT CAUSES A FUSE TO BLOW?

The element is designed to melt at a specific temperature, to protect wires and equipment from overcurrents. An overcurrent is any current that exceeds the amperage rating or wiring capacity of equipment or devices under normal conditions of use.



If an overcurrent causes the current in a circuit to rise above a specific level — often the circuit’s rating — the heat produced will melt the fuse’s element, causing the fuse to “blow.” This opens the circuit and immediately stops the flow of current. Fuses are designed to blow at temperatures far below those that would cause damage or hazards.

Once a fuse is blown, it can be replaced to allow the current to flow again. **But simply replacing a fuse may not be the solution to the problem.** In fact, there is a chance the fuse will just blow again, because the fuse is signaling a problem in the system. Understanding the factors that cause a fuse to blow will help you diagnose automotive electrical problems.

There are two types of overcurrents that can cause a fuse to blow: overloads and short circuits.

Overload

What: The current exceeds the amperage at which the wires or equipment are rated.

Why: Too many devices are connected to one circuit, or a device malfunctions and draws higher than its normal operating current. Sustained overloads cause overheating of circuit components and the fuse blows.

Short Circuit

What: The current is out of its normal path.

Why: A malfunction creates an unintended path for electricity to flow from the battery or alternator to ground. This can be caused by the touching of any positive wire to a ground wire, e.g. due to frayed wire insulation, or tools laid across the positive and ground wires of a circuit. The uncontrolled current to ground then surpasses the normal resistance of the wire contained in the circuit, forcing higher and higher current to the point of the generating heat which blows the fuse.



Bold letter indicates fuse block location.

- | | |
|--------------------------|--|
| A Left fire wall | G Behind/under dash left |
| B Right fire wall | H Behind/in glove box |
| C Right fender | J Behind/under dash right |
| D Right front | K Rear compartment |
| E Left front | IL In-line with device protected |
| F Left fender | (locations may vary from car to car, see your dealer.) |

FINDING A FUSE

To be able to address fuse issues, you first must be able to locate the appropriate fuse within the vehicle. In today’s vehicles, each individual wire is protected by a circuit protection device.

Fuses are contained in fuse blocks located at various points throughout the vehicle. The diagram above illustrates typical fuse block locations.

SELECTING THE RIGHT FUSE

Once you have found the fuse that has blown, and solved the problem in the vehicle, you must replace the blown fuse with an appropriate device.

When selecting the right fuse for replacement, you should consider the following:

Physical Type

The replacement fuse must be of the same physical type as the blown fuse being replaced. It must be of the same style and have the same dimensions so that it can fit properly in the fuse block or fuse holder. Check your owner’s manual to determine the appropriate fuse type.

Installation Tip: Littelfuse holds patents for the designs on most automotive fuses. It is important to remember that the physical type of the fuse is important, but it is not the only factor affecting the fuse’s function. Although some fuses appear to be the same type and dimension as Littelfuse fuses, they do not necessarily have the same performance characteristics.

Look for the Littelfuse OEM Label

To guarantee the same level of quality in circuit protection that the major automotive manufacturers require for their original equipment fuses, look for the OEM seal on Littelfuse aftermarket products. Only Littelfuse products can guarantee this level of quality.



Fuseology

1

Beware of Counterfeit Fuses

At first glance, it's hard to tell the difference between a genuine Littelfuse blade fuse and a counterfeit. The counterfeit may have the same physical dimensions, but using it can be dangerous because it fails to perform to the stringent performance and safety specifications developed by Littelfuse and the OEMs.

In many cases, the elements in counterfeit fuses do not correspond with the amperage specification stamped on the fuse. This will prevent the elements from opening at the rated or correct amperage, which could result in a fire causing serious damage to the vehicle, its contents and its passengers.

Responding to this growing problem, the United States International Trade Commission and then President Ronald Reagan issued and approved an exclusion order in 1983 prohibiting the importation of the look-alike blade fuses into the United States. This order was initiated because many of these fuses were proven to be totally unsafe. The photos shown here indicate why counterfeit fuses are potentially unsafe and present a fire risk.

To guarantee quality and safety, look for the Littelfuse name on fuses and fuse packaging.



Current Rating – Amperage

The current rating, marked on every fuse, is the maximum current in amperes that the fuse can continuously carry under specified conditions.



Tip: When selecting a fuse, make sure the current rating of the fuse is the same amperage as the circuit. You can obtain the current rating of a circuit by looking in the owner's manual of the vehicle or checking to see if it is written on the fuse block.

Overfusing and Underfusing

Overfusing is when the fuse has a current rating higher than the rating of the circuit. In this case, the fuse will not be able to protect the circuit properly because the circuit could reach overcurrent levels, causing damage and safety hazards, before the fuse would blow.

Underfusing is when the fuse is rated at a current too far below the rating of the circuit. In this case the fuse will blow, even though the circuit is functioning normally without an overcurrent. Underfusing almost guarantees that a fuse will blow repeatedly. This is referred to as a nuisance blow.

Voltage Rating

The voltage rating, marked on every fuse, indicates the maximum voltage at which the fuse is designed to operate safely if an overcurrent occurs.

Tip: The fuse voltage rating must equal or exceed this circuit voltage where the fuse is installed. This is not a problem in fuse selection because automotive fuse applications are typically around 12 volts, while the voltage rating of the majority of Littelfuse automotive fuses including ATO Fuse, MINI Fuse, MAXI Fuse and MEGA Fuse is 32 volts.



ADDING A CIRCUIT

Always use a circuit protection device with a fuse holder or fuse block whenever adding additional circuits to ensure optimal safety. The fastest, easiest option for installers who need to add a circuit for applications such as electronic components, is the Littelfuse Add-A-Circuit Fuse Holder. Add-A-Circuit, available in ATO® and MINI® blade fuse versions, is designed to facilitate installation of fuses for accessories of 10 amps or less. The Add-A-Circuit adapts the fuse block to the installer's needs, quickly turning one slot in the fuse block into two, providing a safe, economical alternative to splicing or fusetaps.

Caution: Fusetaps are not a recommended alternative for adding circuits because they can overstress the terminals in the fuse block. This situation can create a loose fitting fuse, which in turn produces excessive heat, which can cause nuisance blows, even melting of the fuse and fuse block and possibly an expensive repair in the future. When a fusetap is used, in many cases there is no fuse protecting the new circuit, a condition which can also present a hazard.

Another alternative to adding a circuit is the Littelfuse Battery Power Feed (BPF1). This device attaches directly to the battery terminal, allowing the addition of up to three circuits. Then use an in-line fuse holder to protect the circuit properly.



Retail Information



Planogram

Updated brand packaging introduced in 2015 allowing for easy identification of product families in a retail display.

Littelfuse developed the next generation of Retail Circuit Protection with the ease of product selection as a top priority.

EASY IDENTIFICATION

of product families in color coordinated packages for an easy to use and set up planogram layout.

MORE SPACE

for higher margin kits and assortments.

INCREASE MARKET COVERAGE

with the newest Littelfuse MICRO2®, MICRO3®, MCASE+® and ZCASE® fuses.

**ORIGINAL
EQUIPMENT
MANUFACTURER**

OEM SYMBOL

Prominent on package assures consumers of quality and actual OE replacement.

COLOR CODED

for easier stocking and consumer selection.

MULTI-LINGUAL

One SKU covers US, Canadian, German and Latin American markets.

| MATERIAL NUMBER | CATALOG NUMBER | DESCRIPTION |
|-----------------|----------------|--|
| 00940477Z | 094477 | Our 87 SKU, 510-piece pre-pack Plan-O-Gram includes full blade-fuse coverage, as well as expanded coverage into newer parts such as Low-Profile MINI, Low-Profile JCASE, MICRO2, MICRO3, MCASE and Emergency Kits. Includes blade fuses, glass fuses, circuit breakers, Assortment and Emergency kits, fuse holders and fuse tester/pullers. Measures approximately 36"x36". |
| 00940478Z | 094478 | Our 103 SKU, 625-piece pre-pack Plan-O-Gram is our largest retail assortment featuring multiple facings of the most popular items. This assortment expands your line coverage to fill the needs of your DIY and professional dealer/installer customers as well. Measures approximately 48"x32". |

Retail Information

Packaging / Part Numbering

1

Bulk Carton

The outer corrugated cardboard box that holds several cartons.



Carton

The outer corrugated cardboard box that holds several inner packs, or bulk fuses (no inner packs).

Blister Pack

A retail package containing one or several identical products, such as fuses, or it may contain an assortment of fuses. Blister packs are designed to fit on a peg-hook. 'Bubble pack' or 'clamshell' packages are blister packs.

Inner Pack

A small chipboard box containing several blister packs or pillboxes.

Pill Box

A small plastic box containing fuses. Pillboxes are snap-shut resealable.

Fuse Packaging

Standard Fuse Packaging

| BOXED MERCHANDISE | PIECES/BOX | STANDARD PACK | ORDER |
|---|-------------|----------------------|----------|
| ATO, MINI Fuses | 5 to a box | 100 (twenty 5 packs) | by piece |
| Glass Ceramic Fuses | 5 to a box | 50 (ten 5 packs) | by piece |
| AGU Fuses | 10 to a box | 10 (one 10 pack) | by piece |
| MAXI, PAL, MEGA, MIDI | 1 to a pack | 10 | by piece |
| Flashers, Circuit Breakers, Fuse Holders | 1 to a pack | 10 | by piece |
| RETAIL PACKAGED MERCHANDISE | FUSES/CARD | STANDARD PACK | ORDER |
| ATO, MINI Fuses, Glass, Ceramic Fuses | 5 to a card | 5 cards/shelf pack | by card |
| MAXI, PAL, MEGA, MIDI Fuses | 1 to a card | 5 cards/shelf pack | by card |
| Plus Packs | 25 | 5 cards/shelf pack | by card |
| Retail Carded Kits and Assortments | Various | 5 cards/shelf pack | by card |
| Assortments, Jobber Boards, Merchandisers, etc. | Various | Single unit | by unit |

Examples of Order Numbers

Order numbers must have between 9 characters and 15 characters. These are for added description, such as ZXPRO. When you place an order, write or type the characters without a break in the string.

0ATO 010. VP

First set of four
"ATO Fuses"

Second set of four
"10 Amps"

"Retail pack of 5"

0MIN 030. ZXPRO

First set of four
"MINI Fuses"

Second set of four
"30 Amps"

"Professional Pack"

Mandatory Characters

First set of four

These identify the product group, like LMIN (Low profile MINI fuse) or OMAX (MAXI fuses).

Second set of four

These identify the product subgroup. In fuses, this usually identifies the amperage.

The decimal point counts as one character, eg 010. = 10A, 100. = 100A, 01.5 = 1.5A.

9th character

Inner pack quantity. See list of codes below.

Inner Pack Codes

Quantity Code

| | |
|---------|------------|
| 1 = X | 500 = U |
| 5 = V | 1,000 = M |
| 10 = T | 1,500 = D |
| 20 = S | 2,500 = E |
| 50 = L | 3,000 = W |
| 100 = H | 4,000 = Y |
| 200 = F | 5,000 = N |
| 250 = G | 10,000 = K |

Optional Characters

10th Character

Packaging type. P= Retail pack, B=Blister Pack.

Last set of 5

May be used to give additional information such as, MXGLO for SmartGlow fuses

Blade Fuses

1



MINI® • 2-30A • Standard and Smart Glow Blade Fuses

The MINI fuse is quickly becoming the new standard for vehicle circuit protection. Its miniature design meets the need for more circuits to be protected while utilizing less space, and its ability to cope with high temperatures in adverse environments makes the MINI fuse the recommended choice for protection. Smart Glow fuses are innovative automotive style fuses that feature an indicator light that glows when the fuse is blown, saving time to troubleshoot an open circuit.

Additional information: littelfuse.com/MINI

Standard: Voltage Rating Characteristics: 32V AC/DC Fast-Acting, Approvals: UL listed, SAE J2077.

Smart Glow: Interrupting Rating: 1000A @ 32V DC, Voltage Rating: 32V DC, Operating Temperature Range: -40°C to +125°C, Terminals: Tin plated zinc



SMART GLOW Fuses

| COLOR CODE | CURRENT RATING (A) | BOXED | CARDED | CARDED PLUS PACK | CARDED |
|------------|--------------------|-----------------|---------------------------|---------------------------|---------------------------|
| | | MATERIAL NUMBER | PACKAGING MATERIAL NUMBER | PACKAGING MATERIAL NUMBER | PACKAGING MATERIAL NUMBER |
| Gray | 2 | OMIN002.V | OMIN002.VP | — | — |
| Violet | 3 | OMIN003.V | OMIN003.VP | — | OMIN003.VPGLO |
| Pink | 4 | OMIN004.V | OMIN004.VP | — | — |
| Tan | 5 | OMIN005.V | OMIN005.VP | — | OMIN005.VPGLO |
| Brown | 7.5 | OMIN07.5V | OMIN07.5VP | — | OMIN07.5VPGLO |
| Red | 10 | OMIN010.V | OMIN010.VP | OMIN010.ZXPRO | OMIN010.VPGLO |
| Blue | 15 | OMIN015.V | OMIN015.VP | OMIN015.ZXPRO | OMIN015.VPGLO |
| Yellow | 20 | OMIN020.V | OMIN020.VP | OMIN020.ZXPRO | OMIN020.VPGLO |
| Clear | 25 | OMIN025.V | OMIN025.VP | OMIN025.ZXPRO | OMIN025.VPGLO |
| Green | 30 | OMIN030.V | OMIN030.VP | OMIN030.ZXPRO | OMIN030.VPGLO |

Dimensions MINI®



Dimensions SMART GLOW MINI®



Low Profile MINI® • 2-30A • Blade Fuses

The Low Profile MINI fuse is designed to mate with tuning-fork terminals, which provides additional weight and material savings in fuse box designs by eliminating the need for female box terminals.

Additional information: littelfuse.com/LPMINI

Voltage Rating: 58V DC, Interrupting Rating: 1000A @ 58V DC, Operating Temperature Range: -40°C to +125°C, Terminals: Silver plated zinc, Housing Materials: Nylon composite



| COLOR CODE | CURRENT RATING (A) | BOXED | CARDED | CARDED PLUS PACK |
|------------|--------------------|-----------------|---------------------------|---------------------------|
| | | MATERIAL NUMBER | PACKAGING MATERIAL NUMBER | PACKAGING MATERIAL NUMBER |
| Gray | 2 | LMIN002.V | — | — |
| Tan | 5 | LMIN005.V | LMIN005.VP | LMIN005.ZXPROA |
| Brown | 7.5 | LMIN07.5V | — | — |
| Red | 10 | LMIN010.V | LMIN010.VP | LMIN010.ZXPROA |
| Blue | 15 | LMIN015.V | LMIN015.VP | LMIN015.ZXPROA |
| Yellow | 20 | LMIN020.V | LMIN020.VP | LMIN020.ZXPROA |
| Clear | 25 | LMIN025.V | LMIN025.VP | LMIN025.ZXPROA |
| Green | 30 | LMIN030.V | LMIN030.VP | LMIN030.ZXPROA |

Dimensions Low Profile MINI®



Blade Fuses

ATO® • Autofuse® • 1-40A • Standard and Smart Glow Blade Fuses

The ATO fuse is currently found on most cars, trucks, buses and off the road vehicles worldwide. Features Littelfuse designed industry standard color coding to indicate amp rating. Smart Glow fuses are innovative automotive style fuses that feature an indicator light that glows when the fuse is blown, saving time to troubleshoot an open circuit. Additional information: littelfuse.com/ATO

Standard: Voltage Rating Characteristics: 32V AC/DC Fast-Acting Approvals: UL listed, SAE J2077.

Smart Glow: Interrupting Rating: 1000A @ 32V DC Voltage Rating: 32V DC Operating Temperature Range: -40°C to +125°C Terminals: Tin plated zinc



| COLOR CODE | CURRENT RATING (A) | BOXED | CARDED | CARDED PLUS PACK | CARDED |
|------------|--------------------|-----------------|---------------------------|---------------------------|---------------------------|
| | | MATERIAL NUMBER | PACKAGING MATERIAL NUMBER | PACKAGING MATERIAL NUMBER | PACKAGING MATERIAL NUMBER |
| Black | 1 | OATO001.V | OATO001.VP | - | - |
| Gray | 2 | OATO002.V | OATO002.VP | - | - |
| Violet | 3 | OATO003.V | OATO003.VP | - | OATO003.VPGLO |
| Pink | 4 | OATO004.V | OATO004.VP | - | - |
| Tan | 5 | OATO005.V | OATO005.VP | OATO005.ZXPRO | OATO005.VPGLO |
| Brown | 7.5 | OATO007.5V | OATO007.5VP | OATO007.5ZXPRO | OATO007.5VPGLO |
| Red | 10 | OATO010.V | OATO010.VP | OATO010.ZXPRO | OATO010.VPGLO |
| Blue | 15 | OATO015.V | OATO015.VP | OATO015.ZXPRO | OATO015.VPGLO |
| Yellow | 20 | OATO020.V | OATO020.VP | OATO020.ZXPRO | OATO020.VPGLO |
| Clear | 25 | OATO025.V | OATO025.VP | OATO025.ZXPRO | OATO025.VPGLO |
| Green | 30 | OATO030.V | OATO030.VP | OATO030.ZXPRO | OATO030.VPGLO |
| Orange | 40 | OATO040.V | OATO040.VP | - | - |

Dimensions ATO®

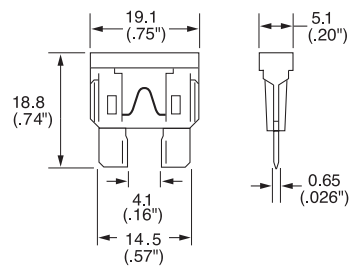

Dimensions SMART GLOW ATO®

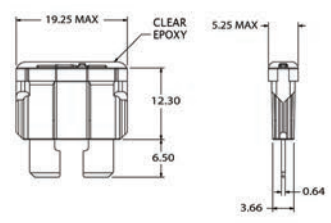

MAXI • 20-100A • Standard and Smart Glow Blade Fuses

MAXI Fuses are primarily used for under hood applications and are produced with a high temperature polymer and silver plated blades. They replace the commonly used fusible wire or fusible link to protect a high current segment or system of the wiring harness. Features Littelfuse designed industry standard color coding to indicate amp rating. Smart Glow fuses are innovative automotive style fuses that feature an indicator light that glows when the fuse is blown, saving time to troubleshoot an open circuit.

Additional information: littelfuse.com/MAXI

Standard: Voltage Rating: 32V DC, Interrupting Ratings: 1000A @ 32V DC, Operating Temperature Range: -40°C to +125°C, Terminals: Silver plated

Smart Glow: Voltage Rating: 32V DC, Interrupting Ratings: 1000A @ 32V DC, Operating Temperature Range: -40°C to +125°C, Terminals: Silver plated



| COLOR CODE | CURRENT RATING (A) | BOXED | CARDED | CARDED |
|------------|--------------------|-----------------|---------------------------|---------------------------|
| | | MATERIAL NUMBER | PACKAGING MATERIAL NUMBER | PACKAGING MATERIAL NUMBER |
| Yellow | 20 | OMAX020.X | OMAX020.XP | OMAX020.XPGLO |
| Green | 30 | OMAX030.X | OMAX030.XP | OMAX030.XPGLO |
| Orange | 40 | OMAX040.X | OMAX040.XP | OMAX040.XPGLO |
| Red | 50 | OMAX050.X | OMAX050.XP | OMAX050.XPGLO |
| Blue | 60 | OMAX060.X | OMAX060.XP | OMAX060.XPGLO |
| Tan | 70 | OMAX070.X | - | OMAX070.XPGLO |
| Clear | 80 | OMAX080.X | OMAX080.XP | OMAX080.XPGLO |
| Purple | 100 | - | - | OMAX100.XPGLO |

Dimensions MAXI

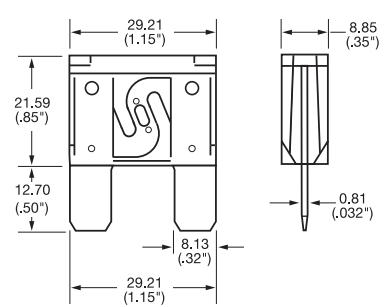

Blade Fuses

1



MICRO2® • 5-30A • Blade Fuses

Its sub-miniature design meets the need for more circuits to be protected while utilizing less space and its ability to cope with high temperatures in adverse environments makes the MICRO2 Fuse the recommended choice for protection.

Additional information: littelfuse.com/MICRO2

Voltage Rating: 32V DC, Interrupting Ratings: 1000A @ 32V DC, Operating Temperature Range: -40°C to +125°C

| COLOR CODE | CURRENT RATING (A) | BULK 50-PC | BOXED 25-PC | BOXED 5-PC | CARDED 5-PC |
|------------|--------------------|-----------------|-----------------|-----------------|-----------------|
| | | MATERIAL NUMBER | MATERIAL NUMBER | MATERIAL NUMBER | MATERIAL NUMBER |
| Tan | 5 | 0327005.LXS | – | MIC2005.V | MIC2005.VP |
| Brown | 7.5 | 032707.5LXS | – | MIC207.5V | MIC207.5VP |
| Red | 10 | 0327010.LXS | MIC2010.ZXPRO | MIC2010.V | MIC2010.VP |
| Blue | 15 | 0327015.LXS | MIC2015.ZXPRO | MIC2015.V | MIC2015.VP |
| Yellow | 20 | 0327020.LXS | MIC2020.ZXPRO | MIC2020.V | MIC2020.VP |
| Clear | 25 | 0327025.LXS | – | MIC2025.V | MIC2025.VP |
| Green | 30 | 0327030.LXS | MIC2030.ZXPRO | MIC2030.V | MIC2030.VP |

Dimensions MICRO2®

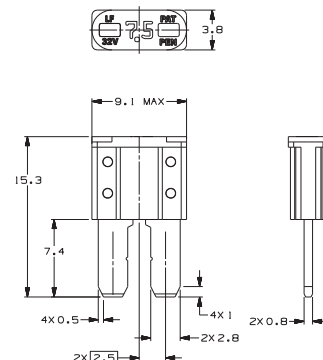

MICRO3® • 5-15A • Blade Fuses

The MICRO3 Fuse is the new standard for vehicle circuit protection. The MICRO3 Fuse has 3 terminals and 2 fuse elements with a common center terminal. Its sub-miniature design meets the need for more circuits to be protected while utilizing less space and its ability to cope with high temperatures in adverse environments makes the MICRO3 Fuse the recommended choice for protection.

Additional information: littelfuse.com/MICRO3

Voltage Rating: 32V DC, Interrupting Ratings: 1000A @ 32V DC, Operating Temperature Range: -40°C to +125°C

| COLOR CODE | CURRENT RATING (A) | BULK 50-PC | BOXED 25-PC | BOXED 5-PC | CARDED 5-PC |
|------------|--------------------|-----------------|-----------------|-----------------|-----------------|
| | | MATERIAL NUMBER | MATERIAL NUMBER | MATERIAL NUMBER | MATERIAL NUMBER |
| Tan | 5 | 0337005.LXS | MIC3005.ZXPRO | MIC3005.V | MIC3005.VP |
| Brown | 7.5 | 033707.5LXS | MIC307.5ZXPRO | MIC307.5V | MIC307.5VP |
| Red | 10 | 0337010.LXS | MIC3010.ZXPRO | MIC3010.V | MIC3010.VP |
| Blue | 15 | 0337015.LXS | MIC3015.ZXPRO | MIC3015.V | MIC3015.VP |

Dimensions MICRO3®

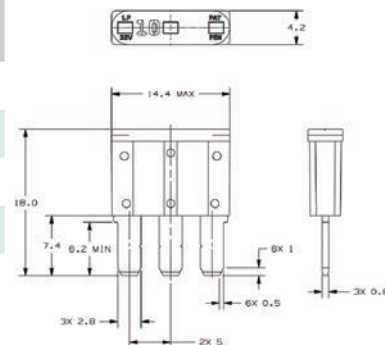

Cartridge Fuses



JCASE® • 20-60A • Cartridge Fuses

Smaller space saving footprint is being designed in by many OEM's. Patented technology provides both increased time delay and low voltage drop. Features ANSI standard OCR-A font for visual inspection systems, double spring-beam box terminal and unique secondary locking feature holds terminal firmly in place. Additional information: littelfuse.com/JCASE

Voltage Rating Characteristics: 32V AC/DC Slo-Blo®, Interrupting Ratings: 1000A @ 32V DC, Operating Temperature Range: -40°C to +125°C, Insertion Force: 53N max. (12lb), Extraction Force: 9N min. (2lb)

| COLOR CODE | CURRENT RATING (A) | BOXED | CARDED |
|------------|--------------------|-----------------|---------------------------|
| | | MATERIAL NUMBER | PACKAGING MATERIAL NUMBER |
| Blue | 20 | JCAS020.X | JCAS020.XP |
| White | 25 | JCAS025.X | JCAS025.XP |
| Pink | 30 | JCAS030.X | JCAS030.XP |
| Green | 40 | JCAS040.X | JCAS040.XP |
| Red | 50 | JCAS050.X | JCAS050.XP |
| Yellow | 60 | JCAS060.X | JCAS060.XP |

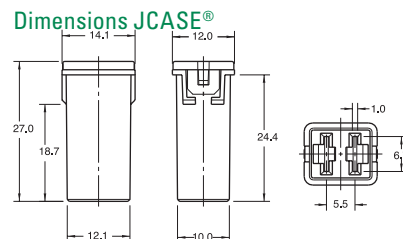

Low Profile JCASE® • 20-60A • Cartridge Fuses

Smaller space saving footprint is being designed in by many OEM's. Patented technology provides both increased time delay and low voltage drop. Features ANSI standard OCR-A font for visual inspection systems, double spring-beam box terminal and unique secondary locking feature holds terminal firmly in place. Additional information: littelfuse.com/LPJCASE

Voltage Rating: 58V DC, Interrupting Rating: 1000A @ 58V DC, Operating Temperature Range: -40°C to +125°C, Insertion Force: 53N Max. (12 lb.), Extraction Force: 9N Min (2 lb.)

| COLOR CODE | CURRENT RATING (A) | BOXED | CARDED |
|------------|--------------------|-----------------|---------------------------|
| | | MATERIAL NUMBER | PACKAGING MATERIAL NUMBER |
| Blue | 20 | LJCA020.X | LJCA020.XP |
| White | 25 | LJCA025.X | LJCA025.XPA |
| Pink | 30 | LJCA030.X | LJCA030.XP |
| Green | 40 | LJCA040.X | LJCA040.XP |
| Red | 50 | LJCA050.X | LJCA050.XP |
| Yellow | 60 | LJCA060.X | LJCA060.XP |

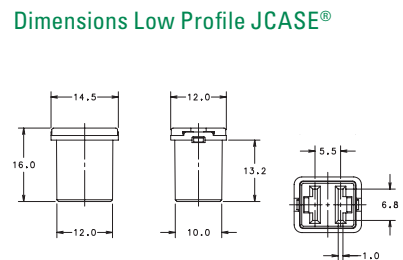

MCASE+® • 15-60A • Cartridge Fuses

The Unslotted MCASE+ Fuse is a cartridge style fuse up to 40A with female terminals for 2.8 mm male terminals. The Slotted MCASE+ Fuse is available up to 60A and can mate with larger male terminals (e.g., 6.3mm) or even mount directly to onto a busbar. Miniaturized footprint for optimal usage of space, featuring time delay and the ability to handle inrush currents. Additional information: littelfuse.com/MCASE

Voltage Rating: 32V DC, Interrupting Ratings: 1000A @ 32V DC, Operating Temperature Range: -40°C to +125°C Fuse Insertion Force: 50N (11.2lb) Typical, Extraction Force: 4N Min. (0.9 lb.) | 24.5N Max. (5.5 lb)

| | COLOR CODE | CURRENT RATING (A) | BULK 500-PC | BOXED 50-PC | BOXED 5-PC | CARDED 1-PC |
|-----------|------------|--------------------|-----------------|-----------------|-----------------|-----------------|
| | | | MATERIAL NUMBER | MATERIAL NUMBER | MATERIAL NUMBER | MATERIAL NUMBER |
| UNSLOTTED | Gray | 15 | 0695015.U | 0695015.LPXP | MCAS015.V | MCAS015.XP |
| | Blue | 20 | 0695020.U | 0695020.LPXP | MCAS020.V | MCAS020.XP |
| | White | 25 | 0695025.U | 0695025.LPXP | MCAS025.V | MCAS025.XP |
| | Pink | 30 | 0695030.U | 0695030.LPXP | MCAS030.V | MCAS030.XP |
| | Green | 40 | 0695040.U | 0695040.LPXP | MCAS040.V | MCAS040.XP |
| SLOTTED | COLOR CODE | CURRENT RATING (A) | BULK 500-PC | BOXED 50-PC | BOXED 5-PC | CARDED 1-PC |
| | | | MATERIAL NUMBER | MATERIAL NUMBER | MATERIAL NUMBER | MATERIAL NUMBER |
| | Gray | 15 | 0695015.US | 0695015.LPXPS | MCAS015.VS | MCAS015.XPS |
| | Blue | 20 | 0695020.US | 0695020.LPXPS | MCAS020.VS | MCAS020.XPS |
| | White | 25 | 0695025.US | 0695025.LPXPS | MCAS025.VS | MCAS025.XPS |
| | Pink | 30 | 0695030.US | 0695030.LPXPS | MCAS030.VS | MCAS030.XPS |
| | Green | 40 | 0695040.US | 0695040.LPXPS | MCAS040.VS | MCAS040.XPS |
| Red | 50 | 0695050.US | 0695050.LPXPS | MCAS050.VS | MCAS050.XPS | |
| Yellow | 60 | 0695060.US | 0695060.LPXPS | MCAS060.VS | MCAS060.XPS | |

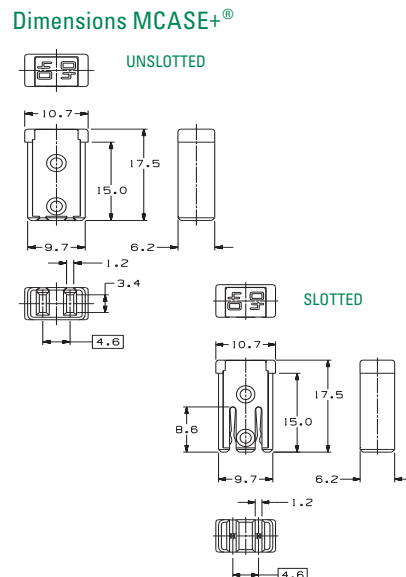

* Please inquire about additional bulk quantities

Bolt-Down Fuses

MEGA® • 80-500A • Bolt-Down Fuses

Littelfuse patented fuse designed for high current protection up to 500A found on many OEM vehicles. Slo-Blo® feature eliminates nuisance blowing during temporary, short duration overloads. Commonly used for battery and alternator connections and other heavy gauge cables requiring ultra high current protection. Also available with a clear housing, M6 mounting hole, single mounting hole or silver plating. For details, contact Littelfuse or visit: littelfuse.com/MEGA
Voltage Rating Characteristics: 32V AC/DC, Slo-Blo®

| CURRENT RATING (A) | BOXED 50-PC | BOXED 1-PC | CARDED |
|--------------------|-----------------|-----------------|-----------------|
| | MATERIAL NUMBER | MATERIAL NUMBER | MATERIAL NUMBER |
| 80 | — | OMEG080.X | OMEG080.XPA |
| 100 | OMEG100.L | OMEG100.X | OMEG100.XP |
| 125 | OMEG125.L | OMEG125.X | OMEG125.XP |
| 150 | OMEG150.L | OMEG150.X | OMEG150.XP |
| 175 | OMEG175.L | OMEG175.X | OMEG175.XP |
| 200 | OMEG200.L | OMEG200.X | OMEG200.XP |
| 225 | OMEG225.L | OMEG225.X | OMEG225.XP |
| 250 | OMEG250.L | OMEG250.X | OMEG250.XP |
| 300 | OMEG300.L | OMEG300.X | — |
| 350 | OMEG350.L | OMEG350.X | — |
| 400 | OMEG400.L | OMEG400.X | — |
| 450 | OMEG450.L | OMEG450.X | — |
| 500 | OMEG500.L | OMEG500.X | — |

Dimensions MEGA®

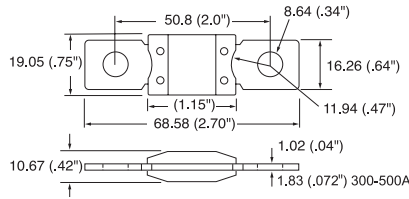

MIDI® • 30-200A • Bolt-Down Fuses

Littelfuse patented fuse found on many OEM vehicles. Slo-Blo® feature eliminates nuisance blowing during temporary, short duration overloads. Also available with a clear housing, M6 mounting hole, single mounting hole or silver plating. For details, contact Littelfuse or visit: littelfuse.com/MIDI
Voltage Rating Characteristics: 32V AC/DC, Slo-Blo®

| CURRENT RATING (A) | BULK 10-PC | BOXED | CARDED |
|--------------------|-----------------|-----------------|-----------------|
| | MATERIAL NUMBER | MATERIAL NUMBER | MATERIAL NUMBER |
| 30 | 0498030.TXN | — | — |
| 40 | 0498040.TXN | — | — |
| 50 | 0498050.TXN | OMID050.X | OMID050.XP |
| 60 | 0498060.TXN | — | — |
| 70 | 0498070.TXN | — | — |
| 80 | 0498080.TXN | OMID080.X | OMID080.XP |
| 100 | 0498100.TXN | — | — |
| 125 | 0498125.TXN | — | — |
| 150 | 0498150.TXN | — | OMID150.XP |
| 200 | 0498200.TXN | — | — |

Dimensions MIDI®

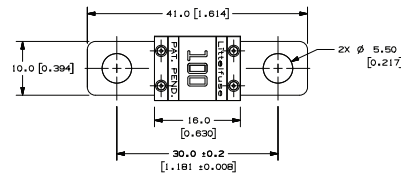

ZCASE® • 40-600A • Bolt-Down Fuses

Designed for a one bolt connection M6 (125-250A) or M8 (300-600A) and can be used directly on a battery post or busbar connection. Additional information: littelfuse.com/ZCASE
Voltage Rating Characteristics: 32V AC/DC, Slo-Blo®

| CURRENT RATING (A) | BULK 480-PC | BULK 100-PC | CARDED |
|--------------------|-----------------|-----------------|-----------------|
| | MATERIAL NUMBER | MATERIAL NUMBER | MATERIAL NUMBER |
| 40 | 3298040.Z | 3298040.H | — |
| 60 | 3298060.Z | 3298060.H | — |
| 80 | 3298080.Z | 3298080.H | ZCAS080.XP |
| 100 | 3298100.Z | 3298100.H | ZCAS100.XP |
| 125 | 3298125.Z | 3298125.H | ZCAS125.XP |
| 150 | 3298150.Z | 3298150.H | ZCAS150.XP |
| 175 | 3298175.Z | 3298175.H | ZCAS175.XP |
| 200 | 3298200.Z | 3298200.H | ZCAS200.XP |
| 225 | 3298225.Z | 3298225.H | ZCAS225.XP |
| 250 | 3298250.Z | 3298250.H | ZCAS250.XP |
| 300 | 3298300.ZXSTA | 3298300.H | ZCAS300.XP |
| 350 | 3298350.ZXSTA | 3298350.H | ZCAS350.XP |
| 400 | 3298400.ZXSTA | 3298400.H | ZCAS400.XP |
| 500 | 3298500.ZXSTA | 3298500.H | ZCAS500.XP |
| 600 | 3298600.ZXSTA | 3298600.H | — |

Dimensions ZCASE®

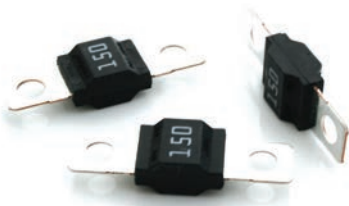
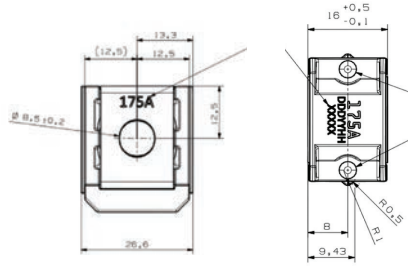

Auto Link Fuses



PAL Auto Link Fuses

Commonly found on many Japanese and Domestic built vehicles in current ratings up to 140 amperes. Available with female connector, male connector, bent connector and locking female connector. Color coded to indicate amp rating.

Additional information: littelfuse.com/PAL

PAL Female Terminal



| COLOR CODE | CURRENT RATING (A) | BOXED | CARDED |
|------------|--------------------|-----------------|---------------------------|
| | | MATERIAL NUMBER | PACKAGING MATERIAL NUMBER |
| Blue | 20 | OPAL020.X | OPAL020.XP |
| Pink | 30 | OPAL030.X | OPAL030.XP |
| Green | 40 | OPAL040.X | OPAL040.XP |
| Red | 50 | OPAL050.X | OPAL050.XP |
| Yellow | 60 | OPAL060.X | OPAL060.XP |



PAL MINI® Female Terminal

| COLOR CODE | CURRENT RATING (A) | BOXED | CARDED |
|------------|--------------------|-----------------|---------------------------|
| | | MATERIAL NUMBER | PACKAGING MATERIAL NUMBER |
| Pink | 30A | OPAL330.X | OPAL330.XP |
| Green | 40A | OPAL340.X | OPAL340.XP |



PAL Straight Male Terminal



| COLOR CODE | CURRENT RATING (A) | BOXED | CARDED |
|------------|--------------------|-----------------|---------------------------|
| | | MATERIAL NUMBER | PACKAGING MATERIAL NUMBER |
| Pink | 30 | OPAL130.X | OPAL130.XP |
| Yellow | 60 | OPAL160.X | OPAL160.XP |
| Black | 80 | OPAL180.X | OPAL180.XP |
| Blue | 100 | OPAL1100X | OPAL1100XP |
| Gray | 120 | OPAL1120X | OPAL1120XP |



PAL 9/16" Bent Male Terminal

| COLOR CODE | CURRENT RATING (A) | BOXED | CARDED |
|------------|--------------------|-----------------|---------------------------|
| | | MATERIAL NUMBER | PACKAGING MATERIAL NUMBER |
| Pink | 30 | OPAL430.X | OPAL430.XP |
| Green | 40 | OPAL440.X | OPAL440.XP |
| Red | 50 | OPAL450.X | OPAL450.XP |
| Black | 80 | OPAL480.X | OPAL480.XP |
| Blue | 100 | OPAL4100X | OPAL4100XP |
| White | 120 | – | OPAL4120XP |
| Purple | 140 | – | OPAL4140XP |



PAL 13/16" Bent Male Terminal

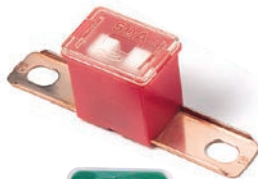

| COLOR CODE | CURRENT RATING (A) | BOXED | CARDED |
|------------|--------------------|-----------------|---------------------------|
| | | MATERIAL NUMBER | PACKAGING MATERIAL NUMBER |
| Pink | 30 | OPAL230.X | OPAL230.XP |
| Green | 40 | OPAL240.X | OPAL240.XP |
| Red | 50 | OPAL250.X | OPAL250.XP |
| Yellow | 60 | OPAL260.X | OPAL260.XP |
| Brown | 70 | OPAL270.X | OPAL270.XP |
| Black | 80 | OPAL280.X | OPAL280.XP |
| Blue | 100 | OPAL2100X | OPAL2100XP |
| Gray | 120 | OPAL2120X | OPAL2120XP |
| Purple | 140 | – | OPAL2140XP |



PAL Locking Female Terminal

| COLOR CODE | CURRENT RATING (A) | BOXED | CARDED |
|------------|--------------------|-----------------|---------------------------|
| | | MATERIAL NUMBER | PACKAGING MATERIAL NUMBER |
| Brown | 25 | OPAL525.X | OPAL525.XP |
| Green | 30 | OPAL530.X | OPAL530.XP |



Glass Fuses

1



AG • Glass Fuses

Originally stood for "all glass." The automotive industry uses the "AG" prefix (AGC, AGW) for most glass fuses. They vary in length, diameter and amperage rating.

Additional information: littelfuse.com/Glass

Voltage Rating: 32V AC/DC, 250V may be substituted

| CURRENT RATING (A) | BOXED | CARDED |
|--------------------|-----------------|---------------------------|
| | MATERIAL NUMBER | PACKAGING MATERIAL NUMBER |
| AGA (1AG) | | |
| 1 | 0AGA001.V | 0AGA001.VP |
| 2 | 0AGA002.V | 0AGA002.VP |
| 3 | 0AGA003.V | 0AGA003.VP |
| 5 | 0AGA005.V | 0AGA005.VP |
| 6 | 0AGA006.V | - |
| 7.5 | 0AGA007.5V | - |
| 10 | 0AGA010.V | 0AGA010.VP |
| 15 | 0AGA015.V | 0AGA015.VP |
| 20 | 0AGA020.V | 0AGA020.VP |
| 25 | 0AGA025.V | - |
| 30 | 0AGA030.V | 0AGA030.VP |
| AGW (7AG) | | |
| 1 | 0AGW001.V | - |
| 1.5 | 0AGW01.5V | - |
| 2.5 | 0AGW02.5V | - |
| 3 | 0AGW003.V | - |
| 4 | 0AGW004.V | - |
| 5 | 0AGW005.V | 0AGW005.VP |
| 6 | 0AGW006.V | - |
| 15 | 0AGW015.V | 0AGW015.VP |
| 20 | 0AGW020.V | 0AGW020.VP |
| 30 | 0AGW030.V | 0AGW030.VP |

| CURRENT RATING (A) | BOXED | CARDED |
|--------------------|-----------------|---------------------------|
| | MATERIAL NUMBER | PACKAGING MATERIAL NUMBER |
| AGC (3AG) | | |
| .5 | 0AGC.500V | - |
| 1 | 0AGC001.V | 0AGC001.VP |
| 1.5 | 0AGC01.5V | 0AGC01.5VP |
| 2 | 0AGC002.V | 0AGC002.VP |
| 2.5 | 0AGC02.5V | 0AGC02.5VP |
| 3 | 0AGC003.V | 0AGC003.VP |
| 4 | 0AGC004.V | 0AGC004.VP |
| 5 | 0AGC005.V | 0AGC005.VP |
| 6 | 0AGC006.V | 0AGC006.VP |
| 7.5 | 0AGC07.5V | 0AGC07.5VP |
| 8 | 0AGC008.V | - |
| 10 | 0AGC010.V | 0AGC010.VP |
| 15 | 0AGC015.V | 0AGC015.VP |
| 20 | 0AGC020.V | 0AGC020.VP |
| 25 | 0AGC025.V | 0AGC025.VP |
| 30 | 0AGC030.V | 0AGC030.VP |
| 35 | 0AGC035.V | 0AGC035.VP |

| CURRENT RATING (A) | BOXED | CARDED |
|--------------------|-----------------|---------------------------|
| | MATERIAL NUMBER | PACKAGING MATERIAL NUMBER |
| AGU (5AG) | | |
| 10 | 0AGU010.T | - |
| 15 | 0AGU015.T | - |
| 20 | 0AGU020.T | - |
| 25 | 0AGU025.T | - |
| 30 | 0AGU030.T | - |
| 35 | 0AGU035.T | - |
| 40 | 0AGU040.T | 0AGU040.VPG |
| 50 | 0AGU050.T | 0AGU050.VPG |
| 60 | 0AGU060.T | 0AGU060.VPG |
| AGX (8AG) | | |
| 20 | - | 0AGX020.VP |
| 25 | - | 0AGX025.VP |
| 30 | - | 0AGX030.VP |



SFE • Glass Fuses

Glass fuses designed to specifications set by the Society of Fuse Engineers. All are 1/4 inch in diameter, but vary in length according to the ampere rating to ensure accurate fuse replacement.

Voltage Rating: 32V AC/DC, 250V may be substituted

Additional information: littelfuse.com/Glass

| CURRENT RATING (A) | BOXED | CARDED |
|--------------------|-----------------|---------------------------|
| | MATERIAL NUMBER | PACKAGING MATERIAL NUMBER |
| 4 | 0SFE004.V | 0SFE004.VP |
| 6 | 0SFE006.V | 0SFE006.VP |
| 7.5 | 0SFE007.5V | 0SFE007.5VP |
| 9 | 0SFE009.V | 0SFE009.VP |
| 14 | 0SFE014.V | 0SFE014.VP |
| 20 | 0SFE020.V | 0SFE020.VP |
| 30 | 0SFE030.V | 0SFE030.VP |



GBC • Torpedo Fuse

A thermoplastic type, torpedo shaped fuse that can be currently found in many European cars. Consisting of a heat resistant body, the fuse element stretches over the exterior of the body from end to end. The bodies vary in color (by amperage) to ensure proper replacement.

Voltage Rating: 32V AC/DC, 250V may be substituted

Additional information: littelfuse.com/Glass

| CURRENT RATING (A) | BOXED | CARDED |
|--------------------|-----------------|---------------------------|
| | MATERIAL NUMBER | PACKAGING MATERIAL NUMBER |
| 5 | 0GBC005.V | - |
| 8 | 0GBC008.V | 0GBC008.VP |
| 16 | 0GBC016.V | 0GBC016.VP |
| 25 | 0GBC025.V | 0GBC025.VP |

Specialty Fuse Products

CNNe, CNN, CNL Forklift Type Fuses

CNNe fuses are rated for applications up to 80V DC. As fork lift trucks voltages increase, circuit protection needs to be rated higher to handle the increased voltage. The 80V CNN_E and 48V CNN are considered very fast-acting for quicker reaction time, the 32V CNL fuses are fast-acting.

- Voltage Rating: CNL: 32V DC / 32V AC
CNN: 48V DC / 125V AC
CNNe: 80V DC / 125V AC
- Ampere Range: 10-800A
- Interrupting Rating: 2,500A
- Maximum Torque: 90 lbs

Download additional information: littelfuse.com/CNN



| PART NUMBER | | | PART NUMBER | | | PART NUMBER | | |
|-------------|-----------|------|-------------|-----------|------|-------------|-----------|------|
| MATERIAL # | CATALOG # | V DC | MATERIAL # | CATALOG # | V DC | MATERIAL # | CATALOG # | V DC |
| OCNN035E.V | CNN035E | 80 | OCNN010.V | CNN010 | 48 | OCNL035.V | CNL035 | 32 |
| OCNN040E.V | CNN040E | 80 | OCNN035.V | CNN035 | 48 | OCNL040.V | CNL040 | 32 |
| OCNN050E.V | CNN050E | 80 | OCNN040.V | CNN040 | 48 | OCNL050.V | CNL050 | 32 |
| OCNN060E.V | CNN060E | 80 | OCNN050.V | CNN050 | 48 | OCNL060.V | CNL060 | 32 |
| OCNN080E.V | CNN080E | 80 | OCNN060.V | CNN060 | 48 | OCNL080.V | CNL080 | 32 |
| OCNN090E.V | CNN090E | 80 | OCNN080.V | CNN080 | 48 | OCNL100.V | CNL100 | 32 |
| OCNN100E.V | CNN100E | 80 | OCNN090.V | CNN090 | 48 | OCNL125.V | CNL125 | 32 |
| OCNN125E.V | CNN125E | 80 | OCNN100.V | CNN100 | 48 | OCNL150.V | CNL150 | 32 |
| OCNN150E.V | CNN150E | 80 | OCNN125.V | CNN125 | 48 | OCNL175.V | CNL175 | 32 |
| OCNN175E.V | CNN175E | 80 | OCNN150.V | CNN150 | 48 | OCNL200.V | CNL200 | 32 |
| OCNN200E.V | CNN200E | 80 | OCNN175.V | CNN175 | 48 | OCNL250.V | CNL250 | 32 |
| OCNN225E.V | CNN225E | 80 | OCNN200.V | CNN200 | 48 | OCNL275.V | CNL275 | 32 |
| OCNN250E.V | CNN250E | 80 | OCNN225.V | CNN225 | 48 | OCNL300.V | CNL300 | 32 |
| OCNN275E.V | CNN275E | 80 | OCNN250.V | CNN250 | 48 | OCNL350.V | CNL350 | 32 |
| OCNN300E.V | CNN300E | 80 | OCNN275.V | CNN275 | 48 | OCNL400.V | CNL400 | 32 |
| OCNN325E.V | CNN325E | 80 | OCNN300.V | CNN300 | 48 | OCNL500.V | CNL500 | 32 |
| OCNN350E.V | CNN350E | 80 | OCNN325.V | CNN325 | 48 | | | |
| OCNN400E.V | CNN400E | 80 | OCNN350.V | CNN350 | 48 | | | |
| OCNN500E.V | CNN500E | 80 | OCNN400.V | CNN400 | 48 | | | |
| OCNN600E.V | CNN600E | 80 | OCNN500.V | CNN500 | 48 | | | |
| OCNN700E.V | CNN700E | 80 | OCNN600.V | CNN600 | 48 | | | |
| OCNN800E.V | CNN800E | 80 | OCNN700.V | CNN700 | 48 | | | |
| | | | OCNN800.V | CNN800 | 48 | | | |

160/300V DC • 1-1200A • UL Class T • JLLN & JLLS Series Fuses

- Voltage Rating: JLLN: 160V DC (1-60A) • 125V DC (70-1200A except 900A)
JLLS: 300V DC (1-1200A)

Download technical information at: littelfuse.com/JLLN or littelfuse.com/JLLS



| CURRENT RATING (A) | JLLN | | | JLLS | | | PACK SIZE | CURRENT RATING (A) | JLLN | | | JLLS | | | PACK SIZE |
|--------------------|------|-----------------|------|-----------------|------|-----------------|-----------|--------------------|------|-----------------|------|-----------------|--|--|-----------|
| | V DC | MATERIAL NUMBER | V DC | MATERIAL NUMBER | V DC | MATERIAL NUMBER | | | V DC | MATERIAL NUMBER | V DC | MATERIAL NUMBER | | | |
| 1 | 160 | JLLN001.T | 300 | JLLS001.T | 10 | 125 | 125 | JLLN125.X | 300 | JLLS125.X | 1 | | | | |
| 2 | 160 | JLLN002.T | 300 | JLLS002.T | 10 | 150 | 125 | JLLN150.X | 300 | JLLS150.X | 1 | | | | |
| 3 | 160 | JLLN003.T | 300 | JLLS003.T | 10 | 175 | 125 | JLLN175.X | 300 | JLLS175.X | 1 | | | | |
| 6 | 160 | JLLN006.T | 300 | JLLS006.T | 10 | 200 | 125 | JLLN200.X | 300 | JLLS200.X | 1 | | | | |
| 10 | 160 | JLLN010.T | 300 | JLLS010.T | 10 | 225 | 125 | JLLN225.X | 300 | JLLS225.X | 1 | | | | |
| 15 | 160 | JLLN015.T | 300 | JLLS015.T | 10 | 250 | 125 | JLLN250.X | 300 | JLLS250.X | 1 | | | | |
| 20 | 160 | JLLN020.T | 300 | JLLS020.T | 10 | 300 | 125 | JLLN300.X | 300 | JLLS300.X | 1 | | | | |
| 25 | 160 | JLLN025.T | 300 | JLLS025.T | 10 | 350 | 125 | JLLN350.X | 300 | JLLS350.X | 1 | | | | |
| 30 | 160 | JLLN030.T | 300 | JLLS030.T | 10 | 400 | 125 | JLLN400.X | 300 | JLLS400.X | 1 | | | | |
| 35 | 160 | JLLN035.T | 300 | JLLS035.T | 10 | 450 | 125 | JLLN450.X | 300 | JLLS450.X | 1 | | | | |
| 40 | 160 | JLLN040.T | 300 | JLLS040.T | 10 | 500 | 125 | JLLN500.X | 300 | JLLS500.X | 1 | | | | |
| 45 | 160 | JLLN045.T | 300 | JLLS045.T | 10 | 600 | 125 | JLLN600.X | 300 | JLLS600.X | 1 | | | | |
| 50 | 160 | JLLN050.T | 300 | JLLS050.T | 10 | 700 | 125 | JLLN700.X | 300 | JLLS700.X | 1 | | | | |
| 60 | 160 | JLLN060.T | 300 | JLLS060.T | 10 | 800 | 125 | JLLN800.X | 300 | JLLS800.X | 1 | | | | |
| 70 | 125 | JLLN070.V | 300 | JLLS070.V | 5 | 900 | - | - | 300 | JLLS900.X | 1 | | | | |
| 80 | 125 | JLLN080.V | 300 | JLLS080.V | 5 | 1000 | 125 | JLLN1000X | 300 | JLLS1000X | 1 | | | | |
| 90 | 125 | JLLN090.V | 300 | JLLS090.V | 5 | 1100 | 125 | JLLN1100X | 300 | JLLS1100X | 1 | | | | |
| 100 | 125 | JLLN100.V | 300 | JLLS100.V | 5 | 1200 | 125 | JLLN1200X | 300 | JLLS1200X | 1 | | | | |
| 110 | 125 | JLLN110.X | 300 | JLLS110.X | 1 | | | | | | | | | | |

Honda, Volkswagen and Universal Fusible Links

- Honda** Fusible links fit Honda Civics fusible link bar. Available in 45, 55 & 65A. Carded merchandise only available in 3 piece assortment 094413.
- Volkswagen** Fusible links fit Volkswagen and Universal fusible link bars. Available in 30, 40, 50, 60, 80, 110, 150 & 175 amp fuse bars.
- Universal** Fusible links are OEM replacement fusible link bars. Available in 30, 50, 80 & 100A.



| CARDERD PART NUMBER | | DESCRIPTION |
|---------------------|----------------|---|
| MATERIAL NUMBER | CATALOG NUMBER | |
| 00940413ZP | 094413 | Fusible Link assortment - fits Honda™ vehicles |
| 00940402ZP | 0940402 | Fusible Link assortment - fits Volkswagen™ vehicles |
| OFLC014.XP | FLC14BP | Fusible Link 14 AWG |
| OFLW014.XP | FLW14BP | Fusible Link 14 AWG with Terminals |
| OFLW016.XP | FLW16BP | Fusible Link 16 AWG with Terminals |

Assortment Kits

Value Pack Kits

1

The Littelfuse Value Packs contain a complete assortment of OEM fuses. Value Packs give you the tools for the protection you need — when and where you need it! The Ultimate fuse kit for home and repair shop comes in a clear plastic, reusable package.



| MATERIAL NUMBER | CATALOG NUMBER | DESCRIPTION |
|-----------------|----------------|--|
| 00940400Z | 094400 | ATO Super Value Pack 40pc |
| 00940462Z | 094462 | MINI Super Value Pack 40pc |
| 00940475Z | 094475 | ATO , MINI, MAXI Super Value Pack 21pc |
| 00940550Z | 094550 | MINI /JCASE Super Value Pack 29pc |
| 00940554Z | — | Low Profile MINI / Low Profile JCASE Super Value Pack 30pc |
| 00940557ZXA | — | AGC Glass Super Value Pack 40pc |
| 00940566ZXA | — | MICRO2/MICRO3 Super Value Pack 60pc |

Fuse Assortment Kits

Littelfuse assortments contain a variety of a specific fuse type in assorted amperages.



| MATERIAL NUMBER | CATALOG NUMBER | DESCRIPTION | CONTENTS |
|-----------------|----------------|----------------------------------|--|
| 00940133ZP | 94133 | European Fuse Assortment | 2 each: GBC 8A, 16A Fuses & 1 each: GBC 25 A |
| 00940134ZP | 94134 | British Fuse Assortment | 1 each: AGC 7.5A, 15A, 20A (SFE 20) 1 each: 03000128M Amp Fuses |
| 00940135ZP | 94135 | Japanese Fuse Assortment | 1 each: AGC 5A, 10A, 15A, 20A (SFE 20), 30A Fuses |
| 00940154ZP | 94154 | American Fuse Assortment | 1 each: AGC 10A, 15A, 30A & 1 each: SFE 9A, 14A, 20A Fuses |
| 00940189ZP | 94189 | Cellular Fuse Assortment | 1 each: AGC 1.5A, 3A Fuses & 3 each: AGC 2A Fuses |
| 00940202ZP | 94202 | ATO Fuse Assortment 6pc | 1 each: ATO 5A, 10A, 15A, 20A, 25A, 30A Fuses |
| 00940301ZP | 94301 | Japanese ATO Fuse Assortment | 1 each: ATO 5A, 7.5A, 10A, 15A, 20A Fuses |
| 00940362ZP | 94362 | MINI Fuse Assortment | 1 each: MINI 3A, 5A, 7.5A, 10A, 15A, 20A, 25A, 30A |
| 00940408ZP | 94408 | Computer Fuse Assortment | 1 each: AGC .5A Fuses & 2 each: AGC 1A, 2A Fuses |
| 00940506ZP | 94506 | Low Profile MINI Fuse Assortment | 1 each: LMIN 7.5A, 10A, 15A, 20A, 25A, 30A Fuses |
| 00940558ZPA | 94558 | MICRO2 Fuse Assortment | 1 each: MICRO2 5A, 10A, 15A, 20A, 25A Fuses |
| 00940559ZPA | 94559 | MCASE Fuse Assortment | 1 each: 15A, 20A, 25A, 30A, 40A Fuses |
| 0AGA0001ZP | AGA1ZP | AGA Glass Fuse Assortment | 1 each: AGA 1A, 2A, 3A, 5A, 7.5A, 10A, 15A, 20A, 25A, 30A Fuses |
| 0AGA0002ZP | AGA2ZP | AGA Glass Fuse Assortment | 1 each: AGA 2A, 3A, 10A Fuses & 2 each: AGA 5A Fuses NEW |
| 0AGA0003ZP | AGA3ZP | AGA Glass Fuse Assortment | 1 each: AGA 15A Fuse & 2 each: AGA 20A, 30A Fuses NEW |
| 0AGC0001ZP | AGC1ZP | AGC Glass Fuse Assortment | 1 each: AGC 1A, 2A, 2.5A, 3A, 4A, 5A, 6A, 7.5A, 8A, 10A, 15A, 20A, 25A, 30A, 35A Fuses |
| 0AGC0002ZP | AGC2ZP | AGC Glass Fuse Assortment | 1 each: AGC 1A, 2A, 2.5A Fuses & 2 each: AGC 3A Fuses NEW |
| 0AGC0003ZP | AGC3ZP | AGC Glass Fuse Assortment | 1 each: AGC 4A, 6A, 7.5A Fuses & 2 each: AGC 5A Fuses NEW |
| 0AGC0004ZP | AGC4ZP | AGC Glass Fuse Assortment | 1 each: AGC 10A Fuse & 2 each: AGC 15A, 20A Fuses NEW |
| 0AGC0005ZP | AGC5ZP | AGC Glass Fuse Assortment | 1 each: AGC 35A Fuse & 2 each: AGC 25A, 30A Fuses NEW |
| 0AGW0001ZP | AGW1ZP | AGW/AGX Glass Fuse Assortment | 1 each: AGW 3A, 4A, 5A, 15A, 20A, 30A Fuses 1 each: AGX 3A, 20A, 25A, 30A Fuses |
| 0AGW0002ZP | AGW2ZP | AGW Glass Fuse Assortment | 1 each: AGW 5A, 20A, 30A Fuses & 2 each: AGW 15A Fuses NEW |
| 0AGX0002ZP | AGX2ZP | AGX Glass Fuse Assortment | 1 each: AGX 25A, 30A Fuses & 3 each: AGX 20A Fuses NEW |
| 0SFE0001ZP | SFE1ZP | SFE Glass Fuse Assortment | 1 each: SFE 4A, 6A, 7.5A, 9A Fuses & 2 each: 14A, 20A, 30A Fuses |

SMART GLOW Fuse



| MATERIAL NUMBER | CATALOG NUMBER | DESCRIPTION | CONTENTS |
|-----------------|----------------|--|---|
| 00940202ZPGL0 | 10-1008 | ATO SmartGlow Assortment 5 pack | 1 each: ATO 10A, 15A, 20A, 25A, 30A Fuses |
| 00940362ZPGL0 | 11-1008 | MINI SmartGlow Assortment 5 pack | 1 each: MINI 10A, 15A, 20A, 25A, 30A Fuses |
| 00940400ZGL0 | 14-0000 | ATO SmartGlow Assortment 42 pack | 7 each: ATO GLO 5A, 10A, 15A, 20A, 25A, 30A Fuses |
| 00940462ZGL0 | 15-0000 | MINI SmartGlow Assortment 36 pack | 6 each: MINI GLO 5A, 10A, 15A, 20A, 25A, 30A Fuses |
| 00940555ZPGL0 | — | ATO SmartGlow Assortment 5 pack w/ Flashlight | 1 each: ATO GLO 10A, 15A, 20A, 25A, 30A Fuses & (1) MINI Keychain LED Flashlight |
| 00940556ZPGL0 | 094556 | MINI SmartGlow Assortment 5 Pack w/ Flashlight | 1 each: MINI GLO 10A, 15A, 20A, 25A, 30A Fuses & (1) MINI Keychain LED Flashlight |
| 0AGC0001ZPGL0 | 16-1008 | AGC Glass Assortment 5 pack | 1 each: AGC 5A, 10A, 15A, 20A, 30A Fuses |
| 0SFE0001ZPGL0 | — | SFE Glass SmartGlow Assortment 5 pack | 1 each: SFE 7.5A, 9A, 14A & 2 each: 20A Fuses |

Assortment Kits



Emergency Kits

Available in OEM ATO and MINI fuse versions. The Littelfuse Emergency Diagnostic Fuse Kits are ideal for the glove box or trunk offering instant protection in the garage or on the road. Contains the most popular amperages.

Includes roadside tester/puller that tests, removes and installs fuses. Has its own power source that allows it to operate with or without voltage to a maximum of 24V DC.



| MATERIAL NUMBER | CATALOG NUMBER | DESCRIPTION | CONTENTS |
|-----------------|----------------|---|---|
| 00940363ZP | 094363 | MINI Emergency Fuse Kit | 1 each: MINI 3A, 5A, 7.5A, 10A, 15A, 20A, 25A, 30A Fuses (1) Puller |
| 00940365ZP | 094365 | Motorcycle Glass Emergency Kit | 1 each: AGX 5A, 10A, 15A, 20A Fuses 2 each: AGX 8A Fuses (1) Puller |
| 00940366ZP | 094366 | Motorcycle ATO Emergency Kit | 1 each: ATO 5A, 7.5A, 10A, 15A, 20A Fuses (1) Puller |
| 00940367ZP | 094367 | American Glass Emergency Kit | 1 each: SFE 9A, 14A, 20A 1 each: AGC 5A, 15A, 30A Fuses (1) Puller |
| 00940368ZP | 094368 | European GBC Emergency Kit | 1 each: GBC 5A, 16A, 25A Fuses 2 each: GBC 8A Fuses (1) Puller |
| 00940369ZP | 094369 | Japanese Glass Emergency Kit | 1 each: AGC 5A, 10A, 15A, 20A, 30A Fuses (1) Puller |
| 00940370ZP | 094370 | ATO Emergency Kit | 1 each: ATO 5A, 10A, 15A, 20A, 25A, 30A Fuses (1) Puller |
| 00940418ZP | 094418 | ATO Emergency Diagnostic Kit | 1 each: ATO 5A, 10A, 15A, 20A, 25A, 30A Fuses (1) ATO Puller |
| 00940419ZP | 094419 | Glass Emergency Fuse Kit | 1 each: AGC 7.5, 15A, 20A, 25A, 30A (1) Glass Puller |
| 00940461ZP | 094461 | MINI Emergency Diagnostic Kit | 1 each: MINI 3A, 4A, 7.5A, 10A, 15A, 20A, 25A, 30A Fuses (1) ATO/MINI Tester/Puller |
| 00940479ZP | 094479 | ATO/MINI Emergency Diagnostic Kit | 1 each: ATO 5A, 10A, 15A, 20A, 25A, 30A Fuses 1 each: MINI 3A, 5A, 7.5A, 10A, 15A, 20A, 25A, 30A Fuses (1) Puller |
| 00940441ZP | 094441 | LP MINI Emergency Fuse Kit | 1 each: LP MINI 2A, 5A, 7.5A, 10A, 15A, 20A, 25A, 30A Fuses, (1) Puller |
| 00940442ZP | 094442 | MCASE, MICRO2, MICRO3 Emergency Kit | 1 each: MCASE 15A, 20A, 25A, 30A, 40A Fuses, (1) MCCase Puller 1 each: MICRO2 5A, 7.5A, 10A, 15A, 20A, 25A, 30A Fuses 1 each: MICRO3 5A, 7.5A, 10A, 15A Fuses, (1) MICRO Puller |
| 00940561ZPA | 094561 | OEM Emergency Kit - GM | 1 each: MINI 7.5A, 25A, 30A Fuses 1 each: LP MINI 10A, 15A Fuses 1 each: JCASE 20A, 30A, 40A, 50A Fuses 1 each: LPJCASE 30A, 40A Fuses 2 each: MINI 20A Fuses 3 each: MINI 10A, 15A Fuses |
| 00940562ZPA | 094562 | OEM Emergency Kit - Ford | 1 each: MINI 7.5A, 25A, 30A Fuses 1 each: LP MINI 10A, 15A Fuses 1 each: JCASE 20A, 30A, 40A, 50A Fuses 1 each: LPJCASE 30A, 40A Fuses 2 each: MINI 20A Fuses 3 each: MINI 10A, 15A Fuses |
| 00940563ZPA | 094563 | OEM Emergency Kit - Chrysler/Dodge/Jeep | 1 each: MINI 7.5A, 25A, 30A Fuses 1 each: JCASE 20A, 30A, 40A, 50A Fuses 2 each: MINI 20A Fuses 3 each: MINI 10A, 15A Fuses |
| 00940565ZPA | 094565 | Toyota/Lexus Emergency Fuse Kit | 1 each: MICRO2 5A, 7.5A, 10A, 15A, 20A, 25A, 30A Fuses 1 each: LP MINI 5A, 7.5A, 10A, 15A, 20A, 30A Fuses (2) Pullers |
| 00940566ZPA | 094566 | Nissan/Infiniti Emergency Fuse Kit | 1 each: MICRO2 5A, 10A, 15A, 20A, 30A Fuses 1 each: MINI 2A, 3A, 4A, 5A, 7.5A, 10A, 15A, 20A, 25A, 30A Fuses 1 each: ATO 5A, 7.5A, 10A, 15A, 20A, 30A, 40A Fuses 1 each: MCASE+ 30A, 40A, 60A, Fuses 2 each: MCASE+ 50A Fuses (3) Pullers |
| 00940567ZPA | 094567 | Volkswagen/Audi Emergency Fuse Kit | 1 each: ATO 1A, 2A, 3A, 4A, 5A, 7.5A, 10A, 15A, 20A, 25A, 30A, 40A Fuses 1 each: MINI 2A, 3A, 5A, 7.5A, 10A, 15A, 20A, 25A, 30A Fuses 1 each: JCASE 20A, 25A, 30A, 40A, 50A, 60A Fuses 1 each: HSB 40A, 50A, 80A, 110A, 175A Fuse Strip (2) Pullers |
| 00940569ZPA | 094569 | Hyundai/Kia/Genesis Emergency Fuse Kit | 1 each: MINI 10A, 15A, 20A, 25A, 30A Fuses 1 each: LP MINI 7.5A, 10A, 15A, 20A, 25A, 30A Fuses 1 each: JCASE 30A, 40A, 50A Fuses 1 each: LPJCASE 20A, 30A, 40A Fuses 1 each: MICRO2 10A, 15A, 20A, 25A, 30A Fuses (3) Pullers |

NEW

NEW

NEW

NEW

Assortment Kits

1

Commercial Assortments

Littelfuse Commercial Assortments cover all of the professional technician's circuit protection needs. Littelfuse offers the most comprehensive circuit protection kits on the market today addressing the needs of the Professional Service Center and Road Service Operation with genuine Littelfuse OEM fuses. Littelfuse Commercial Assortments are designed for the professional installer who needs a larger quantity and variety of fuses at the point of installation. Assortments are packaged in tough plastic storage containers perfect for the parts drawer, tool box, under counter or road service vehicle.

Additional information: littelfuse.com/KitAssortments



ATO® Fuse
80 Piece Commercial Assortment



| CARDED | MATERIAL NUMBER | CATALOG NUMBER | CONTENT |
|--------|-----------------|----------------|--|
| | 00940409Z | 094409 | ATO (10-pc): 3A, 5A, 7.5A, 10A, 15A, 20A, 25A, 30A |



ATO® / MINI® Fuse
80 Piece Commercial Assortment



| CARDED | MATERIAL NUMBER | CATALOG NUMBER | CONTENT |
|--------|-----------------|----------------|---|
| | 00940422Z | 094422 | ATO (10-pc): 15A, 20A, 25A, 30A MINI (10-pc): 15A, 20A, 25A, 30A (1) Puller |



MINI® Fuse
80 Piece Commercial Assortment



| CARDED | MATERIAL NUMBER | CATALOG NUMBER | CONTENT |
|--------|-----------------|----------------|---|
| | 00940551Z | 094551 | MINI (10-pc): 3A, 5A, 7.5A, 10A, 15A, 20A, 25A, 30A |



Low Profile MINI® Fuse
80 Piece Commercial Assortment



| CARDED | MATERIAL NUMBER | CATALOG NUMBER | CONTENT |
|--------|-----------------|----------------|---|
| | 00940552Z | 094552 | LPMINI (10-pc): 3A, 5A, 7.5A, 10A, 15A, 20A, 25A, 30A |



MICRO2® Fuse
70 Piece Commercial Assortment



| CARDED | MATERIAL NUMBER | CATALOG NUMBER | CONTENT |
|--------|-----------------|----------------|--|
| | 00940560ZXA | 00940560 | MICRO2 (10): 5A, 7.5A, 10A, 15A, 20A, 25A, 30A |



MICRO2® MICRO3® MCASE® Fuse
135 Piece Commercial Assortment



| CARDED | MATERIAL NUMBER | CATALOG NUMBER | CONTENT |
|--------|-----------------|----------------|--|
| | 00940570ZXA | 00940570 | MICRO2 (10): 5A, 7.5A, 10A, 15A, 20A, 25A, 30A MICRO3 (10): 5A, 7.5A, 10, 15A MCASE (5): 15A, 20A, 25A, 30A, 40A |



MCASE® Fuse
80 Piece Commercial Assortment



| CARDED | MATERIAL NUMBER | CATALOG NUMBER | CONTENT |
|--------|-----------------|----------------|-------------------------------------|
| | 00940565ZXA | 00940565 | MCASE (20): 15A, 20A, 25A, 30A, 40A |



JCASE® Fuse
10 Piece Commercial Assortment



| CARDED | MATERIAL NUMBER | CATALOG NUMBER | CONTENT |
|--------|-----------------|----------------|--|
| | 00940480Z | 094480 | JCASE (2-pc): 20A, 40A, 50A JCASE (3-pc): 30A - JCASE (1-pc): 60A (1) Puller |



Low Profile JCASE® Fuse
16 Piece Commercial Assortment



| CARDED | MATERIAL NUMBER | CATALOG NUMBER | CONTENT |
|--------|-----------------|----------------|---|
| | 00940553Z | 094553 | LPJCASE (4-pc): 20A, 30A, 40A LPJCASE (2-pc): 50A, 60A (1) Puller |

Assortment Kits

SMART GLOW FUSE



It glows when it blows.

Smart Glow Commercial Assortments

Littelfuse Commercial Assortments cover the professional technician's circuit protection needs including Smart Glow style fuses. Available in ATO and MINI fuse styles the assortments are packaged in tough plastic storage containers perfect for the parts drawer, tool box, under counter or road service vehicle.

Additional information: littelfuse.com/KitAssortments



**Smart Glow ATO® Blade Fuse
80 Piece Commercial Assortment**



**Smart Glow MINI® Blade Fuse
80 Piece Commercial Assortment**

| CARDED | MATERIAL NUMBER | CONTENT |
|--------|-----------------|--|
| | 00940509ZXGLOA | ATO (10-pc): 3A, 5A, 7.5A, 10A, 15A, 20A, 25A, 30A |

| CARDED | MATERIAL NUMBER | CONTENT |
|--------|-----------------|---|
| | 00940510ZXGLOA | MINI (10-pc): 3A, 5A, 7.5A, 10A, 15A, 20A, 25A, 30A |



Professional Fuse Caddy

Provides a complete assortment designed to meet the professional installer's on-the-road fuse needs. Contains 180 of the most popular fuses and installation tools (includes ATO®/MINI® Tester/ Puller) needed to service passenger cars and light trucks, heavy and medium trucks and buses.

Comes in compact handy storage box perfect for the on-the-road vehicle.

Additional information: littelfuse.com/KitAssortments

| CARDED | MATERIAL NUMBER | CATALOG NUMBER | CONTENT |
|--------|-----------------|----------------|--|
| | 00940396Z | 094396 | ATO (5-pc): 3A, 5A, 7.5A - ATO (10-pc): 10A, 25A - ATO (15-pc): 15A, 20A, 20A MINI (5-pc): 2A, 3A, 4A, 5A, 7.5A, 10A, 15A, 20A, 25A, 30A AGC (5-pc): 5A, 10A, 15A, 20A, 25A, 30A SFE (5-pc): 14A, 20A, 30A MAXI (1-pc): 20A, 30A, 40A, 50A, 60A (1) Fuse Tester and Puller (1) Tri-puller™ (1) MAXI Fuse Puller |

Assortment Kits

1



Red Box™

Designed by Littelfuse, the kit features the exact OEM parts used for the glass, ATO, MINI, LP MINI, MAXI, PAL, JCASE, LP JCASE, MCASE, MICRO2 and MICRO3 fuses installed on over 98% of the cars, vans, light trucks and SUV's on the road today. All come packed inside one compact, portable, organized carrying case. With Red Box, your days of wasting valuable shelf space on redundant part numbers is over. Over 500 fuses inside Red Box meet over 98% of the market's circuit protection needs, giving you more coverage and more profit with a lot less inventory.

Additional information: littelfuse.com/RedBox

KIT Professional Installer Case

| MATERIAL NUMBER | CATALOG NUMBER |
|-----------------|----------------|
| ORED0BOXZ | REDBOX |

KIT Professional Installer Case (No Glass with Module 5)

| MATERIAL NUMBER | CATALOG NUMBER |
|-----------------|----------------|
| ORED0BOXZNG | REDBOXNG |

KIT Professional Installer Case (No Glass with Module 6)

| MATERIAL NUMBER |
|-----------------|
| ORED0BOXZNGA |

Glass Module (Module 5)

| MATERIAL NUMBER | CATALOG NUMBER | |
|-----------------|--------------------|----|
| ORBOX005Z | RBOX5 | |
| 0AGC001.V | AGC GLASS BOX 1A | 10 |
| 0AGC002.V | AGC GLASS BOX 2A | 10 |
| 0AGC003.V | AGC GLASS BOX 3A | 10 |
| 0AGC004.V | AGC GLASS BOX 4A | 10 |
| 0AGC005.V | AGC GLASS BOX 5A | 10 |
| 0AGC006.V | AGC GLASS BOX 6A | 10 |
| 0AGC007.5V | AGC GLASS BOX 7.5A | 10 |
| 0AGC010.V | AGC GLASS BOX 10A | 10 |
| 0AGC015.V | AGC GLASS BOX 15A | 10 |
| 0AGC020.V | AGC GLASS BOX 20A | 10 |
| 0AGC025.V | AGC GLASS BOX 25A | 10 |
| 0AGC030.V | AGC GLASS BOX 30A | 10 |
| 0AGW030.V | AGW GLASS BOX 30A | 10 |
| 0AGX030.V | AGX GLASS BOX 30A | 10 |
| 0SFE004.V | SFE GLASS BOX 4A | 10 |
| 0SFE009.V | SFE GLASS BOX 9A | 10 |
| 0SFE014.V | SFE GLASS BOX 14A | 10 |
| 0SFE020.V | SFE GLASS BOX 20A | 10 |
| 0SFE030.V | SFE GLASS BOX 30A | 10 |
| | Puller Tester | 1 |

Low Profile MINI® Module (Module 1)

| MATERIAL NUMBER | CATALOG NUMBER | |
|-----------------|----------------------------|----|
| ORBOX001Z | RBOX1 | |
| LMIN005.V | 5A LOW PROFILE MINI FUSE | 5 |
| LMIN07.5V | 7.5A LOW PROFILE MINI FUSE | 10 |
| LMIN010.V | 10A LOW PROFILE MINI FUSE | 10 |
| LMIN015.V | 15A LOW PROFILE MINI FUSE | 10 |
| LMIN020.V | 20A LOW PROFILE MINI FUSE | 5 |
| LMIN025.V | 25A LOW PROFILE MINI FUSE | 5 |
| LMIN030.V | 30A LOW PROFILE MINI FUSE | 10 |

JCASE® Module (Module 2)

| MATERIAL NUMBER | CATALOG NUMBER | |
|-----------------|-----------------------|---|
| ORBOX002Z | RBOX2 | |
| JCAS020.V | JCASE 32V S/B BOX 20A | 2 |
| JCAS030.V | JCASE 32V S/B BOX 30A | 2 |
| JCAS040.V | JCASE 32V S/B BOX 40A | 2 |
| JCAS050.V | JCASE 32V S/B BOX 50A | 2 |
| JCAS060.V | JCASE 32V S/B BOX 60A | 2 |

Blade Fuse Module (Module 3)

| MATERIAL NUMBER | CATALOG NUMBER | |
|-----------------|--------------------------------|----|
| ORBOX003Z | RBOX3 | |
| 0ATO005.V | ATO BLADE FUSE BOX 5A | 10 |
| 0ATO07.5V | ATO BLADE FUSE BOX 7.5A | 10 |
| 0ATO010.V | ATO BLADE FUSE BOX 10A | 25 |
| 0ATO015.V | ATO BLADE FUSE BOX 15A | 25 |
| 0ATO020.V | ATO BLADE FUSE BOX 20A | 25 |
| 0ATO025.V | ATO BLADE FUSE BOX 25A | 25 |
| 0ATO030.V | ATO BLADE FUSE BOX 30A | 25 |
| 0ATO040.V | ATO BLADE FUSE BOX 40A | 10 |
| 0MIN005.V | MINI BLADE FUSE BOX 5A | 10 |
| 0MIN07.5V | MINI BLADE FUSE BOX 7.5A | 10 |
| 0MIN010.V | MINI BLADE FUSE BOX 10A | 20 |
| 0MIN015.V | MINI BLADE FUSE BOX 15A | 20 |
| 0MIN020.V | MINI BLADE FUSE BOX 20A | 20 |
| 0MIN025.V | MINI BLADE FUSE BOX 25A | 10 |
| 0MIN030.V | MINI BLADE FUSE BOX 30A | 10 |
| 0MAX020.V | MAXI BLADE BOX 20A | 2 |
| 0MAX030.V | MAXI BLADE BOX 30A | 2 |
| 0MAX040.V | MAXI BLADE BOX 40A | 2 |
| 0MAX050.V | MAXI BLADE BOX 50A | 2 |
| 0MAX060.V | MAXI BLADE BOX 60A | 2 |
| 0MAX070.V | MAXI BLADE BOX 70A | 1 |
| 0MAX080.V | MAXI BLADE BOX 80A | 1 |
| 00970019X | FUSE TESTER AND PULLER BOX | 1 |
| FHAC0002Z | ATO HD INLINE FUSE HOLDER BOX | 1 |
| 0FHM0002Z | MINI HD INLINE FUSE HOLDER BOX | 1 |

PAL Module (Module 4)

| MATERIAL NUMBER | CATALOG NUMBER | |
|-----------------|--------------------------------|---|
| ORBOX004Z | RBOX4 | |
| OPAL020.X | FEMALE TERM BOX 20A | 1 |
| OPAL030.X | FEMALE TERM BOX 30A | 1 |
| OPAL040.X | FEMALE TERM BOX 40A | 1 |
| OPAL050.X | FEMALE TERM BOX 50A | 1 |
| OPAL060.X | FEMALE TERM BOX 60A | 1 |
| OPAL130.X | STRAIGHT MALE TERM BOX 30A | 1 |
| OPAL160.X | STRAIGHT MALE TERM BOX 60A | 1 |
| OPAL180.X | STRAIGHT MALE TERM BOX 80A | 1 |
| OPAL1100.X | STRAIGHT MALE TERM BOX 100A | 1 |
| OPAL1120.X | STRAIGHT MALE TERM BOX 120A | 1 |
| OPAL230.X | 13/16" BENT MALE TERM BOX 30A | 1 |
| OPAL240.X | 13/16" BENT MALE TERM BOX 40A | 1 |
| OPAL250.X | 13/16" BENT MALE TERM BOX 50A | 1 |
| OPAL260.X | 13/16" BENT MALE TERM BOX 60A | 1 |
| OPAL270.X | 13/16" BENT MALE TERM BOX 70A | 1 |
| OPAL280.X | 13/16" BENT MALE TERM BOX 80A | 1 |
| OPAL2100.X | 13/16" BENT MALE TERM BOX 100A | 1 |
| OPAL2120.X | 13/16" BENT MALE TERM BOX 120A | 1 |
| OPAL330.X | MINI FEMALE TERM BOX 30A | 1 |
| OPAL340.X | MINI FEMALE TERM BOX 40A | 1 |
| OPAL430.X | 9/16" BENT MALE TERM BOX 30A | 1 |
| OPAL440.X | 9/16" BENT MALE TERM BOX 40A | 1 |
| OPAL450.X | 9/16" BENT MALE TERM BOX 50A | 1 |
| OPAL480.X | 9/16" BENT MALE TERM BOX 80A | 1 |
| OPAL4100.X | 9/16" BENT MALE TERM BOX 100A | 1 |
| OPAL525.X | LOCKING FEMALE TERM BOX 25A | 1 |
| OPAL530.X | LOCKING FEMALE TERM BOX 30A | 1 |

MICRO2®, MICRO3®, MCase®, Low Profile JCASE® Module (Module 6)

| MATERIAL NUMBER | CATALOG NUMBER | |
|-----------------|-----------------------|----|
| ORBOX006Z | RBOX6 | |
| MIC2005.V | MICRO2 Fuse 5A | 10 |
| MIC207.5V | MICRO2 Fuse 7.5A | 10 |
| MIC2010.V | MICRO2 Fuse 10A | 10 |
| MIC2015.V | MICRO2 Fuse 15A | 10 |
| MIC2020.V | MICRO2 Fuse 20A | 10 |
| MIC2025.V | MICRO2 Fuse 25A | 10 |
| MIC3005.V | MICRO3 Fuse 5A | 10 |
| MIC307.5V | MICRO3 Fuse 7.5A | 10 |
| MIC3010.V | MICRO3 Fuse 10A | 10 |
| MCAS020.V | MCASE Fuse 20A | 10 |
| MCAS025.V | MCASE Fuse 25A | 10 |
| MCAS030.V | MCASE Fuse 30A | 10 |
| MCAS040.V | MCASE Fuse 40A | 10 |
| LJCA020.V | LOW PROFILE JCASE 20A | 10 |
| LJCA025.V | LOW PROFILE JCASE 25A | 10 |
| LJCA030.V | LOW PROFILE JCASE 30A | 10 |
| LJCA040.V | LOW PROFILE JCASE 40A | 10 |
| LJCA050.V | LOW PROFILE JCASE 50A | 10 |
| LJCA060.V | LOW PROFILE JCASE 60A | 10 |

| MATERIAL NUMBER | CATALOG NUMBER |
|-----------------|----------------|
| ORBOX003ZGLO | RBOX3GLO |

Contact your local sales manager for more information

Assortment Kits

Modular Rack Systems

The new MRS Modular Rack System is a flexible offering of fuses that can be ordered based on your needs. Each rack is sold individually and can be locked together to sit on a counter, or wall mounted. They are also available as a complete kit. Size charts, and color identification charts are included to serve as a guide for easy identification and replacement.



OMRS0007ZXA

| MATERIAL NUMBER | CATALOG NUMBER | DESCRIPTION | CONTENTS |
|-----------------|----------------|---|--|
| OMRS0001Z | MRS1 | ATO Modular Rack System | See Table Below |
| OMRS0002Z | MRS2 | MINI-MAXI Modular Rack System | See Table Below |
| OMRS0003Z | MRS3 | Glass Modular Rack System | See Table Below |
| OMRS0004Z | MRS4 | PAL / MEGA Modular Rack System | See Table Below |
| OMRS0005Z | MRS5 | PAL / JCASE Modular Rack System | See Table Below |
| OMRS0006Z | MRS6 | ATO / MINI Assortments Modular Rack System | See Table Below |
| OMRS0007Z | MRS7 | Complete Modular Rack System - 6 Racks | MRS 1, 2, 3, 4, 5 & 6 - See Table Below |
| OMRS0007ZXA | MRS7A | Complete Modular Rack System - 7 Racks | MRS 1, 2, 3, 4, 5, 6 & 9 - See Table Below |
| OMRS0009ZXA | MRS9 | ACS / MICRO2 / MICRO3 / MCASE Modular Rack System | See Table Below |
| OMRS0200Z | MRS200 | ATO / MINI / MAXI Modular Rack System | MRS Racks 1 & 2 (Assembled) |
| OMRS0300Z | MRS300 | ATO / MINI / MAXI / Glass Modular Rack System | MRS Racks 1, 2 & 3 (Assembled) |

Modular Rack Systems Part Number Contents

| MATERIAL NUMBER | OMRS0001Z | OMRS0002Z | OMRS0003Z | OMRS0004Z | OMRS0005Z | OMRS0006Z | OMRS0009ZXA |
|-----------------|-------------|-------------|-----------------------|-------------|------------------------|------------------------|--------------------------|
| CATALOG NUMBER | MRS1 | MRS2 | MRS3 | MRS4 | MRS5 | MRS6 | MRS9 |
| FUSE TYPE | ATO | MINI / MAXI | GLASS / CERAMIC | PAL / MEGA | PAL / JCASE | ATO / MINI ASSORTMENTS | MICRO2 / MICRO3 / MCASE |
| CONTENTS | (5) ATO3 | (5) MIN2 | (5) AGC1 (10) SFE4 | (2) PAL20 | (1) PAL1120 (1) PAL430 | (12) 094202B | (2) MIC2 5 (3) MIC3 10 |
| | (5) ATO4 | (5) MIN3 | (5) AGC2 (10) SFE7.5 | (4) PAL30 | (1) PAL230 (1) PAL440 | (12) 094362B | (2) MIC2 7.5 (3) MIC3 15 |
| | (10) ATO5 | (5) MIN4 | (10) AGC3 (10) SFE9 | (3) PAL40 | (1) PAL240 (1) PAL450 | | (4) MIC2 10 (2) MCAS 15 |
| | (10) ATO7.5 | (10) MIN5 | (5) AGC5 (10) SFE14 | (3) PAL50 | (1) PAL250 (1) PAL480 | | (4) MIC2 15 (3) MCAS 20 |
| | (15) ATO10 | (10) MIN7.5 | (5) AGC7.5 (30) SFE20 | (2) PAL60 | (1) PAL260 (1) PAL4100 | | (4) MIC2 20 (2) MCAS 25 |
| | (15) ATO15 | (15) MIN10 | (10) AGC10 (10) SFE30 | (1) PAL130 | (1) PAL270 (1) PAL525 | | (3) MIC2 25 (4) MCAS 30 |
| | (20) ATO20 | (20) MIN15 | (20) AGC15 (10) GBC8 | (2) PAL160 | (1) PAL280 (1) PAL530 | | (3) MIC2 30A (3) MCAS 40 |
| | (10) ATO25 | (20) MIN20 | (20) AGC20 (10) GBC16 | (3) PAL180 | (1) PAL2100 (1) JCAS40 | | (3) MIC3 5 |
| | (15) ATO30 | (15) MIN25 | (10) AGC25 (10) GBC25 | (2) PAL1100 | (1) PAL2120 (1) JCAS50 | | (3) MIC3 7.5 |
| | (5) ATO40 | (15) MIN30 | (30) AGC30 | (2) MEG 175 | (1) JCAS20 (1) JCAS60 | | |
| | | (2) MAX20 | (5) AGW15 | | (2) JCAS30 | | |
| | | (3) MAX30 | (5) AGW20 | | (1) PAL330 | | |
| | | (2) MAX40 | | | (1) PAL340 | | |
| | (2) MAX50 | | | | | | |
| | (3) MAX60 | | | | | | |

Circuit Breakers

1

Type I • Automatic Reset

Cycles or continuously resets until the fault is corrected. Type I circuit breakers are typically used to protect circuits which occasionally experience momentary overloads such as wiper motor and headlamp circuits where a self resetting device is preferred.

Additional information: littelfuse.com/CircuitBreakers

Type II • Modified Reset

Non-cycling, remains in open position while there is power to the circuit. Resets when ignition is turned off. Type II circuit breakers are typically used in applications where fuse replacement is objectionable, such as power window, seat and sunroof circuits.

Type III • Manual Reset

Manually resettable circuit breakers remain in the open position until a button, lever or other external reset device is manually depressed. Type III circuit breakers are typically used in applications where a manual reset is desired for safe diagnosis of a circuit fault.

MINI® Footprint Circuit Breakers

Designed to fit in a MINI Blade fuse block or panel. SAE Type II used primarily as a wiring harness protector in 12V DC automotive systems. Conforms to SAE J553C standard.



| CURRENT RATING (A) | PART NUMBERS | |
|--------------------|--------------|-------------|
| | BULK | BOXED |
| 10 | 30419-10 | — |
| 15 | 30419-15 | 30419-15-BX |
| 20 | 30419-20 | 30419-20-BX |
| 25 | 30419-25 | 30419-25-BX |

Wide MINI® Footprint Circuit Breakers

Direct factory replacement for many domestic OEM applications. Designed to fit either in an ATO or MINI blade fuse block or panel. Their blade configuration is of the MINI design and fit in a standard ATO fuse slot or across two MINI slots. Available in either SAE Type I cycling or SAE Type II non-cycling used primarily as a wiring harness protector in 12V DC automotive systems. Conforms to SAE J553C standard.

| CURRENT RATING (A) | BOXED | APPLICATION | CYCLING | NON-CYCLING |
|--------------------|-----------------|------------------------|---------|-------------|
| | MATERIAL NUMBER | | | |
| 15 | 0MMB015.X | Heavy Truck Headlamp | • | |
| 20 | 0MMB020.X | Automotive Headlamp | • | |
| 10 | 0MNB010.X | Heavy Duty Truck | | • |
| 15 | 0MNB015.X | Heavy Duty Truck | | • |
| 20 | 0MNB020.X | Automotive/Heavy Truck | | • |
| 25 | 0MNB025.X | Automotive/Heavy Truck | | • |
| 30 | 0MNB030.X | Automotive/Heavy Truck | | • |

Specialty OEM ATO® Footprint Circuit Breakers

Direct factory replacement for many domestic OEM vehicles. SAE Type I and Type II modified reset used primarily as a wiring harness protector in 12V DC automotive systems. Conforms to SAE J553C standard. Designed to mount in ATO style fuse blocks and panels.



| CURRENT RATING (A) | BOXED | CARDED | APPLICATION | OEM PART NUMBER |
|--------------------|-----------------|-----------------|------------------------|---------------------------------------|
| | MATERIAL NUMBER | MATERIAL NUMBER | | |
| 20 | — | 0ACB020.XP | Automotive Headlamp | GM# 12040816 |
| 30 | — | 0ACB030.XP | Power Windows, & Locks | GM# 01252240 |
| 20 | 0FCB020.X | 0FCB020.XP | Power Windows | Ford# 83507005 |
| 25 | 0CCB025.X | 0CCB025.XP | Windows, Seats & Locks | Ford# D9AB-14526-BA Chrysler# 4527053 |

Fuse Clip Circuit Breakers

Direct replacement for many OEM applications. Designed for glass fuses without physical alteration in the system. Fits 1-1/4" fuse clips. SAE Type II non-cycling used primarily as a wiring harness protector in 12V DC automotive systems. Conforms to SAE J553C standard.



| CURRENT RATING (A) | PART NUMBERS | |
|--------------------|--------------|-------------|
| | BULK | BOXED |
| 10 | - | 30410-10-BX |
| 15 | 30410-15 | 30410-15-BX |
| 20 | 30410-20 | 30410-20-BX |
| 25 | 30410-25 | 30410-25-BX |
| 30 | 30410-30 | 30410-30-BX |

Circuit Breakers



Universal ATO® Footprint Circuit Breakers

Universal Circuit Breakers function identically and have same internal components as OEM breakers but offer the versatility of snap off terminals for greater flexibility. SAE Type II modified reset used primarily as a wiring harness protector in 12V DC automotive systems. Meets OEM requirements. Conforms to SAE J553C standard. Designed to mount in ATO style fuse blocks and panels.

| CURRENT RATING (A) | BOXED | BOXED BULK | CARDED |
|--------------------|-----------------|-----------------|---------------------------|
| | MATERIAL NUMBER | MATERIAL NUMBER | PACKAGING MATERIAL NUMBER |
| 5 | OUCB005.X | BUCB005.Z | OUCB005.XP |
| 10 | OUCB010.X | BUCB010.Z | OUCB010.XP |
| 15 | OUCB015.X | BUCB015.Z | OUCB015.XP |
| 20 | OUCB020.X | BUCB020.Z | OUCB020.XP |
| 25 | OUCB025.X | BUCB025.Z | OUCB025.XP |
| 30 | OUCB030.X | BUCB030.Z | OUCB030.XP |

MAXI Style Circuit Breakers

Direct factory replacement for many domestic OEM applications. Designed to fit a MAXI Blade fuse block or panel. Available in either SAE Type I cycling or SAE Type II non-cycling. Used primarily as a wiring harness protector in 12V DC automotive systems. Meet OEM requirements. Conforms to SAE J553C standard.

| CURRENT RATING (A) | BOXED | APPLICATION | CYCLING | NON CYCLING |
|--------------------|-----------------|---|---------|-------------|
| | MATERIAL NUMBER | | | |
| 20 | OMCB020.X | Automotive Headlamp | • | |
| 30 | OMCB030.X | Automotive Headlamp, Seats & Wipers | • | |
| 40 | OMCB040.X | – | • | |
| 20 | OMXB020.X | Automotive Power Devices Heavy Truck & Auto Cooling Fan | | • |
| 30 | OMXB030.X | Automotive Power Window Heavy Truck & Auto Cooling Fan & Power Window | | • |

Circuit Breaker Mounting Brackets & Bus Bars

Mounting brackets available in steel or nylon and accept 30056 and 30137 series breakers.

Bus bars are made from heavy solid brass or copper, with holes or slots that make it easy to connect box-type circuit breakers with studs, in order to feed a number of protected circuits.



30090-04 4-gang steel bracket



86099-5 brass busbar with holes



86126-4 copper busbar with slots

| PART NUMBERS | | DESCRIPTION | NUMBER OF GANGS | MATERIAL | DIMENSIONS | MOUNTING HOLE DIMENSIONS | NOTES |
|--------------|-------------|------------------|---------------------------------|------------------------------|---------------------------------|-------------------------------|--|
| BULK | BOXED | | | | | | |
| 30090-2 | 30090-2-BX | Mounting Bracket | 2 | Steel | .81" x 1.29" (122.2 x 32.8 mm) | 4.00" (101.6mm) on centers | For all steel breakers without a bracket. Breakers snap into position, engaging with dimples in the case of the breaker. |
| 30090-3 | 30090-3-BX | | 3 | | 5.71" x 1.29" (145.0 x 32.8mm) | 1.90" (124.5mm) on centers | |
| 30090-4 | 30090-4-BX | | 4 | | 6.62" x 1.29" (160.1 x 32.8mm) | 5.81" (147.6mm) on centers | |
| 30090-6 | 30090-6-BX | | 6 | | 8.43" x 1.29" (214.1 x 32.8mm) | 7.62" (193.5mm) on centers | |
| 30090-8 | 30090-8-BX | | 8 | | 10.25" x 1.29" (260.4 x 32.8mm) | 9.43" (239.5mm) on centers | |
| – | 86099-2-BX | Busbar | 2 | Brass | 1.53" long (38.9mm) | – | Holes: .910" (23.1mm) on centers, .021" (5.3mm) diameter |
| 86099-3 | 86099-3-BX | | 3 | | 2.43" long (61.7mm) | – | |
| 86099-4 | 86099-4-BX | | 4 | | 3.34" long (84.8mm) | – | |
| 86099-5 | 86099-5-BX | | 5 | | 4.24" long (107.7mm) | – | |
| 86126-2 | 86126-2-BX | | 2 | | Copper | 1.41" x .560" (35.8 x 14.2mm) | |
| 86126-4 | 86126-4-BX | 4 | 3.23" x .560" (82.1 x 14.2mm) | 2.73" (69.34mm) on centers | | | |
| 86126-6 | 86126-6-BX | 6 | 5.05" x .560" (128.3 x 14.2mm) | 4.55" (115.57mm) on centers | | | |
| 86126-8 | 86126-8-BX | 8 | 6.87" x .560" (174.5 x 14.2mm) | 6.37" (161.79mm) on centers | | | |
| 86126-12 | 86126-12-BX | 12 | 10.51" x .560" (267.0 x 14.2mm) | 10.01" (254.25mm) on centers | | | |

Box Style Circuit Breakers

1

Steel or plastic housing. Steel box type is approximately 1 1/4" x 3/4" x 2/3" and comes with integral brackets (to be directly affixed with screws or bolts) or without (needs a mounting bracket). Breakers have 10-32 studs, blades or wire leads. Wire lead type has a 10" wire loop connected to studs and PVC-coated. Loop is intended to be cut, stripped and spliced into a circuit.

Additional information: littelfuse.com/CircuitBreakers



30056, 30137, 30171 - with studs, no bracket



30055, 30138, 30172 - with studs and bracket



30128 - with studs and cross-bracket



3088, 30507 - double breaker assembly

Type I Steel Case with Stud Terminals

| PART NUMBERS | | | VOLT | AMPS | SEALED | NOTES | PART NUMBERS | | | VOLT | AMPS | SEALED | NOTES | PART NUMBERS | | | VOLT | AMPS | SEALED | NOTES |
|--------------|-------------|--------|------|------|----------|-------------|--------------|-------------|-------------|----------|-------------|--------|---------------------|--------------|-------------|--------|------|------|--------|--------|
| BULK | BOXED | RETAIL | | | | | BULK | BOXED | RETAIL | | | | | BULK | BOXED | RETAIL | | | | |
| 30056-10 | 30056-10-BX | - | 12 | 10 | - | Type I | 30055-10 | 30055-10-BX | - | 12 | 10 | - | Type I with bracket | 30171-10 | 30171-10-BX | - | 24 | 10 | - | Type I |
| 30056-15 | 30056-15-BX | - | | 15 | - | | 30055-15 | 30055-15-BX | 30055-15-BP | | 15 | - | | 30171-15 | 30171-15-BX | - | | 15 | - | |
| 30056-20 | 30056-20-BX | - | | 20 | - | | 30055-20 | 30055-20-BX | 30055-20-BP | | 20 | - | | 30171-20 | 30171-20-BX | - | | 20 | - | |
| 30056-25 | 30056-25-BX | - | | 25 | - | | 30055-25 | 30055-25-BX | - | | 25 | - | | 30171-30 | 30171-30-BX | - | | 30 | - | |
| 30056-30 | 30056-30-BX | - | | 30 | - | | 30055-30 | 30055-30-BX | 30055-30-BP | | 30 | - | | 30172-10 | - | - | | 10 | - | |
| 30056-40 | 30056-40-BX | - | | 40 | - | | 30055-40 | 30055-40-BX | 30055-40-BP | | 40 | - | | 30172-15 | 30172-15-BX | - | | 15 | - | |
| 30056-50 | 30056-50-BX | - | | 50 | - | | 30055-50 | 30055-50-BX | 30055-50-BP | | 50 | - | | 30172-20 | 30172-20-BX | - | | 20 | - | |
| 30137-10 | - | - | | 10 | • | | 30138-10 | - | - | | 10 | • | | 30172-30 | 30172-30-BX | - | | 30 | - | |
| 30137-15 | 30137-15-BX | - | | 15 | • | | 30138-15 | - | - | | 15 | • | | 3088-50 | - | - | | 50 | - | |
| 30137-20 | 30137-20-BX | - | | 20 | • | | - | 30138-30-BX | - | | 30 | • | | 3088-60 | 3088-60-BX | - | | 60 | - | |
| 30137-30 | - | - | 30 | • | 30138-40 | - | - | 40 | • | 3088-80 | 3088-80-BX | - | 80 | - | | | | | | |
| | | | | | 30128-10 | 30128-10-BX | - | 10 | - | 30507-60 | 30507-60-BX | - | 60 | • | | | | | | |
| | | | | | 30128-15 | 30128-15-BX | - | 15 | - | 30507-80 | 30507-80-BX | - | 80 | • | | | | | | |
| | | | | | 30128-20 | 30128-20-BX | - | 20 | - | | | | | | | | | | | |
| | | | | | 30128-30 | 30128-30-BX | - | 30 | - | | | | | | | | | | | |
| | | | | | 30128-40 | 30128-40-BX | - | 40 | - | | | | | | | | | | | |



30062 with wire leads, with bracket



30063 with wire leads, without bracket



Stud Type Low Voltage (6-12 V DC) Circuit Breakers

SAE Type I automatic reset provides protection in installations where it is not possible to manually reset a breaker because of location or safety requirements. Used primarily as a wiring harness protector in 12V DC automotive systems. Conforms to SAE J553C standard. Available with or without mounting bracket.

PVC-Coated Steel Case with Wire Terminals

| PART NUMBERS | | VOLT | AMPS | SEALED | NOTES |
|--------------|-------------|------|------|--------|---------------------|
| BULK | BOXED | | | | |
| - | 30062-20-BX | 12 | 20 | • | Type I with Bracket |
| 30062-30 | 30062-30-BX | | 30 | • | |
| 30063-10 | - | 12 | 10 | • | Type I |
| 30063-20 | 30063-20-BX | | 10 | • | |
| 30063-30 | - | | 30 | • | |

| CURRENT RATING (A) | BOXED W/O BRACKET | BOXED W/ BRACKET | CARDED |
|--------------------|-------------------|------------------|-----------------|
| | MATERIAL NUMBER | MATERIAL NUMBER | MATERIAL NUMBER |
| 5 | 0812005.ZXST | 0813005.ZXST | - |
| 6 | 0812006.ZXST | - | - |
| 8 | - | 0813008.ZXST | - |
| 10 | 0812010.ZXST | 0813010.ZXST | - |
| 15 | 0812015.ZXST | 0813015.ZXST | - |
| 20 | 0812020.ZXST | 0813020.ZXST | 0813020.XP |
| 25 | 0812025.ZXST | 0813025.ZXST | - |
| 30 | 0812030.ZXST | 0813030.ZXST | 0813030.XP |
| 4 | 0812040.ZXST | 0813040.ZXST | 0813040.XP |
| 50 | 0812050.ZXST | 0813050.ZXST | 0813050.XP |

Circuit Breakers

50-150A • 32V DC • Hi-Amp Type III • Circuit Breakers

These high amp circuit breakers are typically used in auxiliary and accessory circuits for trucks, buses, RVs and marine applications in battery charger systems and DC audio systems. All high amp circuit breakers comply with the SAE J1117 and J1625 standard for ignition protection.



- Agency Approvals: UL Approved for all amp ratings at 32V DC
- Interrupting Rating: 3000A @30V DC
- Ignition Protection: SAE J1625 and J1171
- Material: Thermoset Plastic UL Rating 94VO
- Temperature Range: -32C to 92C
- RoHS Compliant
- Waterproof

| CURRENT RATING (A) | BOXED PART NUMBERS | | CARDED PART NUMBERS | | INTERRUPTING RATING | RoHS |
|--------------------|--------------------|----------------|---------------------|----------------|---------------------|------|
| | MATERIAL NUMBER | CATALOG NUMBER | MATERIAL NUMBER | CATALOG NUMBER | | |
| 50 | 0185050.X | 185050 | – | – | 3000A @ 30V DC | • |
| 60 | 0185060.X | 185060 | – | – | 3000A @ 30V DC | • |
| 70 | 0185070.X | 185070 | – | – | 3000A @ 30V DC | • |
| 80 | 0185080.X | 185080 | – | – | 3000A @ 30V DC | • |
| 100 | – | – | 0185100.XP | 185100BP | 3000A @ 30V DC | • |
| 120 | – | – | 0185120.XP | 185120BP | 3000A @ 30V DC | • |
| 150 | – | – | 0185150.XP | 185150BP | 3000A @ 30V DC | • |



MINI® Type I Circuit Breakers

Designed to fit in a MINI blade fuse block or panel. Conforms to SAE J553. Cycles or continuously resets until the fault is corrected. Type I circuit breakers are typically used to protect circuits which occasionally experience momentary overloads such as wiper motor and headlamp circuits where a self resetting device is preferred.



| CURRENT RATING (A) | CARDED PART NUMBERS | |
|--------------------|---------------------|----------------|
| | MATERIAL NUMBER | CATALOG NUMBER |
| 10 | 0211010.XP | 211010BP |
| 15 | 0211015.XP | 211015BP |
| 20 | 0211020.XP | 211020BP |
| 25 | 0211025.XP | 211025BP |
| 30 | 0211030.XP | 211030BP |

ATO® Circuit Breakers Series - Type I Automatic Reset

Circuit breakers and fuses are a cost-effective solution to protecting wiring, equipment and subsystems. Terminals are grooved so that they can be easily snapped off with pliers to fit the electrical blocks of different vehicles. Use as is (long terminals) for Kenworth trucks. Use with one segment snapped off each terminal for: Dodge trucks, Ford heavy trucks, Navistar trucks. Use with two segments snapped off (short terminals) for Ford pickup trucks.

Color-coded housings with rating marked on the top: 10A red, 15A blue, 20A yellow, 25A silver, 30A green.



Long terminals, as supplied One segment snapped off Two segments snapped off

| CURRENT RATING (A) | PART NUMBERS | | | COLOR |
|--------------------|--------------|-------------|------------------|--------|
| | BULK | BOXED | RETAIL CLAMSHELL | |
| 10 | 30409-10 | 30409-10-BX | – | Red |
| 15 | 30409-15 | 30409-15-BX | – | Blue |
| 20 | 30409-20 | 30409-20-BX | 30409-20-BP | Yellow |
| 25 | 30409-25 | 30409-25-BX | – | Silver |
| 30 | 30409-30 | 30409-30-BX | 30409-30-BP | Green |

Fuse Blocks, Holders & Terminal Blocks



Fuse Holders accept fuses to provide electrical protection on circuits. In the following section, there is a wide range of fuse holders from lower current to higher current ratings and in various levels of sealing from moisture and dust. These are all single fuse products. For products accepting multiple fuses, refer to our Power Distribution Module (PDM) product offerings, in the next section of this catalog.

Where Do I Need a Fuse Holder?

Fuse holders allow you to install a fuse into an electrical circuit to protect the wiring from the harmful effects of excessive amount of electricity flowing through the cables. The fuse is a replaceable element that will 'blow' to stop the flow of an overload of electricity. If a fuse blows in a circuit, it is important to understand what caused the issue before replacing the fuse, otherwise there is a risk of repeated failures.

Fuses (in fuse holders) should be placed on every wire, as close to the point of the source of power (the battery) as possible. Every time a wire is split or spliced into smaller wires, each of those should be fused. Single fuse holders protect a single wire. A fuse (holder) should be properly sized. Larger diameter wires require larger fuses and smaller diameter wires get smaller rated fuses. Refer to best practices for proper selection fuses for your system

Sealed or Unsealed

Depending where on the vehicle a fuse holder is placed, it may be wise to utilize sealed fuse holders. In all instances, it is wise to try to have the most amount of physical protection of the fuse/fuse holder combination that makes sense. Fuse holders may have simple coverings (to prevent accidental shorting), all the way to completely sealing the fuse and cable to provide protection from moisture and dust in the electrical system. The more exposure to impurities the more risk to the safe and efficient performance of the electrical system as these elements can cause corrosion, and even electrical faults and failures. Some environments however are protected and it may not be necessary to use a sealed fuse holder. Littelfuse offers a wide variety of fuse holders that range from open to fully sealed.



Bolt-Down Fuse Blocks



MEGA® Bolt-Down Fuse Block

Use with MEGA fuses up to 500A. Ideal for battery and alternator connections and other heavy gauge cables requiring ultra high current protection. Includes protective cover. Features interconnecting pins on side of fuse block for multiple block configurations. Includes M8 threaded studs and hex nuts with lock washers. Fuse not included. Additional information: littelfuse.com/298

| PART NUMBERS | | | VOLTAGE | AMPERAGE | HARDWARE MATERIAL | STUD TORQUE |
|--------------|------------|-------------|---------|----------|-------------------|-------------|
| BULK 70-PC | BULK 20-PC | BULK 10-PC | | | | |
| 02980900Z | 02980900S | 02980900TXN | 32V DC | 500A | Zinc-Plated Steel | 12-18 Nm |



MEGA® SN Series Assure-Latch™ Fuse Block

The SN Series is a high amperage in-line MEGA fuse block with sealed positive latching technology. The fuse holder base and cover are secured together with AssureLatch™ technology to form a water resistant and ignition protected assembly. Fuse not included. Additional information: littelfuse.com/SN

| PART NUMBERS | VOLTAGE | AMPERAGE | INGRESS | HARDWARE MATERIAL | STUD TORQUE | NOTES |
|--------------|---------|----------|--------------|-------------------|-------------|--------------------|
| 880014 | 32V DC | 500A | IP66 & IP69K | Tin-Plated Steel | 20 Nm | Ignition Protected |



Flex-MEGA® Fuse Block

For use with MEGA bolt-down fuses, up to 500A. The Flex holder offers a flexible cover, which allows cable entry from virtually any direction, large wire size, and ring terminal stack up. Busbars are available for multiple holder applications and a dovetail feature allows interlocking of multiple Flex-MIDI and Flex-MEGA fuse holders together for a power distribution block. Fuse not included. Additional information at: littelfuse.com/FLEX-MEGA

| PART NUMBERS | VOLTAGE | AMPERAGE | HARDWARE MATERIAL | STUD TORQUE | NOTES |
|---------------------|--------------------|-------------------|-------------------|------------------------|--------|
| 02981001ZXT | 32V DC | 500A | Zinc-Plated Steel | 12-18 Nm | 330 PC |
| 02981028HXFC-SS | 32V DC | 500A | Stainless Steel | 12-18 Nm | - |
| 02981028HXFC | 32V DC | 500A | Zinc-Plated Steel | 12-18 Nm | - |
| BUSBAR PART NUMBERS | DESCRIPTION | HARDWARE MATERIAL | STUD TORQUE | NOTES | |
| 882-839-2 | 2 Position Bus Bar | Tin-Plated Copper | - | For use 2 Fuse Holders | |
| 882-839-3 | 3 Position Bus Bar | Tin-Plated Copper | - | For use 3 Fuse Holders | |
| 882-839-4 | 4 Position Bus Bar | Tin-Plated Copper | - | For use 4 Fuse Holders | |
| 882-839-5 | 5 Position Bus Bar | Tin-Plated Copper | - | For use 5 Fuse Holders | |



MIDI® SN Series Assure-Latch™ Fuse Block

The SN Series is a high amperage in-line MEGA fuse block with sealed positive latching technology. The fuse holder base and cover are secured together with AssureLatch™ technology to form a water resistant and ignition protected assembly. Fuse not included. Additional information: littelfuse.com/SN

| PART NUMBERS | VOLTAGE | AMPERAGE | INGRESS | HARDWARE MATERIAL | STUD TORQUE | NOTES |
|--------------|---------|----------|--------------|-------------------|-------------|--------------------|
| 880015 | 32V DC | 200A | IP66 & IP69K | Tin-Plated Steel | 20 Nm | Ignition Protected |



Flex-MIDI® Fuse Block

For use with MIDI bolt-down fuses, up to 200A. The Flex holder offers a flexible cover, which allows cable entry from virtually any direction, large wire size, and ring terminal stack up. Busbars are available for multiple holder applications and a dovetail feature allows interlocking of multiple Flex-MIDI and Flex-MEGA fuse holders together for a power distribution block. Fuse not included. Additional information: littelfuse.com/FLEX-MIDI

| PART NUMBERS | VOLTAGE | AMPERAGE | HARDWARE MATERIAL | STUD TORQUE | NOTES |
|---------------------|--------------------|-------------------|-------------------|------------------------|-----------------------|
| 04981038HXFC | 32V DC | 200A | Zinc-Plated Steel | 3.0-5.0 Nm | - |
| 04982001ZXFC | 32V DC | 200A | Zinc-Plated Steel | 3.0-5.0 Nm | 2 Holders with Busbar |
| BUSBAR PART NUMBERS | DESCRIPTION | HARDWARE MATERIAL | STUD TORQUE | NOTES | |
| 882-267-002 | 2 Position Bus Bar | Tin-Plated Copper | - | For use 2 Fuse Holders | |
| 882-267-003 | 3 Position Bus Bar | Tin-Plated Copper | - | For use 3 Fuse Holders | |
| 882-267-004 | 4 Position Bus Bar | Tin-Plated Copper | - | For use 4 Fuse Holders | |
| 882-267-005 | 5 Position Bus Bar | Tin-Plated Copper | - | For use 5 Fuse Holders | |

In-Line Fuse Holders

2



MIDI® Compact In-line Fuse Holder

Designed for use with bolt-down MIDI style fuses. It can be conveniently installed directly in-line with the cables and no mounting required. The fuse holder is easy to shrinkwrap for environmental protection and the corners of the cover are curved so that shrinkwrap will not be split.

Download additional technical information at: littelfuse.com/498-IL

| PART NUMBERS | | DETAILS | AMPERAGE | HARDWARE MATERIAL |
|--------------|-------|-------------------|----------|-------------------|
| BULK | BOXED | | | |
| 04980921GXM5 | | Complete Assembly | 200A | Zinc-Plated Steel |



MIDI® In-line Fuse Holder

Use with MIDI fuses up to 200 amps. Includes protective cover. Features interconnecting pins on side of fuse block for multiple block configurations. Includes M5 threaded studs and hex nuts with lock washers. Fuse not included.

Download additional technical information at: littelfuse.com/498

| PART NUMBERS | | | DETAILS | AMPERAGE | HARDWARE MATERIAL |
|--------------|------------|-------------|--|----------|-------------------|
| BULK 10-PC | BULK 20-PC | BULK 330-PC | | | |
| 0498900.TXN | 04980900S | 04980900ZXT | Complete Assembly | 200A | Zinc-Plated Steel |
| - | - | 04980903ZXT | Holder with mounting brackets | 200A | Zinc-Plated Steel |
| - | - | 04980904ZXT | Includes protective cover, threaded M5 studs, split washers, and hexnuts | 200A | Zinc-Plated Steel |

MAXI In-line Blade Fuse Holders with Covers - MAH Series

Use with MAXI Fuse up to 60 amps. Supplied with two 6" wire leads of 6 gauge black wire. Includes protective cover for harsh environment and mounting hole for easy firewall installation.

Download additional technical information at: littelfuse.com/MAH



| BOXED PART NUMBERS | | DETAILS | AMPERAGE | INGRESS | WIRE DETAILS | | | COVER |
|--------------------|----------------|----------|-----------|---------|--------------|--------|-------|-------|
| MATERIAL NUMBER | CATALOG NUMBER | | | | GAUGE | LENGTH | COLOR | |
| MAHC0001ZXJ | MAH1 | Standard | up to 60A | IP67 | 6 | 5" | Black | • |
| MAHC0001ZXJA | MAH1 | Standard | up to 60A | IP67 | 6 | 5" | Red | • |
| MAHC0001TXJ | MAH1 | Standard | up to 60A | IP67 | 6 | 5" | Black | • |

* Please inquire about additional bulk quantities

MAXI In-line Blade Splash Resistant Fuse Holders with Covers - 152 Series

The In-line Splash Resistant Fuse Holder provides an efficient, simple installation method for MAXI fuse applications in harsh under-the-hood environments

Download additional technical information at: littelfuse.com/152



| PART NUMBERS | | DETAILS | AMPERAGE | INGRESS | KIT CONTENTS | | |
|----------------|-------|------------------------------|----------|---------|--------------|-----------|-------|
| BULK | BOXED | | | | SEALS | TERMINALS | COVER |
| 01520003TXN941 | | for 4-6mm ² wire | 60A | IP54 | • | • | • |
| 01520003TXN942 | | for 6-10mm ² wire | 60A | IP54 | • | • | • |
| 01520005Z | | Body with tabs | 60A | IP54 | | • | • |
| 01520006Z | | Body without tabs | 60A | IP54 | | • | • |

MAXI In-line Fuse Holders with Optional Covers - MAB Series

Use with MAXI fuses up to 60 amps. Safe/easy replacement for hard to replace fusible link wire. Perfect for high amp audio applications. Interlocking block feature permits two pole position installation. Contains screw terminals. Optional dust cover available (Part Number: 01520007Z).

Download additional technical information at: littelfuse.com/MAB



| PART NUMBERS | | | DETAILS | AMPERAGE | COVER |
|--------------|-----------|------------|----------|-----------|-----------------|
| BULK | BOXED | CARDED | | | |
| 0MAB0001S | 0MAB0001F | 0MAB0001XP | High Amp | up to 60A | Sold Separately |

In-Line Blade Fuse Holders

MINI® In-line Blade Fuse Holders with Covers - FHM Series

Use with MINI 2 to 20A fuses. Supplied with two 4" wire leads of 14 gauge black wire. Includes protective cover for harsh environment. Heavy Duty MINI® In-line Blade Fuse Holders with Covers - FHM Series: Use with MINI 25 and 30A fuses. Supplied with two 4" wire leads of 12 gauge orange wire. Includes protective cover for harsh environment.

Download additional technical information at: littelfuse.com/FHM

| PART NUMBERS | | | DETAILS | AMPERAGE | INGRESS | WIRE DETAILS | | | COVER |
|--------------|-----------------|----------------|------------|----------|---------|--------------|--------|--------|-------|
| BULK 20-PC | CARDED | | | | | GAUGE | LENGTH | COLOR | |
| | MATERIAL NUMBER | CATALOG NUMBER | | | | | | | |
| 0FHM0001SXJ | 0FHM0001XP | FHM1BP | Standard | 2-20A | IP67 | 14 | 4" | Black | • |
| 0FHM0002SXJ | 0FHM0002XP | FHM2BP | Heavy Duty | 25-30A | IP67 | 12 | 4" | Orange | • |
| - | 0FHM0001XPGLO | 20-1020 | Smart Glow | - | IP67 | - | 4" | Red | • |

* Please inquire about additional bulk quantities

ATO® In-line Blade Fuse Holders with Covers - FHAC Series

Use with ATO 1 to 20A fuses. Supplied with two 3.5" wire leads of 16 gauge black wire. Includes protective cover for harsh environment. Heavy Duty ATO® In-line Blade Fuse Holders with Covers - FHAC Series: Use with ATO 25 and 30A fuses for air conditioner or other heavy duty applications. Supplied with two 3.5" wire leads of 12 gauge orange wire. Includes protective cover for harsh environment.

Download additional technical information at: littelfuse.com/FHAC

| PART NUMBERS | | | DETAILS | AMPERAGE | INGRESS | WIRE DETAILS | | | COVER |
|--------------|-----------------|----------------|------------|----------|---------|--------------|--------|--------|-------|
| BULK 20-PC | CARDED | | | | | GAUGE | LENGTH | COLOR | |
| | MATERIAL NUMBER | CATALOG NUMBER | | | | | | | |
| FHAC0001SXJ | FHAC0001XP | FHAC1BP | Standard | 2-20A | IP67 | 16 | 3.5" | Black | • |
| FHAC0002SXJ | FHAC0002XP | FHAC2BP | Heavy Duty | 25-30A | IP67 | 12 | 3.5" | Orange | • |

* Please inquire about additional bulk quantities

ATO® In-line Blade Fuse Holders - FHA Series

Use with ATO 1 to 20A fuses. Supplied with two 4" wire leads of 16 gauge black wire. Heavy Duty ATO® In-line Blade Fuse Holders - FHA Series: Use with ATO 25 and 30A fuses for air conditioner or other heavy duty applications. Supplied with two 4" wire leads of 12 gauge orange wire. FHA30BP includes 30 amp fuse.

Download additional technical information at: littelfuse.com/FHA

| PART NUMBERS | | | | | DETAILS | AMPERAGE | WIRE DETAILS | | |
|--------------|-----------------|----------------|-----------------|----------------|--------------------------|----------|--------------|--------|--------|
| BULK 20-PC | CARDED | | BOXED | | | | GAUGE | LENGTH | COLOR |
| | MATERIAL NUMBER | CATALOG NUMBER | MATERIAL NUMBER | CATALOG NUMBER | | | | | |
| 0FHA0001SXJ | 0FHA0001XP | FHA1BP | - | - | Standard | 1-20A | 16 | 4" | Black |
| 0FHA0002SXJ | 0FHA0002XP | FHA2BP | - | - | Heavy Duty | 25-30A | 12 | 4" | Orange |
| - | 0FHA0030XP | FHA30BP | 0FHA0030Z | FHA30 | Heavy Duty with 30A Fuse | 25-30A | 12 | 4" | Orange |
| - | 0FHA0001XPGLO | 20-1010 | - | - | Smart Glow | - | - | 4" | Red |

* Please inquire about additional bulk quantities

ATO® In-line Panel Mount Blade Fuse Holders - AFH and 155 Series

Versatile fuse holder for in-line or snap mount panel applications. Interlock body design allows fuse holders to be snapped together. Supplied with 8" loop of 14 gauge black wire. Heavy Duty ATO® In-line Panel Mount Blade Fuse Holders - AFH and 155 Series: Use with ATO 25 and 30A fuses. Supplied with 8" loop of 10 gauge orange wire.

Download additional technical information at: littelfuse.com/AFH

| PART NUMBERS | | | | DETAILS | AMPERAGE | WIRE DETAILS | | |
|-----------------|----------------|-----------------|----------------|------------|----------|--------------|---------|--------|
| BOXED | | CARDED | | | | GAUGE | LENGTH | COLOR |
| MATERIAL NUMBER | CATALOG NUMBER | MATERIAL NUMBER | CATALOG NUMBER | | | | | |
| 0AFH0001Z | AFH1 | 0AFH0001XP | AFH1BP | Standard | 1-20A | 14 | 8" loop | Black |
| - | - | 0AFH0002XP | AFH2BP | Heavy Duty | 25-30A | 10 | 8" loop | Orange |
| 01550300Z | 155300 | - | - | Standard | 20A | 14 | 8" loop | Black |

* Please inquire about additional bulk quantities



SMART GLOW Fuses



SMART GLOW Fuses



JCASE & Glass Fuse Holders

2

JCASE® In-line Cartridge Fuse Holders - FHJC & FHJ Series

In-line fuse holders for JCASE fuses available with brackets covers or wire sizes 10AWG (up to 40A) or 8AWG (up to 60A). Additional information: littelfuse.com/FHJC



| PART NUMBERS | | DETAILS | AMPERAGE | INGRESS | WIRE DETAILS | | | BRACKET | COVER |
|--------------|------------|------------|-----------|---------|--------------|--------|-------|---------|-------|
| BULK 250-PC | BULK 50-PC | | | | GAUGE | LENGTH | COLOR | | |
| FHJC1001G | – | Standard | up to 40A | IP67 | 10AWG | 4" | Red | – | • |
| FHJC1002G | FHJC1002L | Heavy Duty | up to 60A | IP67 | 8AWG | 4" | Red | – | • |
| FHJC2002G | FHJC2002L | Heavy Duty | up to 60A | IP67 | 8AWG | 4" | Red | • | • |
| 0FHJ1001G | – | Standard | up to 40A | – | 10AWG | 4" | Red | – | – |
| 0FHJ1002G | – | Heavy Duty | up to 60A | – | 8AWG | 4" | Red | – | – |
| 0FHJ2001G | – | Standard | up to 40A | – | 10AWG | 4" | Red | • | – |
| 0FHJ2002G | – | Heavy Duty | up to 60A | – | 8AWG | 4" | Red | • | – |

* Please inquire about additional bulk quantities

Glass Fuse In-line Twist-Lock Fuse Holders • FNY Series

Constructed of weather resistant nylon. Simple "twist-lock" allows easy fuse removal and replacement. Supplied with 8" loop of 14 gauge black wire and one spring. Use with Glass SFE 4, 6, 71/2, 9, 14, 20, AGA, AGC, AGW and AGX Fuses up to 20 amps. Additional information: littelfuse.com/FNY



| CARDED PART NUMBERS | | DETAILS | AMPERAGE | WIRE DETAILS | | |
|---------------------|---------|-------------|-----------|--------------|---------|-------|
| MATERIAL | CATALOG | | | GAUGE | LENGTH | COLOR |
| 0FNY0001XP | FNY1BP | Holder Only | up to 20A | 14 | 8" loop | Black |

* Please inquire about additional bulk quantities

Glass Fuse In-line Heavy Duty Fuse Holders • FNY Series

Spring loaded heavy duty glass fuse holder includes AGC 20A or 30A fuse for GM air conditioner, heater blower motors or other heavy duty applications. Supplied with two 4" wire leads of 12 gauge orange wire. FNY20BP includes 20A fuse, FNY30BP includes 30A fuse. Additional information: littelfuse.com/FNY



| CARDED PART NUMBERS | | DETAILS | AMPERAGE | WIRE DETAILS | | |
|---------------------|---------|---------------|----------|--------------|--------|--------|
| MATERIAL | CATALOG | | | GAUGE | LENGTH | COLOR |
| 0FNY0020XP | FNY20BP | With 20A Fuse | 20A | 12 | 4" | Orange |
| 0FNY0030XP | FNY30BP | With 30A Fuse | 30A | 12 | 4" | Orange |

Glass Fuse In-line Bayonet Knob Fuse Holders • FHP Series

Constructed of tough black thermoset (UL94V0). Includes 3 springs for various fuse sizes and spring-locked, bayonet type knob. Supplied with 15" loop of 14 gauge red wire. Use with Glass SFE 71/2, 9, 14, 20, AGA, AGC, AGW and AGX Fuses up to 20 amps. Additional information: littelfuse.com/FHP



| BOXED PART NUMBERS | | DETAILS | AMPERAGE | WIRE DETAILS | | |
|--------------------|---------|-------------|-----------|--------------|----------|-------|
| MATERIAL | CATALOG | | | GAUGE | LENGTH | COLOR |
| 0FHP0001Z | FHP1 | Holder Only | up to 20A | 14 | 15" loop | Red |

Glass Fuse In-line Fuse Holders

Holders accept SFE and AGC fuses through 30A. Supplied with wire loop which can be cut and spliced. Holder twist-locks the fuse in place. Available with the fuse. Additional information: littelfuse.com/3031



| PART NUMBERS | | | DETAILS | AMPERAGE | WIRE DETAILS | | |
|--------------|------------|------------|---------------|-----------|--------------|---------|-------|
| BULK | BOXED | RETAIL | | | GAUGE | LENGTH | COLOR |
| 3031-0 | 3031-0-BX | 3031-0-BP | Holder Only | up to 30A | 14 | 8" loop | Black |
| 3031-20 | 3031-20-BX | 3031-20-BP | With 20A Fuse | 20A | 14 | 8" loop | Black |
| 3031-30 | 3031-30-BX | – | With 30A Fuse | 30A | 14 | 8" loop | Black |

3AG Shock-Safe Panel Mount Fuse Holders

Designed to eliminate the possibility of electrical shock, as defined in IEC standards 65 and 257. Shock-Safe fuse holders feature a low profile body, finger-grip knob and anti-tease feature that eliminates circuit interruption when knob is accidentally depressed.



| CARDED MATERIAL NUMBER | VOLTAGE | AMPERAGE | TERMINALS |
|------------------------|---------|----------|------------------------------------|
| 03453LF2XP | 250V | 20A | ¼" straight NEMA/DIN quick connect |

Add-A-Circuit® & Power Feed



ATO® Add-A-Circuit®

Allows easy installation of additional circuits without cutting or splicing. Turns one fuse slot into two while providing protection for both circuits. Maintains new car warranty. Use with ATO Fuses up to 10 amps. Carded Kit Part Numbers include ATO 3, 5, 7.5 and 10 amp fuses.

| BULK PART NUMBERS | | CARDED KIT PART NUMBERS | |
|-------------------|----------------|-------------------------|----------------|
| MATERIAL NUMBER | CATALOG NUMBER | MATERIAL NUMBER | CATALOG NUMBER |
| 0FHA0200Z | FHA200 | 0FHA0200ZP | FHA200BP |



MINI® Add-A-Circuit®

Same as ATO Add-A-Circuit except for use with MINI Fuses up to 10 amps. Carded Kit Part Numbers include MINI 3, 5, 7.5 and 10 amp fuses.

| BULK PART NUMBERS | | CARDED KIT PART NUMBERS | |
|-------------------|----------------|-------------------------|----------------|
| MATERIAL NUMBER | CATALOG NUMBER | MATERIAL NUMBER | CATALOG NUMBER |
| 0FHM0200Z | FHM200 | 0FHM0200ZP | FHM200BP |



LP MINI® Add-A-Circuit®

Same as ATO Add-A-Circuit except for use with LPMINI Fuses up to 10 amps. Carded Kit Part Numbers include LPMINI 3, 5, 7.5 and 10 amp fuses.

| BULK PART NUMBERS | CARDED KIT PART NUMBERS |
|-------------------|-------------------------|
| MATERIAL NUMBER | MATERIAL NUMBER |
| FHLM0200Z | FHLM0200ZPA |



MICRO2® Add-A-Circuit®

Same as ATO Add-A-Circuit except for use with MICRO2 Fuses up to 10 amps. Carded Kit Part Numbers include MICRO2 3, 5, 7.5 and 10 amp fuses.

| BULK PART NUMBERS | CARDED KIT PART NUMBERS |
|-------------------|-------------------------|
| MATERIAL NUMBER | MATERIAL NUMBER |
| FHM20200Z | FHM20200ZPA |



Battery Power Feed Kit

Attaches directly to battery terminal. Allows the addition of up to 3 circuits. Includes MINI fuse in-line fuse holder with protective cap. Also can be used as a frame ground. Constructed of durable brass for optimal conductivity..

| CARDED PART NUMBERS | |
|---------------------|----------------|
| MATERIAL NUMBER | CATALOG NUMBER |
| 0BPF0001ZP | BPF1BP |

Caution: Fusetaps are not a recommended alternative for adding circuits because they can stress the terminals in the fuse block. This situation can create a loose fitting fuse, which in turn produces excessive heat, which can cause nuisance blows, even melting of the fuse and fuse block and possibly an expensive repair in the future. When a fusetap is used, in many cases there is no fuse protecting the new circuit, a condition which can also present a hazard.

Fuse Pullers and Battery Accessories

2



Fuse Tester and Puller

Conveniently and easily tests ATO and MINI blade fuses either in or out of the fuse block, with or without vehicle battery power. Indicator light on tester glows bright green when fuse is good. Fuse puller end allows for easy fuse removal and replacement. 24V maximum.

Fuse Pullers

Fuse puller allows for easy fuse removal and replacement.



| BOXED PART NUMBERS | | CARDED PART NUMBERS | | DESCRIPTION |
|--------------------|----------------|---------------------|----------------|---|
| MATERIAL NUMBER | CATALOG NUMBER | MATERIAL NUMBER | CATALOG NUMBER | |
| 00970019X | 097019 | 00970019XP | 097019BP | ATO & MINI Fuse Puller / Tester |
| - | 097023 | 00970023XP | 097023BP | Tri-Puller™ – Glass Fuses, Ceramic Type Fuses, ATO and MINI Blade Fuse Puller |
| - | 097026 | 00970026XP | 097026BP | MAXI Blade Fuse Puller |
| - | 097038 | 00970038XPA | - | ATO and MINI Fuse Puller |
| - | - | 00970053XP | - | JCASE Fuse Puller |
| - | - | 00970025XPA | - | MICRO2 / MICRO3 Fuse Puller |
| - | - | 00970054XPA | - | MCASE Fuse Puller |



Anti-Theft Battery Master Switch

- Available in two versions, Fused and Detachable.
- Fused version maintains current to all electrical circuits such as the alarm, on-board computer, central locking system and radio memory presets.
- Detachable version features a special disconnect that allows the battery to easily be removed for anti-theft protection. Perfect for seasonal storage needs or easy off vehicle battery charging for Autos, Motorcycles, RV's, Boats, etc.
- Generate sales with the lowest cost anti-theft devices available on the market today.
- A simple turn of the knob isolates the battery and makes the vehicle unable to start.
- Makes anti-theft protection affordable when compared to expensive alarm systems.
- Eliminates complicated installation — no special electrical or mechanical expertise required.
- Fits all standard Top Mount Post batteries. Can be used with Side Mount Post batteries by using a Top Mount Adapter Post (not included).
- Works on 12 to 24 volt systems up to 135 amperes.

| CARDED PART NUMBERS | | DESCRIPTION |
|---------------------|----------------|--|
| MATERIAL NUMBER | CATALOG NUMBER | |
| 0ATD0300ZBP | ATD300BP | Anti-theft Battery Master Switch – Fused |

Multiple Position Fuse Blocks

BMZ Series • Battery Mount ZCASE® Fuse Holder

The BMZ fuse holder allows you to mount fusing directly to a post style battery without any special hardware. The isolated bolts eliminate the traditional need for nylon nuts and fuses can be assembled using standard M8 threaded hardware.

- Max Continuous Current: 275A
- Mounts directly to a post style of battery
- Available in 2 or 3 outputs
- Fusing directly at the battery allows location of larger power distribution boxes outside of the engine compartment while assuring protection of the supply cable

Download additional technical information at: littelfuse.com/BMZ



| PART NUMBERS | | | POSITIONS | DESCRIPTION |
|--------------|--------------|--------|-----------|---|
| BULK | BOXED | RETAIL | | |
| 882-854 | – | – | 2 | 2 Way Bus Bar & Stud Assembly |
| 882-853 | – | – | 3 | 3 Way Bus Bar & Stud Assembly |
| 876-199 | – | – | – | Battery Terminal |
| 901-325 | – | – | – | Red Rubber 2 or 3 Way Cover |
| – | 0FHZ00854-BX | – | 2 | Kit: 882-854 (2 way bus bar), 876-199 (terminal mount), 901-325 (red cover), 1X M8 Bolt, 3x M8 Nuts |
| – | 0FHZ00853-BX | – | 3 | Kit: 882-853 (3 way bus bar), 876-199 (terminal mount), 901-325 (red cover), 3x M8 Nuts |

SMZ Series • Stud Mount ZCASE® Fuse Holder

The SMZ stud mount fuse holder allows you to mount fusing directly to a M8 or M10 stud on applications such as batteries, alternators, battery switches or electrical relays.

- Mounts directly to a M10 or M8 stud
- Uses high amp ZCASE fuses, (M8) available 40-600A
- Tin plate coating on the busbar ensures corrosion resistance

Download additional technical information at: littelfuse.com/SMZ



| PART NUMBERS | MOUNTING SIZE | FUSE TERMINAL NUT (M8) | DETAILS |
|--------------|---------------|------------------------|-------------------------|
| 0FHZ0201Z | M8 (8.5mm) | • | 901-525 Fuse/Stud Cover |
| 0FHZ0202Z | M8 (8.5mm) | • | 901-524 Fuse Cover |
| 0FHZ0211Z | M10 (10.5mm) | • | 901-525 Fuse/Stud Cover |
| 0FHZ0212Z | M10 (10.5mm) | • | 901-524 Fuse Cover |

ATO® Fuse Blocks with Common Feed

Multi-position black thermoplastic fuse block for ATO fuses. Contacts are recessed for additional safety and a recession in the center of the block accepts a label.

- Common hot feed – stud terminal is 10-32 with hexnut, flat washer and lockwasher
- Blade terminals are .25" wide (6.4mm)
- Four .218" (5.5mm) diameter mounting holes take #10 screws
- Size: 3.375" wide x .812" high (85.7 x 20.6mm)
- Mounting holes 1.06" (27.0mm) on centers, widthwise.

Download additional technical information at: littelfuse.com/Fuseholders



| PART NUMBERS | | | VOLTAGE | MAX CONTINUOUS CURRENT | MAX FUSE RATING PER CIRCUIT | FUSE POSITIONS | DIMENSIONS | MOUNTING HOLES ON CENTERS |
|--------------|-------------|------------|-----------|------------------------|-----------------------------|----------------|---------------------------|---------------------------|
| BULK | BOXED | RETAIL | | | | | | |
| 46377-6 | 46377-6-BX | 46377-6-BP | 12-24V DC | 150A | 25A | 6 | 2.47"L x 3.375"W x .812"H | .625" |
| 46377-8 | 46377-8-BX | – | 12-24V DC | 150A | 25A | 8 | 3.09"L x 3.375"W x .812"H | 1.25" |
| 46377-10 | 46377-10-BX | – | 12-24V DC | 150A | 25A | 10 | 3.72"L x 3.375"W x .812"H | 1.875" |
| 46377-12 | 46377-12-BX | – | 12-24V DC | 150A | 25A | 12 | 4.34"L x 3.375"W x .812"H | 2.5" |
| 46377-18 | 46377-18-BX | – | 12-24V DC | 150A | 25A | 18 | 6.22"L x 3.375"W x .812"H | 4.375" |
| 46379-6 | 46379-6-BX | – | 12-24V DC | 150A | 25A | 6 | – | – |
| 46379-8 | 46379-8-BX | – | 12-24V DC | 150A | 25A | 8 | – | – |

Multiple Position Glass Fuse Blocks

2



ATO® Fuse Blocks with 1/4" Quick Connect Terminals

Use with ATO fuses up to 15 amps. Available in 5 pole unit with removable clear protective cover. Available in side or bottom positioned 1/4" Q.C. terminal configurations. Unit with bottom Q.C. terminals includes detachable side mounting brackets.

Download additional technical information at: littelfuse.com/Fuseholders

| PART NUMBERS | | | DETAILS | AMPERAGE | PROTECTIVE COVER |
|--------------|------------|----------------|--|----------|------------------|
| BULK 10-PC | CARDED | CATALOG NUMBER | | | |
| 03500417TXN | 03500417XP | 350417BP | 1/4" Q.C. side position | 2-20A | • |
| 03500418TXN | 03500418XP | 350418BP | 1/4" Q.C. bottom position (includes mounting brackets) | 25-30A | • |

* Please inquire about additional bulk quantities

Omni-Blok® Fuse Blocks with 1/4" Quick Connect Terminals

For 1/4" x 1-1/4" glass fuses. Available in one through twelve pole units. Units may be easily broken apart as needed to obtain the desired number of poles. Rated at 20A, 300 V

Download additional technical information at: littelfuse.com/Fuseholders



| PART NUMBERS | | POLES | VOLTAGE | AMP |
|--------------|------------|-------|---------|-----|
| BULK | CARDED | | | |
| 03540801ZXGY | — | 1 | 300V | 20A |
| 03540802ZXGY | 00MN0002XP | 2 | 300V | 20A |
| 03540804ZXGY | 00MN0004XP | 4 | 300V | 20A |

Common Hot Feed Glass Fuse Block

Fiber base with 11/64" (4.4mm) diameter mounting holes. Solid brass busbar, phosphor-bronze fuse clips. Brass terminals and screws.

Download additional technical information at: littelfuse.com/Fuseholders



| PART NUMBERS | | | MAX FUSE RATING PER CIRCUIT | FUZE POSITIONS | DIMENSIONS | BUSBAR |
|--------------|-------------|-------------|-----------------------------|----------------|--------------------------|--------|
| BULK | BOXED | RETAIL | | | | |
| M-414-01 | — | M-414-01-BP | 20A | 4 | 2.75"L x 2.24"W x .625"H | • |
| M-415-01 | — | — | 20A | 5 | 3.50"L x 2.24"W x .625"H | • |
| M-641-01 | M-641-01-BX | M-641-01-BP | 20A | 6 | 4.25"L x 2.24"W x .625"H | • |
| M-643-01 | M-643-01-BX | M-643-01-BP | 20A | 8 | 5.75"L x 2.24"W x .625"H | • |
| — | — | — | 20A | 12 | 8.75"L x 2.24"W x .625"H | • |

M-674 • Combination Glass Fuse Block and Terminal Block

Combination Fuse Block & Terminal Block For SFE 20A or 3AG (AGC) fuses. Common hot feed to four independently-fused circuits, and common ground strip for four circuits. Solid brass busbars, terminals and terminal screws. Nickel-plated phosphor-bronze fuse clips. Two eyelet holes for mounting with 3/16" (4.8mm) screws, 2.25" (57.2mm) on centers.

Download additional technical information at: littelfuse.com/Fuseholders



| PART NUMBERS | | | MAX FUSE RATING PER CIRCUIT | FUZE POSITIONS | DIMENSIONS | BUSBAR |
|--------------|----------|----------|-----------------------------|----------------|--------------------------|--------|
| BULK | BOXED | RETAIL | | | | |
| — | M-674-BX | M-674-BP | 20A | 4 | 3.50"L x 2.75"W x .781"H | • |

Laminated Base Fuse Block with Screw Terminals

For 1/4" x 1-1/4" glass fuses. Available in one through twelve pole units. Rated at 20A, 300V.

Download additional technical information at: littelfuse.com/Fuseholders



| PART NUMBERS | | | | | PART NUMBERS | | | | |
|--------------|-------|-------|---------|-----|--------------|-------|-------|---------|-----|
| BULK | BOXED | POLES | VOLTAGE | AMP | BULK | BOXED | POLES | VOLTAGE | AMP |
| 03560001Z | — | 1 | 300V | 20A | 03560009Z | — | 9 | 300V | 20A |
| 03560002Z | — | 2 | 300V | 20A | 03560010Z | — | 10 | 300V | 20A |
| 03560004Z | — | 4 | 300V | 20A | 03560011Z | — | 11 | 300V | 20A |
| 03560006Z | — | 6 | 300V | 20A | 03560012Z | — | 12 | 300V | 20A |

Terminal Blocks



M-42X Individual Feed Screw Terminal Blocks

Moisture-resistant molded Bakelite insulator base with barrier strips. Nickel-plated brass terminal links and 8-32 binding head screws.

Download additional technical information at: littelfuse.com/TerminalBlocks

| PART NUMBERS | | | NUMBER OF POSITIONS | TERMINALS | | DIMENSIONS | MOUNTING HOLE DIMENSION |
|--------------|----------|----------|---------------------|---------------------|------|-------------------------|----------------------------|
| BULK | BOXED | RETAIL | | MATERIAL | SIZE | | |
| M-426 | M-426-BX | M-426-BP | 4 | Nickel-Plated Brass | 8-32 | 3.22"L x 1.31"W x .67"H | 2.81" (71.4mm) on centers |
| M-427 | M-427-BX | M-427-BP | 6 | Nickel-Plated Brass | 8-32 | 4.33"L x 1.31"W x .67"H | 3.93" (99.9mm) on centers |
| M-428 | M-428-BX | M-428-BP | 8 | Nickel-Plated Brass | 8-32 | 5.46"L x 1.31"W x .67"H | 5.06" (128.5mm) on centers |
| M-429 | M-429-BX | M-429-BP | 10 | Nickel-Plated Brass | 8-32 | 6.59"L x 1.31"W x .67"H | 6.19" (157.2mm) on centers |
| M-456 | M-456-BX | - | 14 | Nickel-Plated Brass | 8-32 | 8.84"L x 1.31"W x .67"H | 8.44" (214.4mm) on centers |



4721 Individual Feed Stud Terminal Blocks

Moisture-repellent phenolic insulator base with brass stud terminals. Hexnuts, flat washers and lockwashers included. Two mounting holes accept 3/16" (4.8mm) screws (not included).

Download additional technical information at: littelfuse.com/TerminalBlocks

| PART NUMBERS | | | NUMBER OF POSITIONS | TERMINALS | | DIMENSIONS | MOUNTING HOLE DIMENSION |
|--------------|-------------|--------|---------------------|-----------|-------|----------------------------|----------------------------|
| BULK | BOXED | RETAIL | | MATERIAL | SIZE | | |
| 4721-P2 | 4721-P2-BX | - | 2 | Brass | 10-32 | 2.68"L x .5/8"W x 27/32"H | 1.87" (47.5mm) on centers |
| 4721-P3 | 4721-P3-BX | - | 3 | Brass | 10-32 | 3.25"L x .5/8"W x 27/32"H | 2.50" (63.5mm) on centers |
| 4721-P4 | 4721-P4-BX | - | 4 | Brass | 10-32 | 3.87"L x .5/8"W x 27/32"H | 3.12" (79.2mm) on centers |
| 4721-P5 | 4721-P5-BX | - | 5 | Brass | 10-32 | 4.5"L x .5/8"W x 27/32"H | 3.75" (95.3mm) on centers |
| 4721-P6 | 4721-P6-BX | - | 6 | Brass | 10-32 | 5.12"L x .5/8"W x 27/32"H | 4.38" (111.3mm) on centers |
| 4721-P8 | 4721-P8-BX | - | 8 | Brass | 10-32 | 6.37"L x .5/8"W x 27/32"H | 5.62" (142.7mm) on centers |
| 4721-P10 | 4721-P10-BX | - | 10 | Brass | 10-32 | 7.62"L x .5/8"W x 27/32"H | 6.87" (174.5mm) on centers |
| 4721-P12 | 4721-P12-BX | - | 12 | Brass | 10-32 | 8.87"L x .5/8"W x 27/32"H | 8.12" (206.2mm) on centers |
| 4721-P14 | 4721-P14-BX | - | 14 | Brass | 10-32 | 10.12"L x .5/8"W x 27/32"H | 9.37" (238.0mm) on centers |



4758 & 4755 Individual Feed Stud Terminal Blocks

Moisture-repellent molded insulator base with barrier strips. Two mounting holes accept 1/4" (6.3mm) screws. Hardware sold separately.

Download additional technical information at: littelfuse.com/TerminalBlocks

| PART NUMBERS | | | NUMBER OF POSITIONS | TERMINALS | | DIMENSIONS | MOUNTING HOLE DIMENSION |
|--------------|---------|--------|---------------------|-----------|-------|---------------------------|---------------------------|
| BULK | BOXED | RETAIL | | MATERIAL | SIZE | | |
| 4758 | 4758-BX | - | 4 | Steel | 10-24 | 4.5"L x .5/8"W x 27/32"H | 3.75" (95.3mm) on centers |
| 4755 | 4755-BX | - | 5 | Steel | 10-24 | 5.25"L x .5/8"W x 27/32"H | 4.5" (114.3mm) on centers |

Terminal Blocks

2



M-449 & M-448 Common Busbar Terminal Blocks

Moisture-resistant molded thermoplastic insulator base with solid brass busbar that safely carries up to 50A. Two 1/4-20 brass studs with hexnuts. 8-32 round head screws for attachment of wires. Two mounting holes accept No. 10 countersink flathead screws that are 5.19" (131.5mm) on center for 10-gang version, and 8.31 (211.07mm) on center for 20-gang versions.

Download additional technical information at: littelfuse.com/TerminalBlocks

| PART NUMBERS | | | NUMBER OF POSITIONS | TERMINALS | | DIMENSIONS | BUSBAR |
|--------------|----------|----------|---------------------|------------------|------|----------------------------|--------|
| BULK | BOXED | RETAIL | | MATERIAL | SIZE | | |
| M-449 | M-449-BX | M-449-BP | 10 | Brass | 8-32 | 5.75"L x 1.25"W x 1.031"H | • |
| M-448 | M-448-BX | – | 20 | Brass | 8-32 | 5.75"L x 1.25"W x 1.031"H | • |
| M-448-02 | – | – | 20 | Tin-Plated Brass | 8-32 | 8.875"L x 1.25"W x 1.031"H | • |

46206-04 Common Busbar Terminal Blocks



Moisture-repellent thermoset plastic insulator base with 3/16" (4.76mm) diameter mounting holes. Eyelets are 3.125" (79.4mm) on centers.

Download additional technical information at: littelfuse.com/TerminalBlocks

| PART NUMBERS | | | NUMBER OF POSITIONS | TERMINALS | | DIMENSIONS | BUSBAR |
|--------------|-------------|--------|---------------------|-----------|-------|---------------------------|--------|
| BULK | BOXED | RETAIL | | MATERIAL | SIZE | | |
| 46206-04 | 46206-04-BX | – | 4 | Brass | 10-32 | 3 7/8"L x 5/8"W x 27/32"H | • |

86099 Brass Busbars

Solid Brass busbar meant for mounting circuit protection including fuses and circuit breakers. Busbars tested to 70A with temperature rise no greater than 55°C.

Download additional technical information at: littelfuse.com/TerminalBlocks



| PART NUMBERS | | | NUMBER OF POSITIONS | MATERIAL | DIMENSIONS | MOUNTING HOLE DIMENSION |
|--------------|------------|--------|---------------------|----------|----------------------|---|
| BULK | BOXED | RETAIL | | | | |
| – | 86099-2-BX | – | 2 | Brass | 1.53" long (38.9mm) | .910" (23.1mm) on centers, .021" (5.3mm) diameter. |
| 86099-3 | 86099-3-BX | – | 3 | Brass | 2.43" long (61.7mm) | |
| 86099-4 | 86099-4-BX | – | 4 | Brass | 3.34" long (84.8mm) | |
| 86099-5 | 86099-5-BX | – | 5 | Brass | 4.24" long (107.7mm) | |

86126 Copper Busbars

Solid copper busbars meant for mounting circuit protection including fuses and circuit breakers.

Download additional technical information at: littelfuse.com/TerminalBlocks



| PART NUMBERS | | | NUMBER OF POSITIONS | MATERIAL | DIMENSIONS | MOUNTING HOLE DIMENSION |
|--------------|-------------|--------|---------------------|----------|------------------------------------|---------------------------------|
| BULK | BOXED | RETAIL | | | | |
| 86126-2 | 86126-2-BX | – | 2 | Copper | 1.41" x .560" (35.8 x 14.2mm) | .910" (23.1mm) on centers |
| 86126-4 | 86126-4-BX | – | 4 | Copper | 3.23" x .560" (82.1 x 14.2mm) | 2.73" (69.34mm) on centers |
| 86126-6 | 86126-6-BX | – | 6 | Copper | 5.05" x .560" (128.3 x 14.2mm) | 4.55" (115.57mm) on centers |
| 86126-8 | 86126-8-BX | – | 8 | Copper | 6.87" x .560" (174.5 x 14.2mm) | 6.37" (161.79mm) on centers |
| 86126-12 | 86126-12-BX | – | 12 | Copper | 10.51" x .560" (267.0 x 14.2mm) | 10.01" (254.25mm) on centers |

AFTERMARKET FUSE HOLDERS

COMPACT DESIGNS SAVE SPACE & REDUCE WIRE CONNECTIONS

SMZ SERIES STUD MOUNT ZCASE® FUSE HOLDER

The SMZ stud mount fuse holder allows you to mount fusing directly to a M8 or M10 stud on applications such as batteries, alternators, battery switches or electrical relays. The SMZ stud mount fuse holder features a compact design which saves space and eliminates the need to wire in a separate fuse holder or power distribution module.

Download additional technical information at: littelfuse.com/SMZ



Specifications

| | |
|--------------------------------|----------------------------------|
| Voltage Rating: | 80V DC or max rating of the fuse |
| Max Continuous Current: | 400A |
| Available Fuse Rating: | 40- 600A |
| Fuse Terminal Torque: | M8 Nut: 14 ± 2 Nm |
| Operating Temp: | -40° to 105° C |

| PART NUMBERS | DESCRIPTION |
|--------------|--|
| OFHZ0201Z | M8 SMZ Fuse Holder with Fuse and Stud Cover |
| OFHZ0202Z | M8 SMZ Fuse Holder with Fuse Cover |
| OFHZ0211Z | M10 SMZ Fuse Holder with Fuse and Stud Cover |
| OFHZ0212Z | M10 SMZ Fuse Holder with Fuse Cover |



BMZ SERIES BATTERY MOUNT ZCASE® FUSE HOLDER KITS

The BMZ battery post mount fuse holder allows you to mount fusing directly to a post style battery terminal. The BMZ series accepts the Littelfuse proprietary ZCASE fuse that is available in 40-600A ratings with similar characteristics to the MEGA® fuse. The BMZ post mount fuse holder mounts directly to the battery without any need for additional mounting hardware and is available in 2 or 3-pole versions.

Download additional technical information at: littelfuse.com/BMZ



Specifications

| | |
|---------------------------------|----------------------------------|
| Max Voltage Rating: | 32V DC or max rating of the fuse |
| Max Continuous Current: | 275A |
| Available Fuse Rating: | 40- 600A |
| Fuse Terminal Torque: | M8 Nut: 14 ± 2 Nm |
| Battery Terminal Torque: | 5.4 ± 0.9 Nm @ 540 RPM |
| Operating Temp: | -40° to 125° C |

| PART NUMBERS | DESCRIPTION |
|--------------|---|
| OFHZ00854-BX | Kit: 882-854 (2 way bus bar), 876-199 (terminal mount), 901-325 (red cover), 1X M8 Bolt, 3x M8 Nuts |
| OFHZ00853-BX | Kit: 882-853 (3 way bus bar), 876-199 (terminal mount), 901-325 (red cover), 3x M8 Nuts |



Power Distribution Modules



Power Distribution Modules (PDMs) are devices that accept electrical power from one or more wires (inputs) and then distribute it to multiple cables (outputs). The PDMs also accept power protection and control devices from one or more fuse, circuit breaker, relay, diode, or even solid state and electronic circuitry and distribute to multiple outputs.

Blade or Bolt-Down Fuse?

DC (automotive) fuses are offered in two basic forms: Blade or Bolt Down.

Blade & Cartridge fuses can be hand inserted into a fuse holder. These fuses provide protection for several amperage ratings up to 70A. They are well suited to protect smaller to medium diameter wires that are usually some distance from the battery. Single blade fuse holders are often called 'In-Line' fuse holders as they are spliced into the wiring. Remember to place the fuse holder as close to the battery and as far away from the load as possible, so that it protects the wire from a short anywhere along its length. Any short between the power source and the fuse is not protected. Littelfuse blade fuses include: MICRO2®, MICRO3®, MINI®, LP MINI®, ATO®, MAXI, MCASE®, MCASE+®, JCASE® and LP JCASE®.

Bolt Down fuses need to be secured to the fuse holder with a screw or nut/bolt. These fuses provide protection from 30A to 600A. They are well suited to protect medium to large diameter wires that are usually closer to the battery. Ring terminals are crimped onto cables that are connected to these holders and spliced into the wiring. Remember to place the fuse holder as close to the battery and as far away from the load as possible, so that it protects the wire from a short anywhere along its length. Any short between the power source and the fuse is not protected which is why you should have master fusing as close the battery as possible. Littelfuse bolt-down fuses include: MIDI®, MEGA®, CF8 and ZCASE®.

Also, there are still a wide variety of applications that use glass tube fuses. These are typically lower current values and are becoming less popular for most automotive applications due to their size, form factors, and lack of color coding.



Hard-Wired Boxes

HWB Series - Compact Sealed Hard-Wired Boxes for 2.8mm Style Fuses & Relays

The HWB series hard-wired boxes are sealed units that accept any 2.8mm style fuses, relays, circuit breakers or diodes depending on which HWB model is selected. The HWB series is the perfect fit for accessory circuits and overflow circuits from your main power distribution module.

The series features durable construction, IP67 & IP69K ratings, compact sizes, gasket sealed covers and multiple mounting types. See chart below for specific details. The HWB series eliminates the use of internal bussing allowing the user or design engineer to customize the circuitry utilizing direct wire-to-component connections. TPAs (terminal position assurance locks) give secondary locking protection of the wire leads, which aid in prevention of leads from being pulled out and snap onto the back after wires are installed.

- Accepts a combination of 2.8mm components – MINI® fuses, relays, circuit breakers or diodes. (sold separately)
- Cover tethers available to prevent loss of component during service.
- HWB60 series are modular and can be dovetailed together to expand circuit protection capacity. They can also be interlocked to other PDMs and fuse holders (FLEC Flexible Electrical Control Center and MEGA/MIDI Flex fuse holder)
- HWB60 and HWB18 series uses Delphi Metri-Pack 280 terminals, cable seals and cavity plugs. Download datasheet for specific details.
- HWB12 and HWB6 series are available with black or clear covers for easy component status identification.
- HWB12 and HWB6 series use TYCO MCP terminals, cable seals and cavity plugs. See datasheet for specific details.

Datasheet, 3D Models, 2D Prints and additional information: littelfuse.com/HWB



| SERIES | PART NUMBERS | | MAX CONTINUOUS CURRENT | MAX FUSE RATING PER CIRCUIT | NUMBER OF CAVITIES | MOUNTING TORQUE | INGRESS PROTECTION | DIMENSIONS | TERMINALS (sold separately) | | KIT CONTENTS | | | | |
|----------|--------------|--------|------------------------|-----------------------------|--------------------|-----------------|--------------------|-------------|-----------------------------|----------|--------------|-------------|--------|------|---------|
| | BULK | RETAIL | | | | | | | DELPHI METRI-PACK | TYCO MCP | COVER | AssureLatch | GASKET | TPAs | BRACKET |
| HWB60-AL | PDM71001ZXM | – | 250A | 30A | 60 | 4-6 Nm | IP67 & IP69K | 113x52x82mm | • | | Black | • | • | • | |
| HWB60-AL | PDM71003ZXM | – | 250A | 30A | 60 | 4-6 Nm | IP67 & IP69K | 113x52x82mm | • | | Black | • | • | • | |
| HWB60 | PDM21001LXM | – | 250A | 30A | 60 | 4-6 Nm | IP67 & IP69K | 113x52x82mm | • | | Black | | • | • | |
| HWB18 | PDM31001ZXM | – | 200A | 30A | 18 | 5.5-6.5 Nm | IP67 & IP69K | 60x38x74mm | • | | Black | | • | • | • |
| HWB18 | PDM31002ZXM | – | 200A | 30A | 18 | 5.5-6.5 Nm | IP67 & IP69K | 60x38x74mm | • | | Black | | • | • | |
| HWB12 | PDM33001ZXM | – | 130A | 30A | 12 | 5.5-6.5 Nm | IP67 & IP69K | 83x70x44mm | | • | Clear | • | • | • | |
| HWB12 | PDM33003ZXM | – | 130A | 30A | 12 | 5.5-6.5 Nm | IP67 & IP69K | 83x70x44mm | | • | Clear | • | • | • | • |
| HWB12 | PDM33004ZXM | – | 130A | 30A | 12 | 5.5-6.5 Nm | IP67 & IP69K | 83x70x44mm | | | Black | | | | • |
| HWB6 | PDM32001ZXM | – | 68A | 30A | 6 | 5.5-6.5 Nm | IP67 & IP69K | 71x64x36mm | | • | Clear | • | • | • | |
| HWB6 | PDM32003ZXM | – | 68A | 30A | 6 | 5.5-6.5 Nm | IP67 & IP69K | 71x64x36mm | | • | Clear | • | • | • | • |
| HWB6 | PDM32004ZXM | – | 68A | 30A | 6 | 5.5-6.5 Nm | IP67 & IP69K | 71x64x36mm | | | Black | | | | • |

Power Distribution Modules

HWA20 Series • ATO® Fuse Hard-Wired Box



Compact hard-wired fuse holder holds up to 10 ATO blade fuses, with a combined amperage up to 210A. Perfect for accessory circuits, overflow circuits from main power distribution module, or as a main module on smaller vehicles.

- Without internal bussing: enables the user to customize the circuitry.
- Dovetail slots on the sides of the box interlock with other units.
- Easy to connect wires plug into the back of the unit using industry-standard Tyco sealed power terminals.

Download additional technical information at: littelfuse.com/HWA20

3

| SERIES | PART NUMBERS | | MAX CONTINUOUS CURRENT | MAX FUSE RATING PER CIRCUIT | FUSE POSITIONS | MOUNTING TORQUE | INGRESS PROTECTION | DIMENSIONS | CONTENTS | | |
|--------|--------------|--------|------------------------|-----------------------------|----------------|-----------------|--------------------|-------------|----------|--------|------|
| | BULK | RETAIL | | | | | | | COVER | GASKET | TPAs |
| HWA20 | PDM61001ZXM | – | 210A | 40A | 10 | 4-6 Nm | IP67 | 161x40x52mm | • | • | • |



MTR Series • (2+2) MINI® & JCASE® Fuse Hard-Wired Box

Sealed low to medium current fuse holder houses two JCASE cartridge fuses and two MINI bladed fuses. Holder is gasket-sealed to protect fuses from moisture and contamination. Fuses are internally bussed to a single main power stud – one input powers four fuse circuits. Utilizes the MINI fuse for fast-acting 2-30A circuit protection and the JCASE cartridge style fuse with increased time delay for 20-60A medium current circuits. Output circuits are designed for use with Delphi terminals.

Download additional technical information at: littelfuse.com/MTR

| SERIES | PART NUMBERS | | MAX CONTINUOUS CURRENT | MAX INPUT CURRENT | FUSE POSITIONS | MOUNTING TORQUE | INGRESS PROTECTION | DIMENSIONS | CONTENTS | | |
|--------|--------------|--------|------------------------|-------------------|----------------|-----------------|--------------------|------------|----------|--------|------|
| | BULK | RETAIL | | | | | | | COVER | GASKET | TPAs |
| MTR | BPDMA104HXF1 | – | 100A | 2-60A | 4 | 6-8 Nm | IP67 | 86x34x77mm | • | • | • |



LTX Series • 4 position MEGA® & 2 position MIDI® Fuse Box

The LTX Power Distribution Module is a high current sealed primary fuse box that can be placed in the battery box, or near the battery box to fuse major feeder cables. Featuring bussed input to all 6 MEGA and 2 MIDI fuses. All bolt down connections are made inside of the seals which enhances the environmental protection of the box.

Download additional technical information at: littelfuse.com/LTX

| SERIES | PART NUMBERS | | VOLTAGE | MAX CONTINUOUS CURRENT | FUSE POSITIONS | MOUNTING TORQUE | INGRESS PROTECTION | DIMENSIONS | CONTENTS | | |
|--------|--------------|--------|----------|------------------------|----------------|-----------------|--------------------|--------------|----------|--------|--------|
| | BULK | RETAIL | | | | | | | COVER | GASKET | BUSBAR |
| LTX | 07981002ZXS | – | 6-32V DC | 240A | 6 | 10-12 Nm | IP66 | 231x312x60mm | • | • | • |



SL Series • 350A • Power Distribution Module

The SL Series provides main battery shutdown from a remote location, optional manual control knob switches high-amp circuits, three switched 30A to 200A MIDI® fuse location, four unswitched 24-hour 1A-20A ATO® fuse locations and eliminates significant factory or field interconnections

- Littelfuse Remote Control Switch: 880092

Download additional technical information at: littelfuse.com/SL

| SERIES | PART NUMBERS | | MAX CONTINUOUS CURRENT | MAX FUSE RATING PER CIRCUIT | | FUSE POSITIONS | TERMINAL STUD TORQUE | INGRESS PROTECTION | DIMENSIONS | CONTENTS | |
|--------|--------------|--------|------------------------|-----------------------------|-----|----------------|----------------------|--------------------|--------------|----------|--------|
| | BULK | RETAIL | | MIDI | ATO | | | | | COVER | GASKET |
| SL | 880076 | – | 350A | 170A | 30A | 7 | 20 Nm | IP59K | 152x102x45mm | • | |

Power Distribution Modules



MDB Series • MIDI® Fuse Distribution Box

Internally bussed, water-proof and dust-proof fuse holder developed for high current loads, and harsh conditions. The unit is well-suited for near-the-battery applications and can be mounted in exposed locations to fit your design. Available for 2 or 3 MIDI fuses and includes the cover seal and M5 thread bolts for a fuse installation. Kits include seals, plugs and caps. Fuses are sold separately.

- AssureLatch™ Technology keeps the cover securely in place while allowing for fast service.
- Included tether connects cover to base preventing misplacement.
- The module is internally bussed allowing for high current power distribution.
- Sealed to IP67 and IP69K for maximum flexibility in mounting location.

Download additional technical information at: littelfuse.com/MDB

| PART NUMBERS | | POLES | VOLTAGE | MAX CONTINUOUS CURRENT | MAX FUSE RATING PER CIRCUIT | MOUNTING TORQUE | INGRESS PROTECTION | DIMENSIONS | CONTENTS | |
|--------------|------------|-------|----------|------------------------|-----------------------------|-----------------|--------------------|-------------|---|---|
| BULK | BOXED | | | | | | | | | |
| 04980932ZXT | – | 2 | 6-58V DC | 200A | 200A | 6-8 Nm | IP67 & IP69K | 131x68x38mm | 2-pole box with busbar and nuts | |
| 04980933ZXT | – | 3 | 6-58V DC | 200A | 200A | 6-8 Nm | IP67 & IP69K | 131x68x38mm | 3-pole fuse box with busbar and nuts | |
| – | 04980932.X | 2 | 6-58V DC | 200A | 200A | 6-8 Nm | IP67 & IP69K | 131x68x38mm | Input: 1x 25 mm² cap 1x 25 mm² seal | Output: 2x 6-10 mm² seal 3x 10-16 mm² seal 1x plug & 1x 6-16 mm² cap |
| – | 04980933.X | 3 | 6-58V DC | 200A | 200A | 6-8 Nm | IP67 & IP69K | 131x68x38mm | | |



LX Series • 200A & 600A • ATO® & MIDI® Fuse PDM

Protect high and low-amp circuits while providing a collection point for ground returns, and eliminate battery box clutter and damage to battery terminals when adding circuits. Combines an ignition protected fuse block with screw termination. Holds four 30A-200A MIDI fuses and six 1A-30A ATO fuse locations. Negative bus provides common location for ground returns.

- The 880094 provides one fused input feeding the unit and other fuses while, the 880089 has an unfused input feeding the fuse circuits.

Download additional technical information at: littelfuse.com/LX

| SERIES | PART NUMBERS | | MAX CONT. CURRENT | MAX FUSE RATING PER CIRCUIT | | FUSE POSITIONS | TERMINAL STUD TORQUE | INGRESS PROTECTION | DIMENSIONS | CONTENTS | | |
|--------|--------------|--|-------------------|-----------------------------|-----|----------------|----------------------|--------------------|--------------|----------|--------|--------|
| | BULK | | | MIDI | ATO | | | | | COVER | GASKET | PULLER |
| LX | 880089 | | 600A | 170A | 30A | 10 | 20 Nm | IP59K | 165x127x51mm | • | • | • |
| | 880094 | | 200A | 170A | 30A | 10 | 20 Nm | IP59K | 165x127x51mm | • | • | • |



XT Series • 350A • ATO® & MIDI® Fuse PDM

The XT combines an ATO fuse block that has integrated sealed plug outputs (FCI APEX 2.8mm female 4-way connector p/n 54200409) and a MIDI fuse block that consolidates up to seven circuits from 1–200A. Three 30–200A MIDI fuse locations are ideal for high-amp circuits and four 1–40A ATO fuse locations for low-amp circuits. Tin-plated copper busbar and stainless steel studs and hardware provides superior corrosion resistance.

Download additional technical information at: littelfuse.com/XT

| SERIES | PART NUMBERS | | MAX CONTINUOUS CURRENT | MAX FUSE RATING PER CIRCUIT | | FUSE POSITIONS | TERMINAL STUD TORQUE | INGRESS PROTECTION | DIMENSIONS | CONTENTS | |
|--------|--------------|--|------------------------|-----------------------------|-----|----------------|----------------------|--------------------|--------------|----------|--------|
| | BULK | | | MIDI | ATO | | | | | COVER | GASKET |
| XT | 880073 | | 350A | 170A | 30A | 7 | 20 Nm | IP59K | 152x102x45mm | • | • |

Power Distribution Modules



FLEC® Series • Configurable Flexible Electrical Center

The Flexible Electrical Center (FLEC) is a power distribution module for the commercial vehicle market. It accommodates circuit protection components in a compact, sealed footprint. The PCB accepts active and passive devices. Part number below is a standard market version but FLEC is configurable to your custom electrical schematic and can be programmed to create a simple “plug-and-play” system.

- High component density maximizes available space and limits the number of additional units required.
- The versatile nature of the FLEC unit means it can accept a large number of component types.
- Rugged and sealed, the unit boasts an IP67 rating which allows it to be mounted in locations susceptible to moisture and dirt without any adverse effects

Download additional technical information at: littelfuse.com/FLEC

| SERIES | PART NUMBER | DESCRIPTION | VOLTAGE | MAX LOAD | MAX FUSE RATING | FUSE CAPACITY | RELAY CAPACITY | INGRESS PROTECTION | OUTPUT CONNECTORS |
|--------|--------------|--------------------------|-----------|----------|-----------------|---------------|----------------|--------------------|-------------------|
| FLEC | FLEC3000Z-0 | With MINI Fuses & Relays | 12-24V DC | 300A | 30A | 28 | 18 | IP67 | Delphi GT |
| FLEC | FLEC3000Z-0U | No Fuses or Relays | 12-24V DC | 300A | 30A | 28 | 18 | IP67 | Delphi GT |



MiniFlec Series • 150A • Connectorized Power Distribution Module

The standard MiniFlec is a compact, front access, internally bussed, connectorized, sealed power distribution module, suitable for mounting in rugged commercial vehicle applications. An internally mounted Printed Circuit Board (PCB) allows bussed connections to a large number of devices.

- Designed for panel mounting (rear fed connectors). Base compression limiters prevent over-torquing when unit is mounted
- Tethered cover securely latches to base, with positive AssureLatch yellow latches

Download additional technical information at: littelfuse.com/MINIFLEC

| SERIES | PART NUMBERS | MAX LOAD | FUSE RATING RANGE | INPUT STUD | MOUNTING TORQUE | INGRESS PROTECTION | DIMENSIONS | RELAY CAPACITY |
|----------|--------------|----------|---|------------|-----------------|--------------------|----------------------|--|
| | BULK | | | | | | | |
| MINIFLEC | LFMX0007Z-01 | 150A | MINI® Fuse: 2-30A MCASE+® Fuse: 15-60A | M8 | 12-15Nm | IEC 529 IP67/69K | 157mm x 96mm x 126mm | 3 Form C 280 Series Micro Relays, 3 Form A Ultra Micro Relays, 1 ISO Micro Relay |



EPC Series • 200A • Connectorized Power Distribution Module

The standard EPC is an internally bussed, connectorized, sealed power distribution module, suitable for mounting in rugged commercial vehicle applications. The EPC is a product that has dense concentration of high power circuits and accepts plug devices like automotive fuses, diodes and relays to protect and control complex electrical systems. An internally mounted Printed Circuit Board (PCB) allows bussed connections to a large number of devices.

Download additional technical information at: littelfuse.com/EPC

| SERIES | PART NUMBERS | MAX LOAD | FUSE RATING RANGE | MOUNTING TORQUE | INGRESS PROTECTION | DIMENSIONS | RELAY CAPACITY |
|--------|--------------|----------|-------------------|-----------------|--------------------|-----------------------|---|
| | BULK | | | | | | |
| EPC | LFMX0006Z-01 | 200A | 5 to 30A | 6 - 8 Nm | IP67 / IP69K | 179mm x 155mm x 69 mm | Tailor to application - Up to 3 Form C 280 and 6 Form A 280 Relays |



FHZ Series • 400A • Power Distribution Module

The 5 Stud ZCASE Fuse Holder uses a single power input (usually with a ZCASE shunt) and a common busbar to feed up to 4 additional ZCASE fused circuits. Freely interchangeable ZCASE fuse ratings; configurable stud size (M6, M8, or M10); and available 2-, 3-, 4-, or 5-position busbars allow for a wide range of possible configurations.

Download additional technical information at: littelfuse.com/5StudZCASE







| SERIES | PART NUMBER | DESCRIPTION | AMPERAGE | MAX FUSE RATING | FULL ASSEMBLY | CONTACT TEMP | DIMENSIONS |
|--------|-------------|---------------------------------|----------|-----------------|---------------|----------------|---------------------|
| FHZ | 0FHZ0001Z | Assembly with Bolts and Bus Bar | 400A | 40-600A | | -40° to 105° C | 217mm x 86mm x 59mm |
| FHZ | 0FHZ0002Z | Full Assembly with M10 Input | | | • | | |
| FHZ | 0FHZ0003Z | Box Only for Configuration | | | | | |
| FHZ | 0FHZ0005Z | Full Assembly with M8 Input | | | • | | |

Ingress Protection Explained

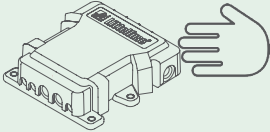
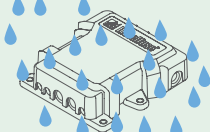
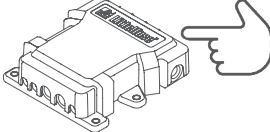
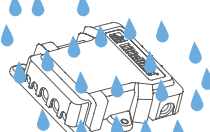
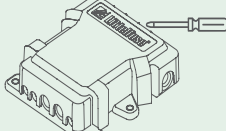
Harsh Environments and Ingress Protection Ratings

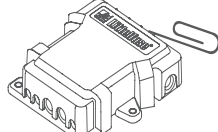
Environmental factors play a huge role in a product's ability to do its job and survive the lifetime of the equipment. Ingress Protection, or IP, indicates the degree of protection of a power distribution module. IP ratings are a measure of how resistant a part is to environmental contaminants such as debris, dust, and water. IP rating selections should be based on where the PDM will be mounted and what type of environment the equipment will be used in.

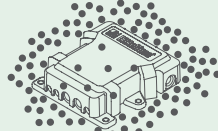
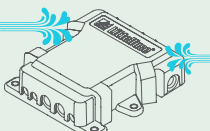
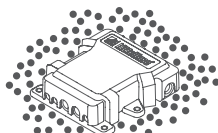
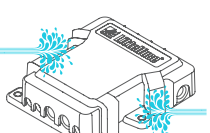
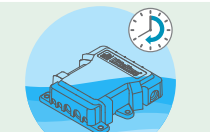
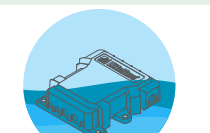
The numbers following IP represent levels of sealing and can range from no sealing (IP00) to protection against dust and continuous immersion in water (IP68). The table below provides a description of the protection at each level.

| 1st Digit - SOLID Degree of protection against solid objects | 2nd Digit - LIQUID Degree of protection against water |
|---|---|
|  <p>1 Protected against a solid object greater than 50mm</p> |  <p>1 Protected against vertically falling water drops</p> |
|  <p>2 Protected against a solid object greater than 12.5mm</p> |  <p>2 Protected against vertical water drops when enclosure tilted up to 15 degree angle</p> |
|  <p>3 Protected against a solid object greater than 2.5mm</p> |  <p>3 Protected against spraying water from up to a 60 degree angle</p> |
|  <p>4 Protected against a solid object greater than 1.0mm</p> |  <p>4 Protected against splashing water</p> |
|  <p>5 Dust Protected. Prevents ingress of dust sufficient to cause harm</p> |  <p>5 Protected against water jets</p> |
|  <p>6 Dust tight. No ingress of dust.</p> |  <p>6 Protected against powerful water jets</p> |
| <p>Example</p> <p>IP67</p> <p>Dust tight. No ingress of dust. Protected against effects of temporary submersion in water.</p> |  <p>7 Protected against the effects of temporary immersion in water between 15cm and 1m for 30 minutes</p> |
| |  <p>8 Protected against the effects of continuous immersion in water under conditions agreed between manufacturer and user</p> |
| |  <p>9K Protected against close-range high pressure, high temperature spray downs</p> |

Battery Management



Isolators or Combiners?

Battery Isolators are passive (not intelligent) devices. They are a basic technology that prevents current from draining from one battery into the other. As current passes through the internal diodes there's a loss of efficiency, that equates to a voltage loss of 10-15%. Another problem arises when battery isolators are used with the more recent 'smart alternators'. Such alternators incorporate sensors which 'read' the state of the battery, but the isolator's diodes interfere with the alternator's sensors. It is therefore important to use a battery combiner in such application.

Battery combiners provide the same function as isolators, but without the substantial voltage loss, and they work in harmony with smart alternators. They also may have additional useful features, such as boost; they are smaller and lighter; and since they are installed between the battery banks, there is no need to cut the original OEM heavy cable from alternator to battery.

No More Dead Batteries!

If you leave a fully charged battery connected in an inactive vehicle, it could be dead in as little as two months. Vehicles have electronics that continue to draw small quiescent currents to maintain their memory, even when the vehicle is off. Over an extended period of time this small current can drain the battery. Complete discharge of the battery can cause permanent damage and prevent proper battery recharging.

If your vehicle requires short or long term storage and has a lot of electronics (computer, TV, stereo, etc) a Low Voltage Disconnect can be installed to automatically disconnect these components when battery voltage falls below a critical threshold and automatically reconnects when the battery is recharged. This lengthens the storage life of your battery.

85-200A Smart Battery Isolators



Battery Combiners are hybrid electronic/electromechanical relays that prevent loads on the auxiliary battery from draining the starting battery. This type is more flexible than Diode Battery Isolators: works with all types of alternator; it is smaller and lighter; no efficiency loss due to diodes; allows bi-directional charging from the alternator or from shore power; reduces the load on the charging system by not connecting the auxiliary battery until the primary battery is charged to 13.2V.

- Works with most types of alternators
- Smaller and lighter than traditional isolators
- No efficiency losses due to diodes
- Allows bi-directional charging from the alternator or from shore power
- Reduces the load on the charging system by not connecting the auxiliary battery until the primary battery is charged to 13.2V extending the life of expensive charging components.

Datasheet, wiring diagram, and 2D prints: littelfuse.com/BatteryManagement

| PART NUMBERS | | AMPS | VOLTAGE | TERMINAL STUDS | INGRESS PROTECTION | CONNECT VOLTAGE | DISCONNECT VOLTAGE | QUIESCENT CURRENT | TERMINAL STUD TORQUE |
|--------------|----------|------|----------|----------------|--------------------|--------------------------|--------------------|----------------------|----------------------|
| BULK | BOXED | | | | | | | | |
| 48525 | 48525-BX | 85A | 9-16V DC | 5/16-24" | IP66 | 13.2V typical after 2min | 12.7V after 1min | 5mA typical, 8mA max | 35 in-lbs (3.95Nm) |
| 48530 | 48530-BX | 200A | 9-16V DC | 5/16-24" | IP66 | 13.2V typical after 2min | 12.7V after 1min | 5mA typical, 8mA max | 35 in-lbs (3.95Nm) |

4

3 & 4 Stud Diode Battery Isolators

For vehicles with two batteries, these devices electrically isolate the batteries to prevent the battery with the higher charge from draining into that with the lower charge. In addition, both batteries can be charged simultaneously from one source.

The solid-state components are embedded to give excellent protection from adverse conditions, such as contamination and vibration. The integral heat sink provides efficient heat dissipation. The amp rating of each item is the maximum alternator rating.

Some alternators on vehicles have an integral electronic voltage regulator that requires the use of the 4-stud battery isolator. The small 4th stud is for connection to a circuit switched by the ignition switch. These alternators were first introduced by Delco and are therefore sometimes called 'Delcotron-type alternators'. Battery Isolators have a 'per leg' rating which indicates the maximum current that it can deliver to each battery. All Battery Isolators have a per leg rating equal to half the alternator rating. Thus a 48122 battery isolator with an alternator rating of 140A has a per leg rating of 70A per leg.

Additional information: littelfuse.com/BatteryManagement

Schottky Diode - Comply to KKK-A-1822B spec for Ambulances



| PART NUMBERS | | AMPS | VOLTAGE | TERMINALS | | DIMENSIONS | ALTERNATOR TYPE |
|--------------|----------|------|-------------|-----------------|------------------|------------------------------|---|
| BULK | BOXED | | | NUMBER OF STUDS | THREADS | | |
| 48051 | 48051-BX | 75A | 12V DC Only | 2 | 2x 1/4" | 3-1/2" x 4-15/16" x 3-11/32" | - |
| 48161 | 48161-BX | 250A | 12-36V DC | 3 | 3x 5/16" | 8-1/2" x 4-3/16" x 3-13/32" | Delcotron-Type |
| 48122 | 48122-BX | 140A | 12-36V DC | 4 | 3x 5/16" & 1 #10 | 6" x 4-3/16" x 3-11/32" | |
| 48162 | 48162-BX | 200A | 12-36V DC | 4 | 3x 5/16" & 1 #10 | 8-1/2" x 4-3/16" x 3-13/32" | Without Integral Electronic Voltage Regulator |
| 48070 | 48070-BX | 70A | 12-36V DC | 3 | 3x 1/4" | 5" x 3-1/4" x 2-3/16" | |
| 48090 | 48090-BX | 90A | 12-36V DC | 3 | 3x 1/4" | 6-1/2" x 3-1/4" x 2-13/16" | |
| 48120 | 48120-BX | 140A | 12-36V DC | 3 | 3x 5/16" | 6" x 4-3/16" x 3-11/32" | |
| 48160 | 48160-BX | 200A | 12-36V DC | 3 | 3x 5/16" | 8-1/2" x 4-3/16" x 3-13/32" | |

3- Stud Wiring Diagram

48070, 48080, 48090, 48160 and 48161



Battery Combiners & FlexMod™ Devices

FlexMod™ Electronic Devices

The FlexMod Series of products are compact, robust electronic modules with two inputs (one analog and one digital) and two solid state outputs (one 10A, one 200 mA) that can be programmed to do almost any job. Littelfuse offers standard units listed below to meet the most common application needs.

Additional technical information: Littelfuse.com/FlexMod

- Auto-ranging to automatically senses the voltage of the system (12 or 24V) and selects the presets appropriate to that voltage.
- Ultra low 1mA standby current means minimal battery drain – especially valuable when vehicle is in storage or not in use.
- Factory programmable unit is versatile with a broad range of presets available for special applications.
- Rated for more than 1,000,000 on-off cycles – unit operates for the lifetime of the vehicle. Solid state technology gives long life and low maintenance.
- Provides overvoltage and overcurrent protection to every direct load in that circuit– for extra protection.
- Small lightweight sealed design – Uses less space; mounts outside or inside. Saves money by eliminating other hardware, and provides better wire routing



4

| PART NUMBERS | | TYPE | HARNESS INCLUDED |
|--------------|-------------|-----------------------------------|------------------|
| BULK | BOXED | | |
| – | 48636-01-BX | Timer for Trailer Lighting | • |
| 48610 | 48610-BX | Low Voltage Disconnect | |
| – | 48541-01-BX | Voltage Sensing Relay & Timer | • |
| 48540 | – | Smart Battery Isolator Controller | |
| – | 48540-01-BX | Smart Battery Isolator Controller | • |

Low Voltage Disconnect - 48610: Preserves battery charge and protects battery banks by automatically disconnecting loads when battery voltage drops to a critical level.

Smart Battery Isolator Controller - 48540: Monitors two battery banks and controls one relay or contactor to make sure starting power is protected by isolating the starting and auxiliary battery banks.

Low Voltage Disconnect Accessories

Accessories for 48513 and 48514 series low voltage disconnects.



58326-06



55088



12804

| PART NUMBERS | | DETAILS | NOTES |
|--------------|----------|-----------------|---|
| BULK | BOXED | | |
| 48710 | - | FlexMod Unit | Programmable FlexMod LVD Unit • 10A • 9V DC |
| 58326-06 | - | Rocker Switch | SPDT • On-Off-Mom On • 5 Blade Terminals • Red LED |
| 55088 | 55088-BX | Toggle Switch | SPDT • On-Off-Mom On • 3 Screw Terminals |
| 12804 | - | Harness | Deutsch DT06-4S connector • 0462-201-1641 terminal • W4S wedge and wiring |
| 12805 | - | FlexMod Harness | FlexMod 8-Pin Deutsch Harness Accessory |

How A Smart Battery Isolator Works

Normal Operation Sequence

1 When the vehicle has been running, the alternator charges both battery banks through the Smart Isolator.



2 When the engine is turned off, the alternator no longer supplies a charge to the batteries, and the loads on the batteries begin to deplete them.



3 When batteries reach 12.7V, the Smart Battery Isolator senses it, opens the solenoid relay to separate the battery banks, and turns off the status light. This protects the starting battery while allowing the auxiliary battery to continue to power the auxiliary loads.



4 When the vehicle is restarted, the starting battery has enough power to crank the engine, but the auxiliary battery is significantly depleted. The Smart Battery Isolator is open and the battery banks are separated.



5 The engine is powering the alternator, and the starting battery has reached 13.2V. Only now does the Smart Battery Isolator reconnect, enabling the depleted auxiliary battery to be charged. By not reconnecting until the main battery is charged, the alternator is protected from excessive loads.



6 Now both batteries are charged again.



Relays & Solenoids



DC solenoids are relays used for remote switching of electrical currents from 20A to 600A. Littelfuse offers a variety of DC solenoids and relays, such as solid state relays, plug-in relays, compact relays among others.

Solenoids or Relays?

The terms solenoid and relay are interchangeable and refer to a type of remote switch. In the automotive context, solenoid refers to the metal can device. A relay refers to all other such devices including the small micro relays referenced later in this section. The word solenoid actually refers to the helical windings that create the magnetic force which pulls the plunger in the core. Littelfuse manufactures a very broad range of remote switches.



Intermittent or Continuous?

Relays are rated for Intermittent Duty or Continuous Duty. Intermittent duty relays are rated with maximum On times and minimum Off times, which is a workable situation in many applications. Exceed those specs and you run the risk of burning out the coil windings. You cannot use an Intermittent Duty relay for continuous service, but you can use a Continuous Duty relay for intermittent service – although you would be purchasing a relay that is in excess of your needs.

Bistable & Latching?

When it comes to solenoids or relays, both bi-stable and latching refer to the same function. A bi-stable state is one in which a moving contact is at rest in two configurations, either the On or Off position. This is achieved by a mechanical or magnetic latching mechanism which maintains contact in the ON or OFF position while device is not energized. A more well-known example of the mechanical style is the mechanism of a retractable ballpoint pen, where the user pushes to move the ballpoint out of the housing, and pushes again to retract the ballpoint. The point remains in either of two stable states until the user presses the actuator.

In standard solenoids or relays, a control current has to be maintained in order to keep the plunger in the On position; in a bi-stable relay, control current is only applied when changing between the two states of Off and On. This provides many advantages – no current is used in the On or Off states, and bi-stable relays generate less heat.



Bi-Stable Latching Relays



HD Series • 300A General Purpose Bi-Stable Relays

- Very low current draw to maintain closed circuit
- Remotely-operated 300A disconnect for high-amperage circuits
- Small control wires: eliminates the cost and weight of routing large copper cables
- Bi-stable (latched) operation draws no current in On or Off: eliminates a continuous demand on batteries.
- LED output wire enables remote indication of relay status – Open or Closed.
- Silver alloy contacts assure the lowest voltage drop / resistance and extends cycling life of the device.
- Stainless steel hardware and tin-plated copper contacts maximize resistance in harsh environments.

Download additional technical information at: littelfuse.com/HD-Relay

| PART NUMBERS | | | VOLTAGE | AMPERAGE | INGRESS | NOTES |
|--------------|-------|--------|---------|----------|------------|-------|
| BULK | BOXED | RETAIL | | | | |
| 880086 | – | – | 12V DC | 300A | IP66/IP69k | – |
| 880088 | – | – | 24V DC | 300A | IP66/IP69k | – |



HD Time Delay Series • 250A Bi-Stable Relay

The Heavy Duty Time Delay Bi-Stable Relay is able to disconnect the battery from the electrical system of vehicles in 12V and 24V, with voltage self-recognition.

- It includes immediate switch ON, controlled switch OFF with programmable delay time and service state managing (service switch OFF and switch ON).
- This Heavy Duty Time Delay Bi-Stable Relay has a non-volatile memory, low battery alert system and is thermal protected.

Download additional technical information at: littelfuse.com/HDTimeDelay

| PART NUMBERS | VOLTAGE | AMPERAGE | VOLTAGE RANGE | INGRESS | NOTES |
|--------------|-----------|----------|--------------------|---------|---|
| 08070900 | 12/24V DC | 250A | 8.5V to 32V @ 23°C | IP67 | Light Line Current Rating: 1.3A continuous (6.5A protected) |

SD Series • 300-600A Bi-Stable Relay

An all-vehicle battery disconnect, designed to support remote power switching applications. Great for high continuous current passage, large engine starting needs and high ambient temperatures.

- Small control wires: eliminates the cost and weight of routing large copper cables to an accessible switch
- Dedicated 24-hour output, thermally protected, for tachograph or other keep-alive functions.
- Supports multiple Off switch control applications.
- Ignition protected to SAE J1171 and ISO 8846 for installation in battery box or with hazardous loads.
- Auxiliary relay contacts (normally open & normally closed) for Alternator Field Disconnect (AFD) or for additional vehicle system control

Download additional technical information at: littelfuse.com/SD-Relay



| PART NUMBERS | | | VOLTAGE | AMPERAGE | CIRCUITRY | INGRESS | NOTES |
|--------------|---------|--------|---------|----------|-----------|------------|-------------------------|
| BULK | BOXED | RETAIL | | | | | |
| 880107 | 880107S | – | 12V DC | 300A | Dual Pole | IP66/IP69k | 4/0 input/output cables |

48785 • 85A Electronic Relay/Switch

Fully solid-state with no moving parts to wear out that is completely sealed, ignition protected and designed to withstand vibration for harsh environments. Relays can be used in both high side and low side switching application and are suitable for high inrush demand circuits.

- Resistance: .005 Ω
- Control Current: .02A max
- Temperature Range: -40°C to +85°C
- On-Off Cycles: 20 million

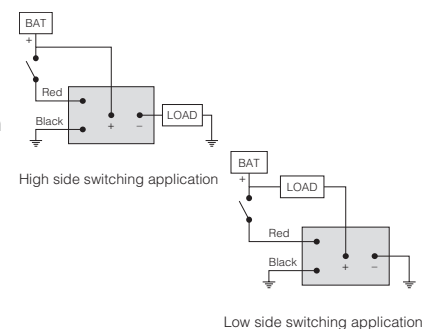

| PART NUMBERS | | | VOLTAGE | AMPERAGE | | INGRESS | DIMENSIONS |
|--------------|----------|--------|----------|------------|--------------|---------|--------------------|
| BULK | BOXED | RETAIL | | CONTINUOUS | INTERMITTENT | | |
| 48785 | 48785-BX | – | 9-31V DC | 85A | 175A | IP67 | 3.0 x 5.0 x 2.9 in |

Standard High Current Relays

6-36V DC • 35-200A • Continuous Duty Solenoids

- Hex nuts and lock washers are included
- Steel housing mounting holes: 5/16 x 19/32," 2 13/64" on centers (7.9 x 15.1, 56.0mm)
- Plated steel housing available with optional PVC coating available to protect critical components from environmental hazards

Datasheet, wiring diagram, and additional pack sizes: littelfuse.com/ContinuousDutySPST

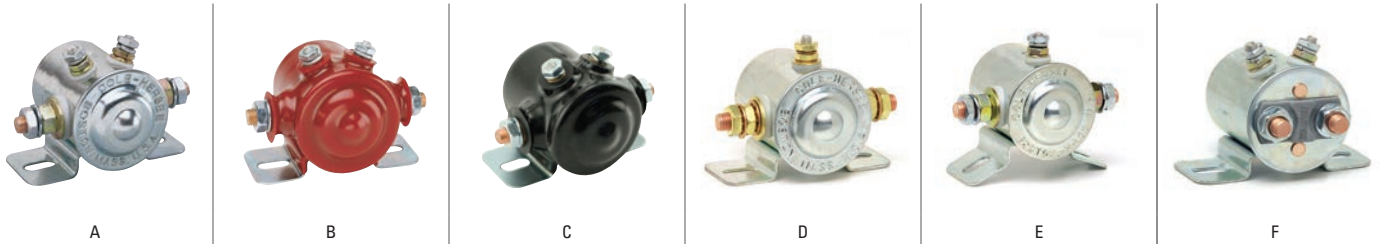

5

| PART NUMBERS | | | VOLTAGE | AMPS | INSULATED / GROUNDED | CIRCUITRY | FORM / CONTACTS | CONTACT | TERMINALS | | PVC COATED | UL LISTED | IMAGE | DIAGRAM | NOTES |
|--------------|-------------|-------------|---------|------|----------------------|-----------|-----------------|---------|-----------------|--------------|------------|-----------|-------|---------|--|
| BULK | BOXED | RETAIL | | | | | | | LARGE | SMALL | | | | | |
| 24080 | 24080-BX | - | 36 | 85 | Insulated | SPST | NO | Copper | | | | | A | 1 | |
| 24063 | 24063-BX | - | | 85 | Insulated | SPST | NO | Copper | | | | | A | 1 | |
| 24063-08 | 24063-08-BX | - | | 85 | Insulated | SPST | NO | Copper | | | • | • | B | 1 | |
| 24214 | 24214-BX | - | 24 | 200 | Insulated | SPST | NO | Silver | | | | | A | 1 | |
| - | 24107-BX | - | | 85 | Insulated | SPST | NO | Copper | | | | | D | 2 | |
| 24124 | 24124-BX | - | | 85 | Grounded | SPST | NO | Copper | | | | | D | 4 | |
| 24115 | 24115-BX | - | | 85 | Insulated | SPST | NO | Copper | | | | | D | 3 | |
| 24059 | 24059-BX | - | | 85 | Insulated | SPST | NO | Copper | | | | | A | 1 | |
| 24059-15 | - | - | | 85 | Insulated | SPST | NO | Silver | | | | | A | 1 | |
| 24059-08 | 24059-08-BX | 24059-08-BP | | 65 | Insulated | SPST | NO | Copper | Copper 5/16"-24 | Steel 10-32" | | • | A | 1 | Intermittent rating: 750A Make, 100A Break 10 sec on, 30 min off |
| 24117 | 24117-BX | - | | 85 | Insulated | SPST | NO | Copper | | | • | | B | 1 | |
| 24117-01 | 24117-01-BX | 24117-01-BP | 12 | 65 | Insulated | SPST | NO | Copper | | | • | • | B | 1 | Intermittent rating: 750A Make, 100A Break 10 sec on, 30 min off |
| 24213 | 24213-BX | - | | 200 | Insulated | SPST | NO | Silver | | | | | A | 1 | |
| 24213-01 | - | - | | 200 | Insulated | SPST | NO | Silver | | | | | A | 1 | Potted Coil - IP66 |
| 24213-03 | - | - | | 200 | Insulated | SPST | NO | Silver | | | • | | C | 1 | Black Coating |
| 24106 | 24106-BX | - | | 85 | Grounded | SPST | NO | Copper | | | | | D | 4 | |
| 24106-07 | 24106-BX | - | | 85 | Grounded | SPST | NO | Copper | | | | | C | 4 | P/N, Date Code, Voltage ink stamped on surface |
| 24082 | 24082-BX | - | | 85 | Grounded | SPST | NO | Copper | | | | | E | 4 | Curved Bracket |
| - | 24420-BX | - | | 35 | Insulated | SPST | NC | Copper | | | | | F | 5 | |
| 24097 | 24097-BX | - | 6 | 85 | Grounded | SPST | NO | Copper | | | | | A | 1 | |

Continuous Duty Solenoid Wiring Diagrams



Standard High Current Relays

12V DC • Intermittent Duty Solenoids

- Hex nuts and lock washers are included
- Steel housing mounting holes: 5/16 x 19/32," 2 13/64" on centers (7.9 x 15.1, 56.0mm)
- Phenolic housing mounting holes: 9/32 x 25/64," 2 7/64" on centers (7.1 x 9.9, 53.6mm)
- Solenoids available in phenolic, plated steel or PVC coated housings to protect critical components from environmental hazards
- Resistor shorting circuit solenoids (p/n 24103/24021) feature a 3 that is normally open and becomes common with 1 and 4 when the solenoid is energized. Commonly used in engine starting applications.

Datasheet, wiring diagram, and additional information: littelfuse.com/IntermittentDutySPST



| PART NUMBERS | | | VOLTAGE | AMPS | | DUTY CYCLE | INSULATED / GROUNDED | CIRCUITRY | FORM / CONTACTS | HOUSING MATERIAL | CONTACT TERMINALS | SMALL TERMINALS | IMAGE | DIAGRAM | NOTES | |
|--------------|----------|--------|---------|------|-------|---------------------------|----------------------|-----------|-----------------|------------------|-----------------------------|-----------------|--------------|---------|-------|--|
| BULK | BOXED | RETAIL | | MAKE | BREAK | | | | | | | | | | | |
| 24037 | 24037-BX | - | 12 | 750A | 100A | On: 10 sec Off: 20 min | Grounded | SPST | NO | Plated Steel | Copper 5/16" -24 threads | Copper 10-32 | A | 1 | | |
| 24071 | 24071-BX | - | 12 | 750A | 100A | On: 10 sec Off: 20 min | Grounded | | | | | | PVC Coated | B | 1 | |
| 24044 | 24044-BX | - | 12 | 750A | 100A | On: 10 sec Off: 20 min | Grounded | | | | | | Plated Steel | C | 1 | Curved Bracket |
| 24022 | 24022-BX | - | 12 | 750A | 100A | On: 10 sec Off: 20 min | Grounded | | | | | | Phenolic | D | 1 | |
| 24103 | 24103-BX | - | 12 | 750A | 100A | On: 10 sec Off: 20 min | Grounded | | | | | | Plated Steel | E | 3 | Resistor Shorting Circuit |
| 24021 | 24021-BX | - | 12 | 750A | 100A | On: 10 sec Off: 20 min | Grounded | | | | | | Phenolic | D | 3 | Resistor Shorting Circuit |
| 24047 | 24047-BX | - | 12 | 750A | 100A | On: 10 sec Off: 20 min | Insulated | | | | | | Plated Steel | E | 4 | |
| 24076 | 24076-BX | - | 12 | 750A | 100A | On: 10 sec Off: 20 min | Insulated | | | | | | PVC Coated | F | 4 | |
| 24060 | 24060-BX | - | 12 | 750A | 100A | On: 10 sec Off: 20 min | Insulated | | | | | | Plated Steel | A | 5 | |
| - | 24046-BX | - | 12 | 750A | 100A | On: 10 sec Off: 20 min | Insulated | | | | | | Plated Steel | A | 6 | |
| 24023 | 24023-BX | - | 12 | 750A | 100A | On: 10 sec Off: 20 min | Insulated | | | | | | Phenolic | D | 2 | |
| 24008-03 | - | - | 24 | 750A | 120A | On: 10 sec Off: 20 min | Insulated | | | | | | Plated Steel | E | - | Components shipped unassembled |
| 24008 | 24008-BX | - | 24 | 750A | 120A | On: 10 sec Off: 20 min | Insulated | | | | | | Plated Steel | E | - | Special spring for stronger contact return force |
| - | 24041-BX | - | 6 | 750A | 100A | On: 10 sec Off: 20 min | Insulated | | | | | | Plated Steel | A | - | |

5

Intermittent Duty Solenoid Wiring Diagrams



Standard High Current Relays

Continuous Duty Two Circuit Solenoids

Special applications: Forward and reverse systems in electric golf carts, garden tractors, fork lift trucks, winches, etc.

- Hex nuts and lock washers are included
- Mounting holes: 5/16 x 19/32," 2 13/64" on centers (7.9 x 15.1, 56.0mm)

Datasheet, wiring diagram, and additional information: littelfuse.com/ContinuousDutyDPST



| PART NUMBERS | | | VOLTAGE | AMPS | | COIL TYPE | CIRCUITRY | PVC COATED | CONTACTS | | TERMINALS | DIAGRAM |
|--------------|-------------|--------|---------|------|----|-----------|-----------|------------|----------|----------|--------------|---------|
| BULK | BOXED | RETAIL | | NC | NO | | | | MATERIAL | THREADS | | |
| 24402 | 24402-BX | - | 24 | 35 | 85 | Insulated | DPST | - | Copper | 5/16"-24 | Steel 10-32" | 1 |
| 24401 | 24401-BX | - | 12 | 35 | 85 | Insulated | DPST | - | Copper | 5/16"-24 | Steel 10-32" | 1 |
| 24401-04 | 24401-04-BX | - | 12 | 35 | 85 | Insulated | DPST | • | Copper | 5/16"-24 | Steel 10-32" | 1 |
| 24401-01 | 24401-01-BX | - | 12 | 35 | 85 | Grounded | DPST | - | Copper | 5/16"-24 | Steel 10-32" | 2 |

5

100-225A • Heavy Service Plastic Body Solenoids

For starting small engines, including lawn tractors, golf carts and sweepers.

- Small ignition and ground terminals are 10-32 thread
- Large contact terminals are 5/16" -24 thread.

Additional information: littelfuse.com/PlasticBodyRelays

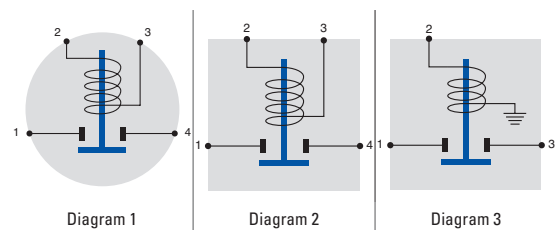

24848 - L-Bracket



24624-10 - F-Bracket



24612-10 - F-Bracket



24512-10 - Bracket

| PART NUMBERS | | | TYPE | VOLTAGE | MAX VOLTAGE | AMPS | | COIL TYPE | CIRCUITRY | FORM / CONTACTS | MOUNTING BRACKET | CONTACTS | COIL TERMINALS | DIAGRAM | |
|--------------|-------------|--------------|-----------------|-------------------|-------------|------------|--------|-----------|-----------|-----------------|------------------|-----------------|-----------------|-------------|---|
| BULK | BOXED | OTHER | | | | MAKE/BREAK | INRUSH | | | | | | | | |
| 24848 | - | - | Continuous Duty | 48 | 48 | 225 | 600 | Insulated | SPST | NO | L-Bracket | Silver 5/16"-24 | 10-32 studs | 1 | |
| 24824-01 | 24824-01-BX | - | | 24 | - | 225 | 600 | Insulated | SPST | NO | L-Bracket | Silver 5/16"-24 | 10-32 studs | 1 | |
| 24812 | 24812-BX | - | | 12 | 14 | 225 | 600 | Insulated | SPST | NO | L-Bracket | Copper 5/16"-24 | 10-32 studs | 1 | |
| 24812-01 | 24812-01-BX | - | | 12 | 14 | 225 | 600 | Insulated | SPST | NO | L-Bracket | Silver 5/16"-24 | 10-32 studs | 1 | |
| 24624-10 | 24624-10-BX | - | | 24 | 27 | 100 | 400 | Insulated | SPST | NO | F-Bracket | Silver 5/16"-24 | 10-32 studs | 2 | |
| 24512-10 | 24512-10-BX | - | | 12 | 14 | 100 | 400 | Insulated | SPST | NO | F-Bracket | Silver 5/16"-24 | Blade | 2 | |
| 24612 | 24612-BX | 24610-G10-BX | | 12 | - | 225 | 400 | Insulated | SPST | NO | L-Bracket | Silver 5/16"-24 | 10-32 stud | 1 | |
| 24612-10 | 24612-10-BX | - | | 12 | 14 | 100 | 400 | Grounded | SPST | NO | F-Bracket | Silver 5/16"-24 | 10-32 stud | 3 | |
| 24612-03 | 24612-03-BX | - | | Intermittent Duty | 12 | - | 200 | 300 | Insulated | SPST | NO | L-Bracket | Copper 5/16"-24 | 10-32 studs | 2 |

Reversing & Latching Solenoids



70A • Forward & Reverse Relay Module

Ideal for tarp or lift applications. Also use on hoists, hatches, winches, snowplows, intake/exhaust fans, vehicle outriggers and other reversing applications. Module automatically reverses the direction of the motor when the appropriate control circuit is energized with a pulse from a control switch. Dynamic braking stops the motor when the switch returns to Off.

- Dimensions: 2.91" × 3.51" × 1.86" H (73.9 × 91.7 × 47.2mm)

Download additional technical information at: littelfuse.com/24450

| PART NUMBERS | | | VOLTAGE | AMPERAGE | | INRUSH | SEALING | CONTACTS |
|--------------|----------|--------|---------|------------------------------------|------------|--------|---------|----------|
| BULK | BOXED | RETAIL | | INTERMITTENT | CONTINUOUS | | | |
| 24452 | 24452-BX | – | 12V DC | 70A (On: 5 min max, Off: 3 min) | 50A | 150A | IP67 | Silver |

5



12-24V DC • 150A Motor Reversing Intermittent Duty Solenoid

A combination of two solenoids in one package to reduce cost and maximize space savings while also providing simpler wiring.

- 75A Make/Break: 5 min On, 5 min Off
- 125A Make/Break: 30 sec On, 5 min Off
- 150A Make/Break: 0.5 sec On, 5 min Off

Download additional technical information at: littelfuse.com/24450



| PART NUMBERS | | | VOLTAGE | AMPS | COIL TYPE | CIRCUITRY | CONTACTS | TERMINALS | |
|--------------|----------|--------|----------------------|---------|---------------|-----------|----------|----------------|----------------------|
| BULK | BOXED | RETAIL | | | | | | Two Blade Coil | 5/16"-24 Large Studs |
| 24450 | 24450-BX | – | 12V DC (14.5 max) | 75-150A | Common Ground | DPDT | Copper | Two Blade Coil | 5/16"-24 Large Studs |
| 24450-02 | – | – | 24V DC | 75-150A | Common Ground | DPDT | Copper | Two Blade Coil | 5/16"-24 Large Studs |



24200 • 110A Standard High Current Latching Solenoid

Requires only a momentary application of coil power to operate. Minimal heat is generated, because the coil is de-energized when the solenoid is On.

- Continuous Duty Style (Rated at 110A carry only)

Download additional technical information at: littelfuse.com/24200



| PART NUMBERS | | | VOLTAGE | AMPS | COIL TYPE | CIRCUITRY | FORM / CONTACTS | HOUSING MATERIAL | CONTACTS | TERMINALS |
|--------------|----------|--------|---------|------|-----------|-----------|-----------------|------------------|-----------------|--------------|
| BULK | BOXED | RETAIL | | | | | | | | |
| 24200 | 24200-BX | – | 12V DC | 110A | Insulated | SPST | NO | Plated Steel | Copper 5/16"-24 | Steel 10-32" |

Plug-In Relays



Heavy Duty High Power and Micro Plug-In Relays

General purpose relays fit many vehicles and applications. Typical applications include: lighting, starting, horn, heating and cooling.

Standard ISO terminal footprint for Form A, Form C and Form 2A. Relays are available sealed and unsealed (unsealed 40 & 70A relays are supplied with snap-in brackets.)

Datasheet, wiring diagram, and additional information: littelfuse.com/Plug-In-Relays

Specifications

- Pull-in voltage: 78V maximum at 12V DC, 15.6 V at 24V DC
- Release voltage: 1.2 V minimum at 12V DC, 2.4 V at 24V DC
- Temperature range: -40°C to 85°C
- Operational life: Electrical to 100,000 cycles.
Mechanical to 10,000,000 cycles
- Contact Material: Silver alloy
- Dielectric strength: 500 V rms between coil and contact
- Insulation resistance: 100 MΩ minimum (500V DC)
- Relays are rated based on a steady state resistive load. De-rate according to the type of load.
 - Motor load: Inrush can be 5 to 10 x steady state current.
 - Solenoid load: Inrush can be 10 to 20 x steady state current.
 - Incandescent lamp load: Inrush can be 10 to 15 x steady state current.
- Available with PCB terminals, contact Littelfuse for details.

Heavy Duty Relays • 40A at 12V DC

- Contact rating (Resistive load) at 20°C:
 - 12V DC: Normally Open 40A, Normally Closed 30A
 - 24V DC: Normally Open 20A, Normally Closed 15A
- Contact arrangement: Available as Form A (SPST), Form C (SPDT) and Form 2A (SPST, 2 terminals)
- Vibration resistance: 10-40Hz double amplitude 1.5mm

High Power Relays • 70A at 12V DC

- Contact rating (Resistive load) at 20°C:
 - 12V DC: Normally Open 70A, Normally Closed 60A
 - 24V DC: Normally Open 35A, Normally Closed 30A
- Contact arrangement: Available as Form A (SPST) and Form C (SPDT)
- Vibration resistance: 10-40Hz double amplitude 1.5m

Micro Relays • 25A at 12V DC

- Contact rating (Resistive load) at 20°C:
 - 12V DC: Normally Open 25A, Normally Closed 20A
- Contact arrangement: Available as Form A (SPST), and Form C (SPDT).
- Vibration resistance: 10-40Hz double amplitude 1.27mm

Part Numbering System



Relay Part Numbers

| PART NUMBERS | | VOLTAGE | AMPS | RELAY TYPE | FORM | BRACKET | SUPPRESSOR TYPE | SEALED |
|--------------|-----------------|---------|------|------------|------|---------|-----------------|----------|
| BULK | BOXED | | | | | | | |
| R2-400112-RN | - | 12 | 40 | Relay | 2 | SPST | • | Resistor |
| RA-200024-DS | - | 24 | 20 | Relay | A | SPST | | Diode |
| RA-400012-DS | - | 12 | 40 | Relay | A | SPST | | Diode |
| RA-400112-DN | RA-400112-DN-BX | 12 | 40 | Relay | A | SPST | • | Diode |
| RA-400112-NN | RA-400112-NN-BX | 12 | 40 | Relay | A | SPST | • | None |
| RA-400112-RN | RA-400112-RN-BX | 12 | 40 | Relay | A | SPST | • | Resistor |
| RA-700112-RN | RA-700112-RN-BX | 12 | 70 | Relay | A | SPST | • | Resistor |
| RA-700112-DN | RA-700112-DN-BX | 12 | 70 | Relay | A | SPST | • | Diode |
| RA-700112-NN | RA-700112-NN-BX | 12 | 70 | Relay | A | SPST | • | None |
| RC-200024-DS | - | 24 | 20 | Relay | C | SPDT | | Diode |
| RC-200124-DN | RC-200124-DN-BX | 24 | 20 | Relay | C | SPDT | • | Diode |
| RC-200124-NN | RC-200124-NN-BX | 24 | 20 | Relay | C | SPDT | • | None |
| RC-200124-RN | RC-200124-RN-BX | 24 | 20 | Relay | C | SPDT | • | Resistor |
| RC-400012-DS | RC-400012-DS-BX | 12 | 40 | Relay | C | SPDT | | Diode |
| RC-400112-DN | RC-400112-DN-BX | 12 | 40 | Relay | C | SPDT | • | Diode |
| RC-400112-NN | RC-400112-NN-BX | 12 | 40 | Relay | C | SPDT | • | None |
| RC-400112-RN | RC-400112-RN-BX | 12 | 40 | Relay | C | SPDT | • | Resistor |
| RC-700112-DN | RC-700112-DN-BX | 12 | 70 | Relay | C | SPDT | • | Diode |
| RC-700112-NN | RC-700112-NN-BX | 12 | 70 | Relay | C | SPDT | • | None |
| RC-700112-RN | RC-700112-RN-BX | 12 | 70 | Relay | C | SPDT | • | Resistor |
| MC-250012-DN | - | 12 | 25 | Micro | C | SPDT | | Diode |
| MC-250012-NN | - | 12 | 25 | Micro | C | SPDT | | None |
| MC-250012-RN | - | 12 | 25 | Micro | C | SPDT | | Resistor |

Modular Relay Sockets • Bi-Stable Relay

Accepts Littelfuse brand relays and standard ISO relays.



- Modular – sockets dovetail together
- Accepts standard quick-connect terminals
- Easy mount bracket
- Constructed of rugged glass-filled polyamide
- Temperature range: -40°C to 85°C

| PART NUMBERS | | | RELAY TYPE | | FORM | NOTES |
|--------------|----------|------------------|------------|----------------|--------|---|
| BULK | BOXED | RETAIL CLAMSHELL | AMPERAGE | TERMINAL WIDTH | | |
| 99025 | 99025-BX | – | 70A | .375" | A | Use with Tyco (AMP) terminals 280756 or 280755 (consult terminal manufacturers for full specs) |
| 99026 | 99026-BX | – | 40A | .250" | A or C | Use with Tyco (AMP) terminals 42281 or Ark-Les 3000H112A series (consult terminal manufacturers for full specs) |

5

Plug-In Relay & MicroRelay Schematics and Terminal Layout

General purpose relays fit many vehicles and applications.

| FORM | RELAY SCHEMATICS | RELAY TERMINAL LAYOUTS (40A .250" terminals – 70A .375" terminals) | MICRORELAY TERMINAL LAYOUTS |
|--------|------------------|---|-----------------------------|
| Form A | | | |
| Form C | | | |
| Form 2 | | | – Not Available – |

Battery & Master Disconnect Switches



Master Disconnect Switches are available for any application and suitable for 12V to 48V and up to 500A continuous (at 12V). Other features include: single or dual pole configurations, stem or flange mount, with lockout/tagout and lever or keyed actuators.

Lockouts & Tagouts

Lockouts and tagouts prevent operators, technicians and maintenance personnel from unanticipated power-ups that might cause injury or death.

According to OSHA, "A lockout device utilizes a positive means such as a lock to hold an energy isolating device in a safe position and prevent the energization of a machine." A tagout is a tag or seal that states 'Do not operate or remove this tag' and is signed by the person who places the tagout. Procedures specify that nobody but that person may remove the tag.

A lockout on a battery switch not only keeps a vehicle safe, but also immobilizes it. A locked out vehicle is less vulnerable to battery drain or theft.



What is a Hencol Key?

Hencol is a Cole Hersee brand name used to describe our non-bitted common keys. Hencol keys are often used for ignition switches installed in forklifts or equipment that will have multiple operators. The non-bitted key allows any authorized user with a Hencol key to start and operator the vehicle.

The term Hencol is named after one of the Cole Hersee founders and is a truncation of his name, Henry Cole.





TR Series • 500A Dual Pole Battery Disconnect Switch

Cuts all battery power from vehicle electrical system, or for applications needing switching of two circuits, or both positive and negative.

- 500A continuous current rating for each of the two circuits (2x 4/0 input and 2x 4/0 output cables)
- Can be used to switch two vehicle voltage circuit simultaneously (12 & 24V DC)
- Built-in lockout satisfies OSHA requirements for an energy isolation device
- Ignition protected to SAE J1171 and ISO8846 for installation in a battery box or on vehicles carrying hazardous loads
- Ingress protection to IP67 and IP69k means that the switch can be mounted in exposed locations.

For datasheet, wiring diagram, and additional pack sizes visit: littelfuse.com/TRswitch

| PART NUMBERS | | | VOLTAGE | AMPERAGE | CIRCUITRY | INGRESS | MOUNTING METHOD |
|--------------|---------|--------|-----------|----------|-----------|--------------|-----------------|
| BULK | BOXED | RETAIL | | | | | |
| 880175 | 880175S | – | 12-24V DC | 500A | DPST | IP67 & IP69K | Surface Mount |



75920 Series • 400A Sealed Battery Disconnect Switch

Protects vehicles against tampering, theft and battery drain. Switch protects from hazards during vehicle servicing and provides an effective emergency power cutoff. Can be used in both positive or in negative path applications. Built-in lockout satisfies OSHA requirements for an energy isolation device.

- 400A continuous at 12V DC — 3000A intermittent at 12V DC (15sec on 5 min off)
- Waterproof and dustproof to IP68 - switch can be mounted in exposed locations
- Built-in lockout satisfies OSHA requirements for an energy isolation device
- Large red knob is easy to operate with gloves
- Large divider on base prevents accidental shorting of high energy cables

For datasheet, wiring diagram, and additional pack sizes visit: littelfuse.com/75920

| PART NUMBERS | | | VOLTAGE | AMPERAGE | CIRCUITRY | INGRESS | MOUNTING TYPE | NOTES |
|--------------|-------------|----------|-----------|----------|-----------|---------|---------------|---------------------------------|
| BULK | BOXED | RETAIL | | | | | | |
| 75920 | 75920-BX | 75920-BP | 12-36V DC | 200-400A | SPST | IP68 | Through-Hole | Bezel marked "off - on" |
| 75920-05 | 75920-05-BX | – | 12-36V DC | 200-400A | SPST | IP68 | Through-Hole | Bezel marked "O - I" symbols |
| 75920-10 | 75920-10-BX | – | 12-36V DC | 200-400A | SPST | IP68 | Through-Hole | Stainless Steel Hardware |
| 75921-10 | – | – | 12-36V DC | 200-400A | SPST | IP68 | Through-Hole | Stainless Steel Metric Hardware |



SR Series • 300A Flange Mount Battery Disconnect Switches

Isolates high current DC circuits from battery sources. Available in multiple case designs with optional padlock capability.

- 300A continuous current rating
- Tin-plated copper studs provide maximum conductivity and lower contact resistance.
- Stainless steel hardware provides superior corrosion resistance.
- Ignition protected to SAE J1171 and ISO8846 for installation in a battery box or on vehicles carrying hazardous loads.

For datasheet, wiring diagram, and additional pack sizes visit: littelfuse.com/SRswitch

| PART NUMBERS | | | MAX VOLTAGE | AMPERAGE (AT 12V DC) | CRANKING RATING (12V DC, 30sec) | INGRESS | MOUNTING METHOD | NOTES |
|--------------|---------|--------|-------------|----------------------|---------------------------------|--------------|-----------------|-----------------------------|
| BULK | BOXED | RETAIL | | | | | | |
| 880062 | – | – | 48V DC | 300A | 1250A (1 x 4/0 cable) | IP67 & IP69K | Through-Hole | – |
| 880064 | 880064S | – | 48V DC | 300A | 1250A (1 x 4/0 cable) | IP67 & IP69K | Surface Mount | Lock-Out |
| 880154 | – | – | 36V DC | 600A | 2500A (1 x 4/0 cable) | IP67 & IP69K | Surface Mount | High-Cranking with Lock-Out |
| 888842000A | – | – | 12 V DC | 5A | – | – | Panel Mount | – |

Battery Disconnect Switches



08098700

100-150A • SPST • UP4X/IP43 • Compact Battery Disconnect Switch

08098700 is Standard Compact Manual Battery Disconnect Switch that features a removable handle with a plastic body. Rated to 100A continuous current this switch is ideal light-duty applications.

08099080 is an upgraded design with bigger contacts (M10) and improved components for heavier 150A current loads within the same compact dimensions, which make it one of the most popular products for 12V applications. This Manual Battery Disconnect Switch features a removable handle with a plastic body and rubber cap is included for protection while switch is removed from the socket.

For additional information visit: littelfuse.com/ManualBatterySwitches



08099080

Mounting Diagram



Electrical Diagram



| PART NUMBERS | | | VOLTAGE | AMPERAGE | INTERMITTENT CURRENT | CIRCUITRY | INGRESS | MOUNTING | TERMINALS | TERMINAL HARDWARE | NOTES |
|--------------|-------------|-------------|-----------|----------|----------------------|-----------|---------|--------------|------------|-------------------|------------------|
| BULK | BOXED | RETAIL | | | | | | | | | |
| 08098700 | 08098700-BX | – | 12-24V DC | 100A | 500A at 5s | SPST | IP4X | Flange Mount | M8 Copper | Brass | – |
| 08098780 | 08098780-BX | – | 12-24V DC | 150A | 1000A at 5s | SPST | IP4X | Flange Mount | M10 Copper | Brass | – |
| 08099080 | 08099080-BX | 08099080-BP | 12-24V DC | 150A | 1000A at 5s | SPST | IP43 | Flange Mount | M10 Copper | Zinc-Plated Steel | Key Seal and Cap |

6



08080200

150A • SPST • IP65 • M10 Studs • Push to Off Compact Battery Disconnect Switch

Manual Battery Disconnect Switch features a push button for fast push to off operation in the event where a quick reaction is necessary.

Rotate knob for ON. Switch status is indicated through a window on the top of the knob.

For additional information visit: littelfuse.com/ManualBatterySwitches

| PART NUMBERS | | VOLTAGE | AMPERAGE | INTERMITTENT CURRENT | CIRCUITRY | INGRESS | MOUNTING | TERMINALS | NOTES |
|--------------|-------------|-----------|----------|----------------------|-----------|---------|--------------|--------------------------|-------------|
| BULK | BOXED | | | | | | | | |
| 08080200 | 08080200-BX | 12-24V DC | 150A | 1200A at 5s | SPST | IP65 | Through-Hole | M10 Silver-Plated Copper | Push to off |



08081400

200A • SPST • IP67 • Marine Single Pole Main Battery Switch

Marine single pole main battery switch with a metal body. Heavy duty and resistant against corrosion, to be used on heavy trucks, farm tractors, buses, commercial vehicles and especially on boats.

Switch features 200A continuous current rating, removable handle, the “V” shape of the terminals allows for easy cable connections, and reduces risk of arcing. This switch is also RINA ISO-8846 approved and is equipped with a white rubber protection cap.

For additional information visit: littelfuse.com/ManualBatterySwitches

| PART NUMBERS | | VOLTAGE | AMPERAGE | INTERMITTENT CURRENT | CIRCUITRY | INGRESS | MOUNTING | TERMINALS | NOTES |
|--------------|-------------|---------|----------|----------------------|-----------|---------|--------------|-----------|---------------|
| BULK | BOXED | | | | | | | | |
| 08081400 | 08081400-BX | 24V DC | 200A | 1000A at 5s | SPST | IP67 | Through-Hole | M10 Brass | Removable Key |

Battery Disconnect Switches



08098800

250A • SPST • IP65-IP69K • M10 Studs • Battery Disconnect Switch

Manual battery switch with removable or fixed handle and available with weather protective boots. For additional information visit: littelfuse.com/ManualBatterySwitches

08098800 - Base unit with removable handle

08098881 - Unit with removable handle and chain. Red and yellow rubber boots for weather protection and to help identify different applications. Interchangeable with Bosch 0341002003 switches

08098882 - Unit with fixed handle and integrated lock-out tag-out. Red, yellow and black rubber boots for weather protection and to help identify different applications. Latest design that does not require accessory for lockout tagout. Interchangeable with Bosch 0341002003 switches



08098882

Mounting Diagram

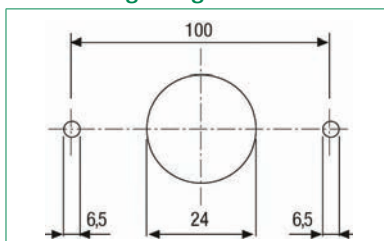

Electrical Diagram

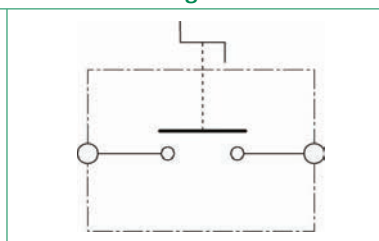

| PART NUMBERS | | VOLTAGE | AMPERAGE | INTERMITTENT CURRENT | CIRCUITRY | INGRESS | MOUNTING | TERMINALS | TERMINAL HARDWARE | NOTES |
|--------------|-------------|---------|----------|----------------------|-----------|------------|--------------|------------|-------------------|---|
| BULK | BOXED | | | | | | | | | |
| 08098800 | 08098800-BX | 24V DC | 250A | 2500A at 3s | SPST | IP65 | Flange Mount | M10 Copper | Zinc-Plated Steel | Removable Handle |
| 08098881 | 08098881-BX | 24V DC | 250A | 2500A at 3s | SPST | IP65/IP69k | Flange Mount | M10 Copper | Zinc-Plated Steel | Removable Handle w/ Chain, Keyhole Cover Red & Yellow Boots |
| 08098882 | 08098882-BX | 24V DC | 250A | 2500A at 3s | SPST | IP65/IP69k | Flange Mount | M10 Copper | Zinc-Plated Steel | Fixed Handle w/ Integrated Lock-Out Tag-Out Black, Red & Yellow Boots |



08010200

250A • SPST • IP65 • Push to Off Battery Disconnect Switch

Manual Battery Disconnect Switch features a turn to on and a push to off operation. Easy to operate and shut off vehicle power in emergency situations.

Switch features an identical mounting pattern to metal body removable key switches so the same application has multiple options with minimal design changes.

For additional information visit: littelfuse.com/ManualBatterySwitches

| PART NUMBERS | | VOLTAGE | AMPERAGE | INTERMITTENT CURRENT | CIRCUITRY | INGRESS | MOUNTING | TERMINALS | NOTES |
|--------------|-------------|---------|----------|----------------------|-----------|---------|--------------|--------------------------|-------------|
| BULK | BOXED | | | | | | | | |
| 08010200 | 08010200-BX | 24V DC | 250A | 2500A at 3s | SPST | IP65 | Flange Mount | M10 Silver Plated Copper | Push-to-Off |



08010100

300A • SPST • IP65 • 360° Rotation Battery Disconnect Switch

Manual Battery Disconnect Switch features a fixed handle and metal body. The handle and contacts are designed with a unique 360° operation for activating the switch ON-OFF. The handle can be rotated either left or right to switch the circuit status. Switch is ON when handle is aligned with the terminals and OFF when perpendicular with the terminals.

For additional information visit: littelfuse.com/ManualBatterySwitches

| PART NUMBERS | | VOLTAGE | AMPERAGE | INTERMITTENT CURRENT | CIRCUITRY | INGRESS | MOUNTING | TERMINALS | NOTES |
|--------------|-------------|---------|----------|----------------------|-----------|---------|--------------|------------|----------------------|
| BULK | BOXED | | | | | | | | |
| 08010100 | 08010100-BX | 24V DC | 300A | 1000A at 10s | SPST | IP65 | Flange Mount | M10 Copper | 360° Handle Rotation |

Battery Disconnect Switches



08098900

350A • SPST • IP65-IP69K • M12 Studs • Battery Disconnect Switch

Manual switches with a removable or fixed handle and weather protective boot depending on part number selected. For additional information visit: littelfuse.com/ManualBatterySwitches

08098900 - base unit with removable handle

08098980 - switch with removable handle with black boot and chain

08098981 - switch with fixed handle and black boot



08098980

Mounting Diagram



Electrical Diagram



| PART NUMBERS | | VOLTAGE | AMPERAGE | INTERMITTENT CURRENT | CIRCUITRY | INGRESS | MOUNTING | TERMINALS | TERMINAL HARDWARE | NOTES |
|--------------|-------------|-----------|----------|----------------------|-----------|------------|--------------|--------------------------|-------------------|---|
| BULK | BOXED | | | | | | | | | |
| 08098900 | 08098900-BX | 12-24V DC | 350A | 2500A at 3s | SPST | IP65 | Flange Mount | M12 Silver-Plated Copper | Zinc-Plated Steel | Removable Handle |
| 08098980 | 08098980-BX | 12-24V DC | 350A | 2500A at 3s | SPST | IP65 | Flange Mount | M12 Silver-Plated Copper | Zinc-Plated Steel | Removable Handle w/ Chain Keyhole Cover |
| 08098981 | 08098981-BX | 12-24V DC | 350A | 2500A at 3s | SPST | IP65/IP69K | Flange Mount | M12 Silver-Plated Copper | Zinc-Plated Steel | Fixed Handle w/ Black Boot |

6



250-500A • DPST • IP67/IP69K • Dual Pole Battery Disconnect Switch

250A-500A Dual Pole manual battery master switch with removable or fixed handle. High performance design with industry leading mechanics and materials featuring modern advancements in the design evolution of manual battery disconnects.

- Smartkey allows handle to removable or fixed, locking it in either the OFF or ON position
- Protective rubber cap with an auto-protection feature ensures protection when the handle is removed

For additional information visit: littelfuse.com/ManualBatterySwitches

Electrical Diagram



08084300 & 08084400

| PART NUMBERS | | VOLTAGE | AMPERAGE | INTERMITTENT CURRENT | CIRCUITRY | INGRESS | MOUNTING | TERMINALS | TERMINAL HARDWARE | NOTES |
|--------------|-------------|---------|----------|----------------------|-----------|------------|--------------|--------------------------|---------------------|-------|
| BULK | BOXED | | | | | | | | | |
| 08084300 | 08084300-BX | 24V DC | 250A | 1000A at 2s | DPST | IP67/IP69K | Flange Mount | M10 Silver-Plated Copper | Nickel Plated Brass | - |
| 08084400 | 08084400-BX | 24V DC | 500A | 1500A at 2s | DPST | IP67/IP69K | Flange Mount | M12 Silver-Plated Copper | Nickel Plated Brass | - |

Single-Pole Battery Switches



2484 Series • 175A • SPST • Single Pole Metal Body Battery Disconnect Switches

Designed to disconnect the battery circuit on 6-36V DC systems.

- Two positions: Off-On.
- Mounting Stem: Brass, 3/4" -16 thread with one of two lengths:
 - 23/32" (18.3mm) long, fits panels up to 3/16" (4.8mm) thick
 - 17/32" (13.5mm) long, fits panels up to 1/4" (6.4mm) thick
- Torque: Mounting Stem 20 ft/lb max - 3/8" nuts 70-90 in/lbs
- Electrical ratings on UL labels are conservative

For datasheet, wiring diagram, and additional pack sizes visit: littelfuse.com/2484



2484 with steel case and diecast lever



2484-03 with steel case and Hencol lock



Dimensions



2-position lever model

| PART NUMBERS | | | VOLTAGE | AMPERAGE | | CASE | TERMINAL STUDS | MOUNTING STEM | | ACTUATOR | CONTACTS | INDEXING PIN | O-RING SEAL | TERMINAL SEAL | UL LISTED | | | | | | |
|--------------|------------|--------|----------|------------|-------------------------|--------------|----------------|---------------|------------|------------|--------------------------|--------------|-------------|---------------|-----------|---|---|--|--|--|--|
| BULK | BOXED | RETAIL | | CONTINUOUS | INTERMITTENT | | | MATERIAL | SIZE | | | | | | | | | | | | |
| 2484 | 2484-BX | - | 6V DC | 40A | 250A | Plated Steel | Two 3/8"-24 | Brass | 23/32 long | Lever | Copper | | | | • | | | | | | |
| | | | 12V DC | 20A | 125A | | | | | | Silver | | | | | • | | | | | |
| 2484-16 | 2484-16-BX | - | 6-36V DC | 175A | 800A (15s On-5m Off) | | | | | Hencol Key | Brass | | • | | | | | | | | |
| 24024 | - | - | | | | | | | | | Silver | | | | | | | | | | |
| 2484-A | 2484-A-BX | - | | | | | | | | Lever | Copper | | | | | | | | | | |
| 2484-06 | 2484-06-BX | - | | | | | | | | | Silver | | • | • | | | | | | | |
| 2484-09 | 2484-09-BX | - | | | | | | | | 17/32 long | 1000A (15s On-5m Off) | Hencol Key | Copper | | | | | | | | |
| 2484-02 | 2484-02-BX | - | | | | | | | | | | | Silver | | • | | | | | | |
| 2484-03 | 2484-03-BX | - | | | | | | | | | | | Silver | | • | • | | | | | |
| 2484-19 | 2484-19-BX | - | | | | | | | | | | | Silver | | • | • | • | | | | |

6

SPST Wiring Diagram



75908

75908 Series • 300A • SPST • Single Pole High Current Battery Switches

Designed to disconnect the battery circuit on 6-36V DC systems. Two positions: Off-On.

- Mounting Stem: Brass, 3/4" -16 thread, 17/32" (13.5mm) long fits panels up to 1/4" (6.4mm) thick
- Torque: Mounting Stem 20 ft/lb max - 3/8" nuts 70-90 in/lbs

For additional information visit: littelfuse.com/75908

| PART NUMBERS | | | VOLTAGE | AMPERAGE | | CASE | TERMINAL STUDS | MOUNTING STEM | | ACTUATOR | CONTACTS | INDEXING PIN | O-RING SEAL | TERMINAL SEAL | UL LISTED |
|--------------|----------|--------|---------|------------|--------------------------|--------------|----------------|---------------|-----------------------|----------|----------|--------------|-------------|---------------|-----------|
| BULK | BOXED | RETAIL | | CONTINUOUS | INTERMITTENT | | | MATERIAL | SIZE | | | | | | |
| 75908 | 75908-BX | - | 12V DC | 300A | 2000A (30s On-3m Off) | Plated Steel | Two 1/2"-20 | - | 3/4-16 17/32" long | Lever | Copper | | | • | |

Double-Pole Battery Switches



75900 Series • 125A • DPST • Double Pole Metal Body Battery Switches

Designed to disconnect the battery circuit and the alternator or generator field circuit on 6-36V DC systems.

- Mounting Stem: Brass, 3/4" -16 thread with one of two lengths:
 23/32" (18.3mm) long, fits panels up to 3/16" (4.8mm) thick
 17/32" (13.5mm) long, fits panels up to 1/4" (6.4mm) thick

- Torque: Mounting Stem 20 ft/lb max - 3/8" nuts 70-90 in-lbs

For datasheet, wiring diagram, and additional pack sizes visit: littelfuse.com/75900



2-position lever model



75903 / 75904



75904-02 / 75904-03



75912

| PART NUMBERS | | | VOLTAGE | AMPERAGE | | | CASE | TERMINAL STUDS | MOUNTING STEM | | ACTUATOR | CONTACTS | INDEXING PIN | O-RING SEAL | TERMINAL SEAL | UL LISTED |
|--------------|-------------|--------|----------|-------------|---------------------------|-------------|--------------|--------------------------|---------------|--------------|----------|----------|--------------|-------------|---------------|-----------|
| BULK | BOXED | RETAIL | | LARGE STUDS | | SMALL STUDS | | | MATERIAL | SIZE | | | | | | |
| | | | | CONTINUOUS | INTERMITTENT | CONTINUOUS | | | | | | | | | | |
| 75903 | 75903-BX | - | 6-36V DC | 125A | 1000A 15s On 5m Off | 20A | Plated Steel | Two 3/8"-24 Two 10-32 | Brass | Chrome Lever | Brass | | | | | |
| 75904 | 75904-BX | - | | | | | | | | | Silver | | | | | |
| 75904-01 | 75904-01-BX | - | | | | | | | | | Silver | • | • | • | | |
| 75904-02 | 75904-02-BX | - | | | | | | | | | Silver | • | | | | |
| 75904-03 | 75904-03-BX | - | | | | | | | | | Silver | • | • | | | |
| 75912 | 75912-BX | - | | | 750A 15s On 5m Off | - | | Four 3/8-24 | - | Chrome Lever | Silver | • | • | • | | |

Note: 75912 has epoxy seal at case, mounting stem and indexing pin. Operating Temp: -40° to 85°F

DPST Wiring Diagram



75912 Wiring Diagram (For two high current loads)



75907

75907 Series • 300A • DPST • Double Pole High Current Battery Switches

Designed to disconnect the battery circuit and the alternator or generator field circuit on 6-36V DC systems. Two positions: Off-On.

- Mounting Stem: 3/4" -16 thread, 23/32" (18.3mm) long, fits panels up to 3/16" (4.8mm) thick
- Torque: Mounting Stem 20 ft/lb max - 3/8" nuts 70-90 in-lbs

For datasheet, wiring diagram, and additional pack sizes visit: littelfuse.com/75907

| PART NUMBERS | | | VOLTAGE | AMPERAGE | | | CASE | TERMINAL STUDS | MOUNTING STEM | | ACTUATOR | CONTACTS | INDEXING PIN | O-RING SEAL | TERMINAL SEAL | UL LISTED |
|--------------|----------|--------|----------|-------------|--------------------------|-------------|--------------|----------------------------|---------------|----------------------|---------------|----------|--------------|-------------|---------------|-----------|
| BULK | BOXED | RETAIL | | LARGE STUDS | | SMALL STUDS | | | MATERIAL | SIZE | | | | | | |
| | | | | CONTINUOUS | INTERMITTENT | CONTINUOUS | | | | | | | | | | |
| 75907 | 75907-BX | - | 6-36V DC | 300A | 2000A (30s On-3m Off) | 20A | Plated Steel | Two 1/2"-20 & Two 10-32 | - | 3/4-16 23/32 long | Diecast Lever | Copper | • | • | | |

Marine Battery Switches



M-284 Series • 175A • SPST • Single Pole Brass Marine Battery Switches



M-284-01

Designed to disconnect the battery circuit on 6-36V DC systems.

- Mounting Stem: Brass, 3/4" -16 thread, 1 13/32" (46.1mm) long
fits panels up to 15/16" (23.8mm) thick
- Torque: Mounting Stem 20 ft/lb max - 3/8" nuts 70-90 in/lbs
- M-284-09BP includes Faceplate 82065
- Electrical ratings on UL labels are conservative

For additional information visit: littelfuse.com/M-284



2-position lever model

| PART NUMBERS | | | VOLTAGE | AMPERAGE | | CASE | TERMINAL STUDS | MOUNTING STEM | | ACTUATOR | CONTACTS | INDEXING PIN | O-RING SEAL | TERMINAL SEAL | UL LISTED | |
|--------------|-------------|-------------|----------|------------|--------------------------|-------|-----------------------|---------------|-------------------------|----------|----------|--------------|-------------|---------------|-----------|---|
| BULK | BOXED | RETAIL | | CONTINUOUS | INTERMITTENT | | | MATERIAL | SIZE | | | | | | | |
| M-284 | M-284-BX | M-284-BP | 6-36V DC | 175A | 1000A (15s On-5m Off) | Brass | Two 3/8" (9.5mm Ø) | Brass | 3/4-16 1 13/32" long | Lever | Copper | | | | | |
| M-284-A | M-284-A-BX | - | | | Lever | | | | | Silver | | | | | | |
| M-284-01 | M-284-01-BX | M-284-01-BP | | | 800A (15s On-5m Off) | | | | | Lever | Silver | | | | | • |
| M-284-02 | M-284-02-BX | - | | | Dichromate Lever | | | | | Silver | | • | • | | | |
| - | - | M-284-09-BP | | | Dichromate Lever | | | | | Silver | | • | • | | | |
| M-284-26 | - | - | | | Lever | | | | | Silver | | | | | | |
| - | M-289-BX | - | | | Lever | | | | | Silver | | | | | | |

*M-284-09-BP Kit includes M-284-02 Switch and 82065 Faceplate.

6

M-290 Series • 125A • DPST • Double Pole Brass Marine Battery Switches



M-290-05

Designed to disconnect the battery circuit and the alternator or generator field circuit on 6-36V DC systems. Two positions: Off-On.

- Mounting Stem: Brass, 3/4" -16 thread with 1 13/32" (46.1mm) long,
fits panels up to 15/16" (23.8mm) thick
- Torque: Mounting Stem 20 ft/lb max - 3/8" nuts 70-90 in-lbs
- M-290-05 is UL Listed to 707B

For datasheet, wiring diagram, and additional pack sizes visit: littelfuse.com/7590X

| PART NUMBERS | | | VOLTAGE | AMPERAGE | | | CASE | TERMINAL STUDS | MOUNTING STEM | | ACTUATOR | CONTACTS | INDEXING PIN | O-RING SEAL | TERMINAL SEAL | UL LISTED |
|--------------|-------------|--------|----------|-------------|--------------------------|-------------|-------|----------------------------|---------------|-------------------------|----------|----------|--------------|-------------|---------------|-----------|
| BULK | BOXED | RETAIL | | LARGE STUDS | | SMALL STUDS | | | MATERIAL | SIZE | | | | | | |
| | | | | CONTINUOUS | INTERMITTENT | CONTINUOUS | | | | | | | | | | |
| M-290 | M-290-BX | - | 6-36V DC | 125A | | | Brass | Two 3/8"-24 & Two 10-32 | Brass | 3/4-16 1 13/32" long | Lever | Silver | | | | |
| M-290-01 | M-290-01-BX | - | 6-36V DC | 125A | 1000A (15s On-5m Off) | 20A | | | | | | Silver | | • | | |
| M-290-05 | M-290-05-BX | - | 6-36V DC | 125A | | | | | | | | Silver | | | | • |

Battery Selector Disconnect Switches



M-750 • Dual Battery Selector / Master Disconnect Switch

For any vehicle that needs to use two batteries where one battery is used for starting the engine, while the other is used to power auxiliary loads. This is a common situation in trucks, boats, RVs, police and rescue vehicles, and in ambulances and fire equipment.

A selector switch allows use of the first battery, the second battery, or both batteries simultaneously. This provides back-up starting power in an emergency. Either or both batteries can be selected to supply power.

These switches combine the functions of Battery Selector and Master Disconnect Switches to give four battery power options:

- Power cut off at the source.
- Power On, Battery 1.
- Power On, Battery 2.
- Power On, both Batteries.

Electrical Ratings

Labeled UL 707B. Rating: 500A intermittent, 310A continuous, 6-36V DC
 Electrical ratings on UL labels are conservative. Use with either alternators or generators. Make before break design permits operation through the three On positions with the engines running. Engines should always be shut down before turning to Off. Wiring instructions are included.

Heavy-Duty Construction

- Vaporproof, weather-, dust- and corrosion-resistant.
- Durable, fracture-resistant high temperature plastic case, knob and insulator.
- Switches conform to USCG section 183.410 for ignition protection. Resistant to impact, and temperature extremes.
- Heavy duty copper stud terminals, with brass hexnuts. Can be surface mounted, or installed through a 3 5/16" diameter hole in the panel
- Dimensions: Flange: 6" (152.4mm) diameter, overall height 2 5/8" (66.7mm).
 Terminals: 3 copper studs, 3/8" (9.5mm) diameter.
- Alternator field disconnect circuit switch. Prevents possible alternator diode failure if the switch is accidentally turned to Off with the engines running.

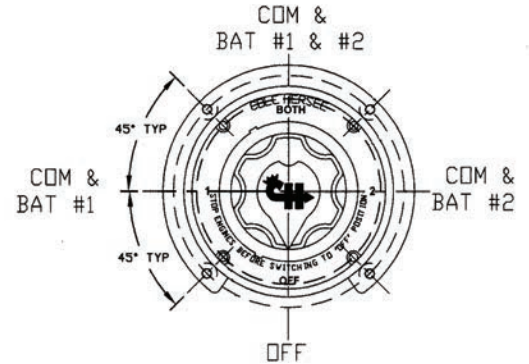

For datasheet, wiring diagram, and additional pack sizes visit: littelfuse.com/M750



M-750 Standard Switch



M-754 Back

M-754 Back is shown. Three small terminals in the middle are for connection to the pilot light circuit.

M-752 has two small terminals in the middle marked F1 and F2 for connection to the Alternator Field Disconnect circuit.

M-750 has no small terminals in the middle.

Full wiring instructions are included.

| PART NUMBERS | | | VOLTAGE | AMPERAGE | TERMINALS | MOUNTING TYPE | SEALING | CERTIFICATION | ALTERNATOR FIELD DISCONNECT | PILOT CIRCUIT |
|--------------|-------|------------------|----------|--------------------------------------|--|--|---|---------------|-----------------------------|---------------|
| BULK | BOXED | RETAIL CLAMSHELL | | | | | | | | |
| M-750 | - | M-750-BP | 6-36V DC | 500A intermittent 310A continuous | Copper Studs 3/8" (9.5mm) Brass hexnuts | Surface Mount Panel Mount (3 5/16" Ø hole) | Vaporproof, Weather-Resistant, Dust-Resistant, and Corrosion-Resistant | UL 707B | | • |
| M-754 | - | M-754-BP | | | | | | | | |

Metal Body Master Disconnect Switches - Accessories

Replacement levers, faceplates, terminal caps and lockout kits for Battery Disconnect Switches.



| PART NUMBERS | | | DESCRIPTION | DESCRIPTION |
|--------------|-------------|--------|-------------------|---|
| BULK | BOX | RETAIL | | |
| 24505 | 24505-BX | - | Lockout Lever Kit | Lever and flange plate accept a padlock to securely lock a Disconnect Switch in the Off position. For use with lever actuated switches with a 3/4" Ø diameter mounting stem. Use a padlock with a 5/16" Ø shackle |
| 24505-01 | - | - | Lever | Battery Disconnect Switch Lock Out Kit w/Mounting Panel and Lever |
| 80101-B | 80101-B-BX | - | Lever | Replacement chrome-plated diecast lever |
| 83353 | 83353-BX | - | Hencol Key | Replacement Hencol Key - Heavy gauge plated steel resists corrosion |
| 82065 | 82065-BX | - | Faceplate | Polished aluminum with enamel finish - 2 1/2" (63.5mm) Ø |
| 82065-02 | 82065-02-BX | - | Faceplate | With indexing hole - Polished aluminum with enamel finish - 2 1/2" (63.5mm) Ø |

Battery Jumper Terminals and Feeder Studs

Battery Jumper Terminals are used to make easily-accessible battery connections, inside or outside the vehicle. They can be used individually or in pairs and are easy to install. Featuring solid brass posts, including a brass hexnut and lockwasher.

Feeder Studs bring power through bulkheads or firewalls and feature an impact-resistant plastic insulator/mounting bushing.

6



| PART NUMBERS | | VOLTAGE | DESCRIPTION | COLOR | TERMINAL/STUD SIZE | DIMENSIONS | NOTES |
|--------------|-------------|----------|---------------|-------|-----------------------------|---------------------|--------------------------|
| BULK | BOXED | | | | | | |
| 46210-02 | 46210-02-BX | 6-48V DC | Terminal Post | Red | Terminal: 13/16" (20.6mm) Ø | - | Replacement Cap: 97846-A |
| 46210-03 | 46210-03-BX | 6-48V DC | Terminal Post | Black | 1-1/8" (29.9mm) long | - | Replacement Cap: 97846-B |
| 46211-R | 46211-R-BX | 6-36V DC | Feeder Stud | Red | Two 3/8" -16 threads | 1 17/64" (32.1mm) Ø | - |
| 46211-01 | 46211-01-BX | 6-36V DC | Feeder Stud | Black | 5/8" (15.9mm) long | 5/8" (15.9mm) long | - |



JBPT Single Stud Junction Blocks

Connection points for distribution of power in feed-thru and non-feed-thru styles. Simplifies cabling and serves as convenient tap points. Stainless steel studs of various threads and sizes, in red or black thermoplastic body. 3/8" zinc-plated steel studs have electrical rating of 400A and low resistance due to large contact area. High installation torque values allow the use of large cable sizes for high current applications.

| PART NUMBERS | | | COLOR | FEED TYPE | STUD SIZE | MOUNTING BASE |
|--------------|-------|--------|-------|---------------|-----------|---------------|
| BULK | BOXED | RETAIL | | | | |
| JBPT2P01ZX | - | - | Red | Feed-Thru | 1/2"-13 | 69.8 x 47.6mm |
| JBPT2N02ZX | - | - | Black | Non-Feed-Thru | 1/2"-13 | 69.8 x 47.6mm |
| JBPT3P01ZX | - | - | Black | Feed-Thru | 3/8"-18 | 52.4 x 19.1mm |
| JBPT3P02ZX | - | - | Black | Non-Feed-Thru | 3/8"-18 | 52.4 x 19.1mm |
| JBPT3N03ZX | - | - | Black | Feed-Thru | 3/8"-18 | - |
| JBPT0001Z | - | - | Red | Feed-Thru | - | - |

Ignition Switches



Littelfuse offers the broadest range of 12V to 48V Ignition Switches which are suitable for any application. Variations include those with plastic or traditional metal body, lever-actuated, tumbler keyed, or patented Hencol keyed.

Benefits of Anti-Restart Feature

Several ignition switches, including the 95060 series, feature an anti-restart mechanism. An operator can damage the starter motor if the ignition switch is inadvertently turned the when the engine is running. This can happen in noisy environments where it may be difficult to hear the engine. The switch must be turned to the Off position before the start circuit can be re-energized.

95060 – Not Just for Ignitions

The 95060 series is widely used in ignition systems. However, there are many other applications where a keyed, water-resistant rotary switch (two, three, or four positions) is required for 12V, 24V, or 36V systems

What is a Hencol Key?

Hencol is a Cole Hersee brand name used to describe our non-bitted common keys. Hencol keys are often used for ignition switches installed in forklifts or equipment that will have multiple operators. The non-bitted key allows any authorized user with a Hencol key to start and operator the vehicle.



The term Hencol is named after one of the Cole Hersee founders and is a mash-up of their name, Henry Cole.



Sealed Ignition Switches

95060 Series • 12-48V DC • Sealed Ignition Switches

Durable engineering thermoplastic construction withstands impact, and will not corrode, even on continual exposure to road salt. 95060 switches have integrated Deutsch-type connector for easy installs.

- Voltages: 10A at 12V, 5A at 24V, 3A at 36V and 2A at 48V
- Options: key boot, anti-restart, or spring return
- Sealing: contacts are sealed front and back to IP67 standard, with connector (p/n 31101) installed
- Ignition Protection: Tested to SAE J259 and UL-Recognized
- Deutsch connectors & Wires Part Number: 31101 (included in -50, -51 and -60 items)

- Actuators: single or multiple key codes, lever, knob or D-shaft.
 - Keyed switches ship with 2 keys (removable in Off position)
Replacement blanks: 83451-6 (600 series) or 83451-7 (700 series).
 - › CH601: Single tumbler code - all locks are identical
 - › Mixed: 200 random key codes
 - › 10 code: 10 random key codes
 - Lever: Chrome-plated diecast lever p/n 81254
 - Soft touch knob: p/n 81397
 - D-shaft: 1/4" D-shaft to accept customer's actuator

2D Prints and additional information: littelfuse.com/95060



95060 Series



95061 Series



95062 Series

| PART NUMBERS | | | TOTAL | POSITIONS | | | | ACTUATOR | KEYS | | HARNES | SPRING RETURN | ANTI-RESTART | SWITCH W/ HARNES (P/N 31101) | REPLACEMENT ACTUATOR OR KEY BLANK |
|--------------|-------------|-------------|----------|-----------|-----------|----------|-------|----------|----------|------|--------|---------------|--------------|------------------------------|-----------------------------------|
| BULK | BOXED | RETAIL | | 1 | 2 | 3 | 4 | | CODE | BOOT | | | | | |
| 95060 | 95060-BX | - | 4 | Acc | Off | Ign/Acc | Start | Keys | Mixed | • | • | • | | 83451-6 or 83451-7 | |
| 95060-01 | 95060-01-BX | - | | Acc | Off | Ign/Acc | Start | Keys | Mixed | • | • | • | | 83451-6 or 83451-7 | |
| 95060-02 | - | - | | Acc | Off | Ign/Acc | Start | Keys | Mixed | • | | | | 83451-6 or 83451-7 | |
| 95060-23 | 95060-23-BX | - | | Acc | Off | Ign/Acc | Start | Keys | CH601 | | | • | | 83451-6 | |
| 95060-24 | - | - | | Acc | Off | Ign/Acc | Start | Keys | CH601 | | | • | | 83451-6 | |
| 95060-34 | 95060-34-BX | - | | Acc | Off | Ign/Acc | Start | Keys | 10 Codes | | | • | | 83451-6 or 83451-7 | |
| - | - | 95060-50-BP | | Acc | Off | Ign/Acc | Start | Keys | 10 Codes | • | • | • | 95060 | 83451-6 or 83451-7 | |
| - | 95061-BX | - | | Acc | Off | Ign/Acc | Start | Lever | - | | | • | | 81254 | |
| - | 95061-50-BX | - | | Acc | Off | Ign/Acc | Start | Lever | - | | | • | | 81254 | |
| 95061-01 | - | - | | Acc | Off | Ign/Acc | Start | Lever | - | | | • | • | 81254 | |
| 95062-10 | - | - | Acc | Off | Ign/Acc | Start | Knob | - | | | • | | 81397 | | |
| - | 95062-50-BX | - | Acc | Off | Ign/Acc | Start | Knob | - | | | • | | 81397 | | |
| 95060-03 | 95060-03-BX | - | 3 | Off | Ign/Acc | Start | - | Keys | Mixed | • | • | | | 83451-6 or 83451-7 | |
| - | - | 95060-60-BP | | Off | Ign/Acc | Start | - | Keys | Mixed | • | • | • | 95060-03 | 83451-6 or 83451-7 | |
| 95060-04 | 95060-04-BX | - | | Off | Ign/Acc | Start | - | Keys | Mixed | • | • | • | | 83451-6 or 83451-7 | |
| 95060-21 | - | - | | Off | Ign/Acc | Start | - | Keys | 10 Codes | • | • | | | 83451-6 or 83451-7 | |
| 95060-26 | - | - | | Off | Ign/Acc | Start | - | Keys | CH601 | • | • | | | 83451-6 - no logo | |
| 95060-36 | - | - | | Mom On 1 | Off | Mom On 2 | - | Keys | CH545 | | | • | | Yale Y13 | |
| 95060-43 | - | - | | Mom On 1 | Off | Mom On 2 | - | Keys | Mixed | • | • | | | 83451-6 or 83451-7 | |
| 95061-04 | 95061-04-BX | - | | Off | Ign/Acc | Start | - | Lever | - | | | • | • | 81254 | |
| 95061-05 | - | - | | Off | Ign/Acc | Start | - | Lever | - | | | • | | 81254 | |
| - | 95061-60-BX | - | | Off | Ign/Acc | Start | - | Lever | - | | | • | • | 81254 | |
| 95061-36 | 95061-36-BX | - | Mom On 1 | Off | Mom On 2 | - | Lever | - | | | • | | 81254 | | |
| 95062-13 | - | - | Off | Ign/Acc | Start | - | Knob | - | | | • | | 81254 | | |
| 95060-07 | 95060-07-BX | - | 2 | Off | Ign/Acc | - | - | Keys | Mixed | • | | | | 83451-6 or 83451-7 | |
| 95060-29 | - | - | | Off | Ign/Acc | - | - | Keys | CH601 | • | | | | 83451-6 | |
| 95061-07 | - | - | | Off | Ign/Acc | - | - | Lever | - | | | | | 81254 | |
| 95062-17 | - | - | | Off | Ign/Start | - | - | Knob | - | | | | | 81397 | |
| - | 95062-57-BX | - | | Off | Ign/Start | - | - | Knob | - | | | • | | 81397 | |

Technical Details



Heavy Duty Ignition Switches

956 Series • Heavy Duty General Purpose Metal Body Ignition Switches

Dependable diecast zinc housing switches with an array of options for every application. Switches mount through the panel and have lever action or are keyed (hencol key or coded tumbler lock). On keyed switches the key is removable at Off position only.

- Two Terminal Options: Brass blade 1/4" (6.4mm) wide accept Delphi (Packard) connector 2962912 or equivalent
Screw Terminals include lock washers

- Two Mounting Sizes: 1"-24 bushings fit panels .030" - .090" (.76mm - 2.3mm)
3/4"-24 bushings fit panels .060" - .110" (1.5mm - 2.7mm)

2D Prints and additional information: littelfuse.com/IgnitionSwitches



Coded tumbler lock with 2 keys



Patented Hencol lock with 2 keys (83357)



Short handle lever (81254)



Military Lever (956-5109)

| PART NUMBERS | | | AMP RATING (12V DC) | | | | | POSITIONS | | | | ACTUATOR / KEY TYPE | TERMINALS | SPRING RETURN | ANTI-RESTART | GROUND TERMINAL | SEAL TYPE | | | BUSHING SIZE | REPLACEMENT KEY BLANK | |
|--------------|-------------|--------|---------------------|-----|-------|--------|-------|-----------|---------|-----------|-----------|---------------------|-----------|---------------|--------------|-----------------|-----------------|--------------|--------|--------------|-----------------------|------------------|
| BULK | BOXED | RETAIL | ACC | IGN | START | GROUND | TOTAL | 1 | 2 | 3 | 4 | | | | | | SILVER CONTACTS | SHUTTER LOCK | GASKET | | | O-RING |
| 956-4100 | 956-4100-BX | - | 10 | 10 | 5 | 1 | 4 | Acc | Off | Ign/Acc | Ign/Start | Coded | 4 blade | • | | | • | | | 1"-24 | Unavailable - OB | |
| 956-4107 | 956-4107-BX | - | 10 | 10 | 5 | 1 | | Acc | Off | Ign/Acc | Ign/Start | Hencol | 4 screw | • | | | • | • | • | 1"-24 | 83357 | |
| - | 956-4111-BX | - | 10 | 10 | 5 | 1 | | Acc | Off | Ign/Acc | Ign/Start | S. Lever | 4 blade | • | | | | | | 1"-24 | 81254 | |
| 956-4113 | - | - | 30 | 10 | 5 | - | | Acc | Off | Ign/Acc | Ign/Start | Hencol | 4 blade | • | | | • | | • | 1"-24 | 83357 | |
| 956-4124 | 956-4124-BX | - | 10 | 10 | 5 | 1 | | Acc | Off | Ign/Acc | Ign/Start | S. Lever | 4 screw | • | | | | • | • | 1"-24 | 81254 | |
| 956-4138 | 956-4138-BX | - | 30 | 20 | 10 | - | | Acc | Off | Ign/Acc | Ign/Start | Coded | 4 blade | • | | | | | | 1"-24 | Unavailable - OB | |
| 956-4141 | 956-4141-BX | - | 30 | 20 | 10 | - | | Acc | Off | Ign/Acc | Ign/Start | Hencol | 4 screw | • | | | • | • | • | 1"-24 | 83357 | |
| 956-4154 | 956-4154-BX | - | 10 | 10 | 5 | 1 | | Acc | Off | Ign/Acc | Ign/Start | Coded | 5 screw | • | | • | | • | | 1"-24 | Unavailable - OB | |
| 956-4307 | 956-4307-BX | - | 10 | 10 | 5 | 1 | | Acc | Off | Ign/Acc | Ign/Start | Hencol | 4 screw | • | | | • | • | • | 3/4"-24 | 83357 | |
| 956-4311 | 956-4311-BX | - | 10 | 10 | 5 | 1 | | Acc | Off | Ign/Acc | Ign/Start | Coded | 4 blade | • | | | | | • | 3/4"-24 | Unavailable - OB | |
| 956-9100 | 956-9100-BX | - | 10 | 5 | 5 | - | | Fuel | Off | Ign/Acc | Ign/Start | Hencol | 5 screw | • | | | | • | • | 1"-24 | 83357 | |
| 956-3122 | 956-3122-BX | - | 10 | 10 | 5 | - | 3 | Off | Ign/Acc | Ign/Start | - | Coded | 5 screw | • | • | • | | • | • | • | 1"-24 | Unavailable - OB |
| 956-3124 | 956-3124-BX | - | 10 | 10 | 5 | - | | Off | Ign/Acc | Ign/Start | - | S. Lever | 5 screw | • | • | • | | | • | 1"-24 | 81254 | |
| 956-3125 | 956-3125-BX | - | 30 | 10 | 10 | - | | Off | Ign/Acc | Ign/Start | - | Coded | 4 screw | • | • | | | | • | 1"-24 | Unavailable - OB | |
| 956-3126 | 956-3126-BX | - | 10 | 10 | 5 | - | | Off | Ign/Acc | Ign/Start | - | Hencol | 4 screw | • | • | | | | • | 1"-24 | 83357 | |
| 956-3127 | 956-3127-BX | - | 30 | 10 | 10 | - | | Off | Ign/Acc | Ign/Start | - | S. Lever | 3 screw | • | • | | | | • | 1"-24 | 81254 | |
| 956-3135 | - | - | 10 | 10 | 5 | 1 | | Off | Ign/Acc | Ign/Start | - | S. Lever | 5 screw | • | | | | | | 1"-24 | n/a | |
| 956-5109 | 956-5109-BX | - | 20 | 10 | 10 | - | | Off | Ign/Acc | Ign/Start | - | Mil. Lever | 4 screw | • | | | • | | • | 1"-24 | n/a | |
| 956-5124 | - | - | 10 | 10 | 5 | - | | Off | Ign/Acc | Ign/Start | - | Hencol | 4 screw | • | | | | | • | 3/4"-24 | 83357 | |
| 956-5307 | 956-5307-BX | - | 10 | 10 | 5 | 1 | | Acc | Off | Ign/Acc | - | Hencol | 3 screw | • | | | | | • | 3/4"-24 | 83357 | |
| 956-6307 | - | - | 10 | 10 | - | - | | Acc | Off | Ign/Acc | - | Hencol | 3 screw | • | | | | | • | 3/4"-24 | 83357 | |
| 956-6310 | - | - | 30 | 10 | - | - | | Acc | Off | Ign/Acc | - | Hencol | 3 screw | • | | | | | • | 3/4"-24 | 83357 | |

Typical Hencol Switch Dimensions



5 Screw Terminals

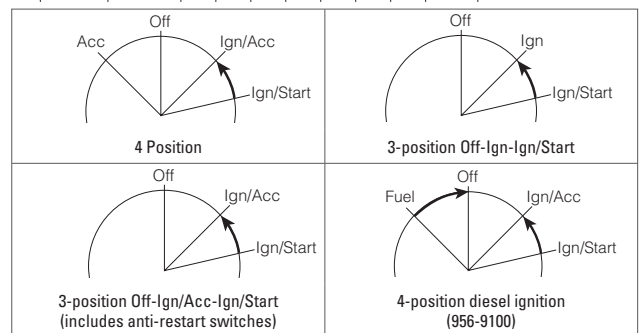
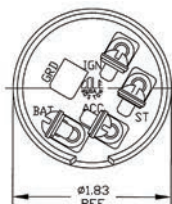

General Purpose Ignition Switches

95 Series • General Purpose Metal Body Ignition Switches



- Zinc diecast housing
- Coded tumbler locks (2 keys)
- Screw terminals with lock washers
- Fit panels up to 3/8" (9.5mm)
- Key removable at Off positions (except 9518)
- Spring return to IGN or IGN/ACC on all switches.† (except 9578)

2D Prints and additional information: littelfuse.com/IgnitionSwitches

| PART NUMBERS | | | AMP RATING (12V DC) | | | | POSITIONS | | | | ACTUATOR / KEY TYPE | TERMINALS | O-RING SEAL | BUSHING SIZE | NOTES | REPLACEMENT KEY BLANK |
|--------------|------------|---------|---------------------|-----|-------|-------|-----------|----------|-----------|-----------|---------------------|-----------|-------------|--------------|-----------------|-----------------------|
| BULK | BOXED | RETAIL | ACC | IGN | START | TOTAL | 1 | 2 | 3 | 4 | | | | | | |
| 9579 | 9579-BX | 9579-BP | 10 | 10 | 5 | 4 | Acc | Off | Ign/Acc | Ign/Start | Coded | 4 screw | | 3/4"-20 | - | - |
| 9579-02 | 9579-02-BX | - | 10 | 10 | 5 | 4 | Acc | Off | Ign/Acc | Ign/Start | Coded | 4 screw | | 3/4"-20 | Key code CH-505 | - |
| 9513 | 9513-BX | - | - | 10 | 5 | 3 | Off | Ign | Ign/Start | - | Coded | 3 screw | | 3/4"-20 | - | - |
| 9578 | 9578-BX | - | 10 | 10 | - | 3 | Acc | Off | Ign/Acc | - | Coded | 3 screw | | 3/4"-20 | - | - |
| 95539 | 95539-BX | - | 10 | 1 | 5 | 3 | Off | Run | Start | - | Coded | 4 screw | | 3/4"-20 | 1A Magneto | - |
| 95582 | 95582-BX | - | - | 10 | 5 | 3 | Off | Ign | Ign/Start | - | Coded | 3 screw | • | 3/4"-20 | - | - |
| 9577 | 9577-BX | - | 10 | - | - | 2 | Off | On (Ign) | - | - | Coded | 2 screw | | 3/4"-20 | - | - |
| 95535 | 95535-BX | - | 10 | 5 | 5 | - | Acc | Off | Ign/Acc | Ign/Start | Key | 4 screw | | 13/16" | - | - |
| 95593 | 95593-BX | - | 10 | 10 | - | - | Rev | Off | Run | - | Key | 3 screw | | 3/4" | - | - |

† Switch does not have a spring return to IGN or IGN/ACC feature.

95 Series • General Purpose Metal Body Ignition Switches



- Zinc diecast housing
- Military style lever
- Screw terminals with lock washers
- Fit panels up to 11/64" (4.4mm)
- Spring return to IGN or IGN/ACC on all switches

2D Prints and additional information: littelfuse.com/IgnitionSwitches

| PART NUMBERS | | | AMP RATING (12V DC) | | | | POSITIONS | | | | ACTUATOR / KEY TYPE | TERMINALS | O-RING SEAL | BUSHING SIZE | NOTES |
|--------------|-------------|--------|---------------------|-----|-------|-------|-----------|---------|-----------|---|---------------------|-----------|-------------|--------------|---|
| BULK | BOXED | RETAIL | ACC | IGN | START | TOTAL | 1 | 2 | 3 | 4 | | | | | |
| 95634-01 | 95634-01-BX | - | | 10 | 5 | 3 | Off | Ign | Ign/Start | - | Mil. Lever | 3 screw | • | 3/4"-20 | - |
| 95633-A | 95633-A-BX | - | 10 | 10 | | 2 | Off | Ign/Acc | - | - | Mil. Lever | 3 screw | | 3/4"-20 | Moisture & fungus-resistant per MIL-JAN-T-152 |

95 Series • General Purpose Metal Body Ignition Switches



- Plated steel housing
- Hencol locks (2 keys)
- Screw terminals with lock washers
- Fit panels up to 1/8" (3.2mm)
- Key removable at Off positions
- Spring return to IGN or IGN/ACC on all switches

2D Prints and additional information: littelfuse.com/IgnitionSwitches

| PART NUMBERS | | | AMP RATING (12V DC) | | | | POSITIONS | | | | ACTUATOR / KEY TYPE | TERMINALS | SILVER CONTACTS | O-RING SEAL | BUSHING SIZE | REPLACEMENT KEY BLANK |
|--------------|------------|--------|---------------------|-----|-------|-------|-----------|--------|-----------|-----------|---------------------|-----------|-----------------|-------------|--------------|-----------------------|
| BULK | BOXED | RETAIL | ACC | IGN | START | TOTAL | 1 | 2 | 3 | 4 | | | | | | |
| 95525-A | 95525-A-BX | - | 10 | 10 | 5 | 4 | Acc | Off | Ign/Acc | Ign/Start | Hencol | 4 screw | | • | 5/8"-32 | 83357 |
| 95524-A | 95524-A-BX | - | - | 10 | 5 | 3 | Off | Ign | Ign/Start | - | Hencol | 3 screw | | • | 5/8"-32 | 83357 |
| 95522-A | - | - | - | 10 | - | 2 | Off | On/Ign | - | - | Hencol | 2 screw | | • | 5/8"-32 | 83357 |

General Purpose Ignition Switches



95 Series • General Purpose Metal Body Ignition Switches

- Plated steel housing
- Lever actuator (short or long)
- Fit panels up to 1/8" (3.2mm)
- Spring return to IGN or IGN/ACC on all switches

2D Prints and additional information: littelfuse.com/IgnitionSwitches

| PART NUMBERS | | | AMP RATING (12V DC) | | | POSITIONS | | | ACTUATOR / KEY TYPE | TERMINALS | SILVER CONTACTS | O-RING SEAL | BUSHING SIZE | NOTES |
|--------------|----------|--------|---------------------|-------|-------|-----------|---------|-----------|---------------------|-----------|-----------------|-------------|--------------|--------------------|
| BULK | BOXED | RETAIL | IGN | START | TOTAL | 1 | 2 | 3 | | | | | | |
| 95591 | 95591-BX | – | 10 | 5 | 3 | Off | Ign/Acc | Ign/Start | Lever | 4 screw | • | • | 5/8"-32 | Zinc Diecast Lever |
| 95610 | 95610-BX | – | 25 | 20 | 3 | Off | Ign | Ign/Acc | Short Lever | 3 screw | • | • | 5/8"-32 | Short Chrome Lever |
| 95612 | 95612-BX | – | 25 | 20 | 3 | Off | Ign | Ign/Acc | Short Lever | 3 screw | • | • | 5/8"-32 | Short Chrome Lever |
| – | 95613-BX | – | 20 | 20 | 3 | Off | Ign | Ign/Acc | Short Lever | 3 blade | • | • | 5/8"-32 | Short Chrome Lever |



95 Series • General Purpose Metal Body Ignition Switches

- Plated steel housing
- Hencol locks come with 2 keys
- Screw terminals come with lock washers
- Fit panels up to 1/4" (6.4mm)
- Key removable at Off positions
- Spring return to IGN or IGN/ACC on all switches

2D Prints and additional information: littelfuse.com/IgnitionSwitches

7

| PART NUMBERS | | | AMP RATING (12V DC) | | | POSITIONS | | | ACTUATOR / KEY TYPE | TERMINALS | SILVER CONTACTS | O-RING SEAL | BUSHING SIZE | NOTES | REPLACEMENT KEY BLANK |
|--------------|-------------|--------|---------------------|-------|-------|-----------|----------|------------|---------------------|-----------|-----------------|-------------|--------------|-------------------|-----------------------|
| BULK | BOXED | RETAIL | IGN | START | TOTAL | 1 | 2 | 3 | | | | | | | |
| 95521-B | 95521-B-BX | – | 25 | 70 | 3 | Off | Ign | Start | Long Hencol | 3 screw | • | • | 5/8"-32 | – | 83353 |
| 95521-01 | 95521-01-BX | – | 25 | 70 | 3 | Off | Ign | Start | Lever | 3 screw | • | • | 5/8"-32 | Dichromate Lever | 80101-A |
| 95033 | 95033-BX | – | 50 | 10 | 3 | Glow | Off | Glow/Start | Lever | 3 screw | • | • | 5/8"-32 | 50A Glow - Diesel | 80101-A |
| 95597 | 95597-BX | – | 50 | – | 2 | Off | On (Ign) | – | Long Hencol | 2 screw | • | • | 5/8"-32 | Heavy-Duty | 83353 |
| M-288 | M-288-BX | – | 50 | – | 2 | Off | On (Ign) | – | Lever | 2 screw | • | • | 5/8"-32 | Heavy-Duty | – |



Level Lock Ignition Switch (9500)



Coded tumbler lock with 2 keys (9622-01)

5A-10A Compact Ignition Switches

- Key removable at Off and On
- 3/4" -24 mounting stem fits panels to 3/4" (19.1mm)
- Compact - Plated steel case, stainless steel bezel & face washer

| PART NUMBERS | | | RATING | POSITIONS | | | ACTUATOR / KEY TYPE | TERMINALS | MOUNTING STEM |
|--------------|------------|--------|---------------|-----------|-----|----------|---------------------|-----------|---------------------------------------|
| BULK | BOXED | RETAIL | | TOTAL | 1 | 2 | | | |
| 9500 | 9500-BX | – | 10A at 12V DC | 2 | Off | On (Ign) | Lever | 2 screw | 1/2"-20 fits panels to 13/64" (5.2mm) |
| 9622-01 | 9622-01-BX | – | 5A at 12V DC | 2 | Off | On (Ign) | Tumbler Key Coded | 2 screw | 3/4"-24 |



10A Reversing Switch with Tumbler Key

Reversing Switch in a plated steel case. Key is removable in Off position only with Spring return to Off. O-ring seal in mounting stem.



| PART NUMBERS | | | RATING | POSITIONS | | | ACTUATOR / KEY TYPE | TERMINALS | BUSHING SIZE | |
|--------------|-------------|--------|---------------|-----------|-------------|-----|---------------------|-----------|--------------|-----------|
| BULK | BOXED | RETAIL | | TOTAL | 1 | 2 | | | | 3 |
| 75705-01 | 75705-01-BX | – | 10A at 12V DC | 3 | Mom Forward | Off | Mom Reverse | Coded | 3 screw | 13/16"-24 |



M-712 • M-550 • M-489



M-712-09 • M-550-14

Marine or General Purpose Brass Body Keyed Ignition Switches

Marine switches are highly suitable for harsh environments on land or at sea. They are corrosion-resistant, with brass cases. Moisture-repellent insulators, coded locks with 2 brass keys.

- Brass housing and mounting hardware, chrome-plated brass facenut.
- Coded tumbler locks (2 keys)
- Screw terminals with lock washers
- Fit panels up to 1" (25.4mm)
- Key removable at Off positions
- Spring return to IGN or IGN/ACC on all switches

2D Prints and additional information: littelfuse.com/IgnitionSwitches

| PART NUMBERS | | | AMP RATING (12V DC) | | | | POSITIONS | | | | ACTUATOR / KEY TYPE | TERMINALS | BUSHING SIZE | NOTES | REPLACEMENT KEY BLANK |
|--------------|-------------|-------------|---------------------|-----|-------|-------|-----------|--------|-----------|-----------|---------------------|-----------|--------------|--------------------|-----------------------|
| BULK | BOXED | RETAIL | ACC | IGN | START | TOTAL | 1 | 2 | 3 | 4 | | | | | |
| M-6110-05 | - | - | - | 10 | 5 | 3 | Off | Ign | Ign/Start | - | Coded Key | 3 screw | 13/16"-24 | Bitted CH-523 Code | |
| M-700 | M-700-BX | - | - | 5 | 5 | 4 | Acc | Off | Ign/ACC | Ign/Start | Coded Key | 4 screw | 3/4" | Bitted Mixed Codes | |
| M-712 | M-712-BX | M-712-BP | 10 | 5 | 5 | 4 | Acc | Off | Ign/ACC | Ign/Start | Coded Key | 4 screw | 13/16"-24 | | |
| M-712-09 | M-712-09-BX | M-712-09-BP | 10 | 5 | 5 | 4 | Acc | Off | Ign/ACC | Ign/Start | Coded Key | 4 screw | 13/16"-24 | Rubber Boot | |
| M-550 | M-550-BX | M-550-BP | - | 10 | 5 | 3 | Off | Ign | Ign/Start | - | Coded Key | 3 screw | 13/16"-24 | | |
| M-550-14 | M-550-14-BX | M-550-14-BP | - | 10 | 5 | 3 | Off | Ign | Ign/Start | - | Coded Key | 3 screw | 13/16"-24 | Rubber Boot | |
| M-489 | M-489-BX | M-489-BP | - | 10 | - | 2 | Off | On/Ign | - | - | Coded Key | 2 screw | 13/16"-24 | | |
| M-489-03 | - | - | - | 10 | - | 2 | Off | On/Ign | - | - | Coded Key | 2 screw | 13/16"-24 | Keyhole shutter | |



M-497

Marine or General Purpose Brass Body Lever Ignition Switches

Marine switches are highly suitable for harsh environments on land or at sea. They are corrosion-resistant, with brass cases.

- Brass housing and mounting hardware, chrome-plated diecast long lever.
- Fit panels up to 7/8" (22.2mm)

2D Prints and additional information: littelfuse.com/IgnitionSwitches

| PART NUMBERS | | | AMP RATING (12V DC) | | POSITIONS | | ACTUATOR / KEY TYPE | TERMINALS | BUSHING SIZE |
|--------------|----------|--------|---------------------|-------|-----------|--------|---------------------|-----------|--------------|
| BULK | BOXED | RETAIL | IGNITION | TOTAL | 1 | 2 | | | |
| M-497 | M-497-BX | - | 10 | 2 | Off | On/Ign | Lever | 2 screw | 1/2'-20 |



M-850

15A Marine Plastic Body Ignition Switches

Durable plastic case and stem with PVC boot for added weather protection. Key is removable only in the Off position. Off-Run-Start Spring return to IGN.

- Electrical ratings at 6-36V DC: 15A ignition, 5A start
- Mounting stem fits panels up to 7/8" (22.2mm) thick, with 7/8" diameter hole

2D Prints and additional information: littelfuse.com/IgnitionSwitches

| PART NUMBERS | | | POSITIONS | | | ACTUATOR | TERMINALS | SPRING RETURN | MOUNTING STEM | REPLACEMENT KEY |
|--------------|----------|----------|-----------|-----|-----------|----------|-----------|---------------|---|-----------------|
| BULK | BOXED | RETAIL | 1 | 2 | 3 | | | | | |
| M-850 | M-850-BX | M-850-BP | Off | Run | Ign/Start | Key | 3 screw | • | Fits panels to 7/8" (22.2mm) with 7/8" Ø hole | - |

Ignition Switches

Delco Replacement Ignition and Start Switches

Replacement switches sold without a lock cylinder. To receive a new lock cylinder and 2 keys order part number 95874. Both part numbers feature a 1"-24 UNS-2A thread and key is only removable in Off position.



- 7 Blade Terminals accept Delphi (Packard) 6288702. Includes 2 ground terminals for checking indicator bulbs. 1 additional battery terminal provides continuous hotfeed for optional equipment.
- Replaces Delco D-1403-A, D-1406-A, D-1480, D-1498-A, • Chevrolet Trucks 67-83, 85-89, GMC 1116712, 1116683, 1116695, 1116704, 1116709, 1116711, 2234285 • GMC Trucks 67-83, 85-89

2D Prints and additional information: littelfuse.com/IgnitionSwitches

| PART NUMBERS | | | POSITIONS | | | | ACTUATOR | TERMINALS | SPRING RETURN | GROUND TERMINAL | O-RING |
|--------------|-------|--------|-----------|-----|---------|------------------|----------|-----------|---------------|-----------------|--------|
| BULK | BOXED | RETAIL | 1 | 2 | 3 | 4 | | | | | |
| 95410 | - | - | Acc | Off | Ign/Acc | Ign/Start/Ground | None | 7 screw | • | • | • |

Ignition Switch Keys, Protective Boots, Caps, Facenuts and Cover Accessories

7



83353 - Long Hencol Key



83357 - Short Hencol Key



83379 - 500 Series Blank Tumbler Key



83285-01 & 83288 - Protective Boot



8367 - Face nut



98635-01 - Key Cover

| PART NUMBERS | | | MATERIAL | DESCRIPTION |
|--------------|----------|----------|--------------------------|---|
| BULK | BOX | RETAIL | | |
| 31101 | 31101-BX | - | Harness | Harness populated with Wires that mates to the 95060 Series Switches |
| 83353 | 83353-BX | - | Heavy Gauge Steel Plated | Hencol L Long Key |
| 83357 | 83357-BX | - | Heavy Gauge Steel Plated | Hencol S Short Key |
| 83274 | - | - | Aluminum | Face Nut |
| 83379 | 83379-BX | - | Brass | Design for 95 Series & M-XXX Marine Switches |
| 83285-01 | - | - | Aluminum | Mounting nut containing a rubber self-closing key slot - 3/4"-20 threads 7/16" thick |
| - | 83288-BX | 83288-BP | Chrome Brass | Mounting nut containing a rubber self-closing key slot - 13/16"-24 thread 7/32" thick |
| 8367 | 8367-BX | - | Aluminum | Face Nut Knurled Edges - 3/4"-20 thread 19/64" thick - Clears 5/8" Hole |
| 98635-01 | - | - | Plastic | Black Slip-On Cover for Tumbler Keys 83379 |

Anti-Restart Ignition Switches

What Are They, and Where Should They Be Used?



The 95060 and 956 Series Ignition Switches include an Anti-Restart safety feature. On occasion, vehicle operators do not realize the engine is running and turn on the ignition resulting in a squealing and grinding of gears. If this happens repeatedly, the starter motor will likely burn out. Cole Hersee Anti-Restart Ignition Switches prevent this from happening.



95060

How They Work

Most regular Ignition Switches have three positions.



Off: key can be removed. Ignition and accessories (radio, lights etc) are activated when the key is in.

Momentary Start position runs the starter motor. This position is spring-loaded to return to position 2 once the engine is running. If the Ignition Switch is in position 2 and you think it's in position 1, you may be tempted to turn it to position 3 while thinking it is in position 2. This results in the grinding sound. Cole Hersee Anti Restart Ignition Switches prevent the operator from turning to Position 3 when the engine is

running. This safeguard against burnt-out motors can be retrofitted into any kind of vehicle, such as forklifts or mining vehicles where the ambient noise is high. This kind of 'lockout ignition' is available with a standard ignition key or with a lever for off-road applications.

For additional information, 2D Prints and more: littelfuse.com/IgnitionSwitches



956-3122



95061



956-3124



95062

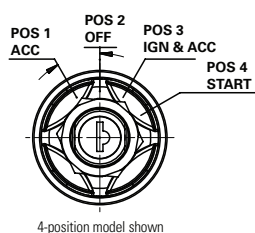

TERMINALS
1 = Battery
2 = Start
3 = Accessory
4 = Ignition
5 = Ignition
6 = Battery
Terminals 1 and 6 are connected internally.
Terminals 4 and 5 are connected internally.

Rocker Switches



What is Dependent and Independent Illumination?

Dependent:

The actuator is illuminated only when the switch is turned on.

Independent:

Illumination is not affected by the actuation of the switch. The illumination can be switched on or off by another switch, such as headlight or interior lighting controls. This is especially useful when locating switches in the dark.



What Does SPST or DPST Mean?

The first two letters, SP or DP, refer to single pole or double pole. The second two letters, ST or DT refer to single throw or double throw.

Pole refers to the number of circuits controlled by the switch. SP switches control one circuit and DP switches control two independent circuits (which act like two identical switches that are mechanically linked). Pole is often confused with terminal, which is a common mistake. Terminals are used for wire connections on the back of the unit and are specified separately.

Throw refers to the extreme position of the actuator. ST switches close a circuit at only one position and the other position is off. DT switches close a circuit in the Up position, as well as the down position and can be configured with two positions (On-On) or three positions (On-Off-On).



Sealed Rocker Switches

25A LED Sealed Rocker Switches

- Weather-resistant with contact areas sealed to IP66 (high pressure wash resistant)
- Super-bright LED illumination and high-visibility wrap-around lenses
- LEDs give visibility, even in sunlight and have a long life
- Silver contacts and corrosion-resistant nickel-plated brass blades for superior performance and electrical contact

2D Prints and additional information: littelfuse.com/RockerSwitches



58312-A2 & A4



58312-R2 & R4



58312-C4



58312-G4



58312-AG

| PART NUMBERS | | | RATING | POLE & THROW | ACTION | ILLUMINATION | LED PILOT LIGHTS | | TERMINALS | CONTACTS | SEALING |
|--------------|-------------|------------------|---------------|--------------|-----------|--------------|------------------|--------------|-----------|----------|---------|
| BULK | BOXED | RETAIL CLAMSHELL | | | | | LENS COLOR 1 | LENS COLOR 2 | | | |
| 58312-R2 | - | - | 25A at 12V DC | SPST | On-Off | Independent | Red | - | 4 blade | Silver | IP66 |
| 58312-A4 | 58312-A4-BX | - | 25A at 12V DC | SPST | On-Off | Dependent | Amber | - | 3 blade | Silver | IP66 |
| 58312-C4 | - | - | 25A at 12V DC | SPST | On-Off | Dependent | Clear | - | 3 blade | Silver | IP66 |
| 58312-G4 | 58312-G4-BX | - | 25A at 12V DC | SPST | On-Off | Dependent | Green | - | 3 blade | Silver | IP66 |
| 58312-R4 | 58312-R4-BX | - | 25A at 12V DC | SPST | On-Off | Dependent | Red | - | 3 blade | Silver | IP66 |
| 58312-AG | 58312-AG-BX | - | 25A at 12V DC | SPDT | On-Off-On | Dependent | Amber | Green | 4 blade | Silver | IP66 |

Note: 24V DC versions can be made available for volume exceeding 1000 pieces. Please contact Littelfuse for more details.



25A & 15A Non-Illuminated Sealed Rocker Switches

- Weather-resistant with contact areas sealed to IP66 (high pressure wash resistant)
- Silver contacts and corrosion-resistant nickel-plated brass blades for superior performance and electrical contact

| PART NUMBERS | | | RATING | POLE & THROW | ACTION | TERMINALS | CONTACTS | SEALING | NOTES |
|--------------|-------------|------------------|--------------------------------|--------------|-------------------|-----------|----------|---------|--|
| BULK | BOXED | RETAIL CLAMSHELL | | | | | | | |
| 58311-01 | - | - | 25A at 12V DC 15A at 24V DC | SPST | On-Off | 2 blade | Silver | IP66 | |
| 58311-02 | - | - | | SPST | Mom On-Off | 2 blade | Silver | IP66 | |
| 58311-07 | - | - | | DPDT | On-Off-On | 6 blade | Silver | IP66 | |
| 58311-08 | - | - | | DPDT | On-On | 6 blade | Silver | IP66 | |
| 58311-11 | - | 58311-11-BP | | DPDT | On-Off-On | 4 blade | Silver | IP66 | Forward & Reverse |
| 58311-13 | 58311-13-BX | - | | DPDT | Off-On-Mom On | 4 blade | Silver | IP66 | Ignition & Start |
| 58311-18 | - | 58311-18-BP | | DPDT | Mom On-Off-Mom On | 4 blade | Silver | IP66 | Forward & Reverse |
| 58336 | - | - | | SPST | On-Off (Lockable) | 2 blade | Silver | IP66 | Black Rocker and Orange Lock |
| 58337 | - | - | | DPDT | Open-Off-Close | 2 blade | Silver | IP66 | Black Rocker with White Text "Open - TARP - Close" |

Sealed Rocker Switches



58328-01



58328-02

58328 Series • 25A Incandescent Pilot Light Rocker Switches

- Series available with small pilot lights, large pilot lights or unlit
- Dependent or independent illumination
- Faceted lenses are on the actuator
- Matte black finish on the plastic housing, bezel and actuator
- Brass blade or screw terminals available
- See accessories section for bezels and mounting kits



Standard mounting hole

2D Prints and additional information: littelfuse.com/RockerSwitches

| PART NUMBERS | | | RATING | POLE & THROW | ACTION | ILLUMINATION | LED PILOT LIGHTS | | TERMINALS | CONTACTS | SEALING |
|--------------|-------------|------------------|---------------|--------------|-----------|--------------|------------------------|--------------|-----------|----------|---------|
| BULK | BOXED | RETAIL CLAMSHELL | | | | | LENS COLOR 1 | LENS COLOR 2 | | | |
| 58328-01 | 58328-01-BX | – | 25A at 12V DC | SPST | On-Off | Independent | Red | – | 4 blade | Silver | IP66 |
| 58328-02 | – | – | | SPST | On-Off | Independent | Green | – | 4 blade | Silver | IP66 |
| – | – | 58328-101-BP | | SPST | On-Off | Independent | One lens of each color | – | 4 blade | Silver | IP66 |
| 58328-04 | 58328-04-BX | – | | SPST | On-Off | Dependent | Red | – | 3 blade | Silver | IP66 |
| 58328-11 | 58328-11-BX | – | | SPST | On-Off | Dependent | Green | – | 3 blade | Silver | IP66 |
| – | 58328-12-BX | – | | SPST | On-Off | Dependent | Clear | – | 3 blade | Silver | IP66 |
| 58328-13 | 58328-13-BX | – | | SPST | On-Off | Dependent | Amber | – | 3 blade | Silver | IP66 |
| 58328-55 | – | – | | SPST | On-Off | Dependent | Blue | – | 3 blade | Silver | IP66 |
| 58328-58 | – | – | | SPST | On-Off | Dependent | Red | – | 3 blade | Silver | IP66 |
| 58328-62 | – | – | | SPST | On-Off | Dependent | Amber | – | 3 blade | Silver | IP66 |
| – | – | 58328-100-BP | | SPST | On-Off | Dependent | One lens of each color | – | 3 blade | Silver | IP66 |
| 58328-35 | 58328-35-BX | – | | SPDT | On-Off-On | Dependent | Red | Amber | 4 blade | Silver | IP66 |
| – | – | 58328-103-BP | | SPDT | On-Off-On | Dependent | One lens of each color | – | 4 blade | Silver | IP66 |

58332 Series • 20A Sealed Rocker Switches

58332 switches are supplied in retail BP only and are supplied with one black and one gray snap-on actuator. These general-purpose switches are suitable for all kinds of applications.

- They are weather-resistant with contact areas sealed to IP66 (high pressure wash-resistant).
- Recognized at UL 1500 (Ignition protection for marine products). With neoprene gasket/panel seal.
- Conveniently snap into a standard rectangular mounting hole 1.48" x 0.83" (36.8 x 21.1mm) in panels from 0.09" to 0.19" thick (2.4 x 4.7mm).
- Plastic housing, bezel and actuator.
- Silver contacts, Brass blade terminals.

2D Prints and additional information: littelfuse.com/RockerSwitches

| PART NUMBERS BOXED | RATING | POLE & THROW | ACTION | ILLUMINATION | LED PILOT LIGHTS | | TERMINALS | CONTACTS | SEALING |
|-----------------------|---------------|--------------|-------------------|--------------|------------------|--------------|-----------|----------|----------------|
| | | | | | LENS COLOR 1 | LENS COLOR 2 | | | |
| 58332-04-BP | 25A at 12V DC | SPST | On-Off | Independent | Green | Red | 4 Blade | Silver | UL1500 IP66 |
| 58332-20-BP | | SPST | Mom On-Off | | – | – | 2 Blade | | |
| 58332-21-BP | | SPDT | On-Off-On | | Amber | Amber | 4 Blade | | |
| 58332-22-BP | | SPDT | Mom On-Off-Mom On | | – | – | 3 Blade | | |
| 58332-23-BP | | SPDT | On-Off-Mom On | | Amber | – | 3 Blade | | |
| 58332-25-BP | | DPDT | On-Off-Mom On | | Amber | – | 7 Blade | | |
| 58332-26-BP | | DPDT | On-Off-On | | Amber | Amber | 7 Blade | | |
| 58332-27-BP | | DPDT | Mom On-Off-Mom On | | – | – | 6 Blade | | |
| 58332-28-BP | | DPST | Mom On-Off | | – | – | 5 Blade | | |
| 58332-29-BP | | DPST | On-Off | | Amber | – | 5 Blade | | |
| 58332-30-BP | | SPDT | On-Off-On | | Amber | Amber | 4 Blade | | |
| 58332-31-BP | | SPDT | On-Off-Mom On | | Amber | – | 4Blade | | |
| 58332-32-BP | | DPDT | On-Off-Mom On | | Amber | – | 7 Blade | | |
| 58332-33-BP | | DPDT | On-Off-On | | Amber | Amber | 7Blade | | |
| 58332-34-BP | | DPDT | On-Off | | Amber | – | 5Blade | | |

Sealed Rocker Switches

56327 & 58327 Series • 25A Small Round Lens Pilot Light Rocker Switches



56327-01



58327-06

- Series available with small pilot lights, large pilot lights or unlit
- Dependent or independent illumination
- Faceted lenses are on the actuator
- Matte black finish on the plastic housing, bezel and actuator
- Brass blade or screw terminals available
- See accessories section for bezels and mounting kits

2D Prints and additional information: littelfuse.com/RockerSwitches

| PART NUMBERS | | | RATING | POLE & THROW | ACTION | ILLUMINATION | LED PILOT LIGHTS | | TERMINALS | CONTACTS | SEALING | DIAGRAM page 82 |
|--------------|-------------|------------------|---------------|--------------|-----------|--------------|------------------|--------------|-----------|----------|---------|--------------------|
| BULK | BOXED | RETAIL CLAMSHELL | | | | | LENS COLOR 1 | LENS COLOR 2 | | | | |
| 56327-01 | 56327-01-BX | 56327-01-BP | 25A at 12V DC | SPST | On-Off | Dependent | Red | | 3 screw | Silver | IP66 | F |
| 58327-01 | 58327-01-BX | 58327-01-BP | | SPST | On-Off | Dependent | Red | | 3 blade | Silver | IP66 | F |
| 58327-06 | 58327-06-BX | 58327-06-BP | | SPDT | On-Off-On | Dependent | Red | Red | 4 blade | Silver | IP66 | J |



56027-01

56027 & 58027 Series • 25A Non-Illuminated Rocker Switches

- Series available with small pilot lights, large pilot lights or unlit
- Matte black finish on the plastic housing, bezel and actuator
- Brass blade or screw terminals available
- See accessories section for bezels and mounting kits

2D Prints and additional information: littelfuse.com/RockerSwitches



Forward-Reverse switch

| PART NUMBERS | | | RATING | POLE & THROW | ACTION | TERMINALS | CONTACTS | SEALING | NOTES |
|--------------|-------------|------------------|---------------|--------------|-------------------|-----------|----------|---------|-------------------|
| BULK | BOXED | RETAIL CLAMSHELL | | | | | | | |
| 56027-01 | 56027-01-BX | 56027-01-BP | 25A at 12V DC | SPST | On-Off | 2 screw | Silver | IP66 | - |
| 58027-01 | 58027-01-BX | - | | SPST | On-Off | 2 blade | Silver | IP66 | - |
| 58027-02 | 58027-02-BX | 58027-02-BP | | SPST | Mom On-Off | 2 blade | Silver | IP66 | - |
| 58027-03 | 58027-03-BX | 58027-03-BP | | SPDT | On-Off-On | 3 blade | Silver | IP66 | - |
| 58027-04 | 58027-04-BX | 58027-04-BP | | SPDT | Mom On-Off-Mom On | 3 blade | Silver | IP66 | - |
| 58027-06 | 58027-06-BX | - | | DPST | On-Off | 4 blade | Silver | IP66 | - |
| 58027-07 | 58027-07-BX | 58027-07-BP | | DPDT | On-Off-On | 6 blade | Silver | IP66 | - |
| 58027-08 | - | - | | DPDT | On-On | 6 blade | Silver | IP66 | - |
| 58027-11 | 58027-11-BX | 58027-11-BP | | DPDT | Mom On-Off-Mom On | 6 blade | Silver | IP66 | - |
| 58027-18 | 58027-18-BX | - | | DPDT | Mom On-Off-Mom On | 4 blade | Silver | IP66 | Forward & Reverse |

Dual & Wide Body Rocker Switches

25A Wide Body Dual Rocker Switches



- Two Single Pole switches in one body
- Universal application switches
- Snap-in mounting
- Silver contacts, copper blade terminals
- Black or white actuators, imprinted in contrasting black or white
- Snaps into panel hole 1.0" x 1.125" (25.4x28.6mm) and fits panels .030" thru .250" thick (.76 - 6.35mm)

2D Prints and additional information: littelfuse.com/RockerSwitches

| PART NUMBERS | | | RATING | LEFT SWITCH | | | RIGHT SWITCH | | | TERMINALS | BEZEL WIDTH |
|--------------|-------|------------------|---------------|-------------|--------------|--------|--------------|--------------|--------|-----------|-------------|
| BULK | BOXED | RETAIL CLAMSHELL | | ACTION | ACTUATOR | PRINT | ACTION | ACTUATOR | PRINT | | |
| 54204-01 | - | - | 10A at 12V DC | On1-Off-On2 | Black Rocker | Hi, Lo | On1-Off-On2 | Black Rocker | Hi, Lo | 6 Blade | Wide |

Sealed Rocker Switches



M-58031 Series • 20A Rocker Switches

- Certified to IP66 for protection against dust and prolonged spray
- Recognized at UL 1500: Ignition Protection for Marine Products
- Neoprene gasket/panel seal with black nylon bezel and black plastic housing
- 20A at 12V DC. Blade terminals, silver contacts

2D Prints and additional information: littelfuse.com/RockerSwitches

| PART NUMBERS | | | RATING | POLE & THROW | ACTION | TERMINALS | CONTACTS | SEALING |
|--------------|---------------|------------------|---------------|--------------|-------------------|-----------|----------|---------|
| BULK | BOX | RETAIL CLAMSHELL | | | | | | |
| M-58031-01 | M-58031-01-BX | M-58031-01-BP | 20A at 12V DC | SPST | On-Off | 2 Blade | Silver | IP66 |
| M-58031-02 | – | M-58031-02-BP | 20A at 12V DC | SPDT | On-Off-On | 3 Blade | Silver | IP66 |
| M-58031-04 | – | M-58031-04-BP | 20A at 12V DC | DPST | On-Off | 4 Blade | Silver | IP66 |
| M-58031-07 | – | M-58031-07-BP | 20A at 12V DC | SPST | Mom On-Off | 2 Blade | Silver | IP66 |
| M-58031-08 | – | – | 20A at 12V DC | SPDT | Mom On-Off-Mom On | 3 Blade | Silver | IP66 |
| M-58031-09 | M-58031-09-BX | – | 20A at 12V DC | DPDT | Mom On-Off-Mom On | 6 Blade | Silver | IP66 |

58326 Series • 20A Rocker Switches with Pilot Lights

Single or dual pilot lights. Faceted lenses inset into the actuator. Matte black plastic housing, bezel and actuator. Silver contacts. Internal seal.

- Certified to IP66 for protection against dust and prolonged spray
- Neoprene gasket/panel seal with black nylon bezel and black plastic housing
- 20A at 12V DC. Blade terminals, silver contacts
- Other imprints available upon request. Contact Littelfuse for details

2D Prints and additional information: littelfuse.com/RockerSwitches



58326-01



58326-06



58326-11

| PART NUMBERS | | RATING | POLE & THROW | ACTION | ILLUMINATION | LED PILOT LIGHT | IMPRINT | | TERMINALS | CONTACTS | SEALING |
|--------------|-------------|---------------|--------------|---------------|--------------|-----------------|---------------------------------------|-----------------|-----------|----------|---------|
| BULK | BOX | | | | | | ACTUATOR | LENS SYMBOL | | | |
| – | 58326-01-BX | 20A at 12V DC | SPST | Off-On | Independent | Red | None | None | 4 Blade | Silver | IP66 |
| 58326-06 | – | 20A at 12V DC | SPDT | On-Off-Mom On | Independent | Red | Override - LVD Auto Mode - System Off | Battery | 5 Blade | Silver | IP66 |
| 58326-11 | 58326-11-BX | 20A at 12V DC | DPST | Off-On-Mom On | Independent | White | Amber - Warning (On) - Off | SAE lamp symbol | 6 Blade | Silver | IP66 |
| 58326-15 | – | 20A at 12V DC | SPST | On-Off | Independent | White | On-Interior-Off | Dome Light | 4 Blade | Silver | IP66 |
| 58326-27 | 58326-27-BX | 20A at 12V DC | DPDT | On-On-On | Independent | White | Lo/Hi-Pass Heater-Off | Fan | 8 Blade | Silver | IP66 |
| 58326-29 | 58326-29-BX | 20A at 12V DC | DPDT | On-On-On | Independent | White | Lo/Hi-Fan-Off | Fan | 8 Blade | Silver | IP66 |



10A Narrow Body Curved Rocker Switches

- Curved matte finish narrow body rocker switches
- Fits panels .025" through .200" (.64 to 5.2mm)
- Universal application switches
- Snap-in mounting

2D Prints and additional information: littelfuse.com/RockerSwitches

| PART NUMBERS | | | RATING | POLE & THROW | ACTION | TERMINALS | ACTUATOR | |
|--------------|----------|------------------|---------------|--------------|--------|-----------|------------------------|--------------------|
| BULK | BOXED | RETAIL CLAMSHELL | | | | | COLOR | ILLUMINATION |
| 54003 | 54003-BX | – | 10A at 12V DC | SPST | On-Off | 3 Blade | Red | – |
| 54007 | – | 54007-BP | 10A at 12V DC | SPDT | On-On | 3 Blade | Black Face - Red Edges | – |
| 54010 | 54010-BX | – | 10A at 12V DC | SPDT | On-On | 3 Blade | Black | – |
| 54012 | 54012-BX | – | 10A at 12V DC | SPST | Off-On | 3 Blade | Red | Lit in ON Position |



Rocker Switch Bezel and Mounting Accessories

Snap-in mounting of any regular size switch such as 56027, 58030, 58332, 58311, 58312 or 58328 series.

- Bezels can be arranged in a parallel array of any length. Bezels themselves can snap into a panel, or be mounted with the bracket mounting kit.
- Mounting hole in panel should be 2.02"W x 1.90"H (51.3 x 48.3mm) for two bezels. Add 1.03"W (26.2mm) for each additional unit.

Additional information: littelfuse.com/RockerSwitches



82159-1

82159-2

82159-3

98628

82159-02-BP

87167-01-BP

Assembled Example

| PART NUMBERS | | | DETAILS | NOTES | DIMENSIONS |
|--------------|------------|------------------|--------------------------------------|---|--|
| BULK | BOXED | RETAIL CLAMSHELL | | | |
| 82159-1 | 82159-1-BX | 82159-1-BP | End Bezel | Can be used as left or right end | Two units are 2.37"W x 2.30"H (60.2 x 58.4mm) |
| 82159-2 | 82159-2-BX | – | Center Bezel | Can be ganged and used with end bezels | Two units are 2.37"W x 2.30"H (60.2 x 58.4mm) |
| 82159-3 | 82159-3-BX | – | Independent Bezel | Fits Panel Openings: 1.90" x 0.984" (48.3 x 25.0mm) | – |
| 98628 | 98628-BX | – | Bezel Panel Plug | Fits Panel Hole: .83" x 1.45" (21.1 x 36.8mm) | Face Dimensions: 1.91" x 0.96" (24.4 x 48.8mm) |
| – | – | 82159-02-BP | 2 End Bezels, 1 Center Bezel, 1 Plug | Bezel Retail Kit | – |
| – | – | 87167-01-BP | 2 Brackets, 1 Brass Stabilizing Rod | Bracket Mounting Retail Kit (holds 2 to 6 bezels) | Assembled kit mounts on top of or under the panel. Mounting holes .710" x .235" (18.0 x 6.7mm) |

Standard Heavy Duty Rocker Switches

25A Standard Heavy-Duty Rocker Switches with and without Pilot Lights

- Narrow or wide, moisture-resistant plastic, nickel plate or black housings, bezels and actuators
- Snap-in mounting to fit panels
- Brass blade or screw terminals

2D Prints and additional information: littelfuse.com/RockerSwitches



Metal Body Part Numbers



56000-01



56300-01



57000-01



57000-04



57000-10

| PART NUMBERS | | RATING | POLE & THROW | ACTION | TERMINALS | WIDTH | COLOR | ACTUATOR | PILOT LIGHT | CONTACTS |
|--------------|-------------|---------------|--------------|-------------|-----------|--------|---------------|----------|-------------|----------|
| BULK | BOXED | | | | | | | | | |
| 56000-01 | - | 25A at 12V DC | SPST | On-Off | 2 Screw | Narrow | Nickel Plated | White | | Silver |
| 56000-04 | 56000-04-BX | | SPST | On-Off | 2 Screw | Narrow | Nickel Plated | Black | | Silver |
| 56300-01 | 56300-01-BX | | SPST | On-Off | 3 Screw | Narrow | Nickel Plated | White | • | Silver |
| 57000-01 | 57000-01-BX | | SPST | On-Off | 2 Blade | Narrow | Nickel Plated | White | | Silver |
| 57000-04 | - | | SPST | On-Off | 2 Blade | Narrow | Black | Black | | Silver |
| 57000-10 | - | | SPST | On-Off | 2 Blade | Narrow | Black | Black | | Silver |
| 57003-01 | 57003-01-BX | | SPDT | On-Off-On | 3 Blade | Narrow | Nickel Plated | White | | Silver |
| 57004-10 | 57004-10-BX | | SPDT | Mom-Off-Mom | 3 Blade | Narrow | Black | White | | Silver |
| 57006-01 | - | | DPDT | On-Off-On | 6 Blade | Narrow | Nickel Plated | White | | Silver |
| 57006-07 | 57006-07-BX | | DPDT | On-Off-On | 6 Blade | Narrow | Black | White | | Silver |
| 57007-11 | - | | SPDT | On-On-Off | 3 Blade | Narrow | Black | Black | | Silver |
| 57014-03 | 57014-03-BX | | DPDT | Mom-Off-Mom | 4 Blade | Narrow | Black | White | | Silver |
| 57300-01 | 57300-01-BX | | SPST | On-Off | 3 Blade | Narrow | Nickel Plated | White | • | Silver |
| 57300-22 | 57300-22-BX | | SPST | On-Off | 3 Blade | Narrow | Black | White | | Silver |
| 57300-11 | 57300-11-BX | | SPST | On-Off-On | 4 Blade | Narrow | Black | White | • | Silver |
| 57300-03 | 57300-03-BX | | SPST | On-Off | 3 Blade | Narrow | Nickel Plated | Black | • | Silver |
| 57300-02 | - | | SPST | On-Off | 3 Blade | Wide | Nickel Plated | White | • | Silver |

Plastic Body Part Numbers



57000-08



57000-23

| PART NUMBERS | | RATING | POLE & THROW | ACTION | TERMINALS | ACTUATOR | CONTACTS |
|--------------|-------------|---------------|--------------|-------------------|-----------|----------|----------|
| BULK | BOXED | | | | | | |
| 56000-08 | - | 25A at 12V DC | SPST | On-Off | 2 Screw | White | Silver |
| 57000-23 | 57000-23-BX | 25A at 12V DC | SPST | On-Off | 2 Blade | White | Silver |
| 57013-08 | 57013-08-BX | 25A at 12V DC | DPDT | Mom On-Off-Mom On | 6 Blade | White | Silver |

FAQ's Rocker & Toggle Switches

Can I replace the bulb in any of your Toggle or Rocker Switches?

The bulbs are wired inside the Switch and therefore cannot be replaced. We use a long lasting bulb so the need for bulb replacement is unlikely in a normal automotive application. We also have LED switches such as 58312 Series that never need replacement. 58312 Series can be found on page 80.

Can I use your Non-Lighted Toggle or Rocker Switches in 110V AC applications?

Except for Switches M-493, 5507 and similar Switches, none of our Switches are officially rated for AC voltage application. While we are confident some of them can, it is entirely up to the end user to determine their suitability for such application. M-493 and 5507 can be found on page 90.

Can I use your Lighted Rocker and Toggle Switches at 110V AC?

No. The lamps inside the Switches have specific voltage ratings.

Can I use your Lighted Rocker and Toggle Switches at 24V DC?

You need to select only the ones rated for 24V because the lights function only at the designed voltage.

Can I use your Non-Lighted Toggle and Rocker switches at 24V DC?

Yes. If they are rated at 12V, you must reduce the current rating by half to obtain the same durability.

Can I get any of your Toggle or Rocker Switches modified to meet my special application?

Yes, in most cases. It is possible we make a suitable item already that isn't listed because of its specialized use. Alternatively, we can make it for you. We have a minimum quantity requirement for special orders.

Do your Lighted Toggle or Rocker Switches have incandescent or LED lamps?

We have both. Contact us if you need a special order with LEDs.

Can I have my company's imprinting placed on a rocker switch?

Yes. Contact us. If it's a standard legend or SAE symbol, there's a chance that it's already available.



5507



54007



58312-A2 & A4



58312-R2 & R4



M-58031-01

Toggle Switches



Dependent or Independent Illumination?

Dependent:

The actuator is illuminated only when the switch is turned on.

Independent:

Illumination is not affected by the actuation of the switch. The illumination can be switched on or off by another switch, such as headlight or interior lighting controls. This is especially useful when locating switches in the dark.



What Does SPST or DPST Mean?

The first two letters, SP or DP, refer to single pole or double pole. The second two letters, ST or DT refer to single throw or double throw.

Pole refers to the number of circuits controlled by the switch. SP switches control one circuit and DP switches control two independent circuits (which act like two identical switches that are mechanically linked). Pole is often confused with terminal, which is a common mistake. Terminals are used for wire connections on the back of the unit and are specified separately.

Throw refers to the extreme position of the actuator. ST switches close a circuit at only one position and the other position is off. DT switches close a circuit in the Up position, as well as the down position and can be configured with two positions (On-Off) or three positions (On-Off-On).

12V, 24V, 36V Ratings

Generally, our 12V non-illuminated toggle switches can be used at higher voltages (and lower current ratings). By proportional calculation a 25A 12V can be used at 8.3A at 36V or 12.5A at 24V. This 'de-rating' actually gives a conservative result. 25A at 12V toggles can actually be used at 15A at 24V and 10A at 36V.

Warning: Switches with pilot lights must be used only at the stated voltage, since the lighting elements function at a specific voltage.



55025 Series • 25A Sealed Toggle



- Waterproof and dustproof to IP68 standard – allows mounting in demanding or harsh locations
- Bushing, handle and hardware – nickel-plated brass
- Standard handle, 0.60" long (15.3mm)
- Standard mounting panel hole 0.468 – 0.474" diameter (11.9-12.0mm)
- Standard bushing diameter 0.47 (12.0mm) 15/32" thread, 0.32" long (5.8mm)
- Wires: 14AWG (2mm²), 12" long (304.8mm)
- Switch body: 1.24" deep x 0.87" wide x 1.46" high (31.6 x 22.0 x 37.1mm)

2D Prints and additional information: littelfuse.com/55025

| PART NUMBERS | | | RATING | POLE & THROW | ACTUATOR | ACTION | TERMINALS | CONTACTS | SEALING |
|--------------|-------------|------------------|---------------|--------------|----------------------------|-------------------|-----------|----------|---------|
| BULK | BOXED | RETAIL CLAMSHELL | | | | | | | |
| 55025 | 55025-BX | 55025-BP | 25A at 12V DC | SPST | Nickel-plated brass handle | On-Off | 2 wire | Silver | IP68 |
| 55025-01 | 55025-01-BX | 55025-01-BP | | SPST | | Mom On-Off | 2 wire | | IP68 |
| 55025-02 | 55025-02-BX | 55025-02-BP | 15A at 24V DC | SPDT | Nickel-plated brass handle | On-Off-On | 3 wire | Silver | IP68 |
| 55025-03 | 55025-03-BX | 55025-03-BP | | SPDT | | On-On | 3 wire | | IP68 |
| 55025-04 | 55025-04-BX | 55025-04-BP | | SPDT | | Mom On-Off-Mom On | 3 wire | | IP68 |



Standard Switch



Illuminated Switch

54100 Series • 25A Standard or Illuminated Toggle Switches

Available in a standard black nylon handle or a lighted clear plastic handle, that is 1 1/16" (17.5mm) long.

- Mounting stem 15/32"-32 thread, 15/32" (11.9mm) long, fits panels up to 1/8" (31.8mm) thick
- Includes mounting hardware: black metal facenut and nickel-plated hexnut
- Terminals: .250" blade or 6-32 screw

2D Prints and additional information: littelfuse.com/54100



| PART NUMBERS | | | RATING | POLE & THROW | ACTUATOR | ACTION | ILLUMINATION | ILLUMINATION COLOR | | | TERMINALS | CONTACTS | SEALING |
|--------------|-------------|------------------|---------------|--------------|----------------------|-------------------|--------------------------|--------------------|--------|-----|-----------|----------|-------------------|
| BULK | BOXED | RETAIL CLAMSHELL | | | | | | DOWN | CENTER | UP | | | |
| 54100 | 54100-BX | 54100-BP | 25A at 12V DC | SPST | Black Plastic Paddle | On-Off | - | - | - | - | 2 screw | Silver | - |
| 54100-01 | - | 54100-01-BP | | SPST | Black Plastic Paddle | On-Off | - | - | - | - | 2 blade | | O-ring in bushing |
| 54101-01 | - | - | | SPST | Black Plastic Paddle | Mom On-Off | - | - | - | - | 2 blade | | - |
| 54109 | 54109-BX | 54109-BP | | SPST | Clear Plastic Paddle | On-Off | Independent or Dependent | White | - | Red | 4 screw | | O-ring in bushing |
| 54109-01 | 54109-01-BX | - | | SPST | Black Plastic Paddle | On-Off | Independent or Dependent | White | - | Red | 4 blade | | O-ring in bushing |
| 54103 | - | 54103-BP | | SPDT | Black Plastic Paddle | On-Off-On | - | - | - | - | 3 screw | | - |
| 54104 | 54104-BX | 54104-BP | | SPDT | Black Plastic Paddle | Mom On-Off-Mom On | - | - | - | - | 3 screw | | - |
| 54110 | - | - | | SPDT | Clear Plastic Paddle | On-Off-On | Independent or Dependent | White | White | Red | 4 screw | | O-ring in bushing |
| 54107-01 | - | 54107-01-BP | | DPDT | Black Plastic Paddle | On-Off-On | - | - | - | - | 6 screw | | - |

Toggle Switches

25A Heavy Duty Toggle Switches

Standard or long handle. Universal application. Mounting stem is nickel-plated brass 15/32"-32 thread, 15/32" (11.9mm) long, and fits panels up to 9/32" (7.1mm) except where stated otherwise. Phenolic housing, with plated steel cap.

2D Prints and additional information: littelfuse.com/ToggleSwitches



Standard handle, 11/16" (17.5mm) long.



Long handle, 1 1/2" (38.1mm) long.



PVC coated housing with wire leads.

| PART NUMBERS | | | RATING | POLE & THROW | ACTUATOR LENGTH | MATERIAL | ACTION | TERMINALS | CONTACTS | PVC COATED | O-RING SEAL |
|--------------|-------------|-------------|---------------------------------|--------------|-------------------|------------------------|-------------------|----------------|----------|------------|-------------|
| BULK | BOXED | RETAIL | | | | | | | | | |
| 5520 | 5520-BX | 5520-BP | 25A at 12V DC, 15A at 24V DC | SPST | Standard | Nickel-Plated Brass | On-Off | 2 screw | Silver | | • |
| 5582 | 5582-BX | 5582-BP | | SPST | Standard | | On-Off | 2 screw | | | |
| - | - | 5582-30-BP | | SPST | Standard | | On-Off | 2 wire | | | |
| 5582-36 | - | - | | SPST | Standard | | On-Off | Aptiv 12010973 | | | |
| 5582-10 | 5582-10-BX | - | | SPST | Standard | | On-Off | 2 wire | | | • |
| 55014 | 55014-BX | 55014-BP | | SPST | Standard | | On-Off | 2 blade | | | • |
| 55014-05 | 55014-05-BX | - | | SPST | Standard | | On-Off | 2 blade | | | • |
| 55016-06 | - | 55016-06-BP | | SPDT | Standard | | On-Off-On | 3 blade | | | |
| 55023 | 55023-BX | - | | SPST | Standard | | On-Off | 2 screw | | | |
| 55055 | 55055-BX | 55055-BP | | SPST | Long | | On-Off | 2 blade | | | |
| 55020 | 55020-BX | 55020-BP | | SPST | Standard | | Off-Mom On | 2 screw | | | |
| 55020-02 | - | 55020-20-BP | | SPST | Standard | | Off-Mom On | 2 blade | | | |
| 55020-04 | 55020-04-BX | 55020-04-BP | | SPST | Standard | | Off-Mom On | 2 wire | | • | • |
| 5584 | 5584-BX | - | | SPDT | Standard | | On-On | 3 screw | | | |
| 5584-15 | - | - | | SPDT | Standard | | On-On | 3 wire | | | |
| 5586 | 5586-BX | 5586-BP | | SPDT | Standard | | On-Off-On | 3 screw | | | |
| 55015 | 55015-BX | - | | SPDT | Standard | | On-On | 3 blade | | | |
| 55016 | 55016-BX | - | | SPDT | Standard | | On-Off-On | 3 blade | | | |
| 55036 | 55036-BX | - | | SPDT | Standard | | On-Off-On | 3 wire | | • | • |
| 55021 | 55021-BX | 55021-BP | | SPDT | Standard | | Mom On-Off-Mom On | 3 screw | | | |
| 55021-04 | 55021-04-BX | 55021-04-BP | | SPDT | Standard | | Mom On-Off-Mom On | 3 blade | | | |
| 55021-07 | 55021-07-BX | 55021-07-BP | | SPDT | Standard | | Mom On-Off-Mom On | 3 wire | | • | • |
| 55033-01 | 55033-01-BX | - | | SPDT | Standard | | Mom On-Off-Mom On | 3 blade | | | |
| 55033-02 | 55033-02-BX | - | | SPDT | Long | | Mom On-Off-Mom On | 3 blade | | | |
| 55088 | 55088-BX | 55088-BP | | SPDT | Standard | | On-Off-Mom On | 3 screw | | | |
| 5588 | 5588-BX | 5588-BP | | DPST | Standard | | On-Off | 4 screw | | | |
| 55017 | 55017-BX | - | | DPST | Standard | | On-Off | 4 blade | | | |
| 55017-02 | 55017-02-BX | - | | DPST | Long | | On-Off | 4 blade | | | |
| 5590 | 5590-BX | - | | DPDT | Standard | | On-On | 6 screw | | | |
| 5592 | 5592-BX | 5592-BP | | DPDT | Standard | | On-Off-On | 6 screw | | | |
| 55018 | 55018-BX | - | | DPDT | Standard | | On-On | 6 blade | | | |
| 55019 | 55019-BX | 55019-BP | | DPDT | Standard | | On-Off-On | 6 blade | | | |
| 55054 | 55054-BX | 55054-BP | DPDT | Standard | Mom On-Off-Mom On | 6 screw | | | | | |
| 55054-04 | 55054-04-BX | - | DPDT | Long | Mom On-Off-Mom On | 6 screw | | | | | |
| 55065-02 | 55065-02-BX | - | DPDT | Long | Mom On-Off-Mom On | 6 blade | | | | | |
| 55065-03 | 55065-03-BX | - | DPDT | Standard | Mom On-Off-Mom On | 6 blade | | | | | |
| 55046 | 55046-BX | - | DPDT | Standard | Mom On-Off-Mom On | 4 blade | | | | | |
| 55046-04 | 55046-04-BX | - | DPDT | Long | Mom On-Off-Mom On | 4 blade | | | | | |
| 55049-01 | 55049-01-BX | - | SPST | Long | On-Mon-Off | 2 blade | | | | | |
| - | 55107-01-BX | - | SPDT | Standard | On-On | 9 blade | | | | | |

* Please inquire about additional bulk quantities



5507 - Ball Handle



5558 - Standard Handle

10A Light Duty Toggle Switches

- Standard handle: 11/16" (17.46mm) long
- Ball handle: 3/8" (9.52mm) long
- Mounting stem has 15/32"-32 thread, 15/32" (11.9mm) long, and fits panels up to 9/32" (7.2mm) thick

2D Prints and additional information: littelfuse.com/ToggleSwitches

| PART NUMBERS | | | RATING | POLE & THROW | ACTUATOR | | ACTION | TERMINALS | CONTACTS |
|--------------|----------|----------|---------------|--------------|----------|---------------------|--------|------------------|----------|
| BULK | BOXED | RETAIL | | | TYPE | MATERIAL | | | |
| 5507 | 5507-BX | — | 10A at 12V DC | SPST | Ball | Nickel-Plated Brass | Off-On | 2 screw | Silver |
| 5558 | 5558-BX | 5558-BP | 10A at 12V DC | SPST | Standard | Nickel-Plated Brass | Off-On | 2 screw | Silver |
| 5568 | 5568-BX | — | 10A at 12V DC | SPST | Ball | Nickel-Plated Brass | Off-On | 2x 6" wire leads | Silver |
| 5570 | 5570-BX | — | 10A at 12V DC | SPST | Standard | Nickel-Plated Brass | Off-On | 2x 6" wire leads | Silver |
| 55013 | 55013-BX | — | 10A at 12V DC | SPST | Standard | Nickel-Plated Brass | Off-On | 2 blade | Silver |
| M-484 | M-484-BX | M-484-BP | 10A at 12V DC | SPST | Standard | Chrome-Plated Brass | Off-On | 2 screw | Silver |
| M-493 | — | M-493-BP | 10A at 12V DC | SPST | Ball | Chrome-Plated Brass | Off-On | 2 screw | Silver |
| M-584 | M-584-BX | M-584-BP | 10A at 12V DC | SPST | Standard | Chrome-Plated Brass | Off-On | 2x 6" wire leads | Silver |

551800 Series • 30A Extra Heavy Duty Toggle Switches

Universal application. Diecast housing. For stem- or bracket-mounting. 15/32"-32 thread mounting stem, with keyway.

- Brackets: .170" (4.3mm) diameter holes, 1.72" (43.7mm) on centers
- Fits panels up to 3/16" (4.8mm) thick
- Chrome plated brass handle, 1 1/16" long (27.0mm)

2D Prints and additional information: littelfuse.com/ToggleSwitches



| PART NUMBERS | | | RATING | POLE & THROW | ACTION | ACTUATOR | TERMINALS | CONTACTS |
|--------------|-----------|-----------|-------------------------------------|--------------|-------------------|----------------------------|-----------|----------|
| BULK | BOXED | RETAIL | | | | | | |
| — | 551001-BX | — | 20A at 6-12V DC | SPST | Mom On-Off | Chrome-plated brass handle | 2 blade | Silver |
| — | 551800-BX | — | | SPST | On-Off | | 2 screw | |
| 551802 | — | — | | SPDT | On-Off-On | | 3 screw | |
| 551840 | 551840-BX | 551840-BP | 30A at 6-12V DC 15A at 24-36V DC | SPST | On-Off | | 2 screw | |
| 551841 | 551841-BX | — | | SPST | Mom On-Off | | 2 screw | |
| 551842 | 551842-BX | — | | SPDT | On-Off-On | | 3 screw | |
| 551844 | 551844-BX | — | | SPDT | Mom On-Off-Mom On | | 3 screw | |
| — | 551846-BX | — | | DPDT | On-Off-On | | 6 screw | |
| 551849 | — | — | | SP3C | On-On-Off | | 4 screw | |

M-54111 Series • 25A Lighted Tip Toggles

Tip of handle is illuminated Red in the On position, illuminated Clear in the Off position.

2D Prints and additional information: littelfuse.com/ToggleSwitches

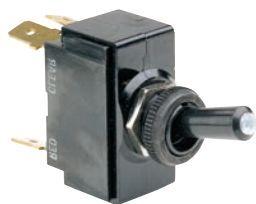

| PART NUMBERS | | | RATING | POLE & THROW | ACTION | ACTUATOR | ILLUMINATION | ILLUMINATION COLOR | | TERMINALS | CONTACTS |
|--------------|---------------|------------------|---------------|--------------|-----------|---|--------------------------|--------------------|-------|-----------|----------|
| BULK | BOXED | RETAIL CLAMSHELL | | | | | | ON | OFF | | |
| M-54111-01 | M-54111-01-BX | M-54111-01-BP | 25A at 12V DC | SPST | On-Off | Black plastic handle w/ illuminated tip | Independent or Dependent | Red | White | 4 blade | Silver |
| M-54111-02 | M-54111-02-BX | M-54111-02-BP | 25A at 12V DC | SPDT | On-Off-On | Black plastic handle w/ illuminated tip | Independent or Dependent | Red | White | 5 blade | Silver |

Toggle Switches



59024 Series • 25A Long Handle "Duck Bill" Toggle Switches

- 15/32"-32 thread mounting stem
- Fits panels up to 1/4" (6.4mm) thick
- Includes mounting hardware: black knurled facenut, hexnut
- Keyway is in the down position. 1" (25.4mm) handle, black plastic, matte finish
- Terminals: .250" blade or 8-32 screw

2D Prints and additional information: littelfuse.com/ToggleSwitches

| PART NUMBERS | | | RATING | POLE & THROW | ACTION | ACTUATOR | TERMINALS | CONTACTS | SEALING |
|--------------|--------------|------------------|---------------|--------------|-------------------|--------------------------------|-----------|----------|---------|
| BULK | BOXED | RETAIL CLAMSHELL | | | | | | | |
| 59024-100 | 59024-100-BX | – | 25A at 12V DC | SPST | On-Off | Black Plastic Duck Bill Paddle | 2 blade | Silver | – |
| 59024-104 | – | – | | SPDT | On-On | | 3 blade | | – |
| 59024-106 | 59024-106-BX | – | | SPDT | On-Off-On | | 3 blade | | – |
| – | 59024-108-BX | – | | SPDT | Mom On-Off-Mom On | | 3 blade | | – |
| 59024-110 | 59024-110-BX | – | | DPST | On-Off | | 4 blade | | – |
| 59024-116 | – | – | | DPDT | On-On | | 6 blade | | – |
| 59024-118 | – | – | | DPDT | On-Off-On | | 6 blade | | – |
| 59024-200 | 59024-200-BX | – | | SPST | On-Off | | 2 screw | | – |
| 59024-218 | – | – | | DPDT | On-Off-On | | 6 screw | | – |



59024-00 Series • Freightliner Replacement "Duck Bill" Toggle Switches

Black phenolic switch housing with metal cap. Terminals are arranged to match OEM wiring connectors with or without brackets.

- Fits panels to .093" (2.4mm) with spacer provided, or to .25" (6.4mm) without spacer
- 15/32"-32 thread mounting stem
- Includes mounting hardware: black metal facenut. Keyway is in the down position
- Black plastic 1" (25.4mm) handle, matte finish
- Dual contacts for extra durability

2D Prints and additional information: littelfuse.com/ToggleSwitches

| PART NUMBERS | | | RATING | POLE & THROW | ACTION | ACTUATOR | TERMINALS | CONTACTS | DUAL CONTACTS | MOUNTING BRACKET |
|--------------|-------------|------------------|---------------|--------------|------------------|--------------------------------|-----------|----------|---------------|------------------|
| BULK | BOXED | RETAIL CLAMSHELL | | | | | | | | |
| 59024-33 | 59024-33-BX | – | 25A at 12V DC | SPST | On-Off | Black Plastic Duck Bill Paddle | 2 blade | Silver | • | • |
| 59024-35 | 59024-35-BX | – | | DPST | On-Off | | 4 blade | | • | • |
| 59024-36 | 59024-36-BX | – | | DPDT | On-Off-On | | 6 blade | | • | • |
| 59024-38 | 59024-38-BX | – | | DPDT | Mom On-On-Mom On | | 6 blade | | • | • |
| 59024-12 | 59024-12-BX | – | | SPST | On-Off | | 2 blade | | • | • |
| 59024-14 | 59024-14-BX | – | | DPST | On-Off | | 4 blade | | • | • |
| 59024-15 | 59024-15-BX | – | | DPDT | On-Off-On | | 6 blade | | • | • |

Toggle Switches & Accessories



Specialized Application Toggle Switches

- Specialized toggle switches have specific functions and applications. See the "APPLICATION NOTES" column below for details
 - 15/32"-32 thread mounting stem, .46" (11.9mm) long, mounts in panels up to 9/32" (7.1mm) thick
 - Nickel-plated brass handle: standard .687" (17.5mm) or long 1.5" (38.1mm)
- 2D Prints and additional information: littelfuse.com/ToggleSwitches

| PART NUMBERS | | RATING | POLE & THROW | ACTION | | | ACTUATOR | | TERMINALS | CONTACTS | APPLICATION NOTES |
|--------------|-------------|---------------|-------------------|-------------------------------|--------|------------------------------|---------------|---------------------|-----------|----------|---|
| BULK | BOXED/BP | | | UP | CENTER | DOWN | HANDLE LENGTH | MATERIAL | | | |
| 55064 | 55064-BX | 25A at 12V DC | DPDT 4-circuit | Park, Tail & Headlamps | Off | Park, Tail & Auxiliary Lamps | Long | Nickel-Plated Brass | 6 blade | Silver | 4-Circuit Headlamp Switch |
| 55071 | - | 25A at 12V DC | DP 2-circuit | Mom On B, 1&2 (Day Signaling) | On 1&2 | Mom Off (Night Signaling) | Standard | Nickel-Plated Brass | 3 blade | Silver | 2-Circuit Marker Lamp Switch |
| 55015-03 | 55015-03-BX | 25A at 12V DC | SPDT | On | - | On | Standard | Nickel-Plated Brass | 3 blade | Silver | 3-way Lighting Switch See Diagrams Below |
| 59071 | 59071-BX | 25A at 12V DC | DP | Mom On 1, 4&5 | On 4&5 | Off | Standard | White Plastic | 3 blade | Silver | Ignition/Start |
| 55093 | 55093-BX | | SPDT | On | On | Off | Standard | Nickel-Plated Brass | 3 blade | Silver | Two Speed Heater Fan Toggle Switch |
| M-597 | M-597-BP | | SPST | On | - | Mom On | Standard | Nickel-Plated Brass | 3 Leads | Silver | Marine Safety Switch |

3- and 4-way Lighting

3-way lighting permits a light (or a set of lights) to be controlled from two switches usually mounted in different locations. Similarly, 4-way lighting enables control from three switch locations.



Toggle Accessories



| PART NUMBERS | | | DESCRIPTION |
|--------------|-------------|-------------|--|
| BULK | BOXED | RETAIL | |
| 82468 | 82468-BX | - | Flip Cover Switch Guard |
| 5543 | 5543-BX | - | 5558 switch mounted in 5543-15 Recessed Faceplate Switch Guard |
| 5543-15 | 5543-15-BX | - | Recessed Faceplate Switch Guard |
| 81255 | 81255-BX | 81255-BP | Half-Boot Seal |
| 81264 | 81264-BX | 81264-BP | Grey Boot Seal (other colors available, please contact Littelfuse) |
| 81264-01 | 81264-01-BX | 81264-01-BP | Black Boot Seal (other colors available, please contact Littelfuse) |
| 81264-05 | 81264-05-BX | - | Red Boot Seal (other colors available, please contact Littelfuse) |
| 5543-09 | - | - | 55015-12 switch mounted Recessed Faceplate Switch Guard |
| 81264-02 | 81264-02-BX | - | Blue Boot Seal (other colors available, please contact Littelfuse) |
| 81264-07 | 81264-07-BX | - | Yellow Boot Seal (other colors available, please contact Littelfuse) |
| 8250 | 8250-BX | - | Toggle Switch "ON - OFF" Face Plate Cover |
| M-598 | - | M-598-BP | Toggle Marine Emergency Lanyard |

* Please inquire about additional bulk quantities

Switch Diagrams

Switch Reference Guide - SPST, SPDT, DPST, DPDT

SP and DP refer to single pole and double pole, ST and DT refer to single throw and Double throw.

SP: Single Pole, one circuit controlled by the switch.

DP: Double Pole, two independent circuits controlled by the switch which are mechanically linked.

Note: "Pole" should not be confused with "Terminal". The DPST switch, for example has four terminals however it is a Double Pole (DP) and not a four pole (4P) switch.

ST: Single Throw, closes a circuit at only one position and with one throw.

DT: Double Throw, closes a circuit in the up or down position (On-On). A Double Throw switch can also have a center position such as On-Off-On.

The following switch diagrams illustrate the most common types of toggle and rocker switch.

SPST On-Off



DPST On-Off

Both load terminals can be energized at the same time. They are independent of each other and could be of different voltages.



SPDT On-On

Only one of the loads can be energized at a time.

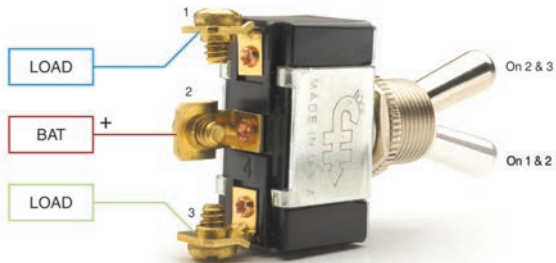

DPDT On-On

Functions like two separate SPDT switches operated by the same actuator. Only two loads can be On at a time.

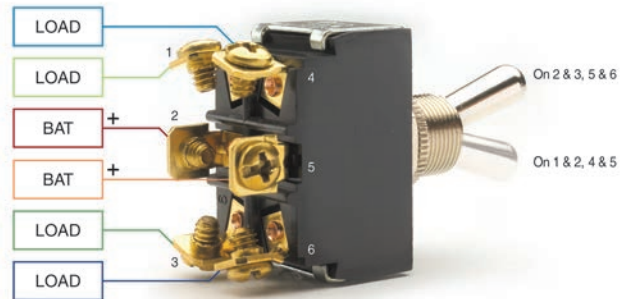

SPDT On-Off-On

Only one of the loads can be energized at a time.

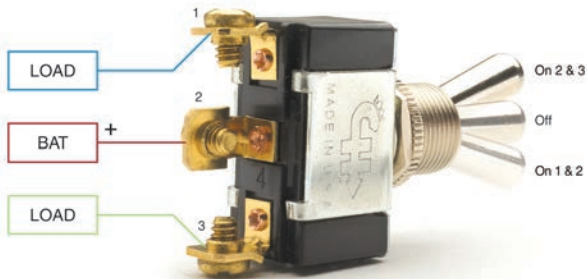

DPDT On-Off-On

Functions like two separate SPDT switches operated by the same actuator. Only two loads can be On at a time.



Switch Diagrams

Single-Pole (SP) & Double-Pole (DP) Switch Wiring Diagrams

Diagrams represent both momentary contact or maintained contact switches.

Switches without Pilot Lights

SPST Off-ON (2 terminals)

Diagram A



Diagram A1



SPDT On-Off-On (3 terminals)

Diagram B



-

-

DPST Off-On (4 terminals)

Diagram C



Diagram C1



DPDT On-On (6 terminals)

Diagram D



-

-

DPDT On-Off-On (6 terminals)

Diagram E



-

-

Switches with One Pilot Light

SPST Off-ON – Dependent Illumination (Three terminals)

Diagram F



SPST Off-ON – Independent Illumination (Four terminals)

Diagram G1



SPST Off-ON – Independent converted to Dependent (4 terminals)
Connect jumper wire from T3 to T6 and connect T4 to ground

Diagram G2

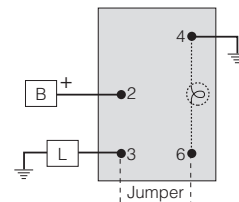

Switches with Two Pilot Lights

SPST Off-On with Dependent & Independent Lights (Four terminals)

Diagram H



SPDT On-Off-On or On-On with Dependent & Independent Lights (Four terminals)

Diagram J



SPDT On-Off-On or On-On with 2 Independent Lights (Four terminals)

Diagram K



Momentary Switches



Momentary switches operate by pushing a button either by thumb or by the closing of a door and will remain in their switched state as long as they are being actuated. Momentary Switches are either “normally Off, spring return to Off” or “normally On, spring return to On.”

What Does Momentary Mean?

A momentary switch, also known as a “mom,” is spring-loaded. When pressed the actuator moves, remove your finger and it returns to its original position. Opposite of a momentary switch is a maintained contact switch. When the actuator is pressed it stays in the position until it is pressed in the other direction.

More Momentary Switches in Other Sections

Find more momentary switches (moms) in the following catalog sections.

- Ignition Switches
- Rocker Switches
- Toggle Switches
- Push-Pull Switches
- Rotary Switches
- Foot Operated Switches



Momentary Push-Button Switches

35A • Heavy Duty Cylindrical Housing Push-Button Switches

For applications to 36V DC. On with button depressed, spring return to Off.

Additional information: littelfuse.com/Push-Button-Switches



| PART NUMBERS | | | RATING | POLE & THROW | NORMAL POSITION | ACTUATOR | | TERMINALS | CONTACTS | MOUNTING STEM | NOTES |
|--------------|-------------|------------------|--------------------------------|--------------|-----------------|----------------------------------|--|-------------------------------|----------|-----------------------------------|--|
| BULK | BOXED | RETAIL CLAMSHELL | | | | DETAIL | CAP | | | | |
| 9095 | 9095-BX | - | 35A at 12V DC 20A at 24V DC | SPST | Normally Off | Chrome Plated Button | - | 2 Screw | Silver | 5/8"-32 thread 21/32" long | - |
| 9245 | 9245-BX | 9245-BP | | | Normally Off | Black Plastic Button | Snap-On Black Rubber | 2 Screw | | 5/8"-32 thread 21/32" long | O-ring Seal |
| - | 90036-02-BX | - | | | Normally Off | Chrome Plated Button | - | 2 Blade | | 5/8"-32 thread 21/32" long | Fits Delphi (Packard) 2-way Connector 2973407 |
| 9231 | 9231-BX | - | | | Normally Off | Recessed Chrome Plated Button | - | 2 Screw | | 5/8"-32 thread 21/32" long | Protected Button with Recessed Design |
| 90030 | 90030-BX | 90030-BP | | | Normally Off | Black Plastic Button | Screw-On Black Rubber | 2 Screw | | 5/8"-32 thread 21/32" long | - |
| 90030-01 | 90030-01-BX | - | | | Normally Off | Black Plastic Button | Screw-On Brown Oil-Resistant Rubber | 2 Screw | | 5/8"-32 thread 21/32" long | - |
| 90030-04 | 90030-04-BX | - | | | Normally Off | Black Plastic Button | Screw-On Red Rubber | 2 Screw | | 5/8"-32 thread 21/32" long | - |
| 90030-12 | - | - | | | Normally Off | Chrome Plated Button | Black Cap | 2 Terminal Wire | | 5/8"-32 thread 5/8" long | - |
| 90030-24 | - | - | | | Normally Off | Chrome Plated Button | Black Cap | 2 Screw | | 5/8"-32 thread 5/8" long | - |
| 90030-33 | - | - | | | Normally Off | Chrome Plated Button | Black "Push" Cap | 2 Screw | | 5/8"-32 thread 5/8" long | - |
| 90030-43 | - | - | | | Normally Off | Chrome Plated Button | Black Cap | 2 Screw | | 5/8"-32 thread 5/8" long | - |
| 90030-53 | - | - | | | Normally Off | Chrome Plated Button | Black Cap | 2 Screw | | 5/8"-32 thread 5/8" long | Assembled |
| 90036-10 | - | - | | | Normally Off | Chrome Plated Button | Black Cap | 2 Blade | | 5/8"-32 thread 5/8" long | Horn Imprinted |
| 9216-03 | 9216-03-BX | - | | | Normally Off | Chrome Plated Button | Screw-On Black Rubber | 2 Screw | | 5/8"-32 thread 5/8" long | Gold Dichromate Dipped Case |
| 9100 | 9100-BX | - | | | Normally Off | Chrome Plated Plunger | - | 2 Screw | | 15/32"-32 thread 9/16" long | - |
| 9216-10 | - | - | | | Normally Off | Chrome Plated Button | Black Cap | Aptiv 12010973 (Sealed) | | 5/8"-32 thread 5/8" long | Sealed Gold Dichromate Dipped Case |
| 9216 | 9216-BX | - | | | Normally Off | Chrome Plated Button | - | 2 Screw | | 5/8"-32 thread 5/8" long | Sealed Gold Dichromate Dipped Case |
| 9276-09 | 9276-09-BX | - | | | Normally Off | Black Plastic Button | Screw-On Black Rubber | 2 Screw | | 5/8"-32 thread 21/32" long | Two circuits simultaneously energized |
| 9238-07 | - | - | | | Normally Off | Chrome Plated Button | - | 2 Blade | | 5/8"-32 thread 7/8" long | - |
| 90018 | - | - | | | Normally Off | Chrome Plated Button | - | 2 Screw | | 5/8"-32 thread 5/8" long | - |

10

Momentary Push-Button Switches

10A • Heavy Duty Rectangular Housing Push-Button Switches

For applications up to 36V DC. On with button depressed, spring return to Off.

Additional information: littelfuse.com/Push-Button-Switches



| PART NUMBERS | | RATING | POLE & THROW | ACTION | NORMAL POSITION | ACTUATOR | | TERMINALS | MOUNTING STEM | NOTES |
|--------------|----------|--|--------------|------------|-----------------|--|-----------|-----------|----------------------------|--|
| BULK | BOXED | | | | | DETAIL | CAP | | | |
| - | 9044-BX | 10A at 12V DC | SPST | Off-On | Off | Chrome Plated Button | - | 2 Screw | 5/8"-32 thread 1.06" long | Gasket Seal |
| 9023 | 9023-BX | 15A Resistive, 10A Inductive at 12V DC 8A Resistive, 5A Inductive at 24V DC | SPST | Off-On | Off | Chrome Plated Button | - | 2 Screw | 5/8"-32 thread .87" long | - |
| 9238 | 9238-BX | 15A Resistive, 10A Inductive at 12V DC 8A Resistive, 5A Inductive at 24V DC | SPST | Off-On | Off | Chrome Plated Button | - | 2 Blade | 5/8"-32 thread .87" long | - |
| 9115 | 9115-BX | 10A at 12V DC | SPST | On-Off | On | Chrome Plated Button | - | 2 Screw | 5/8"-32 thread 7/8" long | - |
| 9211 | 9211-BX | 10A at 12V DC | DPST | On-Off | On | White Plastic .33"Ø Button | - | 4 Blade | 7/16"-20 thread | Commonly used in school bus stepwell and door control |
| 9109 | 9109-BX | 10A at 12V DC | SPST | Off-On | Off | Shaft has 3/32" hole for cable or lever attachment | - | 2 Screw | 1/2"-20 thread 5/8" long | Pull On, Spring Return to Off |
| 9212 | 9212-BX | 10A at 12V DC | SPST | On-Off | On | 1/2" Plunger | Nylon Cap | 2 Blade | 7/16"-20 thread 1/2" long | Brass Contacts |
| 9165 | 9165-BX | 10A at 12V DC | DPST | Off-On | Off | Chrome Plated Button | - | 3 Screw | 5/8"-32 thread 21/32" long | 2 steel hexnuts and facenet on stem |
| 91126 | 91126-BX | 10A at 12V DC | SPST | Off-Mom On | Off | Chrome Plated Plunger | - | 2 Wire | 7/16"-20 thread 7/16" long | - |
| 92116 | 92116-BX | 10A at 12V DC | SPST | Off-On | Off | Chrome Plated Plunger | Black Cap | 2 Blade | 5/8"-32 thread 1" long | Hencol Sealed |
| 90002 | 90002-BX | 10A at 12V DC | SPST | On-Mom Off | On | Chrome Plated Button | - | 2 Screw | 5/8"-32 thread 1.25" long | - |
| 91109-03 | - | 20A at 12V DC 10A at 24V DC | DPST | On-On | On | Chrome Plated Button | Black Cap | 4 Wire | 5/8"-32 thread 3/4" long | Cir. A Normally On, Cir. A Off/ Cir. B On when depressed (spring return to A On). |

20A • Heavy Duty Rectangular Housing Push-Button Switches for Mechanical Activation

10A at 24V DC, 20A at 12V DC. On with button depressed, spring return to Off.

- Steel button protrudes through the cap. Black rubber cap snaps into a special groove on the nut, which is deep-threaded and gives a positive seal
- Steel button feature is ideal for mechanical actuation

Additional information: littelfuse.com/Push-Button-Switches



90043



90043-07

| PART NUMBERS | | | RATING | POLE & THROW | ACTION | NORMAL POSITION | ACTUATOR | | TERMINALS | MOUNTING STEM | GASKET SEAL | NOTES |
|--------------|-------------|------------------|--------------------------------|--------------|--------|-----------------|---------------|----------------------|------------------|---------------------------|-------------|--|
| BULK | BOXED | RETAIL CLAMSHELL | | | | | DETAIL | CAP | | | | |
| 90043 | 90043-BX | - | 20A at 12V DC 10A at 24V DC | SPST | Off-On | Off | Steel Plunger | Snap-On Black Rubber | 2 Blade | 5/8"-32 thread .625" long | • | Fits Delphi (Packard) 2-Pole Connector 2977647 |
| 90043-07 | 90043-07-BX | - | 20A at 12V DC 10A at 24V DC | SPST | Off-On | Off | Steel Plunger | Snap-On Black Rubber | 2x 7" wire leads | 5/8"-32 thread .625" long | • | PVC-Coated |
| 90043-31 | 90043-31-BX | - | 20A at 12V DC 10A at 24V DC | SPST | Off-On | Off | Steel Plunger | Snap-On Black Rubber | 2 Wire | 5/8"-32 thread .625" long | • | Hencol Sealed Body |

Horn Push Buttons



96101

Surface and clamp mount push-button horn switches. Clamp mount allows attachment on a steering column up to 1-1/2" (38.1mm) diameter.

| PART NUMBERS | | | RATING | TYPE | SIZE | DETAIL | TERMINALS |
|--------------|----------|--------|--------------|---------------|---------|---------------|-----------|
| BULK | BOXED | RETAIL | | | | | |
| 96101 | 96101-BX | - | 5A at 12V DC | Surface Mount | 13/16"Ø | Black Plastic | 2 Screw |

Momentary Push-Button Switches

35-10A • Heavy Duty Marine-Grade Push-Button Switches

For applications to 36V DC. On with button depressed, spring return to Off

Designed for universal applications within harsh environments. Their mounting, body, and actuator features are designed for ease-of-use and extended product lifecycle. With heavy duty brass bodies, the Marine Push Pull Switches are designed for circuit control within the Marine environment.



M-626



M-485

| PART NUMBERS | | | RATING | POLE & THROW | ACTION | NORMAL POSITION | ACTUATOR | TERMINALS | MOUNTING STEM | FITS PANELS | NOTES |
|--------------|-------------|------------------|---|--------------|--------|-----------------|-----------------------------|-----------|----------------------------|---------------------|-------------------------------------|
| BULK | BOXED | RETAIL CLAMSHELL | | | | | | | | | |
| M-490 | M-490-BX | M-490-BP | 35A at 12V DC 20A at 24V DC 10A at 36V DC | SPST | Off-On | Off | Chrome Plated Button | 2 screw | 5/8"-32 thread 1-3/8" long | 1" (25.4mm) thick | - |
| M-612 | M-612-BX | M-612-BP | | SPST | Off-On | Off | Chrome Plated Button | 2 screw | 5/8"-32 thread 1-3/8" long | 1" (25.4mm) thick | With Protected Bezel |
| M-626 | M-626-BX | M-626-BP | | SPST | Off-On | Off | Black Rubber Cap (407-03) | 2 screw | 5/8"-32 thread 1-3/8" long | 1" (25.4mm) thick | Same as M-490, but with snap-on cap |
| M-626-02 | M-626-02-BX | M-626-02-BP | | SPST | Off-On | Off | Black Rubber Cap (83280-03) | 2 screw | 5/8"-32 thread 1-3/8" long | 1" (25.4mm) thick | - |
| M-485 | M-485-BX | M-485-BP | 10A at 12V DC | SPST | Off-On | Off | Chrome Plated Button | 2 Screw | 5/8"-32 thread 1.0" long | 3/4" (19.1mm) thick | Gasket Seal |
| M-492 | M-492-BX | M-492-BP | | SPST | Off-On | Off | Chrome Plated Button | 2 Screw | 5/8"-32 thread 1.0" long | 1" (25.4mm) thick | - |
| M-524 | - | - | | SPST | Off-On | Off | Black Rubber Cap (407-03) | 2 Screw | 5/8"-32 thread 1.0" long | 3/4" (19.1mm) thick | Gasket Seal |
| M-914-01 | M-914-01-BX | - | | SPST | Off-On | On | Chrome Plated Button | 2 Screw | 5/8"-32 thread 1.0" long | 3/4" (19.1mm) thick | - |



90047

Engine Start / Engine Stop Buttons

- Diecast housing, with knurled aluminum facenut
- Two screw terminals with lockwashers
- Mounting stem 7/8"-24 thread, keyed to prevent turning, fits panels .04" - .10" thick (1.0 - 2.5mm)
- Impact-resistant molded plastic button with white imprint, repels oil, water and other liquids
- 2 7/32" L x 1 1/8" D (50.8 x 28.6 x 3.18mm)

| PART NUMBERS | | RATING | POLE & THROW | ACTION | NORMAL POSITION | DETAIL | IMPRINT | TERMINALS | CONTACTS | MOUNTING STEM | SEALING |
|--------------|-------------|---------------|--------------|--------|-----------------|----------------------|---------|-----------|----------|----------------|--------------------------|
| BULK | BOXED | | | | | | | | | | |
| 90047 | 90047-BX | 35A at 12V DC | SPST | Off-On | Off | Black Plastic Button | Start | 2 Screw | Silver | 7/8"-24 thread | - |
| 90047-01 | 90047-01-BX | | SPST | Off-On | Off | Black Plastic Button | Start | 2 Screw | Silver | 7/8"-24 thread | Built-In Seal Around Lip |
| 90048 | 90048-BX | 20A at 24V DC | SPST | Off-On | Off | Red Plastic Button | Stop | 2 Screw | Silver | 7/8"-24 thread | - |
| 90048-01 | 90048-01-BX | | SPST | Off-On | Off | Red Plastic Button | Stop | 2 Screw | Silver | 7/8"-24 thread | Built-In Seal Around Lip |

10A • PVC-Coated Heavy Duty Rectangular Housing Push-Button Switches

For applications to 36V DC. On with button depressed, spring return to Off.

- Corrosion-resistant brass case
- PVC-Coated body sealed against moisture and dirt, with black rubber snap-on cap (407-03)
- Fits panels up to 1/2" (12.7mm) thick

Additional information: littelfuse.com/Push-Button-Switches



| PART NUMBERS | | | RATING | POLE & THROW | ACTION | NORMAL POSITION | ACTUATOR | | TERMINALS | MOUNTING STEM | PVC-COATED |
|--------------|----------|------------------|---------------|--------------|--------|-----------------|--------------|--------|--------------|----------------------------|------------|
| BULK | BOXED | RETAIL CLAMSHELL | | | | | DETAIL | CAP | | | |
| M-608 | M-608-BX | M-608-BP | 10A at 12V DC | SPST | Off-On | Off | Brass Button | Rubber | 2 wire leads | 5/8"-32 thread 15/16" long | • |

5A • Compact Design Buttons

- Moisture-resistant molded plastic case
- Snaps into .80 - .85" (20.3 - 21.6mm) diameter hole. Fits panels .03 - .07" thick (.76 - 1.8mm)
- Normally off black, white or red button compact switch



9075

| PART NUMBERS | | | RATING | POLE & THROW | ACTION | NORMAL POSITION | DETAIL | TERMINALS |
|--------------|---------|------------|--------------|--------------|------------|-----------------|--------------------------|-----------------|
| BULK | BOXED | RETAIL | | | | | | |
| 9075 | 9075-BX | - | 5A at 12V DC | SPST | On-Mom Off | On | Black Plastic 9/16" long | 2 Female Bullet |
| 9187-02 | - | 9187-02-BP | | | Off-Mom On | Off | Red Button | 2 Blade |
| 9187 | 9187-BX | 9187-BP | | | Off-Mom On | Off | Black Button | 2 Blade |

Momentary Push-Button Switches



Threaded and Push Button Caps

- Threaded rubber cap is permanently fastened to the integral mounting nut by a rolled brass bezel
- Snap-on rubber caps feature ribs on the inside of the rubber cap engage with the switch facenut

| PART NUMBERS | | | TYPE | COLOR | IMPRINT | NOTES |
|--------------|-------------|-------------|----------------------------|-------|---------|---|
| BULK | BOXED | RETAIL | | | | |
| 83280 | 83280-BX | - | Screw-On - 5/8"-32 threads | Grey | PUSH | - |
| 83280-02 | 83280-02-BX | - | Screw-On - 5/8"-32 threads | Red | PUSH | - |
| 83280-03 | 83280-03-BX | 83280-03-BP | Screw-On - 5/8"-32 threads | Black | PUSH | - |
| 83280-05 | 83280-05-BX | - | Screw-On - 5/8"-32 threads | Brown | PUSH | Molded from Hydrin which is more resistant to fuel and oils |
| 407-01 | - | - | Snap-On | Grey | PUSH | Snaps on to 83261 face nut |
| 407-02 | - | - | Snap-On | Red | PUSH | Snaps on to 83261 face nut |
| 407-03 | 407-03-BX | 407-03-BP | Snap-On | Black | PUSH | Snaps on to 83261 face nut |

Momentary Door Switches

10A • Specialized Door Momentary Switches



91811



91800

- Designed for 8 light warning systems in school buses.
- 91811: Two circuits, progressive plunger travel alternates the circuits.
- 91800: Pull out feature permits circuit to be shut off manually when the door must remain open but flashing lights operation is not required.

Additional information: littelfuse.com/Door-Switches



| PART NUMBERS | | RATING | POLE & THROW | POSITIONS | ACTION | NORMAL POSITION | ACTUATOR | | TERMINALS | CASE | CONTACTS | MOUNTING |
|--------------|----------|---------------|--------------|-----------|---------------------|-----------------|----------|----------------------|-----------|--------------|----------|--|
| BULK | BOXED | | | | | | DETAIL | LENGTH | | | | |
| 91800 | 91800-BX | 10A at 12V DC | SPST | 3 | Mom Off-On-Pull Off | On | Button | 7/32" On 3/4" Off | 2 Screw | Plated Steel | Silver | 7/16"-20 thread, 7/16" long Two Flats for Double-D Mounting |
| 91050 | 91050-BX | - | TPTT | 2 | On-Mom Off | On | Button | 3/10" | 8 Blade | Plated Steel | Silver | 7/16"-20 thread, 7/16" long Two Flats for Double-D Mounting |

10

5A • Door Momentary Switches with Faceplate

Additional information: littelfuse.com/Door-Switches



9001 / 9002

9087



9270 / 9269

| PART NUMBERS | | RATING | POLE & THROW | ACTION | NORMAL POSITION | ACTUATOR | | | TERMINALS | CASE | CONTACTS | MOUNTING |
|--------------|------------|--------------|--------------|------------|--|----------|--------|--------|-----------|--------------|----------|---|
| BULK | BOXED | | | | | DETAIL | LENGTH | D/A. | | | | |
| 9001 | 9001-BX | 5A at 12V DC | SPST | On-Mom Off | Normally On | Rounded | 7/16" | 45/64" | 2 Screw | Plated Steel | Silver | Two 9/64"Ø Mounting Holes 1-3/8" on Center |
| 9050-01 | 9050-01-BX | | | | | | | | 1 Screw | | | Two 9/64"Ø Mounting Holes 1-3/8" on Center |
| 9270 | 9270-BX | | | | | | | | 2 Blade | | | Two 9/64"Ø Mounting Holes 1-3/8" on Center |
| - | 9087-BX | | | 2 Screw | Four 3/16"Ø Mounting Holes 1-3/8" and 2-1/16" on Center | | | | | | | |
| - | 9002-BX | | | 2 Screw | Two 9/64"Ø Mounting Holes 1-3/8" on Center | | | | | | | |
| 9269 | 9269-BX | | | 2 Blade | Two 9/64"Ø Mounting Holes 1-1/2" on Center | | | | | | | |

Momentary Door Switches

10-5A • SPST • Door Momentary Switches

Additional information: littelfuse.com/Door-Switches



9264



9003

| PART NUMBERS | | RATING | POLE & THROW | POSITIONS | ACTION | NORMAL POSITION | ACTUATOR | | TERMINALS | CASE | CONTACTS | MOUNTING |
|--------------|------------|---------------|--------------|-----------|------------|-----------------|----------|--------|--|--------------|----------|--|
| BULK | BOXED | | | | | | DETAIL | LENGTH | | | | |
| 9055 | 9055-BX | 10A at 12V DC | SPST | 2 | On-Mom Off | On | Shaft | 1/2" | 2 Screw | Plated Steel | Silver | 7/16"-20 thread, 7/16" long Two Flats for Double-D Mounting |
| 9264 | 9264-BX | 10A at 12V DC | | | | | Button | 1/2" | | | | 7/16"-20 thread, 7/16" long Two Flats for Double-D Mounting |
| 9264-04 | - | - | | | | | Button | 7/16" | | | | - |
| 9264-02 | 9264-02-BX | 10A at 12V DC | | | | | Button | 1/2" | | | | 7/16"-20 thread, 7/8" long Two Flats for Double-D Mounting |
| 9003 | 9003-BX | 5A at 12V DC | | | | | Rounded | 3/32" | 1/2"-20 thread 1/14" long | | | |
| 9055-08 | - | 20A at 12V DC | | | | | Shaft | 1/2" | 2 Blade 7/16"-20 thread, 7/8" long Two Flats for Double-D Mounting | | | |

10A • DPST • Door Momentary Switches

- Energizes two circuit simultaneously.
- Popular for use in school bus stepwell and door control.

Additional information: littelfuse.com/Door-Switches



9118/9180



91801

| PART NUMBERS | | RATING | POLE & THROW | POSITIONS | ACTION | NORMAL POSITION | ACTUATOR | | TERMINALS | CASE | CONTACTS | MOUNTING |
|--------------|------------|---------------|--------------|-----------|------------|-----------------|----------|--------|-----------|--------------|----------|--|
| BULK | BOXED | | | | | | DETAIL | LENGTH | | | | |
| 9118 | 9118-BX | 10A at 12V DC | DPST | 2 | On-Mom Off | On | Button | 19/64" | 4 Screw | Plated Steel | Silver | 7/16"-20 thread, 7/16" long Two Flats for Double-D Mounting |
| 91801 | 91801-BX | 10A at 12V DC | DPST | 2 | On-Mom Off | On | Button | 19/64" | 4 Blade | | | |
| 9180 | 9180-BX | 10A at 12V DC | DPST | 2 | Off-Mom On | Off | Button | 15/32" | 4 Screw | | | |
| 9118-04 | 9118-04-BX | 10A at 12V DC | DPST | 2 | On-Mom Off | On | Button | 19/64" | 4 Screw | | | 7/8"-20 thread, 7/8" long Two Flats for Double-D Mounting |

5A • Normally Grounded Single Circuit Door Momentary Switches

Additional information: littelfuse.com/Door-Switches



91812

| PART NUMBERS | | RATING | POLE & THROW | ACTION | NORMAL POSITION | ACTUATOR | | TERMINALS | CASE | CONTACTS | MOUNTING |
|--------------|----------|--------------|--------------|------------|-------------------|-----------------------|-------------------|-----------|--------------|----------|--|
| BULK | BOXED | | | | | DETAIL | LENGTH | | | | |
| 91812 | 91812-BX | 5A at 12V DC | SPST | On-Mom Off | Normally Grounded | Rounded | 33/64" | 1 Blade | Plated Steel | Silver | 7/16"-20 thread, 7/16" long Two Flats for Double-D Mounting |
| 91812-02 | - | | | | | Chrome Plated Plunger | 1 Blade 1 Wire | | | | |

10

5A • Sealed Door Momentary Switches with Faceplate

- Sealed Plunger and wire leads.

Additional information: littelfuse.com/Door-Switches



9270-01

| PART NUMBERS | | RATING | POLE & THROW | ACTION | NORMAL POSITION | ACTUATOR | | | TERMINALS | CASE | CONTACTS | MOUNTING |
|--------------|------------|--------------|--------------|------------|-----------------|------------------------|--------|------|----------------------------|--------------|----------|--|
| BULK | BOXED | | | | | DETAIL | LENGTH | DIA. | | | | |
| 9270-01 | 9270-01-BX | 5A at 12V DC | SPST | On-Mom Off | Normally On | Round Black Rubber Cap | .436" | .70" | 2 PVC Coated 8" Wire Leads | Plated Steel | Silver | Two .144"Ø Mounting Holes 1-1/2" on Center |

Push-Pull, Rotary & Foot Switches



What is the Difference Between Push-Pull, Rotary & Foot Switches?

Push-Pull switches operate by pushing or pulling the actuator depending on the configuration of the switch.

Rotary switches are activated by a manual rotation of the actuator into two or three positions.

Foot switches are mounted on or through the floorboard for hands free operation of the application

What is Dynamic Parking in Wiper Switches?

Windshield wiper switch engineers call the feature 'dynamic parking' when the windshield wiper switch actively returns the wiper to home position, rather than waiting until the cycle reaches home.



Push-Pull Switches

One and Two Circuit Push-Pull Switches



| PART NUMBERS | | VOLTAGE | RATING | CIRCUITRY | TYPE | NORMAL POSITION | ACTUATOR KNOB | TERMINALS | CONTACTS | HOUSING | MOUNTING STEM | | NOTES |
|--------------|----------|----------|---------------|-----------|-------------|-----------------|---|------------------|----------|--------------|---------------|-------------------------------|---|
| BULK | BOXED | | | | | | | | | | MATERIAL | SIZE | |
| 5007 | 5007-BX | 6-36V DC | 10A at 12V DC | SPST | Off-On | Off | Tan Plastic (10-32 metal thread) | 2 screw | Copper | Plated Steel | Aluminum | 3/8"-32 thread 5/8" long | - |
| 5011 | 5011-BX | | 10A at 12V DC | SPST | Off-On | Off | Chrome | 2 screw | Copper | Plated Steel | Steel | 1/2"-20 thread 5/8" long | - |
| 50070 | 50070-BX | | 10A at 12V DC | SPST | Off-On | Off | Chrome | 2 blade | Silver | Plated Steel | Steel | 1/2"-20 thread 5/8" long | - |
| 50001 | 50001-BX | | 10A at 12V DC | SPST | Off-On | Off | Black Plastic (10-32 metal thread) | 2 screw | Silver | Plated Steel | Brass | 1/2"-20 thread 5/8" long | - |
| 50002 | 50002-BX | | 20A at 12V DC | SPST | Off-On | Off | Integral Chrome Brass | 2 screw | Silver | Plated Steel | Brass | 1/2"-20 thread 5/8" long | - |
| 50066 | 50066-BX | | 20A at 12V DC | SPST | Off-On | Off | Black Plastic (10-32 metal thread) | 2 screw | Silver | Plated Steel | Brass | 1/2"-20 thread 5/8" long | O-Ring stem seal & Gasket Sealed Terminal Insulator |
| 50046 | 50046-BX | | 10A at 12V DC | SPST | On-Off | On | Black Plastic (10-32 metal thread) | 2 screw | Copper | Plated Steel | Aluminum | 3/8"-32 thread 5/8" long | - |
| 50046-09 | - | | 10A at 12V DC | SPST | On-Off | On | Plunger | 2 screw | Copper | Plated Steel | Aluminum | 3/8"-32 thread 5/8" long | - |
| 5050 | - | | 20A at 12V DC | DPST | On-Off | Off | Black Plastic "Lights" (10-32 metal thread) | 2 screw & 1 stud | Silver | Plated Steel | Steel | 1/2"-20 thread 5/8" long | Includes 30A Circuit Breaker |
| 50082 | 50082-BX | | 8A at 12V DC | SPDT | Off-On1-On2 | - | Integral Chrome | 3 blade | Copper | Plated Steel | Steel | 1/2"-20 thread 5/8" long | Energize two circuits from a common feed |
| 50088 | 50088-BX | | 8A at 12V DC | TPTT | Off-On-Off | On | Steel Plunger | 3 screw | Silver | Plated Steel | Aluminum | 7/16"-28 thread 5/16" long | - |
| 91812-02 | - | | 5A at 12V DC | SPST | On-Mom Off | On | Chrome Plunger | 1 blade & 1 wire | Silver | Plated Steel | Steel | 7/16"-20 thread 7/16" long | - |

Marine Grade • One, Two & Three Circuit Push-Pull Switches



| PART NUMBERS | | | VOLTAGE | RATING | CIRCUITRY | TYPE | NORMAL POSITION | ACTUATOR KNOB | TERMINALS | CONTACTS | HOUSING | GASKET SEALED | MOUNTING STEM | |
|--------------|----------|----------|----------|---------------|-----------|---------------|-----------------|-----------------------------|-----------------------|----------|--------------------|---------------|---------------|------------------------|
| BULK | BOXED | RETAIL | | | | | | | | | | | MATERIAL | SIZE |
| M-482 | M-482-BX | M-482-BP | 6-36V DC | 10A at 12V DC | SPST | Off-On | Off | Chrome Brass | 2 screw | - | Brass | • | Brass | 3/8"-32 1 1/4" long |
| M-606 | M-606-BX | M-606-BP | 6-36V DC | 10A at 12V DC | SPST | Off-On | Off | Chrome Brass (10-32 thread) | 2 copper 12" wires | - | Brass - PVC Coated | | Brass | 3/8"-32 1 1/4" long |
| M-628 | M-628-BX | M-628-BP | 6-36V DC | 10A at 12V DC | SPST | Off-On | Off | Chrome Brass (10-32 thread) | 2 screw | - | Brass | | Brass | 3/8"-32 1 1/4" long |
| M-530 | M-530-BX | - | 6-36V DC | 10A at 12V DC | SPST | On-Off | On | Chrome Brass | 2 screw | - | Brass | • | Brass | 3/8"-32 1 1/4" long |
| M-527 | - | M-527-BP | 6-36V DC | 10A at 12V DC | SPST | On-Off | Off | Chrome Brass | 3 screw | - | Brass | | Brass | 3/8"-32 1 1/4" long |
| M-531 | M-531-BX | M-531-BP | 6-36V DC | 10A at 12V DC | SPST | On-On-Off | Off | Chrome Brass (10-32 thread) | 3 screw | - | Brass | | Brass | 3/8"-32 1 1/4" long |
| M-630 | M-630-BX | - | 6-36V DC | 10A at 12V DC | SPDT | On-On | Off | Chrome Brass | 3 screw | - | Brass | | Brass | 3/8"-32 1 1/4" long |
| M-532 | M-532-BX | M-532-BP | 6-36V DC | 10A at 12V DC | SPDT | Off-On1-On2 | Off | Chrome Brass (10-32 thread) | 4 screw | - | Brass | | Brass | 3/8"-32 1 1/4" long |
| M-476 | M-476-BX | M-476-BP | 6-36V DC | 10A at 12V DC | SPDT | Off-On1-On1&2 | Off | Chrome Brass | 3 screw | - | Brass | | Brass | 3/8"-32 1 1/4" long |

11

Push-Pull Switches

Push-Pull Headlamp Switches

- Three knob pull positions: In – Mid – Out
- In = Headlamps Off
- Mid = Parking Lights and Tail Lights On
- Out = Headlights and Tail Lights On



Additional information: littelfuse.com/PushPullSwitches



| PART NUMBERS | | RATING PER CIRCUIT | POSITIONS | TYPE | ACTUATOR | | TERMINALS | CONTACTS | HOUSING | MOUNTING STEM | NOTES |
|--------------|-------------|-------------------------------------|------------|------------------|---------------|----------|-----------|--------------|--------------|---|--|
| BULK | BOXED | | | | KNOB | IMPRINT | | | | | |
| 7124 | 7124-BX | 15A at 12V DC | 3 | In-Mid-Out | Black Plastic | Lights | 4 screw | Copper | Plated Steel | 7/16"-28 | - |
| 7124-06 | 7124-06-BX | | | In-Mid-Out | Black Plastic | Lights | 4 screw | Bronze | Plated Steel | 7/16"-28 | |
| 72100 | 72100-BX | 20A at 12V DC | | In-Mid-Out | Black Plastic | Lights | 4 screw | Silver | Diecast | 7/16"-28 | O-Ring Seal in Stem & Gasket Sealed Terminal Insulator |
| 7152 | 7152-BX | 15A at 12V DC | | In-Mid-Out | Ivory Plastic | Lights | 4 screw | Silver | Plated Steel | 3/8"-24 | - |
| 7157 | 7157-BX | 30A at 12V DC with Breaker | | In-Mid-Out | Ivory Plastic | Lights | 3 screw | Silver | Plated Steel | 7/16"-28 | Includes 30A Circuit Breaker |
| 7127 | 7127-BX | 20A at 12V DC with Fuse | | In-Mid-Out | Black Plastic | Lights | 4 screw | Copper | Plated Steel | 7/16"-28 | Includes 20A Glass Fuse |
| 71092 | 71092-BX | 15A at 12V DC with Internal Breaker | | In-Mid-Out | None | None | 8 blade† | - | Plated Steel | 7/16"-28 | 4.5 Ω with Internal 15A Circuit Breaker |
| 71092-02 | 71092-02-BX | 15A at 12V DC with Internal Breaker | In-Mid-Out | None | None | 8 blade† | - | Plated Steel | 7/16"-28 | 4.5 Ω with Internal 15A Circuit Breaker | |
| 7112 | 7112-BX | 10A at 12V DC | 4 | In-Mid1-Mid2-Out | Tan Plastic | Lights | 5 screw | Copper | Plated Steel | 3/8"-24 | - |

†Accepts Delphi 2977645 or 2984169

Specialized Push-Pull Switches



68028



50036



50203



9576

| PART NUMBERS | | VOLTAGE | POSITIONS | TYPE | ACTUATOR KNOB | TERMINALS | CONTACTS | HOUSING | MOUNTING STEM | | NOTES |
|--------------|----------|-----------------------|-----------|--|---|-----------------|----------|---|---------------|----------------------------|--|
| BULK | BOXED | | | | | | | | MATERIAL | SIZE | |
| 68028 | 68028-BX | 12V DC | 3 | Off-Hi-Lo | Ivory Plastic (10-32 Metal Thread) Gold Imprint: Lights | 2 screw | Copper | Plated Steel (1-13/16"x 1-19/32"x 1/2") | Steel | 7/16"-28 thread 5/16" long | Heater switch 3Ω coil resistance |
| 50036 | 50036-BX | 12V DC | 2 | On-On (DPST) | Red Plastic 1-1/4" Ø | 3 female bullet | Copper | Zinc with Rubber Boot | - | - | Two-speed axle switch to mount on gear shift lever Accepts 40102 connector |
| 50203 | - | 10A at 12V 36V DC max | 2 | In-Off (Magneto Switch Grounded) Out-Run (Magneto Switch Open) | Integral Nickel Plated | 1 screw | Copper | Plated Steel | Aluminum | 3/8"-32 thread 5/8" long | Magneto Switch, Out-Run |
| 9576 | 9576-BX | 12V DC | 2 | Off-Ign/Acc-Ign/Start 10A Acc, 5A Ign, 5A Start | Black Plastic | 4 screw | Copper | Plated Steel | Steel | 3/8"-24 thread | Battery ignition and starter switch - spring return to Ign/Acc |
| 9011 | 9011-BX | - | 2 | Off-Start | Chrome Plated Button | 2 screw | Copper | Plated Steel | Steel | 1"-22 thread 17/32" long | Engine Start / Engine Stop Button |

Rotary Switches

Universal Rotary Switches

In a full range of styles and circuitries for lighting, ignition and similar applications.

- For forward-reverse operation of a motor, to give a motion such as Up/Down, Left/Right, In/Out, Rotate/Counter-rotate
- Suitable for control of tailgates, winches, windlasses, snowplows and other applications

Additional information: littelfuse.com/RotarySwitches



| PART NUMBERS | | RATING | CIRCUITRY | POSITIONS | SWITCH TYPE | TYPE | ACTUATOR | TERMINALS | HOUSING | MOUNTING STEM | NOTES |
|--------------|-------------|---------------|-----------|-----------|---------------------|--|-----------------------------|----------------------|--------------|---------------|--|
| BULK | BOXED | | | | | | | | | | |
| 9500 | 9500-BX | 10A at 12V DC | SPST | 2 | – | Off-On | Lever | 2 screw | Plated Steel | ½"-20 | Compact Case |
| 24054 | – | 10A at 12V DC | SPST | 3 | – | On1-Off-On2 | Lever | 3 screw | Plated Steel | ½"-20 | – |
| 75701 | 75701-BX | 20A at 12V DC | – | 3 | Reverse | On1-Off-On2 | Lever | 3 screw | Plated Steel | 7/16"-28 | – |
| 72171-02 | – | 20A at 12V DC | – | 3 | Rotary | Off-On-On | Black Knob (Fan Icon) | 6 blade | Copper | 11/32"-12 | Universal rotary or fan control types of products |
| 75602-10 | – | 24V DC | – | 4 | – | – | Aptiv 2977042 | 6 Way Male Connector | Diecast | 13/16"-24 | – |
| 90005-01 | 90005-01-BX | 15A at 12V DC | DPDT | 3 | Reverse | On (Reverse); Off; On (Forward) | Lever | 4 screw | Plated Steel | ½"-20 | Spring Return to Off |
| 75705-01 | 75705-01-BX | 10A at 12V DC | – | 3 | Momentary | Mom On1-Off-Mom On2 | Key with Coded Tumbler Lock | 3 screw | Plated Steel | 13/16"-24 | Internal O-Ring Seal; Spring Return to Off from Both Positions |
| 90005-03 | 90005-03-BX | 15A at 12V DC | DPDT | 3 | Reversing | Off (Reverse)-Off-On (Forward) | Key with Coded Tumbler Lock | 4 screw | Plated Steel | 13/16"-24 | O-Ring Seal in Stem |
| 75712-04 | 75712-04-BX | 50A at 12V DC | DPDT | 3 | Momentary Reversing | Mom Off (Reverse)-Off-Mom On (Forward) | Lever | 4 screw 3/32" thick | Plated Steel | ½"-20 | High Amp Silver Contacts |

Rheostat Switches



Ceramic insulator with embedded coil for effective heat dissipation.

Additional information: littelfuse.com/RotarySwitches



| PART NUMBERS | | VOLTAGE | RESISTANCE | POSITIONS | ACTUATOR | | TERMINALS | HOUSING | MOUNTING STEM | DIMENSIONS |
|--------------|---------|---------|------------|-----------|------------------------|-------------|-----------|--------------|---------------|---|
| BULK | BOXED | | | | KNOB | IMPRINT | | | | |
| 7493 | 7493-BX | 12V DC | 8 Ohms | 3 | Black Plastic Bar Knob | – | 2 screw | Plated Steel | 7/16"-28 | 1.32"Ø .88" long (33.5mm Ø 22.4mm long) |
| 7493-07 | – | 12V DC | 8 Ohms | 3 | Black Plastic Bar Knob | Panel Lamps | 2 screw | Plated Steel | 15/32" long | |



Heater-Defroster Switches

Coil embedded in ceramic insulator for effective heat dissipation.

| PART NUMBERS | | VOLTAGE | RESISTANCE | POSITIONS | TYPE | ACTUATOR | TERMINALS | MOUNTING HOLE |
|--------------|----------|---------|------------|-----------|---------------------|------------------------|-----------|-------------------|
| BULK | BOXED | | | | | | | |
| 68362 | 68362-BX | 12V DC | 3 Ohms | 4 | Off-High-Medium-Low | Black Plastic Bar Knob | 2 screw | 5/8" Through-Hole |

Rotary Wiper Switches

Electronic Windshield Wiper Switches

Universal application. For stem- or bracket-mounting. 15/32"-32 thread mounting stem, with keyway.

- Intermittent delay feature for permanent magnet electric wiper motors
- Negative ground only
- Four positions: Off/Park - Intermittent Range - Low - High
- 7/16"-28 x .45" (11.3mm)
- Round black plastic, white imprinted knob with metal insert and set screw included unless noted otherwise
- Controls single motor unless noted otherwise
- Conforms to SAE J1455, SAE J112a, and SAE J234

Additional information: littelfuse.com/WiperSwitches



| PART NUMBERS | | | VOLTAGE | POSITIONS | CONNECTOR | HOUSING | DIMENSIONS | DYNAMIC PARKING | PUSH-TO-WASH | NOTES |
|--------------|-------------|--------|---------|-----------|--|---------|--|-----------------|--------------|--|
| BULK | BOXED | RETAIL | | | | | | | | |
| 75600 | - | - | 12V DC | 4 | Delphi 2965977 8-way female connector | Diecast | 2 7/32" x 2 7/32" x 1 13/16" (56.4mm x 56.4mm x 46.0mm) | • | • | - |
| 75600-01 | 75600-01-BX | - | 12V DC | | Delphi 6294544 4-way male and Delphi 2977042 6-way male connectors | | | •† | • | Controls two motors in phase at the same speed |
| 75600-02 | 75600-02-BX | - | 12V DC | | Delphi 2977042 6-way male connector | | | • | • | - |
| 75600-04 | 75600-04-BX | - | 12V DC | | Color-coded leads | | | • | • | - |
| 75600-05 | - | - | 12V DC | | Delphi 6294544 4-way male and Delphi 2977048 4-way female connectors | | | • | • | - |
| 75600-07 | 75600-07-BX | - | 12V DC | | 7 pole connector | | | • | • | - |
| 75602-02 | - | - | 24V DC | | Delphi 6294544 4-way male and Delphi 2977042 6-way male connectors | | | •† | • | Controls two motors in phase at the same speed |
| 75600-25 | - | - | 12V DC | | Six Pin AMP Connector #640585-1 | | | | • | - |
| 75601-14 | 75601-14-BX | - | 12V DC | | Delphi (Packard) 8-way male connector 2965972 (mates with 2965977). | | | | • | Controls one or two motors |
| 75603-09 | - | - | 24C DC | 5 | Nine Pin AMP 1-480707-0 Connector | | • | - | | |

† = with or without dynamic parking (based on motor capabilities)

Electric Windshield Wiper Switches

Universal application. For through hole and panel mounting. 15/32"-32 thread mounting stem, with keyway.

- Three positions: Off/Park - Low - High
- 7/16"-28 x .45" (11.3mm) mounting stem unless noted otherwise
- Round black plastic, white imprinted knob with metal insert and set screw included unless noted otherwise
- Controls single motor unless noted otherwise

Additional information: littelfuse.com/WiperSwitches



| PART NUMBERS | | | VOLTAGE | POSITIONS | TERMINALS | HOUSING | MOUNTING STEM | DIMENSIONS | DYNAMIC PARKING | PUSH-TO-WASH | NOTES |
|--------------|-------------|--------|---------------|-----------|-----------|--------------|-------------------------|------------------------------------|-----------------|--------------|---------------------------------------|
| BULK | BOXED | RETAIL | | | | | | | | | |
| 68159-05 | 68159-05-BX | — | 12V DC | 3 | 5 blade | Plated steel | 7/16"-28 x .38" (9.6mm) | 1 3/8" Ø x 3/8" (34.9mm Ø x 9.5mm) | | | No electrical break between positions |
| 75212-04 | 75212-04-BX | — | 12V or 24V DC | 3 | 4 blade | Plated steel | 7/16"-28 x .38" (9.6mm) | 1 3/8" Ø x 3/8" (34.9mm Ø x 9.5mm) | | • | — |
| 75217-04 | — | — | 12V or 24V DC | 3 | 6 blade | Plated steel | 7/16"-28 x .38" (9.6mm) | 1 3/8" Ø x 3/8" (34.9mm Ø x 9.5mm) | | | Controls two motors |
| 75221-06 | 75221-06-BX | — | 12V DC | 3 | 4 blade | Plated steel | 7/16"-28 x .38" (9.6mm) | 1 3/8" Ø x 3/8" (34.9mm Ø x 9.5mm) | | | Internal 6A circuit breaker |
| 75221-09 | 75221-09-BX | — | 12V DC | 3 | 5 blade | Plated steel | 7/16"-28 x .38" (9.6mm) | 1 3/8" Ø x 3/8" (34.9mm Ø x 9.5mm) | | • | Internal 6A circuit breaker |
| 75226 | 75226-BX | — | 12V or 24V DC | 3 | 7 blade | Plated steel | 7/16"-28 x .38" (9.6mm) | 1 3/8" Ø x 3/8" (34.9mm Ø x 9.5mm) | | • | Controls two motors |
| 75228-03 | 75228-03-BX | — | 12V or 24V DC | 3 | 6 blade | Diecast | 7/16"-28 x .38" (9.6mm) | 1 5/8" Ø (41.3mm Ø) | • | • | — |
| 75228-04 | 75228-04-BX | — | 12V or 24V DC | 3 | 5 blade | Diecast | 7/16"-28 x .38" (9.6mm) | 1 5/8" Ø (41.3mm Ø) | • | | — |
| 75236 | 75236-BX | — | 12V or 24V DC | 3 | 8 blade | Diecast | 7/16"-28 x .38" (9.6mm) | 1 5/8" Ø (41.3mm Ø) | • | • | Controls two motors |

Wiper Switch Accessories



81298-02



81298-34

| PART NUMBERS | | IMPRINT | FACE DIAMETER | MATERIAL |
|--------------|-------------|-------------------------|---------------|---------------|
| BULK | BOXED | | | |
| 81298-02 | 81298-02-BX | SAE wiper symbol | 1 3/16" Ø | Black plastic |
| 81298-34 | 81298-34-BX | SAE wiper-washer symbol | 1 3/16" Ø | Black plastic |

Rotary Headlamp Switches



Headlamp Dimmer Switches

- For variable intensity control of lighting applications
- For use in negative ground systems
- Black plastic knob with metal insert and set screw
- Knob imprinted in white with SAE variable symbol
- Diecast case: 1 9/16" Ø (39.7mm) by .883" (22.4mm) long

Additional information: littelfuse.com/RotarySwitches

| PART NUMBERS | | | RATING | DUTY CYCLE | CONNECTOR | CASE | | MOUNTING STEM |
|--------------|-------------|-------------|----------------|---------------------|---|--------------|--|---------------------------------------|
| BULK | BOXED | RETAIL | | | | MATERIAL | DIMENSIONS | |
| 74600-02 | - | 74600-02-BP | 4A at 12V DC | 0-100% | 3 wire (Load, Battery & Ground) Delphi 2984378 connector on 3" (76.2mm) leads | Diecast | 1 9/16" Ø x .883" 39.7mm Ø x 22.4mm | 7/16"-28 thread .45" (11.4mm) long |
| 74601-01 | 74601-01-BX | 74601-01-BP | 7A at 12V DC | 1-99% | 2 wires (Load & Battery) 1 25/32" (45.2mm) long | Diecast | 1 9/16" Ø x .883" 39.7mm Ø x 22.4mm | 7/16"-28 thread .45" (11.4mm) long |
| 74603 | 74603-BX | - | 6A at 12V DC | 1-99% | 2 wires 2" (50.8mm) long two AMP connectors (load 480054-3, battery 480053-3) | Diecast | 1 9/16" Ø x .883" 39.7mm Ø x 22.4mm | 7/16"-28 thread .45" (11.4mm) long |
| 74601-06 | - | - | 7A at 14.7V DC | 18% - 45% +/- 5% | TYCO Terminal #3-520106-2 | Plated Steel | 1 9/16" Ø x .883" 39.7mm Ø x 22.4mm | 7/16"-28 thread .45" (11.4mm) long |
| 74601-12 | - | - | 7A at 14.7V DC | - | 2 Terminated Wire TE Connectivity 3-520106-2 | Plated Steel | 1 9/16" Ø x .883" 39.7mm Ø x 22.4mm | 7/16"-28 thread .45" (11.4mm) long |



72079-01

Rotary Headlamp Switches

Additional information: littelfuse.com/RotarySwitches



| PART NUMBERS | | RATING PER CIRCUIT | POSITIONS | ACTUATOR | | TERMINALS | CONTACTS | HOUSING | MOUNTING STEM | NOTES |
|--------------|-------|--------------------|-----------|---------------|----------------------|-----------|----------|--------------|----------------|---------------------|
| BULK | BOXED | | | KNOB | IMPRINT | | | | | |
| 72079-01 | | 20A at 12V DC | 4 | Black Plastic | SAE Headlight Symbol | 5 screw | Silver | Plated Steel | 5/8"-32 thread | O-Ring Seal in Stem |

Foot Operated Switches



7785

7792

Foot Operated Turn Switches

Depress to On, spring return to Off. Two switches are needed for left and right turn signals. Plastic-coated, providing protection against moisture, dust and roadsplash.

Additional information: littelfuse.com/FootSwitches

| PART NUMBERS | | CIRCUITRY | TYPE | NORMAL POSITION | TERMINALS | HOUSING | MOUNTING | | STEM SIZE | NOTES |
|--------------|------------|-----------|---|-----------------|--------------|--------------------|--------------------|---|-----------|--------|
| BULK | BOXED | | | | | | TYPE | HOLES | | |
| 7792 | 7792-BX | SPST | Off-On | Normally Off | 2 screw | Diecast PVC Coated | Through-Floorboard | 3x 1/4"-20 tapped holes 3/4" and 1-3/4" on centers | 7/8" Ø | Sealed |
| 7792-01 | 7792-01-BX | | Depress to On, spring return to Off. | Normally Open | 2 Screw | Diecast PVC Coated | Through-Floorboard | 3x 1/4"-20 tapped holes 3/4" and 1-3/4" on centers | 7/8" Ø | - |
| 7792-03 | - | | On-Off | Normally Open | 2 Wire Leads | Diecast PVC Coated | Through-Floorboard | 3x 1/4"-20 tapped holes 3/4" and 1-3/4" on centers | 7/8" Ø | - |

Foot Operated Switches

Foot Operated Headlamp Dimmer Switches

Depress-release for low beam, depress-release for high beam. Corrosion-resistant diecast metal housings, moisture-repellent insulators.

Additional information: littelfuse.com/FootSwitches



7700



7786



7787



7762

| PART NUMBERS | | CIRCUITRY | TYPE | TERMINALS | CONNECTOR | HOUSING | MOUNTING | | STEM SIZE |
|--------------|------------|-----------|--------|------------------------|----------------------------|--------------------|---|--|-----------|
| BULK | BOXED | | | | | | TYPE | HOLES | |
| 7700 | 7700-BX | SPDT | On-On | 3x 16 AWG (5.75" long) | - | PVC Coated Diecast | Through-Floorboard | 3x 1/4"-20 tapped holes 3/4" and 1-3/4" on centers | 27/32" Ø |
| 7786 | 7786-BX | | - | 3 screw | - | Diecast | | 3x 1/4"-20 tapped holes 3/4" and 1-3/4" on centers | 1-1/16" Ø |
| 7784 | 7784-BX | | On-On | 3 screw | - | Diecast | | 3x 1/4"-20 tapped holes 3/4" and 1-3/4" on centers | 7/8" Ø |
| 7785-01 | - | | On-Off | - | Packard Connector 12015792 | PVC Coated Diecast | | 3x 1/4"-20 tapped holes 3/4" and 1-3/4" on centers | 7/8" Ø |
| 7786-01 | - | | On-On | - | Aptiv 12015793 | PVC Coated Diecast | | 3x 1/4"-20 tapped holes 3/4" and 1-3/4" on centers | 7/8" Ø |
| 7786-03 | - | | - | 3 wire leads | - | Diecast | | 3x 1/4"-20 tapped holes 3/4" and 1-3/4" on centers | - |
| 7789-02 | 7789-02-BX | | - | 3 blade | - | Diecast | | 3x 1/4"-20 tapped holes 3/4" and 1-3/4" on centers | 55/64" |
| 7787 | 7787-BX | | - | 3 screw | - | Diecast | 2x 1/4"-20 tapped holes 1-3/4" on centers | 7/8" Ø | |
| 7762 | 7762-BX | | - | 3 blade | 30155 | Diecast | On-Floorboard | 2x 9/32"Ø holes 1-3/4" on centers | - |



9060



9183

Foot Operated Starter Switches

Off-On, normally Off. Depress to On, spring return to Off.

Additional information: littelfuse.com/FootSwitches

| PART NUMBERS | | CIRCUITRY | TYPE | NORMAL POSITION | TERMINALS | MOUNTING | | PLUNGER | NOTES | |
|--------------|----------|-----------|--------|-----------------|--|--------------------|--|-------------|--|-------------------|
| BULK | BOXED | | | | | TYPE | HOLES | | | |
| 9060 | 9060-BX | SPST | Off-On | Normally Off | 2x 5/16"-24 studs with hexnuts & washers | Through-Floorboard | 2x 9/32"Ø holes 1-3/4" on centers | 1.83" Long | Autolite SW-40001 (15-47), 15-50, 401A, 4002, 4005, 4010, 4015 (15-51) | Delco D900 (405C) |
| 9183 | 9183-BX | | | | | | 2x 9/32"Ø holes 1-3/4" on centers | 1" Long | Autolite SW-4012 (15-49) | Delco 1996478 |
| 91001 | 91001-BX | | | | | | 2x 7/32" tapped holes 23/32" on center | 21/32" long | 16 thread and 32 thread terminal posts on body of switch | |

Specialty Switches

Backup Switches

- See table below for replacement suitability
- Normally off, on with plunger depressed, spring return to Off

Additional information: littelfuse.com/BackupSwitches



91113



75125



9052

| PART NUMBERS | | RATING | POLE & THROW | ACTION | NORMAL POSITION | ACTUATOR | MOUNTING | DETAIL | TERMINALS |
|--------------|----------|---------------|--------------|--------|-----------------|---|---|---|----------------------|
| BULK | BOXED | | | | | | | | |
| 91113 | 91113-BX | 20A at 12V DC | SPST | Off-On | Normally Off | Ball | On vehicle transmission | Spring return to Off | 2 screw |
| 75125 | - | - | SPST | Off-On | Normally Off | 5" lever | Two 13/64" (5.2mm) Ø mounting holes, 1/2" (12.7mm) on centers | Back-up alarm switch Spring return to Off | 2 screw |
| 9052 | 9052-BX | 10A at 12V DC | SPST | Off-On | - | Button-Head 1/2" (12.7mm) long | 7/16" (7.9mm) Ø mounting stem, 7/16" -20 (7.9mm) long, with two flats for mounting in double-D hole | Spring return to Off | 2 screw |
| 91105 | 91105-BX | 10A at 12V DC | SPST | Off-On | Normally Off | Button-head actuator, 3/8" (9.5mm) long | 3/8 (9.5mm) long. 7/16 -20 (7.9mm) diameter mounting stem | On with plunger depressed, spring return to Off | 2 - 18AWG Wire Leads |

Stoplamp Switches

- See table below for replacement suitability

Additional information: littelfuse.com/StoplampSwitches



8626



8629



8645



8715



8487

| PART NUMBERS | | HYDRAULIC | MECHANICAL | POLE & THROW | NORMAL POSITION | DETAIL | MOUNTING | TERMINALS | NOTES |
|--------------|------------|-----------|------------|--------------|-----------------|---------------------------------|---|---------------|--|
| BULK | BOXED | | | | | | | | |
| 8486 | 8486-BX | | • | SPST | Normally On | - | 2 - Tapped 10-32 mounting holes 5/8" on centers | 2 blade | Lever actuated to Off spring return to On |
| 8486-05 | 8486-05-BX | | | | Normally Off | - | 2 - Tapped 10-32 mounting holes 5/8" on centers | 2 bullet | Lever actuated to On spring return to Off |
| 8626 | 8626-BX | • | | | Normally Off | - | 1/8" -27 thread 11/32" (8.73mm) long | 2 6-32 screw | Operates at 60-120 psi (414-827 kPa); NPTF dry-seal thread for use without sealant |
| 8629 | 8629-BX | • | | | Normally Off | - | 1/8" -27 thread 11/32" (8.73mm) long | 2 male bullet | Operates at 60-120 psi (414-827 kPa); NPTF dry-seal thread for use without sealant |
| 8715 | 8715-BX | | • | | Normally On | Moisture-resistant plastic body | 1/2" Ø 1 5/32" long | 2 blade | Spring return to normal position. |
| 8487 | 8487-BX | | • | | Normally On | Lever is 2 7/8" overall length | Tapped 10-32 mounting holes 5/8" on centers | 2 bullet | Spring return to normal position. |

Neutral Safety Ball Switches

- Spring return to normal position
- Moisture-resistant insulators
- Corrosion-resistant metal housings
- Silver contacts

Additional information: littelfuse.com/NeutralSafetySwitches



| PART NUMBERS | | RATING | POLE & THROW | NORMAL POSITION | MOUNTING | DETAIL | TERMINALS |
|--------------|-------------|--------------------------------|--------------|-----------------|--|--|-----------------|
| BULK | BOXED | | | | | | |
| 9242 | 9242-BX | 35A at 12V DC 20A at 24V DC | SPST | Normally Off | 9/16" -18 UNF-2A thread, 5/16" (7.9mm) long | – | 2 screw |
| 9242-01 | 9242-01-BX | 35A at 12V DC 20A at 24V DC | SPST | Normally Off | 9/16" -18 UNF-2A thread, 5/16" (7.9mm) long | Same as 9242 but with brass gasket/washer | 2 screw |
| 92102 | 92102-BX | 35A at 12V DC 20A at 24V DC | SPST | Normally Off | 9/16" -18 UNF-2A thread, 21/32" (16.7mm) long | Accepts female blade terminals or Delphi 2962679 2-pole connector | 2 button head |
| 92107-04 | 92107-04-BX | 20A at 12V DC | SPST | Normally Off | 3/4" -16 UNF-2A thread, 31/64" (12.3mm) long | – | 2 screw |
| 9162-03 | – | 35A at 12V DC | SPST | Normally Off | 3/4" -16 UNF-2A thread, 31/64" (12.3mm) long | Gasket on mounting stem | 2 female bullet |
| 9224 | 9224-BX | 5A at 12V DC 3A at 24V DC | SPST | Normally On | 3/4" -16 UNF-2A thread, 31/64" (12.3mm) long | Aluminum gasket/washer | 2 screw |
| 9224-07 | 9224-07-BX | 5A at 12V DC | SPST | Normally On | 1/4"-32 thread 1/4" long | – | 2 screw |

Neutral Safety and Backup Lamp Switch Accessories

For Neutral Safety and Back-up Lamp Switches. Molded of durable PVC to resist moisture and dirt. Internal ring forms a seal with the groove around the switch housing.



| PART NUMBERS | | DETAIL | MOUNTING |
|--------------|----------|---|--|
| BULK | BOXED | | |
| 83377 | 83377-BX | Protective boot for switches with 1 1/8" hex housing. Part Numbers: 9224, 9242, 9242-07, 92102, 92103, 92105, 92107-04. | Internal ring forms seal with switch housing groove |

Vehicle Connectors



Heavy duty sockets, plugs and assemblies that withstand the rigors of trucking in dust, dirt, rain and snow, heat and cold, yet maintain electrical continuity between tractor unit and trailer.

Best Practices for Connectors

Properly installed tractor-trailer connectors are critical to the safe performance of a rig so connectors are routinely subjected to vibration, extreme weather conditions, as well as mechanical forces. We highly recommend that a trained technician performs the installation. It is the responsibility of the end-user to take into account the mounting location and environment, conductor type, size, flexibility and other installation parameters.

Review the assembly procedure before assembly. A common error is to not slide a clamp, boot or housing onto the cable before connecting the wires. Recommended tools: screwdriver (preferably with torque limiter); soldering iron (preferably a solder pot), solder and flux; wire stripper and cutter; and ruler. Cut the cable, and strip the jacket to the recommended length. Strip the wires to the recommended length, and tin them. Maintain a tight strand bundle before tinning, so that there are no loose strands. Re-tin if necessary. This makes it easier to insert the wires into the terminal, and helps to properly position the tinned strands at the right depth.

Slide the housing, spring coil or boot over the cable. Properly insert and position the tinned conductor into each terminal. Locate the tinned portion under the terminal screw before tightening the screw. Tighten the termination screws to the appropriate torques.

Inspect the terminated connection for cut or loose strands, fragments of wire insulation between the terminal/conductor connection, bent terminals, loose or stripped terminal screws and other visible problems.

Check that the correct connections have been made, by re-checking that the conductor jacket color matches the insulator coding.

Carefully slide the insulator into the connector housing, making sure that the insulator is fully seated. Don't twist or lever the terminated conductor after it has been inserted and locked into the insulator. This may damage the terminal and put stress on the terminated connection. Finally tighten the housing screw or cable clamp.

In order to keep a plug clean when not inserted in a socket, we recommend the use of the 11750 Stor-A-Way Plug Holder.



12300 & 12301 - 13-Pole Connectors



12300



12301

The 13-pole sockets and plugs provide six additional tractor-trailer circuits within the dimensions of traditional 7-pole connectors. The connectors are adaptable to a wide variety of wiring combinations, including multiplexed circuits. 13-Pole connectors surpass SAE J560b performance standards, by conforming to interchangeability between 7-pole and 13-pole connectors. The connectors are a bright yellow so that the 13 pole configuration is easily identifiable. They are constructed of robust glass-filled plastic housings that cannot rust or corrode. The ground terminals accept up to 8AWG wire, 7 pole terminals up to 10AWG, smaller 6 pole terminals up to 14AWG.

12300, Socket

- Gasket-sealed socket door is spring-loaded and locks onto the plug.
- Rain hood extends beyond the pins to protect the interior. The 5° downward pitch drain channel inside the socket reduces water retention.
- Three mounting holes on the flange: .33" (8.4mm) diameter, 2.93" (74.6mm) on centers.
- Includes six 31784 crimp-on connectors to mate with the six smaller pole terminals.

12301, Plug

- Plug locks into the socket, utilizing the spring-loaded socket door.
- Spring-grip contacts have self-adjusting spring bands to maintain long-term uniform electrical contact with socket pins. They also feature strain relief and grommet seals to isolate the contacts from mechanical strain and provides water protection.
- Cable retainer maintains secure cable connection.
- O-ring at the plug end prevents water from reaching the contacts.
- Includes six 31784 crimp-on connectors to mate with the six smaller pole terminals.

Additional information: littelfuse.com/VehicleConnectors

| PART NUMBERS | | | POLES | TYPE | MATERIAL | COLOR | TERMINALS | | MOUNTING HOLES | NOTES |
|--------------|----------|--------|-------|--------|----------------------|--------|-----------|----------|----------------|--------------------|
| BULK | BOXED | RETAIL | | | | | PIN TYPE | MATERIAL | | |
| 12300 | 12300-BX | – | 13 | Socket | Glass-Filled Plastic | Yellow | Solid | Brass | 3 | Spring Loaded Door |
| 12301 | 12301-BX | – | 13 | Plug | Glass-Filled Plastic | Yellow | Solid | Brass | – | O-ring in plug end |



81356

81356 - Protective Boot for 3-Bolt Flange Sockets

Protect against road splash, dirt and moisture. Fits over the back of the flange, and covers the terminal connectors. Designed for 12310 7-pole socket and 12300 13-pole socket.

| PART NUMBERS | | | POLES | MATERIAL | NOTES |
|--------------|----------|--------|--------|----------|-------------------------------|
| BULK | BOXED | RETAIL | | | |
| 81356 | 81356-BX | – | 7 & 13 | Rubber | Fits Sockets: 12300 and 12310 |

Typical RV 7-Pole Wiring Color Codes

| WIRE COLOR | FUNCTION |
|------------|---------------------------------|
| White | Ground |
| Black | Auxiliary power/battery charge |
| Yellow | Auxiliary |
| Red | Left turn and brake lights |
| Green | Taillights and clearance lights |
| Brown | Right turn and brake lights |
| Blue | Electric trailer brakes |

SAE Coding Convention for 7-Pole Connectors

| WIRE COLOR | CONDUCTOR NUMBER | LITTELFUSE TERMINAL MARKING | FUNCTION |
|------------|------------------|-----------------------------|--|
| White | 1 | W | Ground return to towing vehicle |
| Black | 2 | BK | Clearance, side marker, and identification lamps |
| Yellow | 3 | Y | Left turn signal and hazard lamps |
| Red | 4 | R | Stop lamps and antilock device |
| Green | 5 | G | Right turn signal and hazard lamps |
| Brown | 6 | BR | Tail and license plate lamps |
| Blue | 7 | BL | Continuous ABS power/Auxiliary |

Tractor-Trailer Connectors

7-Pole Connector Sockets

Sockets and plugs conform to ATA, RCCC (RP-102), SAE (J560b), FMVSS-121, FIEI TTMA (RP 40-73) standards or recommendations, and are compatible with other standard (J560b) connectors.

Ground terminal accepts wires up to 8AWG, other terminals up to 10AWG. Solid brass contacts are aligned to assure proper contact and minimal voltage drop. Wiring codes are embossed on the insulator.

The door is spring-loaded and fits over a mating ridge on the socket face to minimize penetration of dirt and moisture. Housings are constructed from corrosion-resistant diecast metal or rugged glass-filled plastic. Contacts are either self-grounding or insulated.

Additional information: littelfuse.com/VehicleConnectors



| PART NUMBERS | | POLES | MOUNTING HOLES | MATERIAL | COLOR | TERMINALS | | DIMENSIONS | | SPRING LOADED DOOR | NOTES | |
|-----------------------|-------------|-------|----------------|----------------------|---------------|-----------|--|--|--|--------------------|------------------------------|---|
| BULK | BOXED | | | | | PIN TYPE | MATERIAL | MOUNTING FLANGE | THROUGH-HOLE | | | |
| 12310 | 12310-BX | 7 | 3 | Glass-Filled Plastic | Black | Solid | Brass | 0.33" (8.4mm) Ø 2.93" (74.6mm) on centers | — | • | Gasket-Sealed with Rain Hood | |
| — | 12080-BX | | | Glass-Filled Plastic | Black | Solid | Brass | 0.488" x 0.328" (12.4x8.3mm) oval 2.93" (74.6mm) on centers | 2" (50.8mm) Ø | • | Insulated | |
| — | 12080-11-BX | | | Glass-Filled Plastic | Green | Solid | Brass | 0.488" x 0.328" (12.4x8.3mm) oval 2.93" (74.6mm) on centers | 2" (50.8mm) Ø | • | Door marked "Trailer ABS" | |
| 12063 | 12063-BX | | 2 | 2 | Diecast Metal | — | Solid | Brass | 0.488" x 0.328" (12.4x8.3mm) oval 2.93" (74.6mm) on centers | 2" (50.8mm) Ø | • | Self-Grounding |
| 12063-11 | — | | | | Diecast Metal | Silver | Solid | Brass | 0.488" x 0.328" (12.4x8.3mm) oval 2.93" (74.6mm) on centers | 2" (50.8mm) Ø | • | — |
| 12063-01 | 12063-01-BX | | | | Diecast Metal | — | Split | Brass | 0.488" x 0.328" (12.4x8.3mm) oval 2.93" (74.6mm) on centers | 2" (50.8mm) Ø | • | Self-Grounding |
| 12077-01 [†] | 12077-01-BX | | | | Diecast Metal | — | 1x Spring Grip Female 6x Solid Male | Brass | 0.488" x 0.328" (12.4x8.3mm) oval 2.93" (74.6mm) on centers | 2" (50.8mm) Ø | • | For ISO-Type Polarized ground terminal - Insulated Mates with 11100-02 and 11100-01 |

[†] Polarized ground terminal, insulated. Replacement for ISO 3731-1976 (E) road vehicles, type 24S (supplementary).

Typical RV 7-Pole Wiring Color Codes

| WIRE COLOR | FUNCTION |
|---------------|---------------------------------|
| White | Ground |
| Black | Auxiliary power/battery charge |
| Yellow | Auxiliary |
| Red | Left turn and brake lights |
| Green | Taillights and clearance lights |
| Brown | Right turn and brake lights |
| Blue | Electric trailer brakes |

SAE Coding Convention for 7-Pole Connectors

| WIRE COLOR | CONDUCTOR NUMBER | LITTELFUSE TERMINAL MARKING | FUNCTION |
|---------------|------------------|-----------------------------|--|
| White | 1 | W | Ground return to towing vehicle |
| Black | 2 | BK | Clearance, side marker, and identification lamps |
| Yellow | 3 | Y | Left turn signal and hazard lamps |
| Red | 4 | R | Stop lamps and antilock device |
| Green | 5 | G | Right turn signal and hazard lamps |
| Brown | 6 | BR | Tail and license plate lamps |
| Blue | 7 | BL | Continuous ABS power/Auxiliary |

7-Pole Connector Plugs – High Performance



12311

Ground terminal accepts wires up to 8AWG, other terminals up to 10AWG. Cable protectors are constructed of plated steel, and provide strain relief and protection against abrasion.

- High-Performance Plug Surpasses SAE J560b performance standards. Superior environmental protection gives extended product life. Black glass-filled plastic housing cannot rust or corrode
- Plug locks onto opening on spring-loaded socket door. Spring-grip contacts have self-adjusting spring bands to maintain long-term uniform electrical contact with socket pins. O-ring at the plug end prevents water from reaching the contacts.
- Strain relief and grommet seal isolates the contacts from mechanical strain, and provides extra moisture protection. Cable retainer maintains secure cable connection. Replaceable interior.
- Connects with all SAE J560b sockets, and Littelfuse brand 13-pole sockets.

Additional information: littelfuse.com/VehicleConnectors

| PART NUMBERS | | POLES | CABLE PROTECTOR | MATERIAL | COLOR | O-RING |
|--------------|----------|-------|-----------------|----------------------|-------|--------|
| BULK | BOXED | | | | | |
| 12311 | 12311-BX | 7 | – | Glass-Filled Plastic | Black | • |

7-Pole Connector Plugs – Quick Release Interiors



12091/12092

Quick Release Plug Interiors can be readily removed by loosening the single set screw in the cable clamp, and then depressing on the spring clip release with a screwdriver. The interior then readily slides out. The interior slides back into the housing and locks securely into place with a high-tension metal clip. After the cable clamp is tightened, the plug is ready for use.

- Plated steel cable protectors are available to provide strain relief and protection against abrasion
- Ground terminal accepts wires up to 8AWG, other terminals up to 10AWG.

Additional information: littelfuse.com/VehicleConnectors



12081/12082

| PART NUMBERS | | | POLES | CABLE PROTECTOR | MATERIAL | COLOR |
|--------------|----------|--------|-------|-----------------|----------------------|-------|
| BULK | BOXED | RETAIL | | | | |
| 12091 | – | – | 7 | – | Diecast Metal | – |
| 12092 | 12092-BX | – | 7 | • | Diecast Metal | – |
| 12081 | – | – | 7 | – | Glass-Filled Plastic | Black |
| 12082 | 12082-BX | – | 7 | • | Glass-Filled Plastic | Black |

7-Pole Connector Plugs – Spring Grip Electrical Contacts



1255

Spring Grip Electrical Contacts contain a self-adjusting spring band that maintains contact pressure from socket to pin. Greater contact pressure not only gives greater electrical efficiency, but also makes coupling and uncoupling uniform, and minimizes buildup of dirt. In competitive plugs, conventional contacts tend to widen after repeated use. These plugs feature individually sprung sockets to insure maximum contact year after year.

- Plated steel cable protectors are available to provide strain relief and protection against abrasion
- Ground terminal accepts wires up to 8AWG, other terminals up to 10AWG
- Diecast metal housing
- Replaceable interior
- Wiring codes are identified on the insulator
- Cable clamp holds all wires securely

Additional information: littelfuse.com/VehicleConnectors

| PART NUMBERS | | | POLES | CABLE PROTECTOR | MATERIAL | COLOR |
|--------------|---------|--------|-------|-----------------|---------------|-------|
| BULK | BOXED | RETAIL | | | | |
| 1222 | 1222-BX | – | 7 | – | Diecast Metal | – |
| 1255 | 1255-BX | – | 7 | • | Diecast Metal | – |

Tractor-Trailer Connectors

4 & 6 Pole Connector Sockets

Normally used with a trailer where limited functionality (taillights, brake lights) is needed. Ideal for boat trailers, or RVs towing a car on a flatbed trailer. Diecast metal housings. Screw terminals accept up to 12AWG wire. Replaceable interiors.

Brass split-pin contacts are aligned to assure proper contact and minimal voltage drop. Spring-loaded socket doors, plug locks securely into the opening. Wiring codes are identified on the insulator. Two mounting holes on the flange 17/64" (6.7mm) diameter, 2 15/16" (74.6mm) on centers. Mount through 1 3/8" (34.9mm) diameter hole.

Additional information: littelfuse.com/VehicleConnectors



1258



1235



1257/1232

| PART NUMBERS | | | POLES | MOUNTING HOLES | MATERIAL | TERMINALS | | DIMENSIONS | | SPRING LOADED DOOR | PROTECTIVE HOUSING | NOTES |
|--------------|---------|--------|-------|----------------|---------------|-----------|----------|---|------------------------|--------------------|--------------------|-------------------------|
| BULK | BOXED | RETAIL | | | | PIN TYPE | MATERIAL | MOUNTING FLANGE | THROUGH-HOLE | | | |
| 1258 | 1258-BX | - | 6 | 2 | Diecast Metal | Split | Brass | 17/67 (6.7mm) Ø 2 15/16" (74.6mm) on centers | 1 3/8" Ø (34.9mm) Ø | • | | Exposed terminal screws |
| 1235 | 1235-BX | - | | 2 | Diecast Metal | Split | Brass | 17/67 (6.7mm) Ø 2 15/16" (74.6mm) on centers | 1 3/8" Ø (34.9mm) Ø | • | • | - |
| 1257 | 1257-BX | - | 4 | 2 | Diecast Metal | Split | Brass | 17/67 (6.7mm) Ø 2 15/16" (74.6mm) on centers | 1 3/8" Ø (34.9mm) Ø | • | | Exposed terminal screws |
| 1232 | 1232-BX | - | | 2 | Diecast Metal | Split | Brass | 17/67 (6.7mm) Ø 2 15/16" (74.6mm) on centers | 1 3/8" Ø (34.9mm) Ø | • | • | - |

4 & 6 Pole Connector Plugs

Contacts float for best alignment and connection. Cable clamps hold all size cables firmly in place. Cable protectors (where present) are constructed from plated steel, and provide strain relief and protection against abrasion.

Additional information: littelfuse.com/VehicleConnectors



1236



1254



1233



1253

| PART NUMBERS | | | POLES | CABLE PROTECTOR | MATERIAL | TERMINALS | | CABLE CLAMPS | NOTES |
|--------------|---------|--------|-------|-----------------|---------------|-----------|----------|--------------|-------------------------|
| BULK | BOXED | RETAIL | | | | PIN TYPE | MATERIAL | | |
| 1236 | 1236-BX | - | 6 | | Diecast Metal | Split | Brass | • | Exposed terminal screws |
| 1254 | 1254-BX | - | | • | Diecast Metal | Split | Brass | • | |
| 1233 | 1233-BX | - | 4 | | Diecast Metal | Split | Brass | • | |
| 1253 | 1253-BX | - | | • | Diecast Metal | Split | Brass | • | Exposed terminal screws |



11041-06

2-Pole Power Take-Off Connectors

Suitable replacement for connectors in tarping applications. Provides a high-integrity two-circuit path for on- and off-road vehicles and in agricultural applications. Plug latches solidly with the socket cover.

- Vertically-aligned machined brass contacts
- Diecast zinc plug and socket housings with engineering-grade plastic interior
- Terminations accept 6AWG wire
- Polarized connections

Additional information: littelfuse.com/VehicleConnectors



11041-05

| PART NUMBERS | | | POLES | CABLE PROTECTOR | MATERIAL | NOTES |
|--------------|-------------|--------|-------|-----------------|---------------|--|
| BULK | BOXED | RETAIL | | | | |
| 11041-06 | 11041-06-BX | – | 2 | – | Diecast Metal | Gasket-sealed socket keeps out dirt and moisture when not in use |
| 11042-05 | 11042-05-BX | – | 2 | • | Diecast Metal | Durable, flexible spring coil protects the cable |



11041

1-Pole Power Take-Off Connectors

Diecast metal plug and socket housings with engineering-grade plastic interior provides power to auxiliary equipment. Electrical conductors and connections are designed for maximum efficiency and long life and terminations accept up to 0AWG wire.

- 11041 - Socket: Self-grounding. Solid brass 3/8" (9.5mm) Ø male contact, with insulated tip to prevent short circuits. Rubber boot protects terminals and connections from moisture and dirt. Fits 2" (50.8mm) Ø hole. Two mounting holes on the flange 21/64" (8.6mm) Ø, 2 15/16" (74.6mm) on centers
- 11042 - Plug: With ground return terminal. Brass female contact with spring grip tension provides solid engagement with the mating socket. Cable clamp holds cable firmly in place.

Additional information: littelfuse.com/VehicleConnectors



11042

| PART NUMBERS | | | POLES | TYPE | MATERIAL | CONTACTS |
|--------------|----------|--------|-------|------|---------------|----------|
| BULK | BOXED | RETAIL | | | | |
| 11042 | 11042-BX | – | 1 | Plug | Diecast Metal | Brass |



1282

Farm Equipment Connectors

Two-pole breakaway unit: plug automatically releases at approximately 20lbs pull. Mate with all connectors of comparable design. Polarized. 20A maximum capacity.

- 1282 - Socket with Mounting Bracket: Plated steel housing. High impact-resistant molded insulator. Brass contacts and brass screw terminals. Stainless steel spring on the cover locks the plug in place. Integral mounting bracket with two .218" (5.6mm) diameter mounting holes, 1.25" (31.8mm) on centers.
- 1283-325, Plug: Plated brass housing. Threaded cable grip.

Additional information: littelfuse.com/VehicleConnectors



1283-325

| PART NUMBERS | | | POLES | TYPE | MATERIAL | CONTACTS | TERMINALS | POLARIZED |
|--------------|-------------|--------|-------|--------|--------------|----------|-------------|-----------|
| BULK | BOXED | RETAIL | | | | | | |
| 1282 | 1282-BX | – | 2 | Socket | Plated Steel | Brass | Brass Screw | • |
| 1283-325 | 1283-325-BX | – | 2 | Plug | Plated Brass | Brass | Brass Screw | • |

In-Line Universal Connector

Flat profile design provides a robust 7-pole or 12-pole connection. Housings are molded thermoplastic material, resistant to ultraviolet solar radiation. Nickel-plated brass terminals with split contact pins give a positive connection. Insulators between each terminal provide protection from short circuits. Spring-loaded socket lid protects the terminals when not in use. Insulated cable clamp secures the cable, minimizing vibration and strain. Terminal covers are easily removed for access to terminals. Additional information: littelfuse.com/VehicleConnectors

- Circuit Identification:**
- | | | |
|----------------------|---|---------------|
| 1. Left turn signal | 5. Accessory | 9. Accessory |
| 2. Accessory | 6. Brake lights | 10. Ground |
| 3. Ground | 7. Rear-clearance and side marker lamps | 11. Accessory |
| 4. Right turn signal | 8. Accessory | 12. Accessory |



| PART NUMBERS | | | POLES | TYPE | MATERIAL | TERMINALS | WIRE SIZE | NOTES |
|--------------|----------|--------|-------|--------|---------------|---------------------|--|----------------------------|
| BULK | BOXED | RETAIL | | | | | | |
| 12400 | 12400-BX | – | 7 | Socket | Thermoplastic | Nickel-Plated Brass | 14AWG Max | – |
| 12401 | 12401-BX | – | | Plug | | | | – |
| 12500 | 12500-BX | – | 12 | Socket | Thermoplastic | Nickel-Plated Brass | Pins 1-7: 14AWG max Pins 8-12: 8AWG max | Accepts 12- or 7-pole plug |
| 12501 | 12501-BX | – | | Plug | | | | – |

Plug & Socket Connectors with Rubber Caps

Polarized to assure proper mating of circuits. Molded insulator bodies. Precision-machined brass contacts. Rubber caps protect connectors. Additional information: littelfuse.com/VehicleConnectors



| PART NUMBERS | | | POLES | TYPE | MATERIAL | CONTACTS | TERMINALS | COLOR | POLARIZED |
|--------------|----------|----------|-------|---------------|---------------|----------|--------------|-------|-----------|
| BULK | BOXED | RETAIL | | | | | | | |
| M-121 | M-121-BX | M-121-BP | 2 | Plug & Socket | Thermoplastic | Brass | Brass Screws | Black | • |
| M-115 | M-115-BX | M-115-BP | 4 | Plug & Socket | Thermoplastic | Brass | Brass Screws | Black | • |

Universal Trailer Connectors

Weatherproof connectors & wire lead assemblies. Polarized to assure proper mating of circuits. Molded bodies. Color-coded 16AWG wire, 6" long (152.4mm). Conductors are properly aligned and bonded into the insulation, to assure minimal voltage drop, and for ease in connecting. Additional information: littelfuse.com/VehicleConnectors



| PART NUMBERS | | | POLES | POLARIZED |
|--------------|----------|----------|-------|-----------|
| BULK | BOXED | RETAIL | | |
| 11134 | 11134-BX | 11134-BP | 4 | • |
| 11173 | 11173-BX | 11173-BP | 3 | • |
| 11172 | 11172-BX | 11172-BP | 2 | • |
| 11172-02 | – | – | 2 | • |
| 11172-03 | – | – | 2 | • |



11750

11750 - Stor-A-Way Plug Holder

Patented by Littelfuse–Cole Hersee. Designed to keep plugs clean when not in use, and extends life by protecting electrical contacts from dirt and roadsplash.

For all SAE J560b 7-pole plugs and 13-pole plugs. Spring-loaded for secure locking.

| PART NUMBERS | | POLES | MATERIAL | NOTES |
|--------------|----------|---------|---------------------------------|---|
| BULK | BOXED | | | |
| 11750 | 11750-BX | 7 or 13 | Heavy duty glass-filled plastic | Fits Plugs: 12311, 1222, 1255, 12091, 12092, 12081, 12082, 12301, 11042 and 11042-05. |
| 11750-03 | – | 7 | Heavy duty glass-filled plastic | Fits Plugs: 12311, 1222, 1255, 12091, 12092, 12081, 12082, 12301, 11042 and 11042-05. |



1160

1160 - License Holder Tube

Weatherproof tube protects important papers. 5" x 1 1/8" (127.0 x 28.6mm).

| PART NUMBERS | | | MATERIAL | | | MOUNTING |
|--------------|-------|--------|----------|---------------|--------|--|
| BULK | BOXED | RETAIL | BODY | CAP | FLANGE | |
| 1160 | – | – | Aluminum | Captive Brass | Brass | Three 3/16" (4.8mm) Ø mounting holes in flange |



81192

81192 - Cable Protector

Protects against strain and kinking.

| PART NUMBERS | | | MATERIAL | NOTES |
|--------------|----------|--------|--------------|--|
| BULK | BOXED | RETAIL | | |
| – | 81192-BX | – | Plated Steel | Fits Plugs: 11042-05, 12081, 12082, 12091, 12092 |



11178

11178 - Protective Boot for 7-Pole Sockets

Protect against road splash, dirt and moisture. Inner ridge locks over the heads of the terminal screws and to the edge of the casting.

| PART NUMBERS | | | POLES | MATERIAL | NOTES |
|--------------|----------|--------|-------|----------|---|
| BULK | BOXED | RETAIL | | | |
| 11178 | 11178-BX | – | 7 | Rubber | Fits Sockets: 12063, 12063-01, 12080, 12080-01, 12080-11, 12077-01 and other 7-pole sockets with similar design |



11165



11164

Surface Mounting Socket Accessories

For attachment of 4-, 6-, and 7-pole sockets of standard design (without integral circuit breakers).

- 11165 - Mounting Bracket: Eliminates the need for cutting a hole in the trailer to accept a socket. Mounting hardware included. Center hole is 2" (50.8mm) diameter.
- 11164 - Mounting Gasket: Neoprene gasket for plastic or metal sockets.

| PART NUMBERS | | | TYPE | MATERIAL | NOTES |
|--------------|----------|--------|---------|----------|--|
| BULK | BOXED | RETAIL | | | |
| 11165 | 11165-BX | – | Bracket | Steel | Mounting hardware included |
| 11164 | 11164-BX | – | Gasket | Neoprene | Fits Sockets: 12063, 12063-01, 12080, 12080-01 |

98647 - 13-Conductor Cable

Straight cable, available in 500' lengths. Conductor wires are color-coded for easy recognition. Durable insulation resists abrasion and will not crack or stiffen at -70°F (-57°C)



98647

| PART NUMBERS | | MATERIAL | 13 TOTAL WIRE CONDUCTOR SIZES | | | |
|--------------|--|-------------|-------------------------------|----------|------------|-----------|
| 500' LENGTH | | | ONE WIRE | ONE WIRE | FIVE WIRES | SIX WIRES |
| 98647 | | 100% Copper | 8AWG | 10AWG | 12AWG | 14AWG |

Indicator Devices



Indicators are used for remote monitoring or indication of system status. Pilot lights are frequently used as signal indicators for accessories or aftermarket add-ons.

What Are the Benefits of LEDs?

LED lights are solid-state, so they last longer and may never need servicing. This means that replacement builds are not needed, and time is saved in applications with maintenance personnel.

LEDs are unaffected by on-off cycling, and their brightness does not diminish over time. LEDs can also function over a wider range of temperatures making them ideal for harsh environments from desert conditions to frigid cold temperatures.

LEDs can be safer because they produce less heat. The build up of heat is undesirable because it can create potential fire risks. LEDs operate at a very cool temperature and the lens is not vulnerable to breakage from water-splash.



12V LED Pilot Lights

Rugged light-emitting diode that ensures long hours of service, never needing bulb replacement. Additional information: littelfuse.com/PilotLights

PL-521 Series • 12V LED Pilot Lights

- Approx. 1" bezel, fits 11/16" diameter hole (17.2mm).



| PART NUMBERS | | | RATING | COLOR | TERMINALS | BEZEL SIZE | HOLE SIZE |
|--------------|--------------|--------|--------|-------|-----------|------------|-----------|
| BULK | BOXED | RETAIL | | | | | |
| PL-521-RC | PL-521-RC-BX | – | 12V DC | Red | ¼" blade | 1" | 11/16" Ø |
| PL-521-AC | PL-521-AC-BX | – | 12V DC | Amber | ¼" blade | 1" | 11/16" Ø |
| PL-521-GC | PL-521-GC-BX | – | 12V DC | Green | ¼" blade | 1" | 11/16" Ø |

PL-522 Series • 12V LED Pilot Lights

- Approx. 3/4" bezel, fits 5/8" diameter hole (15.9mm).



| PART NUMBERS | | | RATING | COLOR | TERMINALS | BEZEL SIZE | HOLE SIZE |
|--------------|--------------|--------|--------|-------|-----------|------------|-----------|
| BULK | BOXED | RETAIL | | | | | |
| PL-522-RC | PL-522-RC-BX | – | 12V DC | Red | ¼" blade | ¾" | 5/8" Ø |
| PL-522-AC | PL-522-AC-BX | – | 12V DC | Amber | ¼" blade | ¾" | 5/8" Ø |
| PL-522-GC | PL-522-GC-BX | – | 12V DC | Green | ¼" blade | ¾" | 5/8" Ø |

PL-523 Series • 12V LED Pilot Lights

- Approx. 3/4" bezel, fits 5/8" diameter hole (15.9mm).



| PART NUMBERS | | | RATING | COLOR | TERMINALS | BEZEL SIZE | HOLE SIZE |
|--------------|--------------|--------|--------|-------|-----------|------------|-----------|
| BULK | BOXED | RETAIL | | | | | |
| PL-523-RC | PL-523-RC-BX | – | 12V DC | Red | ¼" blade | ¾" | 5/8" Ø |
| PL-523-AC | PL-523-AC-BX | – | 12V DC | Amber | ¼" blade | ¾" | 5/8" Ø |
| PL-523-GC | PL-523-GC-BX | – | 12V DC | Green | ¼" blade | ¾" | 5/8" Ø |
| PL-523-BC | PL-523-BC-BX | – | 12V DC | Blue | ¼" blade | ¾" | 5/8" Ø |
| PL-523-CC | PL-523-CC-BX | – | 12V DC | Clear | ¼" blade | ¾" | 5/8" Ø |

PL-524 Series • 12V LED Pilot Lights

- Approx. 5/8" bezel, fits 1/2" diameter hole (15.9mm), 0.5 to 5.5mm thick.



| PART NUMBERS | | | RATING | COLOR | TERMINALS | BEZEL SIZE | HOLE SIZE |
|--------------|--------------|--------|--------|-------|-----------|------------|-----------|
| BULK | BOXED | RETAIL | | | | | |
| PL-524-RC | PL-524-RC-BX | – | 12V DC | Red | ¼" blade | 5/8" | ½" Ø |
| PL-524-AC | PL-524-AC-BX | – | 12V DC | Amber | ¼" blade | 5/8" | ½" Ø |
| PL-524-GC | PL-524-GC-BX | – | 12V DC | Green | ¼" blade | 5/8" | ½" Ø |

PL-525 & PL-526 Series • 12V LED Pilot Lights

- Approx. 3/8" bezel, snaps into 21/64" diameter hole (8.3mm), 0.5 to 2.0mm thick. 6-3/4" wire leads.
- PL-525 series is maintained illuminations; PL-526 series in blinking illumination.



| PART NUMBERS | | | RATING | COLOR | TERMINALS | BEZEL SIZE | HOLE SIZE | BLINKING ILLUMINATION |
|--------------|-------|--------|--------|-------|-----------------|------------|-----------|-----------------------|
| BULK | BOXED | RETAIL | | | | | | |
| PL-525-RC | – | – | 12V DC | Red | 6 ¾" wire leads | 3/8" | 21/64" Ø | |
| PL-525-AC | – | – | 12V DC | Amber | 6 ¾" wire leads | 3/8" | 21/64" Ø | |
| PL-525-GC | – | – | 12V DC | Green | 6 ¾" wire leads | 3/8" | 21/64" Ø | |
| PL-526-RC | – | – | 12V DC | Red | 6 ¾" wire leads | 3/8" | 21/64" Ø | • |
| PL-526-AC | – | – | 12V DC | Amber | 6 ¾" wire leads | 3/8" | 21/64" Ø | • |
| PL-526-GC | – | – | 12V DC | Green | 6 ¾" wire leads | 3/8" | 21/64" Ø | • |

PL-612 & PL-624 Series • 12V & 24V LED Pilot Lights

- 0.63" bezel diameter, fits panels 5.1 to 7.6mm thick. 1.25" (31.7mm) body length.



| PART NUMBERS | | | RATING | COLOR | TERMINALS | BEZEL SIZE | BODY LENGTH |
|--------------|-------------|-------------|--------|-------|-----------|------------|-------------|
| BULK | BOXED | RETAIL | | | | | |
| PL-612-R | PL-612-R-BX | PL-612-R-BP | 12V DC | Red | ¼" blade | 0.63" | 1.25" |
| PL-612-A | PL-612-A-BX | PL-612-A-BP | 12V DC | Amber | ¼" blade | 0.63" | 1.25" |
| PL-612-G | PL-612-G-BX | PL-612-G-BP | 12V DC | Green | ¼" blade | 0.63" | 1.25" |
| PL-612-B | PL-612-B-BX | PL-612-B-BP | 12V DC | Blue | ¼" blade | 0.63" | 1.25" |
| PL-624-R | PL-624-R-BX | – | 24V DC | Red | ¼" blade | 0.63" | 1.25" |
| PL-624-A | PL-624-A-BX | – | 24V DC | Amber | ¼" blade | 0.63" | 1.25" |
| PL-624-G | PL-624-G-BX | – | 24V DC | Green | ¼" blade | 0.63" | 1.25" |
| PL-624-B | PL-624-B-BX | – | 24V DC | Blue | ¼" blade | 0.63" | 1.25" |

Incandescent Pilot Lights

12V Incandescent Pilot Lights

Corrosion-resistant construction. Spring-actuated brass contacts assure proper contact with the bulb. 16AWG (1.0mm²) insulated stranded copper leads, 8" (203mm) long. Additional information: littelfuse.com/PilotLights

PL-2 Series • 12V Single Contact, Insulated Pilot Lights

- #53 bulb supplied, Plated brass bezel, satin finish.
- 5/16" (7.9mm) diameter mounting stem, 3/8" (9.5mm) long.



| PART NUMBERS | | | RATING | LENS COLOR | TERMINALS | BEZEL SIZE | LENS SIZE |
|--------------|---------------|--------|--------|------------|------------------|---------------|------------------|
| BULK | BOXED | RETAIL | | | | | |
| – | PL-2-RC000-BX | – | 12V DC | Red | 2x 8" wire leads | ½" (12.7mm) Ø | 3/16" (4.76mm) Ø |
| PL-2-GC000 | PL-2-GC000-BX | – | 12V DC | Green | 2x 8" wire leads | ½" (12.7mm) Ø | 3/16" (4.76mm) Ø |
| PL-2-BC000 | – | – | 12V DC | Blue | 2x 8" wire leads | ½" (12.7mm) Ø | 3/16" (4.76mm) Ø |

PL-20 Series • 12V Single Contact, Insulated Pilot Lights

- #53 bulb supplied, Chrome-plated brass bezel.
- 3/4" (19.1mm) diameter mounting stem, 11/16" (17.5mm) long.



| PART NUMBERS | | | RATING | LENS COLOR | TERMINALS | BEZEL SIZE | LENS SIZE |
|--------------|----------------|--------|--------|------------|------------------|-----------------|-------------------|
| BULK | BOXED | RETAIL | | | | | |
| PL-20-RC000 | PL-20-RC000-BX | – | 12V DC | Red | 2x 8" wire leads | 7/8" (22.2mm) Ø | 17/32" (13.5mm) Ø |
| PL-20-GC000 | PL-20-GC000-BX | – | 12V DC | Green | 2x 8" wire leads | 7/8" (22.2mm) Ø | 17/32" (13.5mm) Ø |
| PL-20-AC000 | PL-20-AC000-BX | – | 12V DC | Amber | 2x 8" wire leads | 7/8" (22.2mm) Ø | 17/32" (13.5mm) Ø |

PL-36 Series • 12V Single Contact, Insulated with Faceted Lens Pilot Lights

- Lenses have honeycomb pattern on the internal side, smooth on the outside.
- #53 bulb supplied, Satin finish stainless steel bezel.
- 1/2" (12.7mm) diameter mounting stem, 3/8" (9.5mm) long.



| PART NUMBERS | | | RATING | COLOR | TERMINALS | BEZEL SIZE | LENS SIZE |
|--------------|----------------|--------|--------|-------|------------------|---------------|-----------------|
| BULK | BOXED | RETAIL | | | | | |
| PL-36-RC000 | PL-36-RC000-BX | – | 12V DC | Red | 2x 8" wire leads | ¾" (19.1mm) Ø | 5/16" (8.0mm) Ø |
| PL-36-GC000 | PL-36-GC000-BX | – | 12V DC | Green | 2x 8" wire leads | ¾" (19.1mm) Ø | 5/16" (8.0mm) Ø |
| – | PL-36-AC000-BX | – | 12V DC | Amber | 2x 8" wire leads | ¾" (19.1mm) Ø | 5/16" (8.0mm) Ø |

PL-85 Series • 12V Single Contact with Faceted Lens

- #67 bulb supplied, Plated brass bezel.
- 7/8" (22.2mm) diameter mounting stem, ¾" (19.1mm) long.
- Faceted outer lens surface.
- Gasket sealed.



| PART NUMBERS | | | RATING | LENS COLOR | TERMINALS | BEZEL SIZE | LENS SIZE |
|--------------|----------------|--------|--------|------------|------------------|----------------|-------------------|
| BULK | BOXED | RETAIL | | | | | |
| PL-85-RC000 | PL-85-RC000-BX | – | 12V DC | Red | 1x 8" wire leads | 1¼" (31.8mm) Ø | 15/16" (23.8mm) Ø |
| PL-85-GC000 | PL-85-GC000-BX | – | 12V DC | Green | 1x 8" wire leads | 1¼" (31.8mm) Ø | 15/16" (23.8mm) Ø |
| PL-85-AC000 | PL-85-AC000-BX | – | 12V DC | Amber | 1x 8" wire leads | 1¼" (31.8mm) Ø | 15/16" (23.8mm) Ø |

PL-86 Series • 12V Double Contact, Insulated

- #68 bulb supplied, Plated brass bezel.
- 7/8" (22.2mm) diameter mounting stem, ¾" (19.1mm) long.
- Gasket sealed.



| PART NUMBERS | | | RATING | LENS COLOR | TERMINALS | BEZEL SIZE | LENS SIZE |
|--------------|----------------|--------|--------|------------|------------------|----------------|-------------------|
| BULK | BOXED | RETAIL | | | | | |
| PL-86-RC000 | PL-86-RC000-BX | – | 12V DC | Red | 2x 8" wire leads | 1¼" (31.8mm) Ø | 15/16" (23.8mm) Ø |
| PL-86-GC000 | PL-86-GC000-BX | – | 12V DC | Green | 2x 8" wire leads | 1¼" (31.8mm) Ø | 15/16" (23.8mm) Ø |
| PL-86-AC000 | PL-86-AC000-BX | – | 12V DC | Amber | 2x 8" wire leads | 1¼" (31.8mm) Ø | 15/16" (23.8mm) Ø |

Incandescent Pilot Lights



PL-116 Series • 12V Single Contact, Insulated Pilot Light

- #1893 bulb supplied, Aluminum bezel
- Plastic socket

| PART NUMBERS | | | RATING | LENS COLOR | TERMINALS | BEZEL SIZE | LENS SIZE |
|--------------|-----------------|--------|--------|------------|-----------|-------------------|-----------------|
| BULK | BOXED | RETAIL | | | | | |
| – | PL-116-RC000-BX | – | 12V DC | Red | None | 15/16" (23.8mm) Ø | 5/8" (15.9mm) Ø |



PL-118 Series • 12V Single Contact, Insulated Pilot Lights

- Mounts through rear of the panel. #1893 bulb supplied. Satin finish or black aluminum bezel.
- 11/16" (7.5mm) diameter mounting stem, 1/4" (6.4mm) long.

| PART NUMBERS | | | RATING | LENS COLOR | BEZEL COLOR | TERMINALS | BEZEL SIZE | LENS SIZE |
|--------------|-----------------|--------|--------|------------|--------------|------------------|-------------------|-----------------|
| BULK | BOXED | RETAIL | | | | | | |
| PL-118-RC000 | PL-118-RC000-BX | – | 12V DC | Red | Satin Silver | 2x 8" wire leads | 15/16" (23.8mm) Ø | 5/8" (15.9mm) Ø |
| PL-118-RC001 | PL-118-RC001-BX | – | 12V DC | Red | Black | 2x 8" wire leads | 15/16" (23.8mm) Ø | 5/8" (15.9mm) Ø |
| PL-118-GC001 | PL-118-GC001-BX | – | 12V DC | Green | Black | 2x 8" wire leads | 15/16" (23.8mm) Ø | 5/8" (15.9mm) Ø |
| PL-118-AC001 | – | – | 12V DC | Amber | Black | 2x 8" wire leads | 15/16" (23.8mm) Ø | 5/8" (15.9mm) Ø |



M-320 Series • 12V Single Contact, Insulated with Smooth Lens

- #53 bulb supplied, Chrome-plated brass bezel
- Plastic socket
- 3/4" (19.1mm) diameter mounting stem, 1 1/16" (27.0mm) long.

| PART NUMBERS | | | RATING | LENS COLOR | TERMINALS | BEZEL SIZE | LENS SIZE |
|--------------|----------------|--------|--------|------------|------------------|-----------------|-------------------|
| BULK | BOXED | RETAIL | | | | | |
| – | M-320-RC000-BX | – | 12V DC | Red | 2x 8" wire leads | 7/8" (22.2mm) Ø | 17/32" (13.5mm) Ø |

Panel Lamps and Base Sockets

12V Bayonet Base Sockets

- Accept incandescent or LED bulbs with corresponding bases.
- Suggested lamp numbers for BA15s sockets: 63, 67, 81, 87, 93, 97,103, 209,1073, 1129, 1133, 1141, 1156.
- 16AWG insulated stranded copper leads 8" (203mm) long



26145



26100



2609



3575



2611

| PART NUMBERS | | | RATING | LAMPS ACCEPTED | MOUNTING | TERMINALS | CONTACT TYPE | NOTES |
|--------------|----------|----------|--------|----------------|--|-----------|--------------|--|
| BULK | BOXED | RETAIL | | | | | | |
| – | – | 26100-BP | 12V DC | BA15d | Without Flange | 2x Wire | Double | 11/16" outside diameter Molded plastic insulator |
| 2609 | 2609-BX | – | | | Side bracket with 3/16" (4.8mm) Ø hole | 1x Wire | Single | – |
| M-432 | M-432-BX | M-432-BP | | | Standard Base | 2 Screw | Double | Marine Socket |
| M-458 | M-458-BX | – | | | Standard Base | 2 Wire | Double | Marine Dash Assembly |



DL Series • 12V Single Contact, Grounding Panel Lamps

- Self-grounding to metal panels
- For illumination of maps or other items, with minimal interference of driving visibility
- Hood can be rotated to direct the light beam
- 11/16" (17.5mm) diameter mounting stem, 3/8" (9.5mm) long; mount through the panel.
- 16AWG insulated stranded copper leads



| PART NUMBERS | | | RATING | COLOR | MATERIAL | TERMINALS |
|--------------|----------|--------|--------|---------------|----------|------------------|
| BULK | BOXED | RETAIL | | | | |
| DL-13 | DL-13-BX | – | 12V DC | Chrome-plated | Brass | 1x 8" wire leads |
| DL-21 | DL-21-BX | – | 12V DC | Black | Steel | 1x 8" wire leads |

Buzzers and Alarms



4099 • 12 & 24V DC Universal Buzzer

Hundreds of uses; for 'door ajar' warning, bus driver alert, low air pressure, temperature, etc. Works with any temperature, pressure, door or momentary switch. Electrical contacts are designed for instant response and uninterrupted signal.

- Impact resistant ABS resin case
- Moisture repellent insulator

Additional information: littelfuse.com/Alarms

| PART NUMBERS | | | VOLTAGE | DIMENSIONS | TERMINALS |
|--------------|----------|---------|---------|---|-----------|
| BULK | BOXED | RETAIL | | | |
| 4099 | 4099-BX | 4099-BP | 12V DC | 1 7/8" x 2 1/2" x 2 17/32" (30.9 x 63.2 x 64.3mm) | 2 Screw |
| 40151 | 40151-BX | — | 24V DC | | |

40100 • Buzzer Pull Switch



For use by passengers in buses and rapid transit vehicles, the end of the switch attaches to a cord. Use with Littelfuse buzzers or buzzer/flashers: 4099, 4112 RC, 4124-RD.

SPST Off-Mom. On. Normally Off, pull to On, spring return to Off. Neutral gray enamel finish cover. Operates with a pull cord.

Additional information: littelfuse.com/Alarms

| PART NUMBERS | | | VOLTAGE | TERMINALS |
|--------------|----------|--------|--------------|-----------|
| BULK | BOXED | RETAIL | | |
| 40100 | 40100-BX | — | Up to 36V DC | 2 Screw |



4112-RC • 12 & 24V DC Buzzer and LED Indicator "Dual Alarm"

Rugged combination warning light and buzzer gives audible and visible alert. Device is a universal application and can be used with any electrical switch. Red lens, long-life LED. 11/16" (17.46mm) diameter mounting stem, 17/32" (13.88mm) long.

Additional information: littelfuse.com/Alarms

| PART NUMBERS | | | VOLTAGE | DIMENSIONS | TERMINALS |
|--------------|---------------|------------|---------|---|-----------|
| BULK | BOXED | RETAIL | | | |
| 4112-RC000 | 4112-RC000-BX | 4112-RC-BP | 12V DC | 1 7/8" x 1" x 1 11/32" (47.6 x 25.4 x 34.1mm) | 2 Screw |

40212 • 12V DC Dual Rate Electronic Alarm

Utilizes advanced integrated circuit surface mount technology. Negative ground. Use with two input sources to warn of two different hazardous conditions. Sounds at two different rates: one sensor triggers a fast-rate alarm, the second actuates a slower rate alarm tone.

- Minimum sound level: 90dB
- Lightweight molded plastic housing
- Solid-state circuitry
- Plugs into Littelfuse connector 3032 or 3029, Delphi (Packard) 12033871, or accepts connectors for 1/4" (6.4mm) blades

Additional information: littelfuse.com/Alarms



| PART NUMBERS | | | VOLTAGE | DIMENSIONS | TERMINALS | NOTES |
|--------------|----------|--------|---------|---|-------------|---------------------------|
| BULK | BOXED | RETAIL | | | | |
| 40212 | 40212-BX | — | 12V DC | 2.005" x 1.185" x .930" (50.4 x 30.3 x 23.66mm) | 1/4" Blades | Minimum sound level: 90dB |



Why Are LED Lights Better For My Vehicle?

THEY ARE SOLID-STATE, SO THEY LAST LONGER, AND MAY NEVER NEED REPLACING

You don't need to purchase replacement bulbs and keep a stock of them. You won't need to use the valuable time of your maintenance staff. Less downtime for your vehicles means more revenue-producing hours per vehicle. LEDs are unaffected by the on-off cycling. Their brightness doesn't diminish over time. LEDs can function over a wider range of temperatures, from desert conditions to frigid weather.

LEDs LAST LONGER BECAUSE THEY ARE UNAFFECTED BY VIBRATION

Incandescent bulbs contain a small filament which is vulnerable to the shock experienced by vehicles as they travel. LEDs are solid state and don't have filaments or bulbs that can work loose.

LEDs PRODUCE LESS HEAT

LEDs are safer. A buildup of heat is undesirable since the potential exists to cause fires. LEDs run far cooler. The heated glass of conventional bulbs is vulnerable to splash – and more likely to fail prematurely.

LEDs ARE MORE EFFICIENT

Less battery drain. Up to 90% of the power used in an incandescent bulb is converted into wasted heat energy. For the amount of light emitted, LEDs draw fewer watts from your batteries. LEDs are not susceptible to the corrosion that may occur in bulb bases and sockets.



PL-85 Series



PL-118 Series



M-320 Series



PL-2 Series



PL-612 Series

Alphanumeric Part Number Index

Use index as a quick resource to find the page number of a specific part you are looking for.

Cole Hersee Packaging

Retail packaging products are designated by the BP and BX suffixes.



BX and **BP** suffixes are not individually listed, but represented by their bulk part number.

Example:

Retail packaging toggle switch 5558-BP will be listed as 5558

5558-BP

"Bulk Part Number" "Blister Pack"

Littelfuse Packaging

Order numbers must have between 9 characters and 15 characters.



NOTE:

Products with the amperage used in their part number are not individually listed.

Example:

10 Amp ATO Fuse, 0ATO010.VP = 0ATO0xx.VP

0ATO 010.VP

First set of four
"ATO Fuses"

Second set of four
"10 Amps"

"Retail pack
of 5"

0MIN 030.ZXPRO

First set of four
"MINI Fuses"

Second set of four
"30 Amps"

"Plus Pack"

Inner Pack Codes - Quantity Code

| | | | |
|--------|---------|-----------|------------|
| 1 = X | 50 = L | 500 = U | 3,000 = W |
| 5 = V | 100 = H | 1,000 = M | 4,000 = Y |
| 10 = T | 200 = F | 1,500 = D | 5,000 = N |
| 20 = S | 250 = G | 2,500 = E | 10,000 = K |

| Part Number | Page | Part Number | Page | Part Number | Page | Part Number | Page | Part Number | Page |
|---------------|------|----------------|------|---------------|------|----------------|------|-----------------|------|
| 00940133ZP | 21 | 00940402ZP | 20 | 00940550Z | 21 | 00940570ZXA | 23 | 02981001ZXT | 32 |
| 00940134ZP | 21 | 00940408ZP | 21 | 00940551Z | 23 | 00970019X | 37 | 02981028HXFC | 32 |
| 00940135ZP | 21 | 00940409Z | 23 | 00940552Z | 23 | 00970019XP | 37 | 02981028HXFC-SS | 32 |
| 00940154ZP | 21 | 00940413ZP | 20 | 00940553Z | 23 | 00970023XP | 37 | 0327xxx.LXS | 15 |
| 00940189ZP | 21 | 00940418ZP | 22 | 00940554Z | 21 | 00970025XPA | 37 | 0337xxx.LXS | 15 |
| 00940202ZP | 21 | 00940419ZP | 22 | 00940555ZPGLO | 21 | 00970026XP | 37 | 03453LF2XP | 35 |
| 00940202ZPGLO | 21 | 00940422Z | 23 | 00940556ZPGLO | 21 | 00970038XPA | 37 | 03500417TXN | 39 |
| 00940301ZP | 21 | 00940441ZP | 22 | 00940557ZXA | 21 | 00970053XP | 37 | 03500417XP | 39 |
| 00940362ZP | 21 | 00940442ZP | 22 | 00940558ZPA | 21 | 00970054XPA | 37 | 03500418TXN | 39 |
| 00940362ZPGLO | 21 | 00940461ZP | 22 | 00940559ZPA | 21 | 01520003TXN941 | 33 | 03500418XP | 39 |
| 00940363ZP | 22 | 00940462Z | 21 | 00940560ZXA | 23 | 01520003TXN942 | 33 | 03540801ZXGY | 39 |
| 00940365ZP | 22 | 00940462ZGLO | 21 | 00940561ZPA | 22 | 01520005Z | 33 | 03540802ZXGY | 39 |
| 00940366ZP | 22 | 00940475Z | 21 | 00940562ZPA | 22 | 01520006Z | 33 | 03540804ZXGY | 39 |
| 00940367ZP | 22 | 00940477Z | 10 | 00940563ZPA | 22 | 01550300Z | 34 | 03560001Z | 39 |
| 00940368ZP | 22 | 00940478Z | 10 | 00940565ZPA | 22 | 0185xxx.X | 30 | 03560002Z | 39 |
| 00940369ZP | 22 | 00940479ZP | 22 | 00940565ZXA | 23 | 0185xxx.XP | 30 | 03560004Z | 39 |
| 00940370ZP | 22 | 00940480Z | 23 | 00940566ZPA | 22 | 0211xxx.XP | 30 | 03560006Z | 39 |
| 00940396Z | 24 | 00940506ZP | 21 | 00940566ZXA | 21 | 02980900S | 32 | 04980900S | 33 |
| 00940400Z | 21 | 00940509ZXGLOA | 24 | 00940567ZPA | 22 | 02980900TXN | 32 | 04980900ZXT | 33 |
| 00940400ZGLO | 21 | 00940510ZXGLOA | 24 | 00940569ZPA | 22 | 02980900Z | 32 | 04980903ZXT | 33 |

Alphanumeric Part Number Index

| Part Number | Page | Part Number | Page | Part Number | Page | Part Number | Page | Part Number | Page |
|---------------|------|---------------|------|---------------|------|-------------|------|-------------|------|
| 04980904ZXT | 33 | 0AGWxxx.V | 19 | 0MAB0001XP | 33 | 1257 | 115 | 5592 | 89 |
| 04980921GXM5 | 33 | 0AGWxxx.VP | 19 | 0MAXxxx.X | 14 | 1258 | 115 | 7112 | 103 |
| 04980932.X | 46 | 0AGX0002ZP | 21 | 0MAXxxx.XP | 14 | 1282 | 116 | 7124 | 103 |
| 04980932ZXT | 46 | 0AGXxxx.VP | 19 | 0MAXxxx.XPGLO | 14 | 1283-325 | 116 | 7124-06 | 103 |
| 04980933.X | 46 | 0ATD0300ZBP | 37 | 0MCBxxx.X | 28 | 2484 | 66 | 7127 | 103 |
| 04980933ZXT | 46 | 0ATOxxx.V | 14 | 0MEGxxx.L | 17 | 2484-02 | 66 | 7152 | 103 |
| 04981038HXFC | 32 | 0ATOxxx.VP | 14 | 0MEGxxx.X | 17 | 2484-03 | 66 | 7157 | 103 |
| 04982001ZXFC | 32 | 0ATOxxx.VPGLO | 14 | 0MEGxxx.XP | 17 | 2484-06 | 66 | 7493 | 104 |
| 0498900.TXN | 33 | 0ATOxxx.ZXPRO | 14 | 0MIDxxx.X | 17 | 2484-09 | 66 | 7493-07 | 104 |
| 0498xxx.TXN | 17 | 0BPF0001ZP | 36 | 0MIDxxx.XP | 17 | 2484-16 | 66 | 7700 | 108 |
| 0695xxx.LPXP | 16 | 0CCBxxx.X | 27 | 0MINxxx.V | 13 | 2484-19 | 66 | 7762 | 108 |
| 0695xxx.LPXPS | 16 | 0CCBxxx.XP | 27 | 0MINxxx.VP | 13 | 2484-A | 66 | 7784 | 108 |
| 0695xxx.U | 16 | 0CNLxxx.V | 20 | 0MINxxx.VPGLO | 13 | 2609 | 122 | 7785-01 | 108 |
| 0695xxx.US | 16 | 0CNNxxx.V | 20 | 0MINxxx.ZXPRO | 13 | 3031-0 | 35 | 7786 | 108 |
| 07981002ZXS | 45 | 0CNNxxxE.V | 20 | 0MMBxxx.X | 27 | 3031-20 | 35 | 7786-01 | 108 |
| 08010100 | 64 | 0FCBxxx.X | 27 | 0MNBxxx.X | 27 | 3031-30 | 35 | 7786-03 | 108 |
| 08010200 | 64 | 0FCBxxx.XP | 27 | 0MRS0001Z | 26 | 3088-50 | 29 | 7787 | 108 |
| 08070900 | 54 | 0FHA0001SXJ | 34 | 0MRS0002Z | 26 | 3088-60 | 29 | 7789-02 | 108 |
| 08080200 | 63 | 0FHA0001XP | 34 | 0MRS0003Z | 26 | 3088-80 | 29 | 7792 | 107 |
| 08081400 | 63 | 0FHA0001XPGLO | 34 | 0MRS0004Z | 26 | 407-01 | 99 | 7792-01 | 107 |
| 08084300 | 65 | 0FHA0002SXJ | 34 | 0MRS0005Z | 26 | 407-02 | 99 | 7792-03 | 107 |
| 08084400 | 65 | 0FHA0002XP | 34 | 0MRS0006Z | 26 | 407-03 | 99 | 876-199 | 38 |
| 08098700 | 63 | 0FHA0030XP | 34 | 0MRS0007Z | 26 | 4099 | 123 | 882-267-002 | 32 |
| 08098780 | 63 | 0FHA0200Z | 36 | 0MRS0007ZXA | 26 | 4112-RC000 | 123 | 882-267-003 | 32 |
| 08098800 | 64 | 0FHA0200ZP | 36 | 0MRS0009ZXA | 26 | 4721-P10 | 40 | 882-267-004 | 32 |
| 08098881 | 64 | 0FHJ1001G | 35 | 0MRS0200Z | 26 | 4721-P12 | 40 | 882-267-005 | 32 |
| 08098882 | 64 | 0FHJ1002G | 35 | 0MRS0300Z | 26 | 4721-P14 | 40 | 882-839-2 | 32 |
| 08098900 | 65 | 0FHJ2001G | 35 | 0MXBxxx.X | 28 | 4721-P2 | 40 | 882-839-3 | 32 |
| 08098980 | 65 | 0FHJ2002G | 35 | 0OMN0xxxXP | 39 | 4721-P3 | 40 | 882-839-4 | 32 |
| 08098981 | 65 | 0FHM0001SXJ | 34 | 0PALxxx.X | 18 | 4721-P4 | 40 | 882-839-5 | 32 |
| 08099080 | 63 | 0FHM0001XP | 34 | 0PALxxx.XP | 18 | 4721-P5 | 40 | 882-853 | 38 |
| 0812xxx.ZXST | 29 | 0FHM0001XPGLO | 34 | 0RBOX001Z | 25 | 4721-P6 | 40 | 882-854 | 38 |
| 0813xxx.XP | 29 | 0FHM0002SXJ | 34 | 0RBOX002Z | 25 | 4721-P8 | 40 | 8250 | 92 |
| 0813xxx.ZXST | 29 | 0FHM0002XP | 34 | 0RBOX003Z | 25 | 4755 | 40 | 8367 | 77 |
| 0ACBxxx.XP | 27 | 0FHM0200Z | 36 | 0RBOX004Z | 25 | 4758 | 40 | 8486 | 109 |
| 0AFH0001XP | 34 | 0FHM0200ZP | 36 | 0RBOX005Z | 25 | 5007 | 102 | 8486-05 | 109 |
| 0AFH0001Z | 34 | 0FHP0001Z | 35 | 0RBOX006Z | 25 | 5011 | 102 | 8487 | 109 |
| 0AFH0002XP | 34 | 0FHZ0001Z | 47 | 0RED0BOXZ | 25 | 5050 | 102 | 8626 | 109 |
| 0AGA0001ZP | 21 | 0FHZ0002Z | 47 | 0RED0BOXZXNG | 25 | 5507 | 90 | 8629 | 109 |
| 0AGA0002ZP | 21 | 0FHZ0003Z | 47 | 0RED0BOXZXNGA | 25 | 5520 | 89 | 8715 | 109 |
| 0AGA0003ZP | 21 | 0FHZ0005Z | 47 | 0SFE0001ZP | 21 | 5543 | 92 | 901-325 | 38 |
| 0AGAxxx.V | 19 | 0FHZ00853-BX | 38 | 0SFE0001ZPGLO | 21 | 5543-09 | 92 | 956-3122 | 73 |
| 0AGAxxx.VP | 19 | 0FHZ00854-BX | 38 | 0SFExxx.V | 19 | 5543-15 | 92 | 956-3124 | 73 |
| 0AGC0001ZP | 21 | 0FHZ0201Z | 38 | 0SFExxx.VP | 19 | 5558 | 90 | 956-3125 | 73 |
| 0AGC0001ZPGLO | 21 | 0FHZ0202Z | 38 | 0UCBxxx.X | 28 | 5568 | 90 | 956-3126 | 73 |
| 0AGC0002ZP | 21 | 0FHZ0211Z | 38 | 0UCBxxx.XP | 28 | 5570 | 90 | 956-3127 | 73 |
| 0AGC0003ZP | 21 | 0FHZ0212Z | 38 | 1160 | 118 | 5582 | 89 | 956-3135 | 73 |
| 0AGC0004ZP | 21 | 0FLC014.XP | 20 | 1222 | 114 | 5582-10 | 89 | 956-4100 | 73 |
| 0AGC0005ZP | 21 | 0FLW014.XP | 20 | 1232 | 115 | 5582-30-BP | 89 | 956-4107 | 73 |
| 0AGCxxx.VP | 19 | 0FLW016.XP | 20 | 1233 | 115 | 5582-36 | 89 | 956-4111-BX | 73 |
| 0AGCxxxV | 19 | 0FNY0xxxXP | 35 | 1235 | 115 | 5584 | 89 | 956-4113 | 73 |
| 0AGUxxx.T | 19 | 0GBCxxx.V | 19 | 1236 | 115 | 5584-15 | 89 | 956-4124 | 73 |
| 0AGUxxx.VPG | 19 | 0GBCxxx.VP | 19 | 1253 | 115 | 5586 | 89 | 956-4138 | 73 |
| 0AGW0001ZP | 21 | 0MAB0001F | 33 | 1254 | 115 | 5588 | 89 | 956-4141 | 73 |
| 0AGW0002ZP | 21 | 0MAB0001S | 33 | 1255 | 114 | 5590 | 89 | 956-4154 | 73 |

Alphanumeric Part Number Index

| Part Number | Page | Part Number | Page | Part Number | Page | Part Number | Page | Part Number | Page |
|-------------|------|-------------|------|-------------|------|-------------|------|-------------|------|
| 956-4307 | 73 | 9513 | 74 | 24214 | 55 | 55023 | 89 | 92102 | 110 |
| 956-4311 | 73 | 9576 | 103 | 24401 | 57 | 55025 | 88 | 92116 | 97 |
| 956-5109 | 73 | 9577 | 74 | 24402 | 57 | 55036 | 89 | 95033 | 75 |
| 956-5124 | 73 | 9578 | 74 | 24450 | 58 | 55046 | 89 | 95060 | 72 |
| 956-5307 | 73 | 9579 | 74 | 24452 | 58 | 55054 | 89 | 95410 | 77 |
| 956-6307 | 73 | 9579-02 | 74 | 24505 | 70 | 55055 | 89 | 95535 | 74 |
| 956-6310 | 73 | 9622-01 | 75 | 24612 | 57 | 55064 | 92 | 95539 | 74 |
| 956-9100 | 73 | 11042 | 116 | 24812 | 57 | 55071 | 92 | 95582 | 74 |
| 9001 | 99 | 11134 | 117 | 24848 | 57 | 55088 | 89 | 95591 | 75 |
| 9002-BX | 99 | 11164 | 118 | 31101 | 77 | 55093 | 92 | 95593 | 74 |
| 9003 | 100 | 11165 | 118 | 40100 | 123 | 58336 | 80 | 95597 | 75 |
| 9011 | 103 | 11172 | 117 | 40151 | 123 | 58337 | 80 | 95610 | 75 |
| 9023 | 97 | 11173 | 117 | 40212 | 123 | 59071 | 92 | 95612 | 75 |
| 9044-BX | 97 | 11178 | 118 | 48051 | 50 | 68028 | 103 | 96101 | 97 |
| 9050-01 | 99 | 11750 | 118 | 48070 | 50 | 68362 | 104 | 98628 | 84 |
| 9052 | 109 | 12063 | 113 | 48090 | 50 | 71092 | 103 | 98647 | 118 |
| 9055 | 100 | 12081 | 114 | 48120 | 50 | 72100 | 103 | 99025 | 60 |
| 9055-08 | 100 | 12082 | 114 | 48122 | 50 | 74603 | 107 | 99026 | 60 |
| 9060 | 108 | 12091 | 114 | 48160 | 50 | 75125 | 109 | 551802 | 90 |
| 9075 | 98 | 12092 | 114 | 48161 | 50 | 75226 | 106 | 551840 | 90 |
| 9087-BX | 99 | 12300 | 112 | 48162 | 50 | 75236 | 106 | 551841 | 90 |
| 9095 | 96 | 12301 | 112 | 48525 | 50 | 75600 | 105 | 551842 | 90 |
| 9100 | 96 | 12310 | 113 | 48530 | 50 | 75701 | 104 | 551844 | 90 |
| 9109 | 97 | 12311 | 114 | 48540 | 51 | 75903 | 67 | 551849 | 90 |
| 9115 | 97 | 12400 | 117 | 48610 | 51 | 75904 | 67 | 880014 | 32 |
| 9118 | 100 | 12401 | 117 | 48710 | 51 | 75907 | 67 | 880015 | 32 |
| 9118-04 | 100 | 12500 | 117 | 48785 | 54 | 75908 | 66 | 880062 | 62 |
| 9162-03 | 110 | 12501 | 117 | 50001 | 102 | 75912 | 67 | 880064 | 62 |
| 9165 | 97 | 12804 | 51 | 50002 | 102 | 75920 | 62 | 880073 | 46 |
| 9180 | 100 | 12805 | 51 | 50036 | 103 | 81255 | 92 | 880076 | 45 |
| 9183 | 108 | 24008 | 56 | 50046 | 102 | 81264 | 92 | 880086 | 54 |
| 9187 | 98 | 24021 | 56 | 50066 | 102 | 81356 | 112 | 880088 | 54 |
| 9187-02 | 98 | 24022 | 56 | 50070 | 102 | 82065 | 70 | 880089 | 46 |
| 9211 | 97 | 24023 | 56 | 50082 | 102 | 82468 | 92 | 880094 | 46 |
| 9212 | 97 | 24024 | 66 | 50088 | 102 | 83274 | 77 | 880107 | 54 |
| 9216 | 96 | 24037 | 56 | 50203 | 103 | 83280 | 99 | 880154 | 62 |
| 9216-03 | 96 | 24044 | 56 | 54003 | 84 | 83353 | 70 | 880175 | 62 |
| 9216-10 | 96 | 24047 | 56 | 54007 | 84 | 83357 | 77 | 11041-06 | 116 |
| 9224 | 110 | 24054 | 104 | 54010 | 84 | 83377 | 110 | 11042-05 | 116 |
| 9224-07 | 110 | 24059 | 55 | 54012 | 84 | 83379 | 77 | 11172-02 | 117 |
| 9231 | 96 | 24060 | 56 | 54100 | 88 | 90002 | 97 | 11172-03 | 117 |
| 9238 | 97 | 24063 | 55 | 54103 | 88 | 90018 | 96 | 11750-03 | 118 |
| 9238-07 | 96 | 24071 | 56 | 54104 | 88 | 90030 | 96 | 12063-01 | 113 |
| 9242 | 110 | 24076 | 56 | 54109 | 88 | 90043 | 97 | 12063-11 | 113 |
| 9242-01 | 110 | 24080 | 55 | 54110 | 88 | 90047 | 98 | 12077-01 | 113 |
| 9245 | 96 | 24082 | 55 | 55013 | 90 | 90048 | 98 | 12077-01-BX | 113 |
| 9264 | 100 | 24097 | 55 | 55014 | 89 | 91001 | 108 | 12080-11-BX | 113 |
| 9264-02 | 100 | 24103 | 56 | 55015 | 89 | 91050 | 99 | 12080-BX | 113 |
| 9264-04 | 100 | 24106 | 55 | 55016 | 89 | 91105 | 109 | 24008-03 | 56 |
| 9269 | 99 | 24115 | 55 | 55017 | 89 | 91113 | 109 | 24041-BX | 56 |
| 9270 | 99 | 24117 | 55 | 55018 | 89 | 91126 | 97 | 24046-BX | 56 |
| 9270-01 | 100 | 24124 | 55 | 55019 | 89 | 91800 | 99 | 24059-08 | 55 |
| 9276-09 | 96 | 24200 | 58 | 55020 | 89 | 91801 | 100 | 24059-15 | 55 |
| 9500 | 104 | 24213 | 55 | 55021 | 89 | 91812 | 100 | 24063-08 | 55 |

Alphanumeric Part Number Index

| Part Number | Page | Part Number | Page | Part Number | Page | Part Number | Page | Part Number | Page |
|--------------|------|---------------|------|-------------|------|--------------|------|-------------|------|
| 24106-07 | 55 | 30138-40 | 29 | 55020-04 | 89 | 58311-13 | 80 | 59024-200 | 91 |
| 24107-BX | 55 | 30171-10 | 29 | 55020-20-BP | 89 | 58311-18 | 80 | 59024-218 | 91 |
| 24117-01 | 55 | 30171-15 | 29 | 55021-04 | 89 | 58312-A4 | 80 | 59024-33 | 91 |
| 24213-01 | 55 | 30171-20 | 29 | 55021-07 | 89 | 58312-AG | 80 | 59024-35 | 91 |
| 24213-03 | 55 | 30171-30 | 29 | 55025-01 | 88 | 58312-C4 | 80 | 59024-36 | 91 |
| 24401-01 | 57 | 30172-10 | 29 | 55025-02 | 88 | 58312-G4 | 80 | 59024-38 | 91 |
| 24401-04 | 57 | 30172-15 | 29 | 55025-03 | 88 | 58312-R2 | 80 | 68159-05 | 106 |
| 24420-BX | 55 | 30172-20 | 29 | 55025-04 | 88 | 58312-R4 | 80 | 71092-02 | 103 |
| 24450-02 | 58 | 30172-30 | 29 | 55033-01 | 89 | 58326-01-BX | 83 | 72079-01 | 107 |
| 24505-01 | 70 | 30409-10 | 30 | 55033-02 | 89 | 58326-06 | 83 | 72171-02 | 104 |
| 24512-10 | 57 | 30409-15 | 30 | 55046-04 | 89 | 58326-11 | 83 | 74600-02 | 107 |
| 24610-G10-BX | 57 | 30409-20 | 30 | 55049-01 | 89 | 58326-15 | 83 | 74601-01 | 107 |
| 24612-03 | 57 | 30409-25 | 30 | 55054-04 | 89 | 58326-27 | 83 | 74601-06 | 107 |
| 24612-10 | 57 | 30409-30 | 30 | 55065-02 | 89 | 58326-29 | 83 | 74601-12 | 107 |
| 24624-10 | 57 | 30410-10-BX | 27 | 55065-03 | 89 | 58327-01 | 82 | 75212-04 | 106 |
| 24812-01 | 57 | 30410-15 | 27 | 551001-BX | 90 | 58327-06 | 82 | 75217-04 | 106 |
| 24824-01 | 57 | 30410-20 | 27 | 551800-BX | 90 | 58328-01 | 81 | 75221-06 | 106 |
| 26100-BP | 122 | 30410-25 | 27 | 551846-BX | 90 | 58328-02 | 81 | 75221-09 | 106 |
| 30055-10 | 29 | 30410-30 | 27 | 56000-01 | 85 | 58328-04 | 81 | 75228-03 | 106 |
| 30055-15 | 29 | 30419-10 | 27 | 56000-04 | 85 | 58328-100-BP | 81 | 75228-04 | 106 |
| 30055-20 | 29 | 30419-15 | 27 | 56000-08 | 85 | 58328-101-BP | 81 | 75600-01 | 105 |
| 30055-25 | 29 | 30419-20 | 27 | 56027-01 | 82 | 58328-103-BP | 81 | 75600-02 | 105 |
| 30055-30 | 29 | 30419-25 | 27 | 56300-01 | 85 | 58328-11 | 81 | 75600-04 | 105 |
| 30055-40 | 29 | 30507-60 | 29 | 56327-01 | 82 | 58328-12-BX | 81 | 75600-05 | 105 |
| 30055-50 | 29 | 30507-80 | 29 | 57000-01 | 85 | 58328-13 | 81 | 75600-07 | 105 |
| 30056-10 | 29 | 3298xxx.H | 17 | 57000-04 | 85 | 58328-35 | 81 | 75600-25 | 105 |
| 30056-15 | 29 | 3298xxx.Z | 17 | 57000-10 | 85 | 58328-55 | 81 | 75601-14 | 105 |
| 30056-20 | 29 | 3298xxx.ZXSTA | 17 | 57000-23 | 85 | 58328-58 | 81 | 75602-02 | 105 |
| 30056-25 | 29 | 46206-04 | 41 | 57003-01 | 85 | 58328-62 | 81 | 75602-10 | 104 |
| 30056-30 | 29 | 46210-02 | 70 | 57004-10 | 85 | 58332-04-BP | 81 | 75603-09 | 105 |
| 30056-40 | 29 | 46210-03 | 70 | 57006-01 | 85 | 58332-20-BP | 81 | 75705-01 | 104 |
| 30056-50 | 29 | 46211-01 | 70 | 57006-07 | 85 | 58332-21-BP | 81 | 75712-04 | 104 |
| 30062-20-BX | 29 | 46211-R | 70 | 57007-11 | 85 | 58332-22-BP | 81 | 75904-01 | 67 |
| 30062-30 | 29 | 46377-10 | 38 | 57013-08 | 85 | 58332-23-BP | 81 | 75904-02 | 67 |
| 30063-10 | 29 | 46377-12 | 38 | 57014-03 | 85 | 58332-25-BP | 81 | 75904-03 | 67 |
| 30063-20 | 29 | 46377-18 | 38 | 57300-01 | 85 | 58332-26-BP | 81 | 75920-05 | 62 |
| 30063-30 | 29 | 46377-6 | 38 | 57300-02 | 85 | 58332-27-BP | 81 | 75920-10 | 62 |
| 30090-2 | 28 | 46377-8 | 38 | 57300-03 | 85 | 58332-28-BP | 81 | 75921-10 | 62 |
| 30090-3 | 28 | 46379-6 | 38 | 57300-11 | 85 | 58332-29-BP | 81 | 80101-B | 70 |
| 30090-4 | 28 | 46379-8 | 38 | 57300-22 | 85 | 58332-30-BP | 81 | 81192-BX | 118 |
| 30090-6 | 28 | 48540-01-BX | 51 | 58027-01 | 82 | 58332-31-BP | 81 | 81264-01 | 92 |
| 30090-8 | 28 | 48541-01-BX | 51 | 58027-02 | 82 | 58332-32-BP | 81 | 81264-02 | 92 |
| 30128-10 | 29 | 48636-01-BX | 51 | 58027-03 | 82 | 58332-33-BP | 81 | 81264-05 | 92 |
| 30128-15 | 29 | 50046-09 | 102 | 58027-04 | 82 | 58332-34-BP | 81 | 81264-07 | 92 |
| 30128-20 | 29 | 54100-01 | 88 | 58027-06 | 82 | 59024-100 | 91 | 81298-02 | 106 |
| 30128-30 | 29 | 54101-01 | 88 | 58027-07 | 82 | 59024-104 | 91 | 81298-34 | 106 |
| 30128-40 | 29 | 54107-01 | 88 | 58027-08 | 82 | 59024-106 | 91 | 82065-02 | 70 |
| 30137-10 | 29 | 54109-01 | 88 | 58027-11 | 82 | 59024-108-BX | 91 | 82159-02-BP | 84 |
| 30137-15 | 29 | 54204-01 | 82 | 58027-18 | 82 | 59024-110 | 91 | 82159-1 | 84 |
| 30137-20 | 29 | 55014-05 | 89 | 58311-01 | 80 | 59024-116 | 91 | 82159-2 | 84 |
| 30137-30 | 29 | 55015-03 | 92 | 58311-02 | 80 | 59024-118 | 91 | 82159-3 | 84 |
| 30138-10 | 29 | 55016-06 | 89 | 58311-07 | 80 | 59024-12 | 91 | 83280-02 | 99 |
| 30138-15 | 29 | 55017-02 | 89 | 58311-08 | 80 | 59024-14 | 91 | 83280-03 | 99 |
| 30138-30-BX | 29 | 55020-02 | 89 | 58311-11 | 80 | 59024-15 | 91 | 83280-05 | 99 |

Alphanumeric Part Number Index

| Part Number | Page | Part Number | Page | Part Number | Page | Part Number | Page | Part Number | Page |
|-------------|------|----------------|------|----------------|------|-----------------|------|--------------|------|
| 83285-01 | 77 | 95061-BX | 72 | M-121 | 117 | M-612 | 98 | PL-521-AC | 120 |
| 83288-BX | 77 | 95062-10 | 72 | M-284 | 68 | M-626 | 98 | PL-521-GC | 120 |
| 86099-2-BX | 28 | 95062-13 | 72 | M-284-01 | 68 | M-626-02 | 98 | PL-521-RC | 120 |
| 86099-3 | 28 | 95062-17 | 72 | M-284-02 | 68 | M-628 | 102 | PL-522-AC | 120 |
| 86099-4 | 28 | 95062-50-BX | 72 | M-284-09-BP | 68 | M-630 | 102 | PL-522-GC | 120 |
| 86099-5 | 28 | 95062-57-BX | 72 | M-284-26 | 68 | M-641-01 | 39 | PL-522-RC | 120 |
| 86126-12 | 28 | 95521-01 | 75 | M-284-A | 68 | M-643-01 | 39 | PL-523-AC | 120 |
| 86126-2 | 28 | 95521-B | 75 | M-288 | 75 | M-674-BX | 39 | PL-523-BC | 120 |
| 86126-4 | 28 | 95522-A | 74 | M-289-BX | 68 | M-700 | 76 | PL-523-CC | 120 |
| 86126-6 | 28 | 95524-A | 74 | M-290 | 68 | M-712 | 76 | PL-523-GC | 120 |
| 86126-8 | 28 | 95525-A | 74 | M-290-01 | 68 | M-712-09 | 76 | PL-523-RC | 120 |
| 87167-01-BP | 84 | 95613-BX | 75 | M-290-05 | 68 | M-750 | 69 | PL-524-AC | 120 |
| 880064S | 62 | 95633-A | 74 | M-320-RC000-BX | 122 | M-754 | 69 | PL-524-GC | 120 |
| 880107S | 54 | 95634-01 | 74 | M-414-01 | 39 | M-850 | 76 | PL-524-RC | 120 |
| 880175S | 62 | 98635-01 | 77 | M-415-01 | 39 | M-914-01 | 98 | PL-525-AC | 120 |
| 888842000A | 62 | BPDMA104HXF1 | 45 | M-426 | 40 | MAHC0001TXJ | 33 | PL-525-GC | 120 |
| 90005-01 | 104 | BUCBxxx.Z | 28 | M-427 | 40 | MAHC0001ZXJ | 33 | PL-525-RC | 120 |
| 90005-03 | 104 | DL-13 | 122 | M-428 | 40 | MAHC0001ZXJA | 33 | PL-526-AC | 120 |
| 90030-01 | 96 | DL-21 | 122 | M-429 | 40 | MC-250012-DN | 59 | PL-526-GC | 120 |
| 90030-04 | 96 | FHAC0001SXJ | 34 | M-432 | 122 | MC-250012-NN | 59 | PL-526-RC | 120 |
| 90030-12 | 96 | FHAC0001XP | 34 | M-448 | 41 | MC-250012-RN | 59 | PL-612-A | 120 |
| 90030-24 | 96 | FHAC0002SXJ | 34 | M-448-02 | 41 | MCASxxx.V | 16 | PL-612-B | 120 |
| 90030-33 | 96 | FHAC0002XP | 34 | M-449 | 41 | MCASxxx.VS | 16 | PL-612-G | 120 |
| 90030-43 | 96 | FHJC1001G | 35 | M-456 | 40 | MCASxxx.XP | 16 | PL-612-R | 120 |
| 90030-53 | 96 | FHJC1002G | 35 | M-458 | 122 | MCASxxx.XPS | 16 | PL-624-A | 120 |
| 90036-02-BX | 96 | FHJC1002L | 35 | M-476 | 102 | MIC2xxx.V | 15 | PL-624-B | 120 |
| 90036-10 | 96 | FHJC2002G | 35 | M-482 | 102 | MIC2xxx.VP | 15 | PL-624-G | 120 |
| 90043-07 | 97 | FHJC2002L | 35 | M-484 | 90 | MIC2xxx.ZXPRO | 15 | PL-624-R | 120 |
| 90043-31 | 97 | FHLM0200Z | 36 | M-485 | 98 | MIC3xxx.VP | 15 | PL-85-AC000 | 121 |
| 90047-01 | 98 | FHLM0200ZPA | 36 | M-489 | 76 | MIC3xxx.ZXPRO | 15 | PL-85-GC000 | 121 |
| 90048-01 | 98 | FHM20200Z | 36 | M-489-03 | 76 | PDM21001LXM | 44 | PL-85-RC000 | 121 |
| 91109-03 | 97 | FHM20200ZPA | 36 | M-490 | 98 | PDM31001ZXM | 44 | PL-86-AC000 | 121 |
| 91812-02 | 100 | FLEC3000Z-0 | 47 | M-492 | 98 | PDM31002ZXM | 44 | PL-86-GC000 | 121 |
| 92107-04 | 110 | FLEC3000Z-0U | 47 | M-493 | 90 | PDM32001ZXM | 44 | PL-86-RC000 | 121 |
| 95060-01 | 72 | JBPT0001Z | 70 | M-497 | 76 | PDM32003ZXM | 44 | R2-400112-RN | 59 |
| 95060-02 | 72 | JBPT2N02ZXB | 70 | M-524 | 98 | PDM32004ZXM | 44 | RA-200024-DS | 59 |
| 95060-03 | 72 | JBPT2P01ZXR | 70 | M-527 | 102 | PDM33001ZXM | 44 | RA-400012-DS | 59 |
| 95060-04 | 72 | JBPT3N03ZXB | 70 | M-530 | 102 | PDM33003ZXM | 44 | RA-400112-DN | 59 |
| 95060-07 | 72 | JBPT3P01ZXB | 70 | M-531 | 102 | PDM33004ZXM | 44 | RA-400112-NN | 59 |
| 95060-21 | 72 | JBPT3P02ZXB | 70 | M-532 | 102 | PDM61001ZXM | 45 | RA-400112-RN | 59 |
| 95060-23 | 72 | JCASxxx.X | 16 | M-54111-01 | 90 | PDM71001ZXM | 44 | RA-700112-DN | 59 |
| 95060-24 | 72 | JCASxxx.XP | 16 | M-54111-02 | 90 | PDM71003ZXM | 44 | RA-700112-NN | 59 |
| 95060-26 | 72 | JLLNxxx.T | 20 | M-550 | 76 | PL-116-RC000-BX | 122 | RA-700112-RN | 59 |
| 95060-29 | 72 | JLLNxxx.V | 20 | M-550-14 | 76 | PL-118-AC001 | 122 | RC-200024-DS | 59 |
| 95060-34 | 72 | JLLNxxx.X | 20 | M-58031-01 | 83 | PL-118-GC001 | 122 | RC-200124-DN | 59 |
| 95060-36 | 72 | JLLSxxx.T | 20 | M-58031-02 | 83 | PL-118-RC000 | 122 | RC-200124-NN | 59 |
| 95060-43 | 72 | JLLSxxx.V | 20 | M-58031-04 | 83 | PL-118-RC001 | 122 | RC-200124-RN | 59 |
| 95060-50-BP | 72 | JLLSxxx.X | 20 | M-58031-07 | 83 | PL-2-BC000 | 121 | RC-400012-DS | 59 |
| 95060-60-BP | 72 | LFMX0006Z-01 | 47 | M-58031-08 | 83 | PL-2-GC000 | 121 | RC-400112-DN | 59 |
| 95061-01 | 72 | LFMX0007Z-01 | 47 | M-58031-09 | 83 | PL-2-RC000-BX | 121 | RC-400112-NN | 59 |
| 95061-04 | 72 | LJCAxxx.X | 16 | M-584 | 90 | PL-20-AC000 | 121 | RC-400112-RN | 59 |
| 95061-05 | 72 | LJCAxxx.XP | 16 | M-597 | 92 | PL-20-GC000 | 121 | RC-700112-DN | 59 |
| 95061-07 | 72 | LMINxxx.V | 13 | M-598 | 92 | PL-20-RC000 | 121 | RC-700112-NN | 59 |
| 95061-36 | 72 | LMINxxx.VP | 13 | M-606 | 102 | PL-36-AC000-BX | 121 | RC-700112-RN | 59 |
| 95061-50-BX | 72 | LMINxxx.ZXPROA | 13 | M-608 | 98 | PL-36-GC000 | 121 | ZCASxxx.XP | 17 |
| 95061-60-BX | 72 | M-115 | 117 | M-6110-05 | 76 | PL-36-RC000 | 121 | | |

Entire Vehicle **ELECTRICAL POWER** Expertise

Littelfuse manufactures products for your entire vehicle electrical system with components that help distribute, protect and control vehicle power. Review this schematic to learn how you can streamline your design and sourcing requirements.



1 Mixed Current Power Distribution

Custom Product



2 Battery Power Control

880086 - HD Series Relay



3 Primary Power Distribution

FLEC3000Z-0 - FLEC Series



4 Auxiliary Power Distribution

PDM71001ZX-M - HWB60-AL



5 Power Conversion

880211 - Liftgate Battery Charger

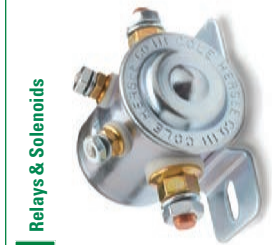

6 Relays & Solenoids

24059 - Continuous Duty Solenoid



7 Master Disconnect

75920 Series - Battery Switches



8 Switches

95060 Series - Ignition Switches



9 In-Line Fuse Holders

FHAC0001ZX-J - 04980921GXM5

Electrical Power Expertise For Material Handling

Littelfuse manufactures products for your entire vehicle electrical system with components that help distribute, protect and control vehicle power. Review this schematic to learn how you can streamline your design and sourcing requirements.



1 Sealed and Unsealed Fuses and Fuse Holders

Sealed ZCASE Fuse
0FH2020Z
LFFB003

2 Master Power Distribution Units

0FH20001Z

3 Integrated Power Relays

4 High and Low Current Fuses for Various Voltage Levels

MEGA Fuse
MINI Fuse
ZCASE Fuse
MAXI Fuse
CNN-E Fuse

5 Fuse and Relay Centers

8800039
HWB60-AL

6 Ignition, Rocker, Toggle, and Momentary Switches

58328-35
95060-01
5507

7 Active/Passive Electronics and Power Semi-Conductors

Need **MORE INFORMATION** about Commercial Vehicle Products?

Littelfuse publishes technical documents to help in the design and selection of products for your electrical systems. To learn more about a specific product or application, visit our online library at:

Littelfuse.com/Commercial-Vehicle-Technical-Center

- Extended Datasheets
- Application Notes
- CAD Drawings
- 2D Outlines
- 3D Models
- Glossary
- FAQ



Littelfuse.com/Catalogs

Littelfuse offers digital and printed catalogs, to request a copy, please contact Littelfuse or download the digital version on our website.

Our product catalogs feature circuit protection, power control and sensing products for OEM and aftermarket applications.

- Commercial Vehicle Aftermarket Catalog
- Automotive Passenger Car Catalog
- Automotive Fuse & Fuse Holder Selection Guide

Littelfuse.com/ContactUs

Contact Littelfuse support or find a local representative or distributor.



Littelfuse Aftermarket Products
Chicago, Illinois USA
+1 800 365 2653
cvp_info@Littelfuse.com

To learn more about specific
products or applications visit:
Littelfuse.com/Aftermarket



Компания «Океан Электроники» предлагает заключение долгосрочных отношений при поставках импортных электронных компонентов на взаимовыгодных условиях!

Наши преимущества:

- Поставка оригинальных импортных электронных компонентов напрямую с производств Америки, Европы и Азии, а так же с крупнейших складов мира;
- Широкая линейка поставок активных и пассивных импортных электронных компонентов (более 30 млн. наименований);
- Поставка сложных, дефицитных, либо снятых с производства позиций;
- Оперативные сроки поставки под заказ (от 5 рабочих дней);
- Экспресс доставка в любую точку России;
- Помощь Конструкторского Отдела и консультации квалифицированных инженеров;
- Техническая поддержка проекта, помощь в подборе аналогов, поставка прототипов;
- Поставка электронных компонентов под контролем ВП;
- Система менеджмента качества сертифицирована по Международному стандарту ISO 9001;
- При необходимости вся продукция военного и аэрокосмического назначения проходит испытания и сертификацию в лаборатории (по согласованию с заказчиком);
- Поставка специализированных компонентов военного и аэрокосмического уровня качества (Xilinx, Altera, Analog Devices, Intersil, Interpoint, Microsemi, Actel, Aeroflex, Peregrine, VPT, Syfer, Eurofarad, Texas Instruments, MS Kennedy, Miteq, Cobham, E2V, MA-COM, Hittite, Mini-Circuits, General Dynamics и др.);

Компания «Океан Электроники» является официальным дистрибьютором и эксклюзивным представителем в России одного из крупнейших производителей разъемов военного и аэрокосмического назначения «JONHON», а так же официальным дистрибьютором и эксклюзивным представителем в России производителя высокотехнологичных и надежных решений для передачи СВЧ сигналов «FORSTAR».



JONHON

«JONHON» (основан в 1970 г.)

Разъемы специального, военного и аэрокосмического назначения:

(Применяются в военной, авиационной, аэрокосмической, морской, железнодорожной, горно- и нефтедобывающей отраслях промышленности)

«FORSTAR» (основан в 1998 г.)

ВЧ соединители, коаксиальные кабели,
кабельные сборки и микроволновые компоненты:

(Применяются в телекоммуникациях гражданского и специального назначения, в средствах связи, РЛС, а так же военной, авиационной и аэрокосмической отраслях промышленности).



Телефон: 8 (812) 309-75-97 (многоканальный)

Факс: 8 (812) 320-03-32

Электронная почта: ocean@oceanchips.ru

Web: <http://oceanchips.ru/>

Адрес: 198099, г. Санкт-Петербург, ул. Калинина, д. 2, корп. 4, лит. А