

# RM84 / RM85 / RM87

## Miniature Electromagnetic Relays



- Miniature dimensions
- 5000 V / 10 mm reinforced insulation
- Available special versions with the increased dielectric strength of the contact clearance
- IP67 flux proof, water proof and sealed cover protection (For IP40 unsealed, contact Altech)
- Cadmium - free contacts
- For PCB and plug-in sockets

| Contact Data                              |                             | RM84   | RM85   | RM87   |
|---|-----------------------------|--|--|--|
| <b>No. and type of contacts</b>           |                             | <b>DPDT, DPST (2NO)</b>  | <b>SPDT, SPST (1NO)</b>  | <b>SPDT, SPST (1NO)</b>  |
| Contact material                          |                             | AgNi   | AgNi   | AgNi   |
| Rated / max. switching voltage            | AC                          | 250 V / 440 V  | 250 V / 440 V  | 250 V / 440 V  |
| Min. switching voltage                    |                             | 5 V  | 5 V  | 5 V  |
| Rated load (capacity)                     |                             | 8 A / 250 V AC   | 16 A / 250 V AC  | 12 A / 250 V AC  |
|   | AC15                        | 3 A / 120 V; 1.5 A / 240 V (B300)                                    | 3 A / 120 V; 1.5 A / 240 V (B300)                                    | 3 A / 120 V; 1.5 A / 240 V (B300)                                    |
|   | AC3                         | 550 W (single-phase motor)   | 750 W (single-phase motor)   | 750 W (single-phase motor)   |
|   | DC1                         | 8 A / 24 V DC (see Fig. 3.1)   | 16 A / 24 V DC (see Fig. 3.2)  | 12 A / 24 V DC (see Fig. 3.3)  |
|   | DC13                        | 0.22 A / 120 V; 0.1 A / 250 V (R300)                                 | 0.22 A / 120 V; 0.1 A / 250 V (R300)                                 | 0.22 A / 120 V; 0.1 A / 250 V (R300)                                 |
| Min. switching current                    |                             | 5 mA   | 5 mA   | 5 mA   |
| Max. inrush current                       |                             | 12 A   | 24 A   | 18 A   |
| <b>Rated current</b>                      |                             | <b>8 A</b>   | <b>16 A</b>  | <b>12 A</b>  |
| Max. breaking capacity                    | AC1                         | 2 000 VA   | 4 000 VA   | 3 000 VA   |
| Min. breaking capacity                    |                             | 0.3 W  | 0.3 W  | 0.3 W  |
| Contact resistance                        |                             | ≤ 100 mΩ   | ≤ 100 mΩ   | ≤ 100 mΩ   |
| Max. operating frequency                  |                             | 600 cycles/hour  | 600 cycles/hour  | 600 cycles/hour  |
|   | • at rated load             | 72000 cycles/hour  | 72000 cycles/hour  | 72000 cycles/hour  |
|   | • no load                   |  |  |  |
| <b>Coil Data</b>                          |                             |  |  |  |
| Rated voltage                             | 50/60 Hz AC                 | 12 ... 240 V   | 12 ... 240 V   | 12 ... 240 V   |
|   | DC                          | 3 ... 110 V  | 3 ... 110 V  | 3 ... 110 V  |
| Must release voltage                      |                             | AC: ≥ 0.15 U <sub>N</sub> ; DC: ≥ 0.1 U <sub>N</sub>                 | AC: ≥ 0.15 U <sub>N</sub> ; DC: ≥ 0.1 U <sub>N</sub>                 | AC: ≥ 0.15 U <sub>N</sub> ; DC: ≥ 0.1 U <sub>N</sub>                 |
| Operating range of supply voltage         |                             | see page 80 and Fig. 4.1. 5.1  | see page 80 and Fig. 4.2. 5.2  | see page 80 and Fig. 4.3. 5.3  |
| Rated power consumption                   | AC                          | 0.75 VA  | 0.75 VA  | 0.75 VA  |
|   | DC                          | 0.4 ... 0.48 W   | 0.4 ... 0.48 W   | 0.4 ... 0.48 W   |
| <b>Insulation</b>                         |                             |  |  |  |
| Insulation rated voltage                  |                             | 400 V AC   | 400 V AC   | 400 V AC   |
| Rated surge voltage                       |                             | 4000 V 1.2 / 50 μs   | 4000 V 1.2 / 50 μs   | 4000 V 1.2 / 50 μs   |
| Overvoltage category                      |                             | III  | III  | III  |
| Insulation pollution degree               |                             | 3  | 3  | 3  |
| Dielectric strength                       |                             | 5000 V AC type of insulation: reinforced                             | 5000 V AC type of insulation: reinforced                             | 5000 V AC type of insulation: reinforced                             |
|   | • between coil and contacts | 1000 V AC type of clearance: micro-disconnection                     | 1000 V AC type of clearance: micro-disconnection                     | 1000 V AC type of clearance: micro-disconnection                     |
|   | • contact clearance         | 2000 V AC contacts DPST (2NO).<br>type of clearance: full-disconnect | 2000 V AC contacts DPST (2NO).<br>type of clearance: full-disconnect | 2000 V AC contacts SPST (1NO).<br>type of clearance: full-disconnect |
|   | • pole - pole               | 2500 V AC type of insulation: basic                                  | -  | -  |
| Contact - coil distance                   |                             | ≥ 10 mm  | ≥ 10 mm  | ≥ 10 mm  |
|   | • clearance                 | ≥ 10 mm  | ≥ 10 mm  | ≥ 10 mm  |
|   | • creepage                  |  |  |  |
| <b>General data</b>                       |                             |  |  |  |
| Operating / release time (typical values) |                             | 7 ms / 3 ms  | 7 ms / 3 ms  | 7 ms / 3 ms  |
| Electrical life                           |                             |  |  |  |
|   | • resistive                 | > 10 <sup>6</sup> ; 8 A. 250 V AC                                    | > 0.7 x 10 <sup>6</sup> ; 16 A. 250 V AC                             | > 10 <sup>6</sup> ; 12 A. 250 V AC                                   |
|   | • cosφ                      | see Fig. 2.1   | see Fig. 2.2   | see Fig. 2.3   |
|   | • DC L/R=40 ms              | > 10 <sup>6</sup> ; 0.15 A. 220 V DC                                 | > 10 <sup>6</sup> ; 0.15 A. 220 V DC                                 | > 10 <sup>6</sup> ; 0.15 A. 220 V DC                                 |
| Mechanical life (cycles)                  |                             | > 3 x 10 <sup>7</sup>  | > 3 x 10 <sup>7</sup>  | > 3 x 10 <sup>7</sup>  |
| Dimensions (L x W x H)                    |                             | 29 x 12.7 x 15.7 mm  | 29 x 12.7 x 15.7 mm  | 29 x 12.7 x 15.7 mm  |
| Weight                                    |                             | 14 g   | 14 g   | 14 g   |
| Ambient temperature                       |                             |  |  |  |
|   | • storage                   | -40...+85 °C   | 40...+85 °C  | 40...+85 °C  |
|   | • operating                 | AC: -40...+70 °C DC: -40...+85 °C                                    | AC: -40...+70 °C DC: -40...+85 °C                                    | AC: -40...+70 °C DC: -40...+85 °C                                    |
| Cover protection category                 |                             | IP 67 PN-EN 60529  | IP 67 PN-EN 60529  | IP 67 PN-EN 60529  |
| Environmental protection                  |                             | RTIII PN-EN 116000-3   | RTIII PN-EN 116000-3   | RTIII PN-EN 116000-3   |
| Shock resistance (NO/NC)                  |                             | 20 g   | 30 g   | 30 g   |
| Vibration resistance                      |                             | 10 g / 5 g 10...150 Hz   | 10 g 10...150 Hz   | 10 g 10...150 Hz   |
| Solder bath temperature                   |                             | max. 270 °C  | max. 270 °C  | max. 270 °C  |
| Soldering time                            |                             | max. 5 s   | max. 5 s   | max. 5 s   |

# RM84 / RM85 / RM87

## Miniature Electromagnetic Relays



**RM84**



### CONNECTION DIAGRAM



|                |                |   |
|----------------|----------------|---|
| Terminal (pin) | A1(1); A2(2)   | 22(3); 21(4); 24(5);<br>12(6); 11(7); 14(8) |
| [mm]           | ∅ 0.6          | 0.5 x 0.9                                   |
| Drilling hole: |                |   |
| • for relays   | ∅ 1.3 + 0.1 mm |   |
| • for sockets  | ∅ 1.5 + 0.1 mm |   |

### DIMENSIONS



### LOAD CHARTS

**Electrical life at AC resistive load.** Switching frequency: 600 cycles/hour      Fig. 1.1



**Electrical life reduction factor at AC inductive load**      Fig. 2.1



**Max. DC resistive load breaking capacity**      Fig. 3.1



**Coil operating range - DC**      Fig. 4.1



**Coil operating range - AC 50 Hz**      Fig. 5.1



#### Description of Fig. 4.1 and 5.1

**A** - relations between make voltage and ambient temperature at no load on contacts. Coil temperature and ambient temperature are equal before coil energizing. Make voltage is not higher than the value read on Y axis (multiplication of rated voltage).  
**B** - relations between make voltage and ambient temperature after initial coil heating up with 1.1 U<sub>n</sub> at continues load of I<sub>n</sub> on contacts. Make voltage is not higher than the value read on Y axis (multiplication of rated voltage).  
 1, 2, 3 - values on Y axis represent allowed overvoltage on coil at certain ambient temperature and contact load:  
 1 - no load  
 2 - 50% of rated load  
 3 - rated load

# RM84 / RM85 / RM87

## Miniature Electromagnetic Relays



**RM85**



### CONNECTION DIAGRAM



| Terminal (pin) | A1(1); A2(2)   | 22(3); 21(4); 24(5);<br>12(6); 11(7); 14(8) |
|----------------|----------------|---|
| [mm]           | Ø 0.6          | 0.5 x 0.9                                   |
| Drilling hole: |                |   |
| • for relays   | Ø 1.3 + 0.1 mm |   |
| • for sockets  | Ø 1.5 + 0.1 mm |   |

**RM85** terminals are doubled for each contact.  
Both terminals are to be used while connecting to load.

### DIMENSIONS



### LOAD CHARTS

**Electrical life at AC resistive load.**  
Switching frequency: 600 cycles/hour Fig. 1.2



**Electrical life reduction factor at AC inductive load** Fig. 2.2



**Max. DC resistive load breaking capacity** Fig. 3.2



**Coil operating range - DC** Fig. 4.2



**Coil operating range - AC 50 Hz** Fig. 5.2



**Description of Fig. 4.2 and 5.2**

**A** - relations between make voltage and ambient temperature at no load on contacts. Coil temperature and ambient temperature are equal before coil energizing. Make voltage is not higher than the value read on Y axis (multiplication of rated voltage).  
**B** - relations between make voltage and ambient temperature after initial coil heating up with  $1.1 U_n$  at continues load of  $I_n$  on contacts. Make voltage is not higher than the value read on Y axis (multiplication of rated voltage).  
**1, 2, 3** - values on Y axis represent allowed overvoltage on coil at certain ambient temperature and contact load:  
1 - no load  
2 - 50% of rated load  
3 - rated load

# RM84 / RM85 / RM87

## Miniature Electromagnetic Relays



**RM87**



### CONNECTION DIAGRAM



| Terminal (pin)                                 | A1(1); A2(2) | 12(3); 11(4); 14(5) |
|--|--------------|---------------------|
| [mm]   | Ø 0.6        | 0.5 x 0.9           |
| Drilling hole:                                 |              |                     |
| • for relays                    Ø 1.3 + 0.1 mm |              |                     |
| • for sockets                  Ø 1.5 + 0.1 mm  |              |                     |

### DIMENSIONS



### LOAD CHARTS

**Electrical life at AC resistive load.** Fig. 1.3  
Switching frequency: 600 cycles/hour



**Electrical life reduction factor at AC inductive load** Fig. 2.3



**Max. DC resistive load breaking capacity** Fig. 3.3  
- standard version



**Coil operating range - DC** Fig. 4.3  
- standard version



**Coil operating range - AC 50 Hz** Fig. 5.3



**Description of Fig. 4.3 and 5.3**

**A** - relations between make voltage and ambient temperature at no load on contacts. Coil temperature and ambient temperature are equal before coil energizing. Make voltage is not higher than the value read on Y axis (multiplication of rated voltage). **B** - relations between make voltage and ambient temperature after initial coil heating up with 1,1 U<sub>n</sub> at continues load of I<sub>n</sub> on contacts. Make voltage is not higher than the value read on Y axis (multiplication of rated voltage).  
1, 2, 3 - values on Y axis represent allowed overvoltage on coil at certain ambient temperature and contact load: 1 - no load; 2 - 50% of rated load; 3 - rated load

# RM84 / RM85 / RM87

## Miniature Electromagnetic Relays

### R84 DPDT AC 50/60Hz & DC coil

| Part Number                | Coil Voltage (V) | Coil Type  | Coil resistance at 20 °C in Ω | Coil operating range |                |
|----------------------------|------------------|------------|-------------------------------|----------------------|----------------|
|                            |                  |            |                               | min. (at 20°C)       | max. (at 55°C) |
| ▶ <b>RM84-2012-35-1012</b> | 12               | DC         | 360                           | 8.4                  | 30.6           |
| ▶ <b>RM84-2012-35-1024</b> | 24               | DC         | 1440                          | 16.8                 | 61.2           |
| ▶ RM84-2012-35-1110        | 110              | DC         | 25200                         | 77.0                 | 280.0          |
| ▶ <b>RM84-2012-35-5120</b> | 120              | AC 50/60Hz | 10200                         | 96.0                 | 144.0          |
| ▶ <b>RM84-2012-35-5230</b> | 230              | AC 50/60Hz | 38500                         | 184.0                | 276.0          |

### R84 DPST(2NO) AC 50/60Hz & DC coil

| Part Number                | Coil Voltage (V) | Coil Type  | Coil resistance at 20 °C in Ω | Coil operating range |                |
|----------------------------|------------------|------------|-------------------------------|----------------------|----------------|
|                            |                  |            |                               | min. (at 20°C)       | max. (at 55°C) |
| ▶ <b>RM84-2022-35-1012</b> | 12               | DC         | 360                           | 8.4                  | 30.6           |
| ▶ <b>RM84-2022-35-1024</b> | 24               | DC         | 1440                          | 16.8                 | 61.2           |
| ▶ RM84-2022-35-1110        | 110              | DC         | 25200                         | 77.0                 | 280.0          |
| ▶ <b>RM84-2022-35-5120</b> | 120              | AC 50/60Hz | 10200                         | 96.0                 | 144.0          |
| ▶ <b>RM84-2022-35-5230</b> | 230              | AC 50/60Hz | 38500                         | 184.0                | 276.0          |

### R85 SPDT AC 50/60Hz & DC coil

| Part Number                | Coil Voltage (V) | Coil Type  | Coil resistance at 20 °C in Ω | Coil operating range |                |
|----------------------------|------------------|------------|-------------------------------|----------------------|----------------|
|                            |                  |            |                               | min. (at 20°C)       | max. (at 55°C) |
| ▶ <b>RM85-2011-35-1012</b> | 12               | DC         | 360                           | 8.4                  | 30.6           |
| ▶ <b>RM85-2011-35-1024</b> | 24               | DC         | 1440                          | 16.8                 | 61.2           |
| ▶ RM85-2011-35-1110        | 110              | DC         | 25200                         | 77.0                 | 280.0          |
| ▶ <b>RM85-2011-35-5120</b> | 120              | AC 50/60Hz | 10200                         | 96.0                 | 144.0          |
| ▶ <b>RM85-2011-35-5230</b> | 230              | AC 50/60Hz | 38500                         | 184.0                | 276.0          |

### R85 SPST(1NO) AC 50/60Hz & DC coil

| Part Number                | Coil Voltage (V) | Coil Type  | Coil resistance at 20 °C in Ω | Coil operating range |                |
|----------------------------|------------------|------------|-------------------------------|----------------------|----------------|
|                            |                  |            |                               | min. (at 20°C)       | max. (at 55°C) |
| ▶ <b>RM85-2021-35-1012</b> | 12               | DC         | 360                           | 8.4                  | 30.6           |
| ▶ <b>RM85-2021-35-1024</b> | 24               | DC         | 1440                          | 16.8                 | 61.2           |
| ▶ RM85-2021-35-1110        | 110              | DC         | 25200                         | 77.0                 | 280.0          |
| ▶ <b>RM85-2021-35-5120</b> | 120              | AC 50/60Hz | 10200                         | 96.0                 | 144.0          |
| ▶ <b>RM85-2021-35-5230</b> | 230              | AC 50/60Hz | 38500                         | 184.0                | 276.0          |

### R87 SPDT AC 50/60Hz & DC coil

| Part Number                 | Coil Voltage (V) | Coil Type  | Coil resistance at 20 °C in Ω | Coil operating range |                |
|-----------------------------|------------------|------------|-------------------------------|----------------------|----------------|
|                             |                  |            |                               | min. (at 20°C)       | max. (at 55°C) |
| ▶ <b>RM87N-2011-35-1012</b> | 12               | DC         | 360                           | 8.4                  | 30.6           |
| ▶ <b>RM87N-2011-35-1024</b> | 24               | DC         | 1440                          | 16.8                 | 61.2           |
| ▶ RM87N-2011-35-1110        | 110              | DC         | 25200                         | 77.0                 | 280.0          |
| ▶ <b>RM87N-2011-35-5120</b> | 120              | AC 50/60Hz | 10200                         | 96.0                 | 144.0          |
| ▶ <b>RM87N-2011-35-5230</b> | 230              | AC 50/60Hz | 38500                         | 184.0                | 276.0          |

### R87 SPST(1NO) AC 50/60Hz & DC coil

| Part Number                 | Coil Voltage (V) | Coil Type  | Coil resistance at 20 °C in Ω | Coil operating range |                |
|-----------------------------|------------------|------------|-------------------------------|----------------------|----------------|
|                             |                  |            |                               | min. (at 20°C)       | max. (at 55°C) |
| ▶ <b>RM87N-2021-35-1012</b> | 12               | DC         | 360                           | 8.4                  | 30.6           |
| ▶ <b>RM87N-2021-35-1024</b> | 24               | DC         | 1440                          | 16.8                 | 61.2           |
| ▶ RM87N-2021-35-1110        | 110              | DC         | 25200                         | 77.0                 | 280.0          |
| ▶ <b>RM87N-2021-35-5120</b> | 120              | AC 50/60Hz | 10200                         | 96.0                 | 144.0          |
| ▶ <b>RM87N-2021-35-5230</b> | 230              | AC 50/60Hz | 38500                         | 184.0                | 276.0          |

\* waterproof version

▶ **BOLD** - Regular stocked items.

# RM84 / RM85 / RM87

Miniature Electromagnetic Relays - Plug-in Sockets and Accessories **Altech**<sup>®</sup>

## GZT80 (for RM84 / RM85)

Screw terminals  
 Max. tightening moment  
 for the terminal: 0.7 Nm  
 35 mm rail mount  
 acc. to PN-EN 60715  
 or on panel mounting  
 75.3 x 15.5 x 61(67) mm\*  
 Two poles, 5 mm pinout  
 12 A, 300 V AC



E22891



GZT80

### CONNECTION DIAGRAM



RM84 RM85

### DIMENSIONS



ZGGZ80 (see page 110)



GZT80-0040



GZM80-0041\*\*



GZT80-0035



Module type M... (see page 113)

## GZM80 (for RM84 / RM85)

Screw terminals  
 Max. tightening moment  
 for the terminal: 0.7 Nm  
 35 mm rail mount  
 acc. to PN-EN 60715  
 or on panel mounting  
 78.1 x 15.9 x 61(66.5) mm\*  
 Two poles, 5 mm pinout  
 12 A, 300 V AC



E22891



GZM80

### CONNECTION DIAGRAM



RM84 RM85

### DIMENSIONS



ZGGZ80 (see page 110)



GZT80-0040



GZM80-0041\*\*



GZT80-0035



Module type M... (see page 113)

\* In parenthesis is the height of the socket with plastic retainer clip. \*\* For lower profile application.

All accessories are sold separately.

# RM84 / RM85 / RM87

## Miniature Electromagnetic Relays - Plug-in Sockets and Accessories

### GZT92 (for RM87)

Screw terminals  
 Max. tightening moment  
 for the terminal: 0.7 Nm  
 35 mm rail mount  
 acc. to PN-EN 60715  
 or on panel mounting  
 75.3 x 15.5 x 61(67) mm\*  
 One pole, 3,5 mm  
 12 A, 300 V AC



E22891



GZT92



ZGGZ80 (see page 110)

### CONNECTION DIAGRAM



### DIMENSIONS

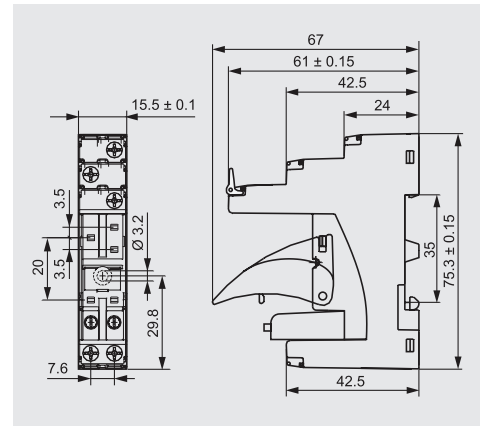

GZT80-0040



GZM80-0041\*\*



GZT80-0035



Module type M... (see page 113)

### GZM92 (for RM87)

Screw terminals  
 Max. tightening moment  
 for the terminal: 0.7 Nm  
 35 mm rail mount  
 acc. to PN-EN 60715  
 or on panel mounting  
 78.1 x 15.9 x 61(66.5) mm\*  
 One pole, 3,5 mm pinout  
 12 A, 300 V AC



E22891



GZM92



ZGGZ80 (see page 110)

### CONNECTION DIAGRAM

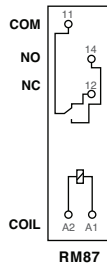

### DIMENSIONS

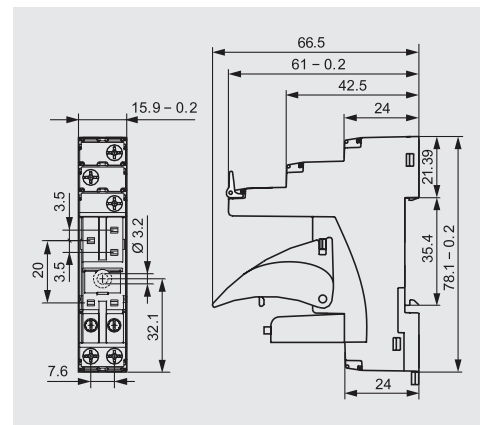

GZT80-0040



GZM80-0041\*\*



GZT80-0035



Module type M... (see page 113)

\* In parenthesis is the height of the socket with plastic retainer clip. \*\* For lower profile application.

All accessories are sold separately.

# RM84 / RM85 / RM87

## Miniature Electromagnetic Relays - Plug-in Sockets and Accessories

### GZMB80 (for RM84, RM85)

Spring terminals  
 Max. cross section of the cables:  
 1 x 0.2...1.5 mm<sup>2</sup>  
 (1 x 24...16 AWG)  
 Stripping length deinsulation:  
 9...11 mm  
 35 mm rail mount  
 acc. to PN-EN 60715  
 97 x 16 x 45.2(69) mm\*  
 Two poles, 5 mm pinout  
 10 A, 300 V AC



GZMB80

#### CONNECTION DIAGRAM



#### DIMENSIONS



GZMB80-0040



GZMB80-0041\*\*



TR



Module type M... (see page 113)

### GD50 (for RM84, RM85)

For RM84, RM85

For PCB  
 31.5 x 13 x 9 mm  
 Two poles, 5 mm pinout  
 8 A, 300 V AC



GD50

#### CONNECTION DIAGRAM



#### DIMENSIONS



MH16-2

### GD35 (for RM87N)

For RM87

For PCB  
 31.5 x 13 x 9 mm  
 One pole, 3.5 mm pinout  
 12 A, 300 V AC



GD35

#### CONNECTION DIAGRAM



#### DIMENSIONS



MH16-2

\* In parenthesis is the height of the socket with plastic retainer clip. \*\* For lower profile application.

All accessories are sold separately.



Компания «Океан Электроники» предлагает заключение долгосрочных отношений при поставках импортных электронных компонентов на взаимовыгодных условиях!

Наши преимущества:

- Поставка оригинальных импортных электронных компонентов напрямую с производств Америки, Европы и Азии, а так же с крупнейших складов мира;
- Широкая линейка поставок активных и пассивных импортных электронных компонентов (более 30 млн. наименований);
- Поставка сложных, дефицитных, либо снятых с производства позиций;
- Оперативные сроки поставки под заказ (от 5 рабочих дней);
- Экспресс доставка в любую точку России;
- Помощь Конструкторского Отдела и консультации квалифицированных инженеров;
- Техническая поддержка проекта, помощь в подборе аналогов, поставка прототипов;
- Поставка электронных компонентов под контролем ВП;
- Система менеджмента качества сертифицирована по Международному стандарту ISO 9001;
- При необходимости вся продукция военного и аэрокосмического назначения проходит испытания и сертификацию в лаборатории (по согласованию с заказчиком);
- Поставка специализированных компонентов военного и аэрокосмического уровня качества (Xilinx, Altera, Analog Devices, Intersil, Interpoint, Microsemi, Actel, Aeroflex, Peregrine, VPT, Syfer, Eurofarad, Texas Instruments, MS Kennedy, Miteq, Cobham, E2V, MA-COM, Hittite, Mini-Circuits, General Dynamics и др.);

Компания «Океан Электроники» является официальным дистрибьютором и эксклюзивным представителем в России одного из крупнейших производителей разъемов военного и аэрокосмического назначения «JONHON», а так же официальным дистрибьютором и эксклюзивным представителем в России производителя высокотехнологичных и надежных решений для передачи СВЧ сигналов «FORSTAR».



## JONHON

«JONHON» (основан в 1970 г.)

Разъемы специального, военного и аэрокосмического назначения:

(Применяются в военной, авиационной, аэрокосмической, морской, железнодорожной, горно- и нефтедобывающей отраслях промышленности)

«FORSTAR» (основан в 1998 г.)

ВЧ соединители, коаксиальные кабели, кабельные сборки и микроволновые компоненты:

(Применяются в телекоммуникациях гражданского и специального назначения, в средствах связи, РЛС, а так же военной, авиационной и аэрокосмической отраслях промышленности).



Телефон: 8 (812) 309-75-97 (многоканальный)

Факс: 8 (812) 320-03-32

Электронная почта: [ocean@oceanchips.ru](mailto:ocean@oceanchips.ru)

Web: <http://oceanchips.ru/>

Адрес: 198099, г. Санкт-Петербург, ул. Калинина, д. 2, корп. 4, лит. А