



Is Now Part of



ON Semiconductor®

To learn more about ON Semiconductor, please visit our website at
www.onsemi.com

Please note: As part of the Fairchild Semiconductor integration, some of the Fairchild orderable part numbers will need to change in order to meet ON Semiconductor's system requirements. Since the ON Semiconductor product management systems do not have the ability to manage part nomenclature that utilizes an underscore (_), the underscore (_) in the Fairchild part numbers will be changed to a dash (-). This document may contain device numbers with an underscore (_). Please check the ON Semiconductor website to verify the updated device numbers. The most current and up-to-date ordering information can be found at www.onsemi.com. Please email any questions regarding the system integration to Fairchild_questions@onsemi.com.

ON Semiconductor and the ON Semiconductor logo are trademarks of Semiconductor Components Industries, LLC dba ON Semiconductor or its subsidiaries in the United States and/or other countries. ON Semiconductor owns the rights to a number of patents, trademarks, copyrights, trade secrets, and other intellectual property. A listing of ON Semiconductor's product/patent coverage may be accessed at www.onsemi.com/site/pdf/Patent-Marking.pdf. ON Semiconductor reserves the right to make changes without further notice to any products herein. ON Semiconductor makes no warranty, representation or guarantee regarding the suitability of its products for any particular purpose, nor does ON Semiconductor assume any liability arising out of the application or use of any product or circuit, and specifically disclaims any and all liability, including without limitation special, consequential or incidental damages. Buyer is responsible for its products and applications using ON Semiconductor products, including compliance with all laws, regulations and safety requirements or standards, regardless of any support or applications information provided by ON Semiconductor. "Typical" parameters which may be provided in ON Semiconductor data sheets and/or specifications can and do vary in different applications and actual performance may vary over time. All operating parameters, including "Typicals" must be validated for each customer application by customer's technical experts. ON Semiconductor does not convey any license under its patent rights nor the rights of others. ON Semiconductor products are not designed, intended, or authorized for use as a critical component in life support systems or any FDA Class 3 medical devices or medical devices with a same or similar classification in a foreign jurisdiction or any devices intended for implantation in the human body. Should Buyer purchase or use ON Semiconductor products for any such unintended or unauthorized application, Buyer shall indemnify and hold ON Semiconductor and its officers, employees, subsidiaries, affiliates, and distributors harmless against all claims, costs, damages, and expenses, and reasonable attorney fees arising out of, directly or indirectly, any claim of personal injury or death associated with such unintended or unauthorized use, even if such claim alleges that ON Semiconductor was negligent regarding the design or manufacture of the part. ON Semiconductor is an Equal Opportunity/Affirmative Action Employer. This literature is subject to all applicable copyright laws and is not for resale in any manner.

NC7WZU04

TinyLogic® UHS Dual Unbuffered Inverter

Features

- Space saving SC70 6-lead package
- Ultra small MicroPak™ leadless package
- Unbuffered for crystal oscillator and analog applications
- Balanced output drive: $\pm 8\text{mA}$ at $4.5\text{V } V_{CC}$
- Broad V_{CC} operating range: 1.65V to 5.5V
- Low quiescent power: $I_{CC} < 1\mu\text{A}$ at $5\text{V } V_{CC}$, $T_A = 25^\circ\text{C}$

General Description

The NC7WZU04 is a dual unbuffered inverter from Fairchild's Ultra High Speed Series of TinyLogic® in the space saving SC70 6-lead package. The special purpose unbuffered circuit design is intended for crystal oscillator or analog applications. The internal circuit consists of only one-stage, the output, to allow for this part to be used in these oscillator or analog applications. The device is fabricated with advanced CMOS technology to achieve ultra high speed with high output drive while maintaining low static power dissipation over a very broad V_{CC} operating range. The device is specified to operate over the 1.65V to $5.5\text{V } V_{CC}$ range. The inputs are high impedance when V_{CC} is 0V . Inputs tolerate voltages up to 7V independent of V_{CC} operating voltage.

Ordering Information

| Order Number | Package Number | Package Code Top Mark | Package Description | Supplied As |
|--------------|----------------|-----------------------|-------------------------------------|---------------------------|
| NC7WZU04P6X | MAA06A | ZU4 | 6-Lead SC70, EIAJ SC88, 1.25mm Wide | 3k Units on Tape and Reel |
| NC7WZU04L6X | MAC06A | B5 | 6-Lead MicroPak, 1.0mm Wide | 5k Units on Tape and Reel |

 All packages are lead free per JEDEC: J-STD-020B standard.

Logic Symbol

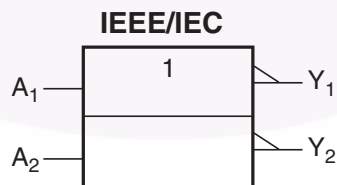

Connection Diagrams

Pin Assignment for SC70

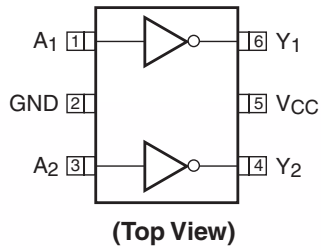

Pin One Orientation Diagram

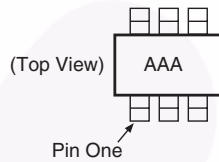

AAA represents Product Code Top Mark – see ordering code

Note: Orientation of Top Mark determines Pin One location. Read the top product code mark left to right, Pin One is the lower left pin (see diagram).

Pad Assignments for MicroPak

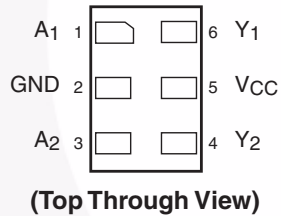

Pin Descriptions

| Pin Name | Description |
|---------------------------------|-------------|
| A ₁ , A ₂ | Data Inputs |
| Y ₁ , Y ₂ | Outputs |

Function Table

$$Y = \bar{A}$$

| Input | Output |
|-------|--------|
| A | Y |
| L | H |
| H | L |

H = HIGH Logic Level
L = LOW Logic Level

Absolute Maximum Ratings

The “Absolute Maximum Ratings” are those values beyond which the safety of the device cannot be guaranteed. The device should not be operated at these limits. The parametric values defined in the Electrical Characteristics tables are not guaranteed at the absolute maximum ratings. The “Recommended Operating Conditions” table will define the conditions for actual device operation.

| Symbol | Parameter | Rating |
|------------------|--|-----------------|
| V_{CC} | Supply Voltage | -0.5V to +7V |
| V_{IN} | DC Input Voltage | -0.5V to +7V |
| V_{OUT} | DC Output Voltage | -0.5V to +7V |
| I_{IK} | DC Input Diode Current @ $V_{IN} \leq -0.5V$ | -50mA |
| I_{OK} | DC Output Diode Current @ $V_{OUT} < -0.5V$ $V_{OUT} > 0.5V, V_{CC} = GND$ | -50mA +50mA |
| I_{OUT} | DC Output Current | $\pm 50mA$ |
| I_{CC}/I_{GND} | DC V_{CC}/GND Current | $\pm 100mA$ |
| T_{STG} | Storage Temperature | -65°C to +150°C |
| T_J | Junction Temperature under Bias | 150°C |
| T_L | Junction Lead Temperature (Soldering, 10 seconds) | 260°C |
| P_D | Power Dissipation @ +85°C SC70-6 Micropak-6 | 215mW 215mW |

Recommended Operating Conditions⁽¹⁾

The Recommended Operating Conditions table defines the conditions for actual device operation. Recommended operating conditions are specified to ensure optimal performance to the datasheet specifications. Fairchild does not recommend exceeding them or designing to absolute maximum ratings.

| Symbol | Parameter | Rating |
|---------------|--|--------------------|
| V_{CC} | Supply Voltage Operating | 1.8V to 5.5V |
| V_{CC} | Supply Voltage Data Retention | 1.5V to 5.5V |
| V_{IN} | Input Voltage | 0V to 5.5V |
| V_{OUT} | Output Voltage | 0V to V_{CC} |
| T_A | Operating Temperature | -40°C to +85°C |
| θ_{JA} | Thermal Resistance SC70-6 Micropak-6 | 350°C/W 350°C/W |

Note:

1. Unused inputs must be held HIGH or LOW. They may not float.

DC Electrical Characteristics

| Symbol | Parameter | V _{CC} (V) | Conditions | | T _A = | | | | | Units | | |
|---------------------|---|---------------------|--|-----------------------------------|------------------------|------------------------|----------------------|----------------------|----------------------|-------|---|------|
| | | | | | +25°C | | | -40°C to +85°C | | | | |
| | | | | | Min . | Typ. | Max . | Min. | Max. | | | |
| V _{IH} | HIGH Level Input Voltage | 1.8 to 2.7 | | | 0.85 V _{CC} | | | 0.85 V _{CC} | | V | | |
| | | 3.0 to 5.5 | | | 0.8 V _{CC} | | | 0.8 V _{CC} | | | | |
| V _{IL} | LOW Level Input Voltage | 1.8 to 2.7 | | | | | 0.15 V _{CC} | | 0.15 V _{CC} | V | | |
| | | 3.0 to 5.5 | | | | | 0.2 V _{CC} | | 0.2 V _{CC} | | | |
| V _{OH} | HIGH Level Output Voltage | 1.65 | V _{IN} = V _{IL} | I _{OH} = -100μA | 1.55 | 1.65 | | 1.55 | | V | | |
| | | 1.8 | | | 1.6 | 1.79 | | 1.6 | | | | |
| | | 2.3 | | | 2.1 | 2.29 | | 2.1 | | | | |
| | | 3.0 | | | 2.7 | 2.99 | | 2.7 | | | | |
| | | 4.5 | | | 4.0 | 4.48 | | 4.0 | | | | |
| | | | 1.65 | V _{IN} = GND | I _{OH} = -2mA | 1.29 | 1.52 | | 1.29 | | V | |
| | | | 2.3 | | | I _{OH} = -2mA | 1.9 | 2.19 | | 1.9 | | |
| | | | 3.0 | | | I _{OH} = -4mA | 2.4 | 2.82 | | 2.4 | | |
| | | | 3.0 | | | I _{OH} = -6mA | 2.3 | 2.73 | | 2.3 | | |
| | | | 4.5 | | | I _{OH} = -8mA | 3.8 | 4.24 | | 3.8 | | |
| VOL | LOW Level Output Voltage | 1.65 | V _{IN} = V _{IH} | I _{OL} = 100μA | | 0.01 | 0.2 | | 0.2 | V | | |
| | | 1.8 | | | | 0.01 | 0.2 | | 0.2 | | | |
| | | 2.3 | | | | 0.01 | 0.2 | | 0.2 | | | |
| | | 3.0 | | | | 0.01 | 0.3 | | 0.3 | | | |
| | | 4.5 | | | | 0.01 | 0.5 | | 0.5 | | | |
| | | | 1.65 | V _{IN} = V _{CC} | I _{OL} = 2mA | | 0.10 | 0.24 | | 0.24 | V | |
| | | | 2.3 | | | I _{OL} = 2mA | | 0.12 | 0.3 | | | 0.3 |
| | | | 3.0 | | | I _{OL} = 4mA | | 0.19 | 0.4 | | | 0.4 |
| | | | 3.0 | | | I _{OL} = 6mA | | 0.29 | 0.55 | | | 0.55 |
| | | | 4.5 | | | I _{OL} = 8mA | | 0.29 | 0.55 | | | 0.55 |
| I _{IN} | Input Leakage Current | 0 to 5.5 | V _{IN} = 5.5V, GND | | | | ±0.1 | | ±1.0 | μA | | |
| I _{CC} | Quiescent Supply Current | 1.65 to 5.5 | V _{IN} = 5.5V, GND | | | | 1.0 | | 10 | μA | | |
| I _{CCPEAK} | Peak Supply Current in Analog Operation | 1.8 | V _{OUT} = Open V _{IN} = Adjust for Peak I _{CC} Current | | | 0.2 | | | | mA | | |
| | | 2.5 | | | | 2 | | | | | | |
| | | 3.3 | | | | 5 | | | | | | |
| | | 5.0 | | | | 15 | | | | | | |

AC Electrical Characteristics

| Symbol | Parameter | V _{CC} (V) | Conditions | T _A = | | | | | Units | Figure Number |
|-------------------------------------|-------------------------------|---------------------|--|---|------|------|----------------|------|-------|----------------------|
| | | | | +25°C | | | -40°C to +85°C | | | |
| | | | | Min. | Typ. | Max. | Min. | Max. | | |
| t _{PLH} , t _{PHL} | Propagation Delay | 1.65 | C _L = 15pF, R _L = 1MΩ | 1.5 | 5.5 | 9.8 | 1.5 | 11.0 | ns | Figure 1 Figure 3 |
| | | 1.8 | | 1.5 | 4.6 | 8.1 | 1.5 | 8.9 | | |
| | | 2.5 ± 0.2 | | 1.2 | 3.3 | 5.7 | 1.2 | 6.3 | | |
| | | 3.3 ± 0.3 | | 0.8 | 2.7 | 4.1 | 0.8 | 4.5 | | |
| | | 5.0 ± 0.5 | | 0.5 | 2.2 | 3.3 | 0.5 | 3.6 | | |
| | | 3.3 ± 0.3 | | C _L = 50pF, R _L = 500Ω | 1.2 | 4.0 | 6.4 | 1.2 | | |
| | | 5.0 ± 0.5 | 0.8 | | 3.4 | 5.6 | 0.8 | 6.2 | | |
| | | C _{IN} | Input Capacitance | 0 | | 3 | | | | pF |
| C _{PD} | Power Dissipation Capacitance | 3.3 | Note 2 | | 3.5 | | | | pF | Figure 2 |
| | | 5.0 | | | 5.5 | | | | | |

Note:

2. C_{PD} is defined as the value of the internal equivalent capacitance which is derived from dynamic operating current consumption (I_{CCD}) at no output loading and operating at 50% duty cycle. (See Figure 2.) C_{PD} is related to I_{CCD} dynamic operating current by the expression:

$$I_{CCD} = (C_{PD})(V_{CC})(f_{IN}) + (I_{CCstatic}).$$

AC Loading and Waveforms

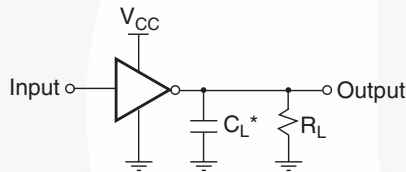

*C_L includes load and stray capacitance.
Input PRR = 1.0MHz; t_w = 500ns

Figure 1. AC Test Circuit

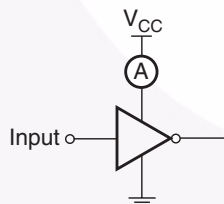

Application Note: When operating the NC7WZU04's unbuffered output stage in its linear range, as in oscillator applications, care must be taken to observe maximum power rating for the device and package. The high drive nature of the design of the output stage will result in substantial simultaneous conduction currents when the stage is in the linear region. See the I_{CCPEAK} specification on page 2.

Input = AC Waveform; t_r, t_f = 1.8ns;
PRR = 10MHz; Duty Cycle = 50%

Figure 2. I_{CCD} Test Circuit

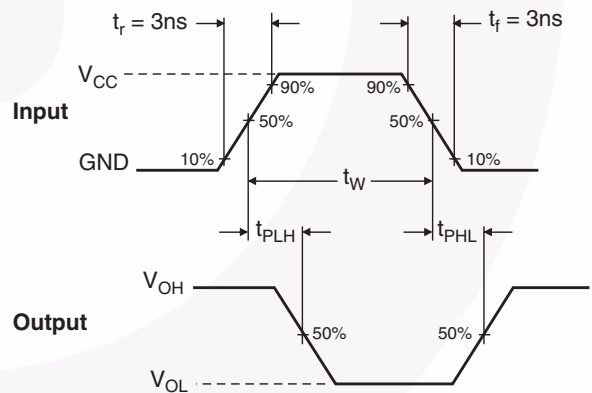

Figure 3. AC Waveforms

Tape and Reel Specification

Tape Format for SC70

| Package Designator | Tape Section | Number Cavities | Cavity Status | Cover Tape Status |
|--------------------|--------------------|-----------------|---------------|-------------------|
| P6X | Leader (Start End) | 125 (typ) | Empty | Sealed |
| | Carrier | 3000 | Filled | Sealed |
| | Trailer (Hub End) | 75 (typ) | Empty | Sealed |

Tape Dimension inches (millimeters)

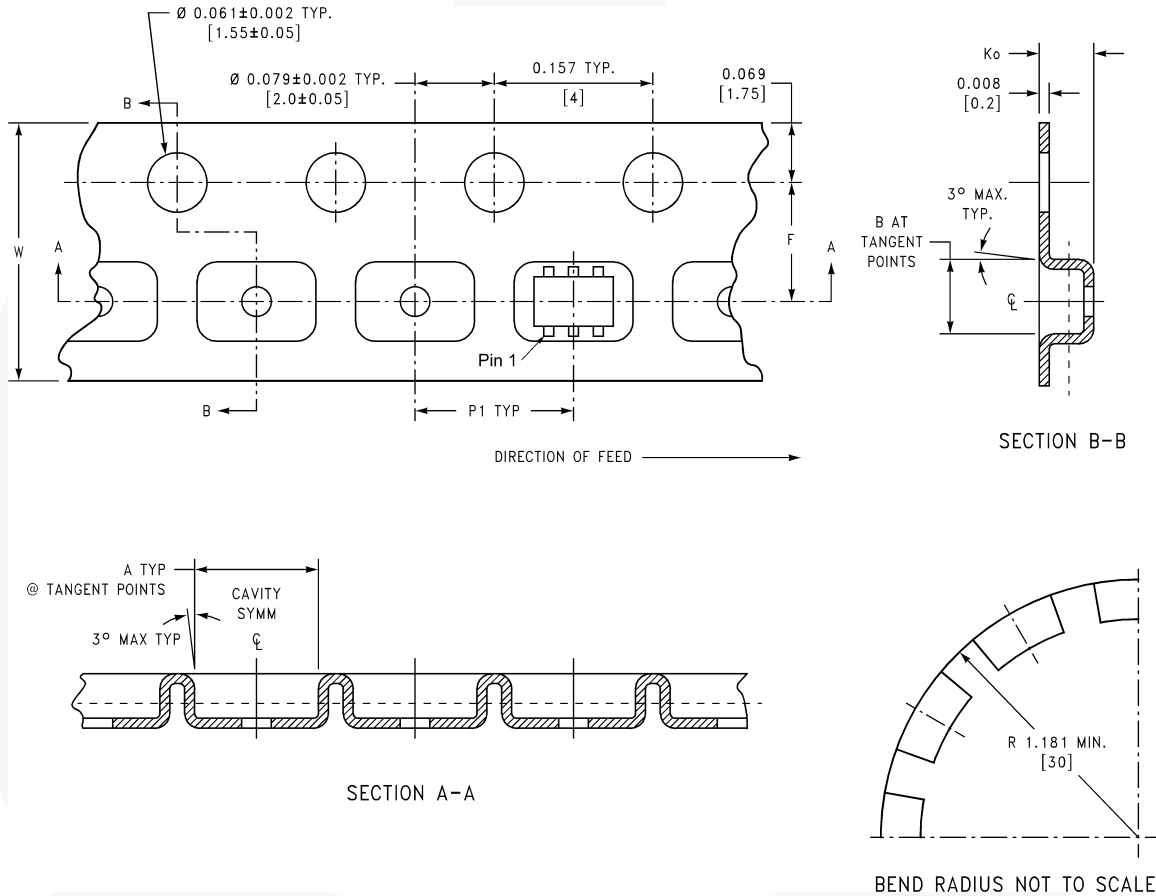

| Package | Tape Size | Dim A | Dim B | Dim F | Dim K _O | Dim P1 | Dim W |
|---------|-----------|-----------------|-----------------|-------------------------------|--------------------------------|--------------|----------------------------|
| SC70-6 | 8mm | 0.093 (2.35) | 0.096 (2.45) | 0.138 ± 0.004 (3.5 ± 0.10) | 0.053 ± 0.004 (1.35 ± 0.10) | 0.157 (4) | 0.315 ± 0.004 (8 ± 0.1) |

Tape and Reel Specification (Continued)

Tape Format for MicroPak

| Package Designator | Tape Section | Number Cavities | Cavity Status | Cover Tape Status |
|--------------------|--------------------|-----------------|---------------|-------------------|
| L6X | Leader (Start End) | 125 (typ.) | Empty | Sealed |
| | Carrier | 3000 | Filled | Sealed |
| | Trailer (Hub End) | 75 (typ) | Empty | Sealed |

Tape Dimension inches (millimeters)

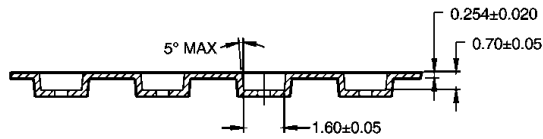
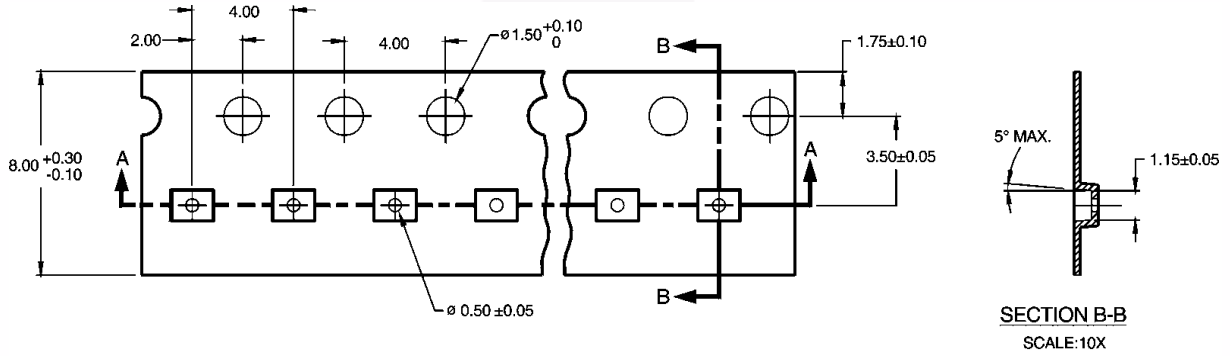

Tape and Reel Specification (Continued)

Reel Dimension for MicroPak inches (millimeters)

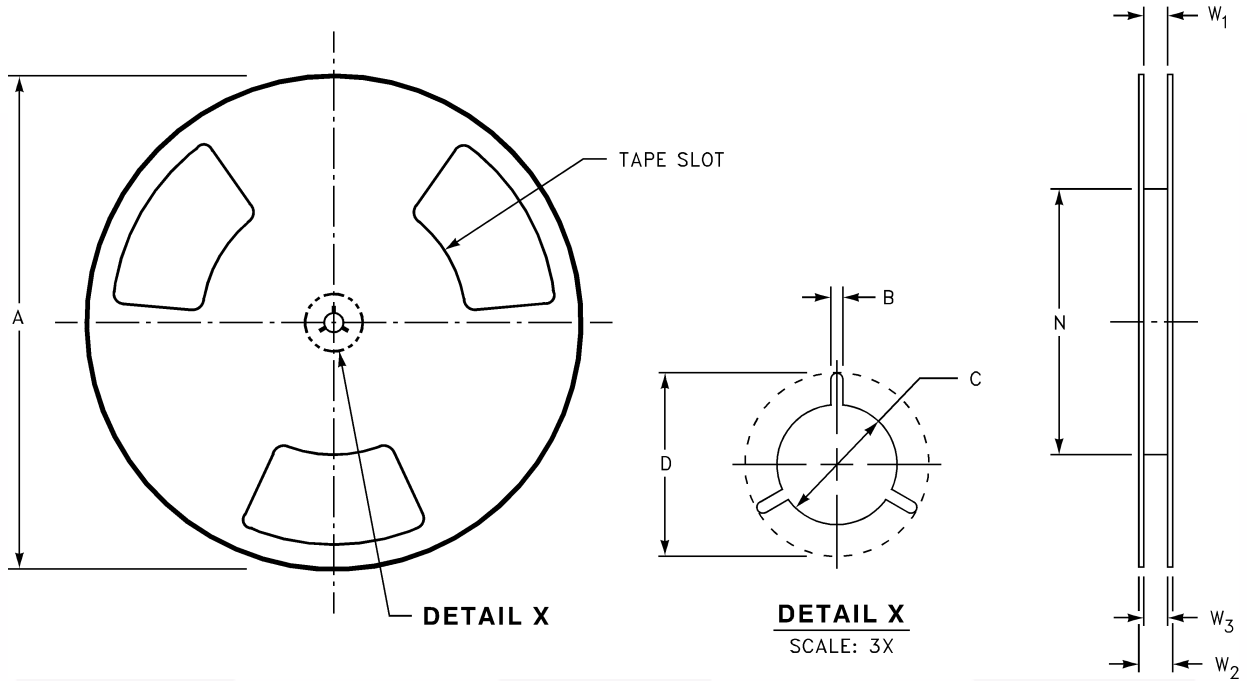

| Tape Size | A | B | C | D | N | W1 | W2 | W3 |
|-----------|----------------|-----------------|------------------|------------------|------------------|---|------------------|--|
| 8mm | 7.0 (177.8) | 0.059 (1.50) | 0.512 (13.00) | 0.795 (20.20) | 2.165 (55.00) | 0.331 + 0.059/-0.000 (8.40 + 1.50/-0.00) | 0.567 (14.40) | W1 + 0.078/-0.039 (W1 + 2.00/-1.00) |

Physical Dimensions

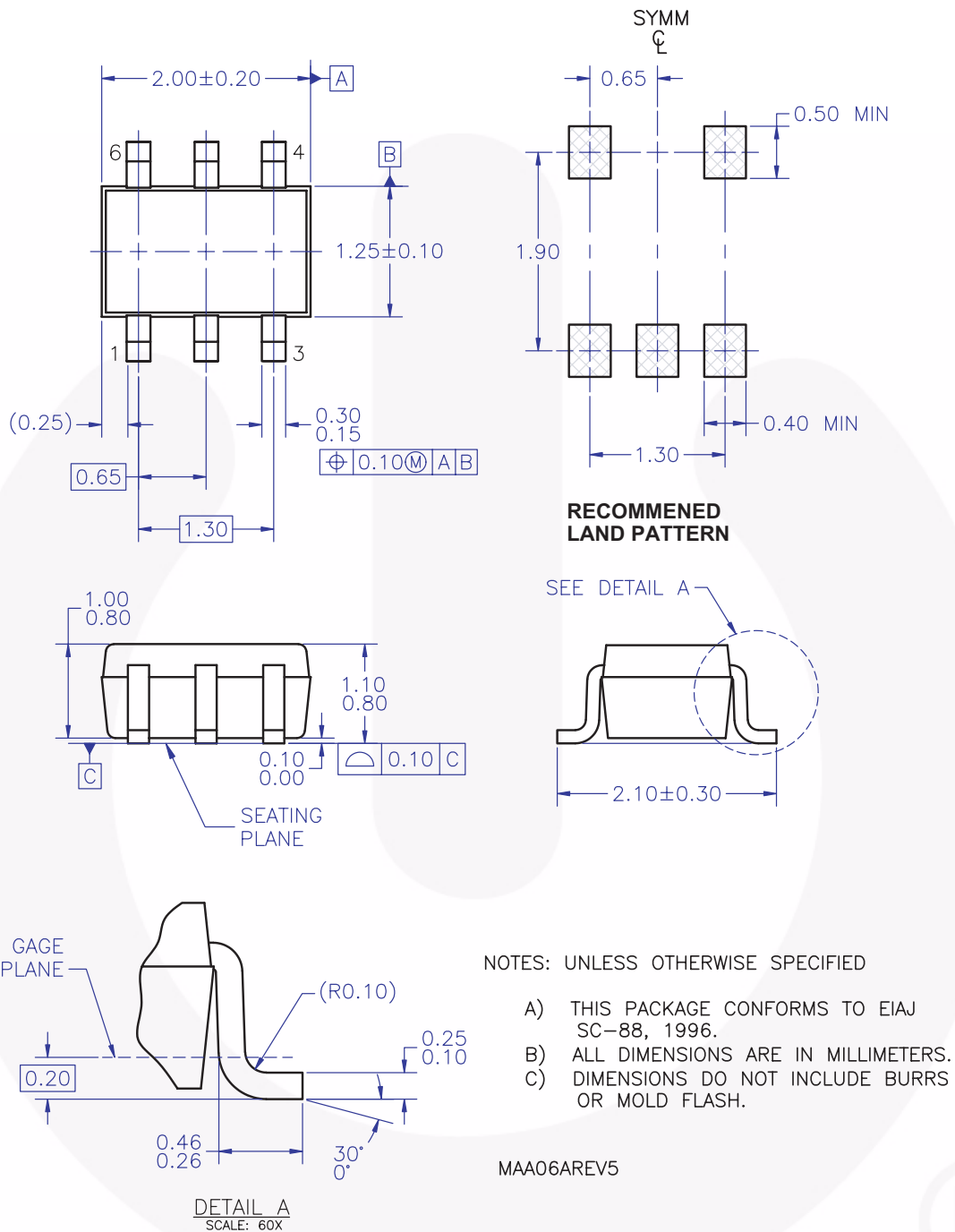

Figure 4. 6-Lead SC70, EIAJ SC88, 1.25mm Wide

Package drawings are provided as a service to customers considering Fairchild components. Drawings may change in any manner without notice. Please note the revision and/or date on the drawing and contact a Fairchild Semiconductor representative to verify or obtain the most recent revision. Package specifications do not expand the terms of Fairchild's worldwide terms and conditions, specifically the warranty therein, which covers Fairchild products.

Always visit Fairchild Semiconductor's online packaging area for the most recent package drawings:

<http://www.fairchildsemi.com/packaging/>

Physical Dimensions (Continued)

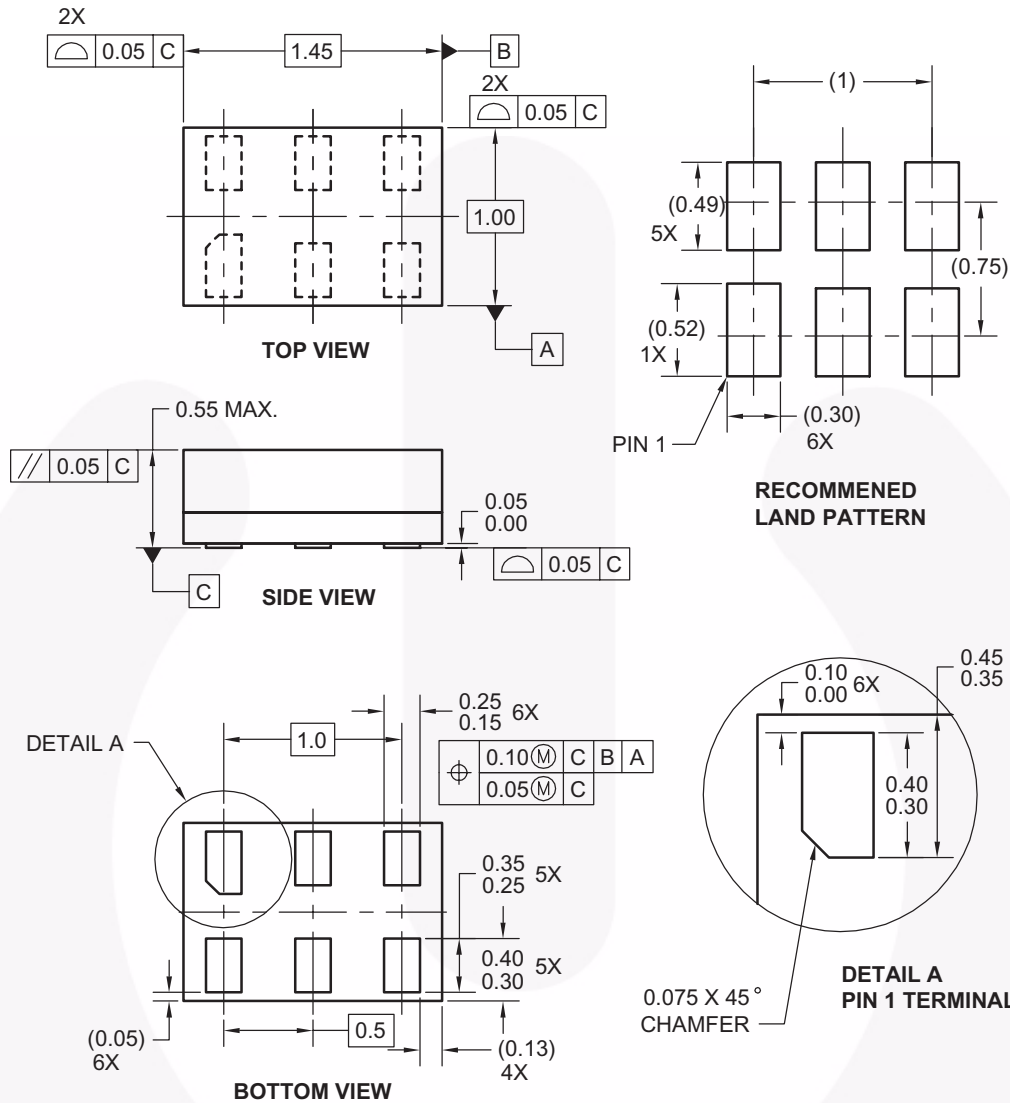

Notes:

1. CONFORMS TO JEDEC STANDARD M0-252 VARIATION UAAD
2. DIMENSIONS ARE IN MILLIMETERS
3. DRAWING CONFORMS TO ASME Y14.5M-1994

MAC06AREVC

Figure 5. 6-Lead MicroPak, 1.0mm Wide

Package drawings are provided as a service to customers considering Fairchild components. Drawings may change in any manner without notice. Please note the revision and/or date on the drawing and contact a Fairchild Semiconductor representative to verify or obtain the most recent revision. Package specifications do not expand the terms of Fairchild's worldwide terms and conditions, specifically the warranty therein, which covers Fairchild products.





Always visit Fairchild Semiconductor's online packaging area for the most recent package drawings:

<http://www.fairchildsemi.com/packaging/>



TRADEMARKS

The following includes registered and unregistered trademarks and service marks, owned by Fairchild Semiconductor and/or its global subsidiaries, and is not intended to be an exhaustive list of all such trademarks.

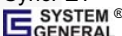
- | | | | |
|---|---|---|---|
| ACEx® | FPS™ | PDP SPM™ | The Power Franchise® |
| Build it Now™ | F-PFS™ | Power-SPM™ | the power franchise |
| CorePLUS™ | FRFET® | PowerTrench® | TinyBoost™ |
| CorePOWER™ | Global Power Resource™ | Programmable Active Droop™ | TinyBuck™ |
| CROSSVOLT™ | Green FPS™ | QFET® | TinyLogic™ |
| CTL™ | Green FPS™ e-Series™ | QS™ | TINYOPTO™ |
| Current Transfer Logic™ | GTO™ | Quiet Series™ | TinyPower™ |
| EcoSPARK® | IntelliMAX™ | RapidConfigure™ | TinyPWM™ |
| EfficientMax™ | ISOPLANAR™ | Saving our world, 1mW at a time™ | TinyWire™ |
| EZSWITCH™ * | MegaBuck™ | SmartMax™ | μSerDes™ |
|  ™ | MICROCOUPLER™ | SMART START™ |  ™ |
|  ™ | MicroFET™ | SPM® | UHC® |
| Fairchild® | MicroPak™ | STEALTH™ | Ultra FRFET™ |
| Fairchild Semiconductor® | MillerDrive™ | SuperFET™ | UniFET™ |
| FACT Quiet Series™ | MotionMax™ | SuperSOT™-3 | VCX™ |
| FACT® | Motion-SPM™ | SuperSOT™-6 | VisualMax™ |
| FAST® | OPTOLOGIC® | SuperSOT™-8 | |
| FastvCore™ | OPTOPLANAR® | SupreMOS™ | |
| FlashWriter® |  | SyncFET™ | |
| | |  | |

* EZSWITCH™ and FlashWriter® are trademarks of System General Corporation, used under license by Fairchild Semiconductor.

DISCLAIMER

FAIRCHILD SEMICONDUCTOR RESERVES THE RIGHT TO MAKE CHANGES WITHOUT FURTHER NOTICE TO ANY PRODUCTS HEREIN TO IMPROVE RELIABILITY, FUNCTION, OR DESIGN. FAIRCHILD DOES NOT ASSUME ANY LIABILITY ARISING OUT OF THE APPLICATION OR USE OF ANY PRODUCT OR CIRCUIT DESCRIBED HEREIN; NEITHER DOES IT CONVEY ANY LICENSE UNDER ITS PATENT RIGHTS, NOR THE RIGHTS OF OTHERS. THESE SPECIFICATIONS DO NOT EXPAND THE TERMS OF FAIRCHILD'S WORLDWIDE TERMS AND CONDITIONS, SPECIFICALLY THE WARRANTY THEREIN, WHICH COVERS THESE PRODUCTS.

LIFE SUPPORT POLICY

FAIRCHILD'S PRODUCTS ARE NOT AUTHORIZED FOR USE AS CRITICAL COMPONENTS IN LIFE SUPPORT DEVICES OR SYSTEMS WITHOUT THE EXPRESS WRITTEN APPROVAL OF FAIRCHILD SEMICONDUCTOR CORPORATION.

As used herein:

1. Life support devices or systems are devices or systems which, (a) are intended for surgical implant into the body or (b) support or sustain life, and (c) whose failure to perform when properly used in accordance with instructions for use provided in the labeling, can be reasonably expected to result in a significant injury of the user.
2. A critical component in any component of a life support, device, or system whose failure to perform can be reasonably expected to cause the failure of the life support device or system, or to affect its safety or effectiveness.

PRODUCT STATUS DEFINITIONS

Definition of Terms

| Datasheet Identification | Product Status | Definition |
|--------------------------|-----------------------|--|
| Advance Information | Formative / In Design | This datasheet contains the design specifications for product development. Specifications may change in any manner without notice. |
| Preliminary | First Production | This datasheet contains preliminary data; supplementary data will be published at a later date. Fairchild Semiconductor reserves the right to make changes at any time without notice to improve design. |
| No Identification Needed | Full Production | This datasheet contains final specifications. Fairchild Semiconductor reserves the right to make changes at any time without notice to improve the design. |
| Obsolete | Not In Production | This datasheet contains specifications on a product that is discontinued by Fairchild Semiconductor. The datasheet is for reference information only. |

Rev. I34

ON Semiconductor and  are trademarks of Semiconductor Components Industries, LLC dba ON Semiconductor or its subsidiaries in the United States and/or other countries. ON Semiconductor owns the rights to a number of patents, trademarks, copyrights, trade secrets, and other intellectual property. A listing of ON Semiconductor's product/patent coverage may be accessed at www.onsemi.com/site/pdf/Patent-Marking.pdf. ON Semiconductor reserves the right to make changes without further notice to any products herein. ON Semiconductor makes no warranty, representation or guarantee regarding the suitability of its products for any particular purpose, nor does ON Semiconductor assume any liability arising out of the application or use of any product or circuit, and specifically disclaims any and all liability, including without limitation special, consequential or incidental damages. Buyer is responsible for its products and applications using ON Semiconductor products, including compliance with all laws, regulations and safety requirements or standards, regardless of any support or applications information provided by ON Semiconductor. "Typical" parameters which may be provided in ON Semiconductor data sheets and/or specifications can and do vary in different applications and actual performance may vary over time. All operating parameters, including "Typicals" must be validated for each customer application by customer's technical experts. ON Semiconductor does not convey any license under its patent rights nor the rights of others. ON Semiconductor products are not designed, intended, or authorized for use as a critical component in life support systems or any FDA Class 3 medical devices or medical devices with a same or similar classification in a foreign jurisdiction or any devices intended for implantation in the human body. Should Buyer purchase or use ON Semiconductor products for any such unintended or unauthorized application, Buyer shall indemnify and hold ON Semiconductor and its officers, employees, subsidiaries, affiliates, and distributors harmless against all claims, costs, damages, and expenses, and reasonable attorney fees arising out of, directly or indirectly, any claim of personal injury or death associated with such unintended or unauthorized use, even if such claim alleges that ON Semiconductor was negligent regarding the design or manufacture of the part. ON Semiconductor is an Equal Opportunity/Affirmative Action Employer. This literature is subject to all applicable copyright laws and is not for resale in any manner.

PUBLICATION ORDERING INFORMATION

LITERATURE FULFILLMENT:

Literature Distribution Center for ON Semiconductor
19521 E. 32nd Pkwy, Aurora, Colorado 80011 USA
Phone: 303-675-2175 or 800-344-3860 Toll Free USA/Canada
Fax: 303-675-2176 or 800-344-3867 Toll Free USA/Canada
Email: orderlit@onsemi.com

N. American Technical Support: 800-282-9855 Toll Free
USA/Canada
Europe, Middle East and Africa Technical Support:
Phone: 421 33 790 2910
Japan Customer Focus Center
Phone: 81-3-5817-1050

ON Semiconductor Website: www.onsemi.com
Order Literature: <http://www.onsemi.com/orderlit>
For additional information, please contact your local
Sales Representative

Mouser Electronics

Authorized Distributor

Click to View Pricing, Inventory, Delivery & Lifecycle Information:

[ON Semiconductor:](#)

[NC7WZU04P6](#) [NC7WZU04P6X](#) [NC7WZU04L6X](#)

Компания «Океан Электроники» предлагает заключение долгосрочных отношений при поставках импортных электронных компонентов на взаимовыгодных условиях!

Наши преимущества:

- Поставка оригинальных импортных электронных компонентов напрямую с производств Америки, Европы и Азии, а так же с крупнейших складов мира;
- Широкая линейка поставок активных и пассивных импортных электронных компонентов (более 30 млн. наименований);
- Поставка сложных, дефицитных, либо снятых с производства позиций;
- Оперативные сроки поставки под заказ (от 5 рабочих дней);
- Экспресс доставка в любую точку России;
- Помощь Конструкторского Отдела и консультации квалифицированных инженеров;
- Техническая поддержка проекта, помощь в подборе аналогов, поставка прототипов;
- Поставка электронных компонентов под контролем ВП;
- Система менеджмента качества сертифицирована по Международному стандарту ISO 9001;
- При необходимости вся продукция военного и аэрокосмического назначения проходит испытания и сертификацию в лаборатории (по согласованию с заказчиком);
- Поставка специализированных компонентов военного и аэрокосмического уровня качества (Xilinx, Altera, Analog Devices, Intersil, Interpoint, Microsemi, Actel, Aeroflex, Peregrine, VPT, Syfer, Eurofarad, Texas Instruments, MS Kennedy, Miteq, Cobham, E2V, MA-COM, Hittite, Mini-Circuits, General Dynamics и др.);

Компания «Океан Электроники» является официальным дистрибьютором и эксклюзивным представителем в России одного из крупнейших производителей разъемов военного и аэрокосмического назначения «**JONHON**», а так же официальным дистрибьютором и эксклюзивным представителем в России производителя высокотехнологичных и надежных решений для передачи СВЧ сигналов «**FORSTAR**».



JONHON

«**JONHON**» (основан в 1970 г.)

Разъемы специального, военного и аэрокосмического назначения:

(Применяются в военной, авиационной, аэрокосмической, морской, железнодорожной, горно- и нефтедобывающей отраслях промышленности)

«**FORSTAR**» (основан в 1998 г.)

ВЧ соединители, коаксиальные кабели,
кабельные сборки и микроволновые компоненты:

(Применяются в телекоммуникациях гражданского и специального назначения, в средствах связи, РЛС, а так же военной, авиационной и аэрокосмической отраслях промышленности).



Телефон: 8 (812) 309-75-97 (многоканальный)

Факс: 8 (812) 320-03-32

Электронная почта: ocean@oceanchips.ru

Web: <http://oceanchips.ru/>

Адрес: 198099, г. Санкт-Петербург, ул. Калинина, д. 2, корп. 4, лит. А