

# ISDN S-Interface Transformers

Surface Mount, Dual, 2000 Vrms

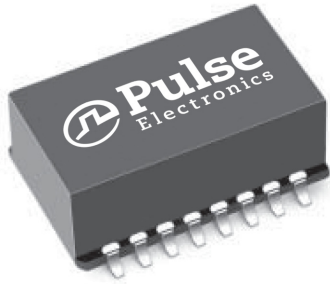

- Meets pulse waveform template of CCITT I.430 when recommended transformer and chip pair are used
- Excellent longitudinal balance
- 2kVrms isolation voltage
- Available in tape and reel, tray or tube packaging
- Recognized by UL

Electrical Specifications @ 25°C - Operating Temperature 0°C to +70°C

Part Number	Ratio (±2%)		OCL Pri (mH MIN)	L <sub>L</sub> Sec (μH MAX)		Cw/w (pF MAX)	CD Pri (pF MAX)		DCR Pri (Ω ±25%)		DCR Sec (Ω ±25%)		Δ Ibc <sup>c</sup> (mA MAX)	Package / Schematic
	A	B	A & B	A	B	A & B	A	B	A	B	A	B		
PE-65793	1:1	1:1	22	5	5	100	42	42	2.4	2.4	2.4	2.4	1	SC-1
PE-65795	1:2	1:2	22	15	15	100	80	80	4.3	4.3	4.3	4.3	1	SC-1

## Mechanical

## Schematic

SC-1

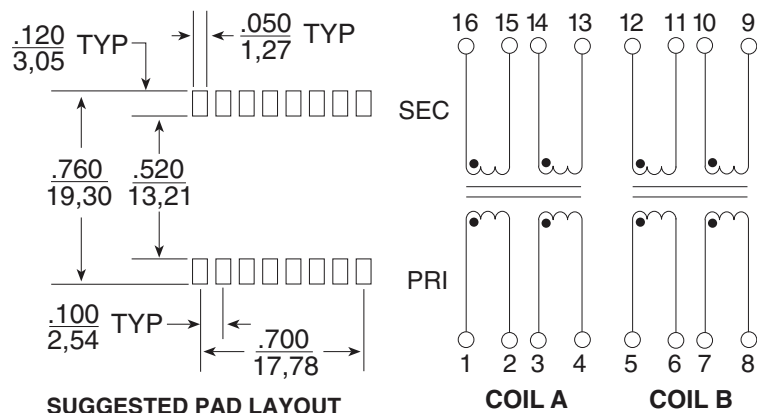
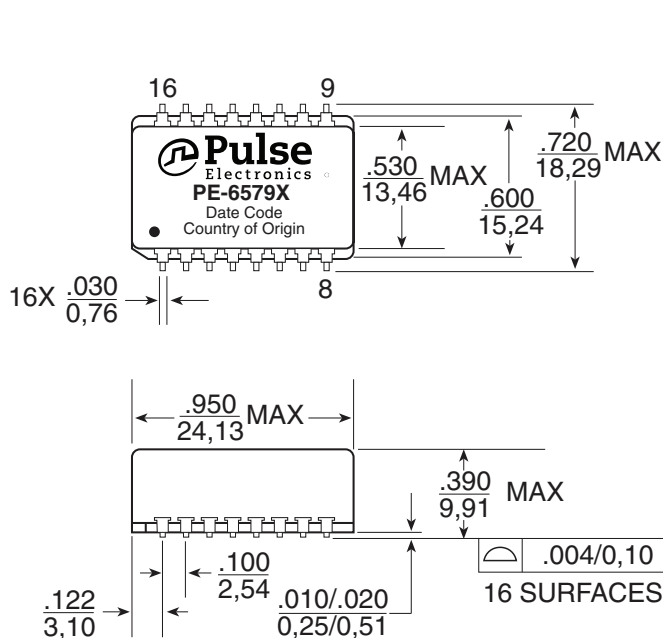

SUGGESTED PAD LAYOUT

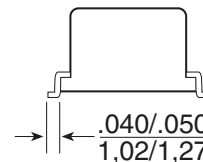

Dimensions:  $\frac{\text{Inches}}{\text{mm}}$

Unless otherwise specified, all tolerances are  $\pm \frac{.010}{0,25}$

USA 858 674 8100

Germany 49 7032 7806 0

Singapore 65 6287 8998

Shanghai 86 21 62787060

China 86 755 33966678

Taiwan 886 3 4356768

# ISDN S-Interface Transformers

Through Hole, Single & Dual, 2000 Vrms

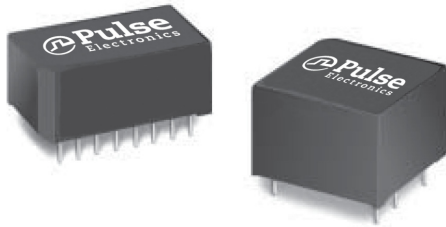

- Meets pulse waveform template of CCITT I.430 when recommended transformer and chip pair are used
- Excellent longitudinal balance
- 2kVrms isolation voltage
- Recognized by UL

## Electrical Specifications @ 25°C - Operating Temperature 0°C to +70°C

### 2kV Isolation, Through Hole, Single Transformers

Part Number	Ratio (±2%)	OCL Pri (mH MIN)	L <sub>L</sub> Sec (μH MAX)	C <sub>w/w</sub> (pF MAX)	CD Pri (pF MAX)	DCR Pri (Ω ±25%)	DCR Sec (Ω ±25%)	Isolation (VRMS MIN)	ΔI <sub>cc</sub> (mA MAX)	Package / Schematic
PE-64995NL	1CT:2CT	22	15	100	80	2.5	4.3	2000	1	SC-1

### Mechanical

### Schematic

#### IS-1

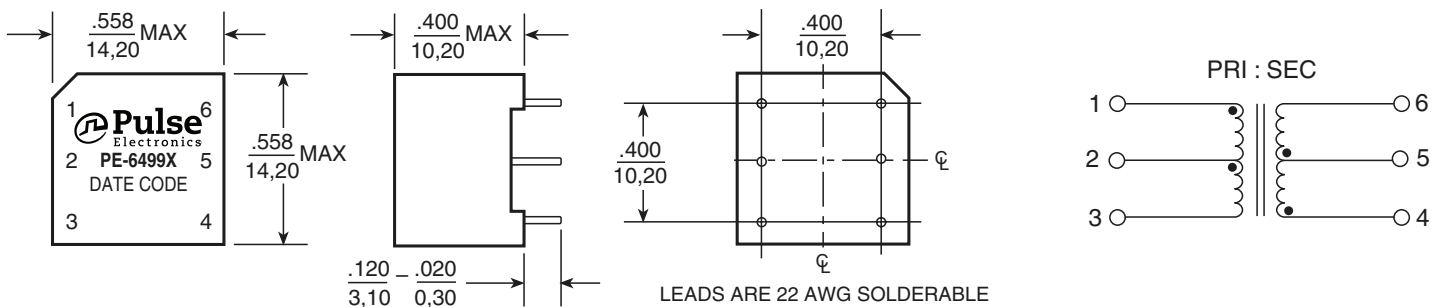

## Electrical Specifications @ 25°C - Operating Temperature -40°C to +125°C

Part Number	Turns Ratio				DCR (mΩ MAX)				Package / Schematic
	Ratio <sup>A</sup>	Equivalent Single	Primary Pins	Secondary Pins	Ratio <sup>A</sup>	Equivalent Single	Primary Pins	Secondary Pins	
PE-65495NL	1:2	1-4	1-4	16-13	1:2	PE-64995NL	5-8	12-9	ID-1

### Mechanical

### Schematic

#### ID-1

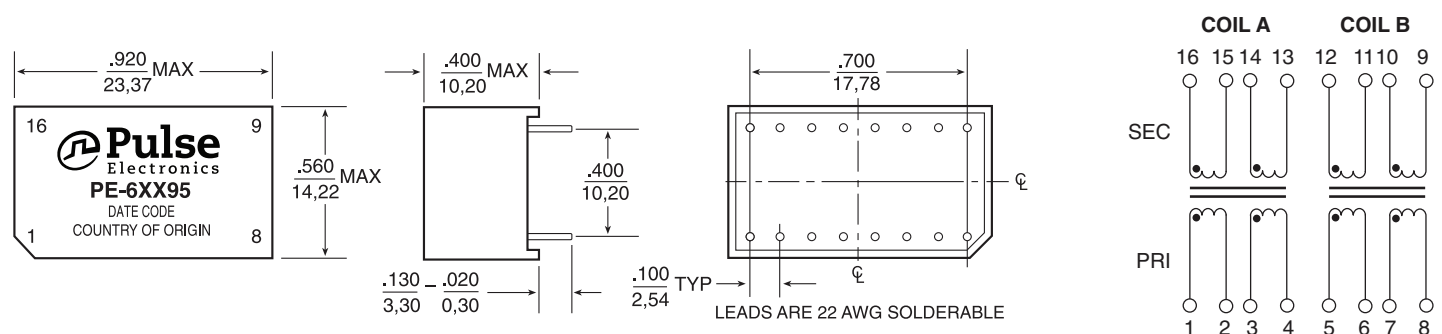

# ISDN S-Interface Transformers

Transformer Selection & Packaging

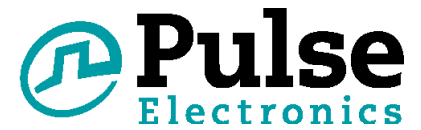

IC Manufacturer	IC Part Number	Dual Surface Mount	Single Through Hole, 2 kVRMS		Dual Through Hole
		TX & RX	TX	RX	TX & RX
AT&T/Lucent	T7903	PE-65795	PE-64995NL	PE-64995NL	PE-65495
Mietec	MTC-2072	PE-65795	PE-64995NL	PE-64995NL	PE-65495
Mitel	MT8930	PE-65795	PE-64995NL	PE-64995NL	PE-65495
Motorola	MC145474/145475 MC145574	PE-65795	-	-	PE-65495
National <sup>D</sup>	TP3420/34221	PE-65795	PE-64995NL	PE-64995NL	PE-65495
SGS Thomson	ST5420, ST5421	PE-65795	PE-64995NL	PE-64995NL	PE-65495
Siemens	PEB 2080/2081/2085 PSB 2186 PEB 2084/2086	PE-65795	PE-64995NL	PE-64995NL	PE-65495
Yamaha	7405B	PE-65795	PE-64995NL	PE-64995NL	PE-65495

## Notes:

- A. In this catalog, turns ratio is expressed as “primary:secondary”. The term “CT” designates a center tapped winding. A center tapped winding can be created by connecting two ends of a split center winding together on the printed circuit board. In ISDN-S applications, the primary winding is the line side transformer winding.
- B. The minimum primary inductance and the maximum distributed capacitance satisfy the transmitter output and receiver input impedance requirements of CCITTI I.430 for both the TE and the NT. The maximum distributed capacitance allows sufficient margin for the capacitance of the IC and a protection diode network. It is consistent with the overall maximum value specified and the permitted length of the basic access TE cord.
- C. The maximum specified unbalanced DC current capability is based on 20 mH minimum primary OCL
- D. National recommends a 1:2 receive transformer, but used as a 1:1 ratio by connectin only half the secondary winding. See National's application note.
- E. PE-65950 and PE-65853 are recommended for use with Siemens PEB 2080/2085 and help in meeting the required longitudinal balance.
- F. Standard packaging for all chokes and transformers listed in this catalog is anti-static tubes. Optional anti-static tray packaging can be ordered for the surface mount SC-1 and LA-1 packages by adding an “R” suffix to the part number, (ie: PE-65795R). Optional tape and reel packaging can be ordered for all surface mount packages by adding a “T” suffix to the part number, (ie: PE-65795T).
- G. For PE-65854, OCL at -40C is 27 H minimum. For maximum performance, using windings (1-8) and (2-7) as a pair and windings (3-6) and (4-5) as a pair.
- H. For transformers and choke modules, refer to data sheet T632.

Packaging Information								
Package <sup>F</sup>	Type	Part Weight	Parts/Tube	Parts/Tray	Parts/Reel	Reel Diameter	Tape Width	Pitch
LA-1	SMT	2.0 Grams	30	60	250	13 Inches	24 mm	24 mm
SC-1	SMT	7.0 Grams	20	50	150	13 Inches	44 mm	24 mm
ID-1	THT	7.0 Grams	20	-	-	-	-	-
IS-1	THT	4.0 Grams	35	-	-	-	-	-

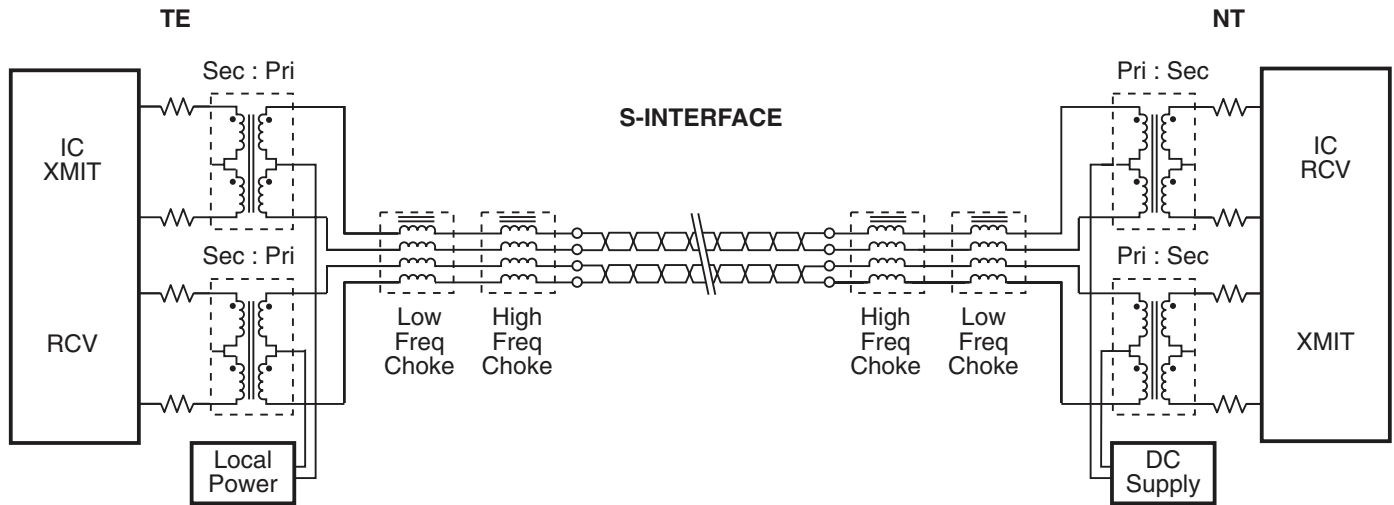

**Figure 1. Typical ISDN S-Interface Application Circuit**

**1. General Information** - The S-interface is the standardized four-wire digital telephone access point defined by the CCITT I-series recommendations for the Integrated Services Digital Network. This “basic rate access” accommodates two 64Kpbs “B-channels” for information, one 16Kpbs “D-channel” intended for signaling and control, and 48 Kbps for framing and other purposes, giving a total rate of 192Kbps. The CCITT physical layer recommends that the user network interface be transformer coupled. A typical application circuit is presented in Figure 1.

The transformer provides isolation for the line card or the terminal from the line. It is also a way to provide phantom power feeding to the terminal over the S-loop. Each end requires a transmit and a receive transformer. Chokes are used in some applications to reduce common mode noise (see note 5).

The transformers described in this data sheet are matched to the transceivers offered by the major IC manufacturers listed. The use of a transformer-chip pair assures that all requirements of CCITT I.430 are met with respect to pulse waveform templates, impedance and longitudinal balance. In addition, the transformers provide the isolation voltages required by the regulatory agencies and are capable of passing surge voltage tests.

**2. Longitudinal Balance for Transformers** - The longitudinal conversion loss specification in I.430 includes a test setup that is intended for system evaluation, whether TE or NT. Such a test is performed with DC current present. The transformer plays an essential role in achieving the required balance. However, all other elements in the circuit should be also designed to provide the highest possible symmetry. These elements include the protection circuitry, series resistors, chip transmitter output and receiver input, as well as the cables used and the TE cord where applicable. A high level of transformer balance compensates for some circuit AC-unbalance, and assures compliances of the system with I.430 on longitudinal conversion loss (LCL) and signal balance. This is accomplished by a well AC-balanced winding configuration whereby the capacitive coupling between primary and secondary windings is evenly distributed. Also, both halves of the lineside winding are well balanced. The transformers meet the following LCL specifications:

- 10kHz to 300kHz: 60dB minimum
- 300kHz to 1MHz: Minimum value decreasing 20dB/decade.

*(continued on next page)*

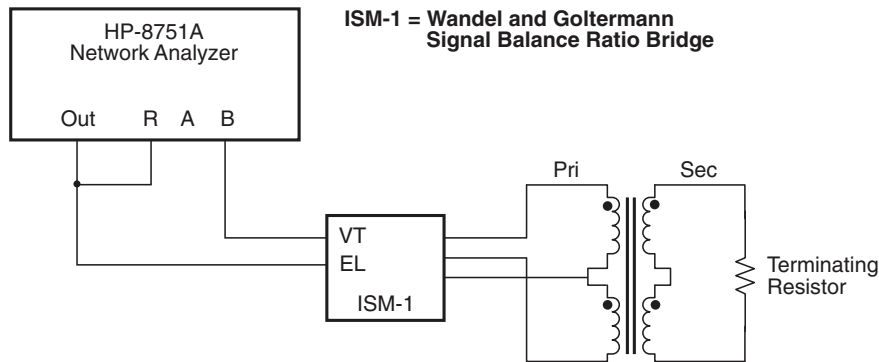

**Figure 2. Longitudinal Balance Test Circuit**

**2.** (continued from previous page) A recommended test set up is shown in Figure 2. A high inductance “low frequency” is common mode choke, such as PE-65950NL or PE-65853NL, is recommended to improve balance, or to correct inherent unbalances of some circuits.

**3. Impedance Requirements** - The requirements for minimum impedance in the inactive and powered-down states are expressed by impedance templates for both transmitter and receiver in NT and TE. At the low frequency end of 1MHz, it is reasonable to assume that the impedance seen from the line is entirely capacitive. The maximum capacitance budget, derived from the templates, is somewhat different for the NT and the TE. Contributors to the total capacitance are: the chip output, the protection circuit, the transformer, common mode choke, and any other element that may be present. In the TE case, there is also the maximum allowable TE cord impedance. Here the maximum budget is 800pF. As a rule, the capacitances should be kept as low as possible in the interface circuit design. With the specified transformer capacitances, it is possible to remain within budget and have a reasonable margin for measurement errors.

**4. Common Mode Chokes** - The “high frequency” 4-wire common mode chokes shown on pages 7 and 8 provide an effective means of compliance with national

and international regulations on EMI. They are designed to be used in conjunction with either Pulse’s ISDN S-Interface or T1/CEPT transformers as shown in Figure 1. A high inductance “low frequency” common mode choke is recommended to improve balance, or to correct inherent unbalances of some ISDN S-Interface circuits.

**5. Surge Voltage Capability for Transformers and Chokes**

- Longitudinal Voltage Peak: 2,400V 10/700µsec
- Metallic Voltage Peak: 800V 10/560µsec

**6. Behavior Under Fault Conditions** - Telephony voltages may accidentally appear on the ISDN S-Interface line to the transformer. The transformer will withstand a DC current of 0.5 Amps for 15 minutes without permanent damage. Such current may be caused by the telephone central battery. The transformer will also survive ringing voltages. These are nominally 120V or 200V maximum at 20 to 60Hz, limited by 1500W resistive or 400 to 600W inductive limiting. These may cause peak currents.

**7. Flammability** - Materials used in the products are recognized UL94-VO. Products meet the requirements of IEC 695-2-2 (Needle Flame Test).

# ISDN S-Interface Transformers

Common Mode Chokes for Telecom Applications

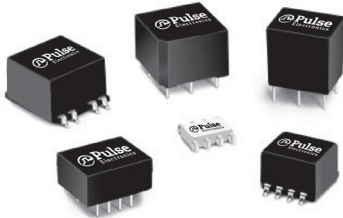

- Ⓢ Designed for 4-wire links, ISDN-S/T and T1/E1/CEPT
- Ⓢ High frequency chokes for EMI reduction
- Ⓢ Low frequency chokes improve longitudinal balance in ISDN-S/T links
- Ⓢ Surface mount and through hole models available

## Electrical Specifications @ 25°C - Operating Temperature 0°C to +70°C

Part Number	OCL Pri (mH MIN)	L <sub>L</sub> Sec (μH MAX)	Cw/w (pF MAX)	DCR (W MAX)	Isolation (VRMS MIN)	Package / Schematic
<b>Low Frequency</b>						
PE-65853NL <sup>E</sup>	4.7 mH ±30%	1	60	1.20	500	PA-2/5C (Surface Mount)
PE-65950NL <sup>E</sup>	4.7 mH ±30%	1	50	1.00	500	IS-4/1C (Through Hole)
<b>High Frequency</b>						
PE-65554NL	24.0 μH MIN	.20	15	0.30	500	IN-1/C (Through Hole)
PE-65854NL <sup>F</sup>	47.0 μH MIN	.18	20	0.40	50	SH-4/C (Surface Mount)
PE-65857NL	22.5 μH MIN	.23	17	0.30	500	LA-1/C (Surface Mount)

Typical common mode attenuation for low frequency common mode chokes based on a 100 system.

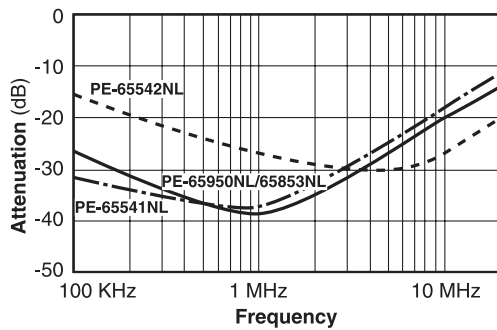

Typical impedance for low frequency common mode chokes based on a 100 system.

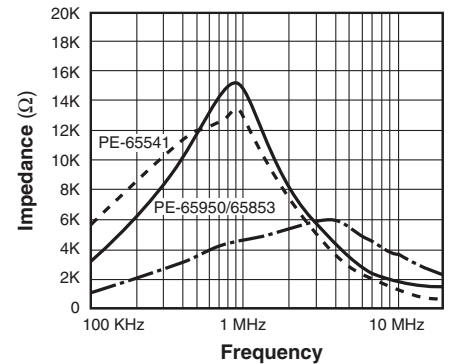

Typical common mode attenuation for high frequency common mode chokes based on a 100 system.

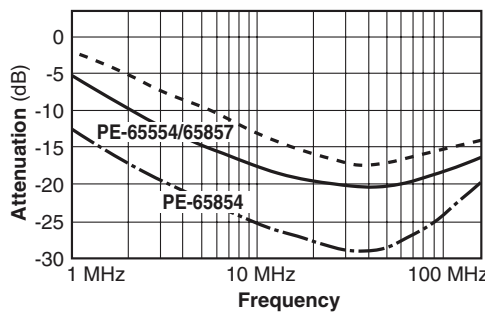

Typical impedance for high frequency common mode chokes based on a 100 system.

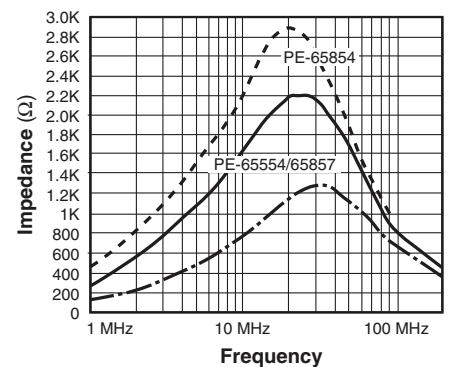

# ISDN S-Interface Transformers

Common Mode Chokes for Telecom Applications

## Mechanicals

IN-1

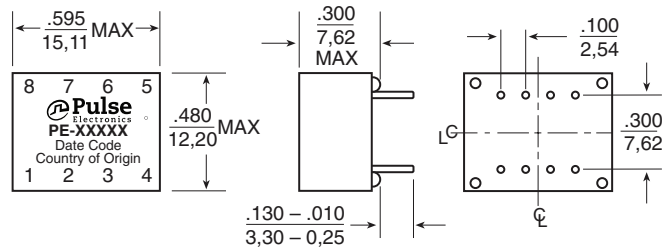

SH-4

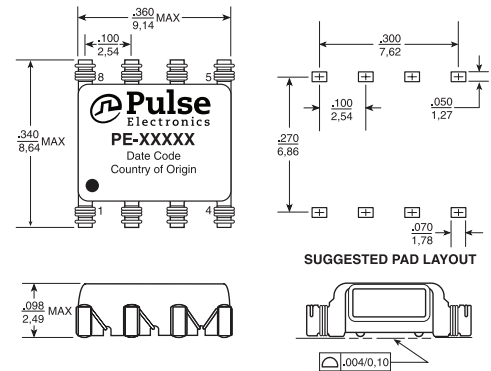

IN-4

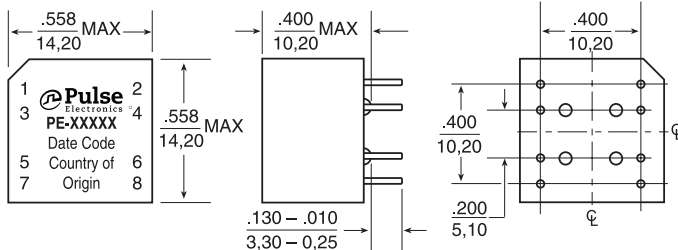

PA-2

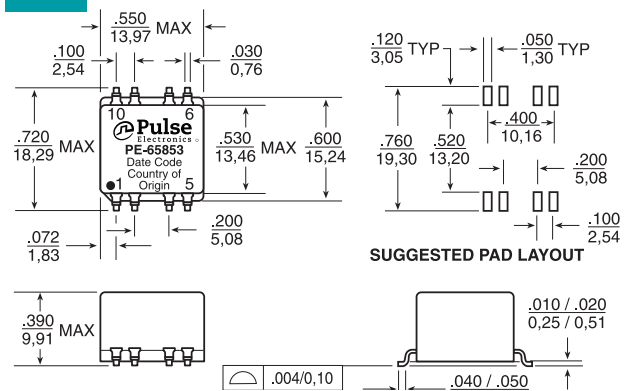

IN-1

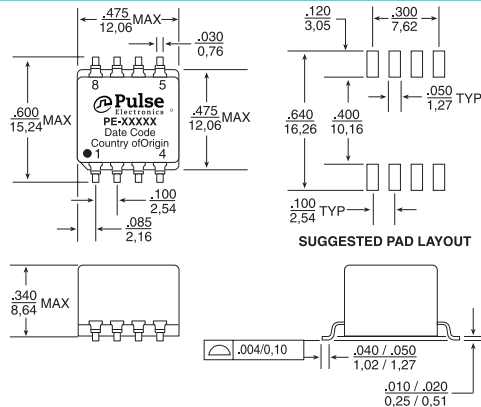

## Schematics

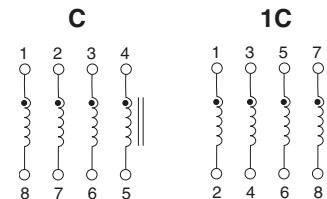

1. Dimensions: Inches / mm Unless otherwise specified, all tolerances are  $\pm \frac{.010}{0,25}$

2. See page 3 for packaging information.

## For More Information

**Pulse Worldwide Headquarters**  
 12220 World Trade Drive  
 San Diego, CA  
 92128  
 U.S.A.

**Pulse Europe**  
 Einsteinstrasse 1  
 D-71083 Herrenberg  
 Germany  
 Tel: 49 7032 78060  
 Fax: 49 7032 7806 135

**Pulse China Headquarters**  
 B402, Shenzhen Academy of  
 Aerospace Technol-  
 ogy Bldg.  
 10th Kejianan Road  
 High-Tech Zone  
 Nanshan District  
 Shenzhen, PR China  
 518057  
 Tel: 86 755 3396678  
 Fax: 86 755 33966700

**Pulse North China**  
 Room 2704/2705  
 Super Ocean Finance  
 Ctr.  
 2067 Yan An Road  
 West  
 Shanghai 200336  
 China  
 Tel: 86 21 62787060  
 Fax: 86 2162786973

**Pulse South Asia**  
 135 Joo Seng Road  
 #03-02  
 PM Industrial Bldg.  
 Singapore 368363  
 Tel: 65 6287 8998  
 Fax: 65 6287 8998

**Pulse North Asia**  
 3F, No. 198  
 Zhongyuan Road  
 Zhongli City  
 Taoyuan County 320  
 Taiwan R. O. C.  
 Tel: 886 3 4356768  
 Fax: 886 3 4356823 (Pulse)  
 Fax: 886 3 4356820 (FRE)

Performance warranty of products offered on this data sheet is limited to the parameters specified. Data is subject to change without notice. Other brand and product names mentioned herein may be trademarks or registered trademarks of their respective owners. © Copyright, 2012. Pulse Electronics, Inc. All rights reserved.



Компания «Океан Электроники» предлагает заключение долгосрочных отношений при поставках импортных электронных компонентов на взаимовыгодных условиях!

Наши преимущества:

- Поставка оригинальных импортных электронных компонентов напрямую с производств Америки, Европы и Азии, а так же с крупнейших складов мира;
- Широкая линейка поставок активных и пассивных импортных электронных компонентов (более 30 млн. наименований);
- Поставка сложных, дефицитных, либо снятых с производства позиций;
- Оперативные сроки поставки под заказ (от 5 рабочих дней);
- Экспресс доставка в любую точку России;
- Помощь Конструкторского Отдела и консультации квалифицированных инженеров;
- Техническая поддержка проекта, помощь в подборе аналогов, поставка прототипов;
- Поставка электронных компонентов под контролем ВП;
- Система менеджмента качества сертифицирована по Международному стандарту ISO 9001;
- При необходимости вся продукция военного и аэрокосмического назначения проходит испытания и сертификацию в лаборатории (по согласованию с заказчиком);
- Поставка специализированных компонентов военного и аэрокосмического уровня качества (Xilinx, Altera, Analog Devices, Intersil, Interpoint, Microsemi, Actel, Aeroflex, Peregrine, VPT, Syfer, Eurofarad, Texas Instruments, MS Kennedy, Miteq, Cobham, E2V, MA-COM, Hittite, Mini-Circuits, General Dynamics и др.);

Компания «Океан Электроники» является официальным дистрибьютором и эксклюзивным представителем в России одного из крупнейших производителей разъемов военного и аэрокосмического назначения «JONHON», а так же официальным дистрибьютором и эксклюзивным представителем в России производителя высокотехнологичных и надежных решений для передачи СВЧ сигналов «FORSTAR».



## JONHON

«JONHON» (основан в 1970 г.)

Разъемы специального, военного и аэрокосмического назначения:

(Применяются в военной, авиационной, аэрокосмической, морской, железнодорожной, горно- и нефтедобывающей отраслях промышленности)

«FORSTAR» (основан в 1998 г.)

ВЧ соединители, коаксиальные кабели, кабельные сборки и микроволновые компоненты:

(Применяются в телекоммуникациях гражданского и специального назначения, в средствах связи, РЛС, а так же военной, авиационной и аэрокосмической отраслях промышленности).



Телефон: 8 (812) 309-75-97 (многоканальный)

Факс: 8 (812) 320-03-32

Электронная почта: [ocean@oceanchips.ru](mailto:ocean@oceanchips.ru)

Web: <http://oceanchips.ru/>

Адрес: 198099, г. Санкт-Петербург, ул. Калинина, д. 2, корп. 4, лит. А