



Spatter-resistant Fluororesin-coated Proximity Sensor

- Superior spatter resistance.
- Long Sensing-distance Models added for sensing distances up to 15 mm.
- Pre-wired Smartclick Connector Models are also available.



Be sure to read *Safety Precautions* on page 6.

For the most recent information on models that have been certified for safety standards, refer to your OMRON website.

Ordering Information

Sensors [Refer to *Dimensions* on page 7.]

Pre-wired Models

Long Sensing-distance Models

Appearance	Sensing distance	Output configuration	Operation mode	Model
Shielded 	M12 4 mm	DC 2-wire (no polarity)	NO	E2EQ-X4X1 2M
	M18 8 mm			E2EQ-X8X1 2M
	M30 15 mm			E2EQ-X15X1 2M

Standard Models

Appearance	Sensing distance	Output configuration	Operation mode	Model
Shielded 	M12 3 mm	DC 2-wire	NO	E2EQ-X3D1 2M
	M18 7 mm			E2EQ-X7D1 2M
	M30 10 mm			E2EQ-X10D1 2M

Pre-wired Smartclick Connector Models (M12)

Long Sensing-distance Models





Appearance	Sensing distance	Output configuration	Operation mode	Model
Shielded 	M12 4 mm	DC 2-wire (no polarity) (3)-(4) pin arrangement	NO	E2EQ-X4X1-M1TJ 0.3M
	M18 8 mm			E2EQ-X8X1-M1TJ 0.3M
	M30 15 mm			E2EQ-X15X1-M1TJ 0.3M

Standard Models



Standard Models	Sensing distance	Output configuration	Operation mode	Model
Shielded 	M12 3 mm	DC 2-wire (1)-(4) pin arrangement	NO	E2EQ-X3D1-M1TGJ 0.3M
	M18 7 mm			E2EQ-X7D1-M1TGJ 0.3M
	M30 10 mm			E2EQ-X10D1-M1TGJ 0.3M

Pre-wired Connector Models (M12)

Long Sensing-distance Models

Appearance		Sensing distance	Output configuration	Operation mode	Model
Shielded 	M12	 4 mm	DC 2-wire (without polarity) (3)-(4) pin arrangement	NO	E2EQ-X4X1-M1J 0.3M
	M18	 8 mm			E2EQ-X8X1-M1J 0.3M
	M30	 15 mm			E2EQ-X15X1-M1J 0.3M

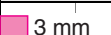



Standard Models

Standard Models		Sensing distance	Output configuration	Operation mode	Model
Shielded 	M12	 3 mm	DC 2-wire (1)-(4) pin arrangement	NO	E2EQ-X3D1-M1GJ 0.3M
	M18	 7 mm			E2EQ-X7D1-M1GJ 0.3M
	M30	 10 mm			E2EQ-X10D1-M1GJ 0.3M

Accessories (Order Separately)

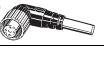
Sensor I/O Connectors (M12, Sockets on One Cable End)

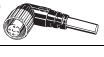
(Models with Pre-wired Connectors: A Connector is not provided with the Sensor. Be sure to order a Connector separately.) [Refer to XS2, XS5.]

Appearance	Cable length	Sensor I/O Connector model number	Applicable Proximity Sensor model number
Straight 	2 m	XS2F-D421-DC0-F	E2EQ-X□X1-M1J
	5 m	XS2F-D421-GC0-F	
L-shape 	2 m	XS2F-D422-DC0-F	
	5 m	XS2F-D422-GC0-F	
Straight 	2 m	XS2F-D421-DA0-F	E2EQ-X□D1-M1GJ
	5 m	XS2F-D421-GA0-F	
L-shape 	2 m	XS2F-D422-DA0-F	
	5 m	XS2F-D422-GA0-F	
Smartclick Connector Straight 	2 m	XS5F-D421-D80-F	E2EQ-X□X1-M1TJ E2EQ-X□D1-M1TGJ
	5 m	XS5F-D421-G80-F	

Note: Refer to *Introduction to Sensor I/O Connectors* for details.

Ratings and Specifications

Long Sensing-distance Models

Item	Model	E2EQ-X4X1 E2EQ-X4X1-M1(T)J	E2EQ-X8X1 E2EQ-X8X1-M1(T)J	E2EQ-X15X1 E2EQ-X15X1-M1(T)J
Sensing distance		4 mm ±10%	8 mm ±10%	15 mm ±10%
Set distance *1		0 to 3.2 mm	0 to 6.4 mm	0 to 12 mm
Differential travel		15% max. of sensing distance		
Standard sensing object		Iron, 12 × 12 × 1 mm	Iron, 18 × 18 × 1 mm	Iron, 30 × 30 × 1 mm
Response frequency *2		1 kHz	0.5 kHz	0.25 kHz
Control output	Load current	3 to 100 mA		
	Residual voltage *3	5 V max. (Load current: 100 mA, Cable length: 2 m)		
Operation mode (with sensing object approaching)		Load ON: NO; For details, refer to the timing charts on page 5.		
Protection circuits		Load short-circuit protection, Surge suppressor		
Ambient temperature range		Operating: -25 to 70°C, Storage: -40 to 85°C, (with no icing or condensation)		
Temperature influence		±15% max. of sensing distance at 23°C in the temperature range of -40 to 85°C ±10% max. of sensing distance at 23°C in the temperature range of -25 to 70°C		±15% max. of sensing distance at 23°C in the temperature range of -25 to 70°C
Voltage influence		±1% max. of sensing distance at rated voltage in the rated voltage ±15% range		
Shock resistance		Destruction: 1,000m/s ² 10 times each in X, Y, and Z directions		
Connection method		Pre-wired Models (Standard cable length: 2 m), Pre-wired Connector Models		
Weight (packed state)	Pre-wired Models	Approx. 65 g	Approx. 140 g	Approx. 190 g
	Pre-wired Connector Models	Approx. 20 g	Approx. 40 g	Approx. 90 g

*1. Use the Sensor within the range in which the green indicator is ON.

*2. The response frequency is an average value.

*3. The residual voltage is 5 V. Make sure that the device connected to the Sensor can withstand the residual voltage.

Standard Models

Item		Model	E2EQ-X3D1 E2EQ-X3D1-M1(T)GJ	E2EQ-X7D1 E2EQ-X7D1-M1(T)GJ	E2EQ-X10D1 E2EQ-X10D1-M1(T)GJ
Sensing distance			3 mm ±10%	7 mm ±10%	10 mm ±10%
Set distance			0 to 2.4 mm	0 to 5.6 mm	0 to 8 mm
Differential travel			10% max. of sensing distance		
Standard sensing object			Iron, 12 × 12 × 1 mm	Iron, 18 × 18 × 1 mm	Iron, 30 × 30 × 1 mm
Response frequency *			1 kHz	500 Hz	400 Hz
Control output	Load current		3 to 100 mA		
	Residual voltage		3 V max. (Load current: 100 mA, Cable length: 2 m)		
Operation mode (with sensing object approaching)			Load ON: NO; For details, refer to the timing charts on page 5.		
Protection circuits			Load short-circuit protection, Surge suppressor		
Ambient temperature range			Operating/Storage: -25 to 70°C (with no icing or condensation)		
Temperature influence			±10% max. of sensing distance at 23°C in the temperature range of -25 to 70°C		
Voltage influence			±2.5% max. of sensing distance at rated voltage in the rated voltage ±15% range		
Shock resistance			Destruction: 1,000 m/s ² 10 times each in X, Y, and Z directions		
Connection method			E2EQ-X□D1: Pre-wired Models (Standard cable length: 2 m) E2EQ-X□D1-M1GJ: Pre-wired Connector Models (Standard cable length: 300mm)		
Weight (packed state)	Pre-wired Models		Approx. 120 g	Approx. 160 g	Approx. 220 g
	Pre-wired Connector Models		Approx. 80 g	Approx. 110 g	Approx. 190 g

* The response frequency is an average value. Measurement conditions are as follows: standard sensing object, a distance of twice the standard sensing object, and a set distance of half the sensing distance.

Common Ratings and Performance

Item		Model	E2EQ-X4X1 E2EQ-X4X1-M1(T)J E2EQ-X3D1 E2EQ-X3D1-M1(T)GJ	E2EQ-X8X1 E2EQ-X8X1-M1(T)J E2EQ-X7D1 E2EQ-X7D1-M1(T)GJ	E2EQ-X15X1 E2EQ-X15X1-M1(T)J E2EQ-X10D1 E2EQ-X10D1-M1(T)GJ
Detectable object			Ferrous metal (The sensing distance decreases with non-ferrous metal. Refer to <i>Engineering Data</i> on page 4.)		
Power supply voltage (operating voltage range)			12 to 24 VDC (10 to 30 VDC), ripple (p-p): 10% max.		
Leakage current			0.8 mA max.		
Indicators			Operation indicator (red), Setting indicator (green)		
Ambient humidity range			Operating/Storage: 35% to 95% (with no condensation)		
Insulation resistance			50 MΩ min. (at 500 VDC) between current-carrying parts and case		
Dielectric strength			1,000 VAC for 1 min between current-carrying parts and case		
Vibration resistance			Destruction: 10 to 55 Hz, 1.5-mm double amplitude for 2 hours each in X, Y, and Z directions		
Degree of protection			IEC 60529 IP67, in-house standards: oil-resistant		
Materials	Case		Fluororesin coating (Base material: brass)		
	Sensing surface		Fluororesin		
	Clamping nuts		Fluororesin coating (Base material: brass)		
	Toothed washer		Zinc-plated iron		
Accessories			Instruction manual		

Engineering Data (Reference Value)

Sensing Area

E2EQ-X□X□(-M1(T)J) Shielded Models E2EQ-X□D□(-M1(T)GJ)

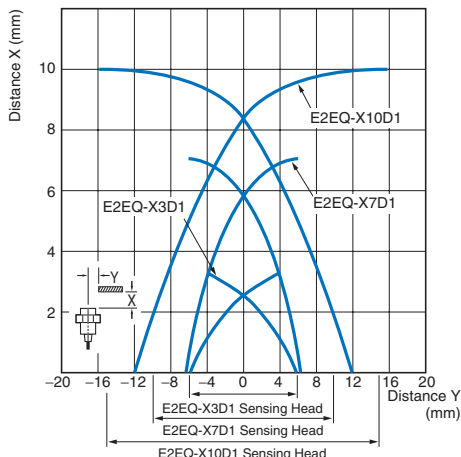
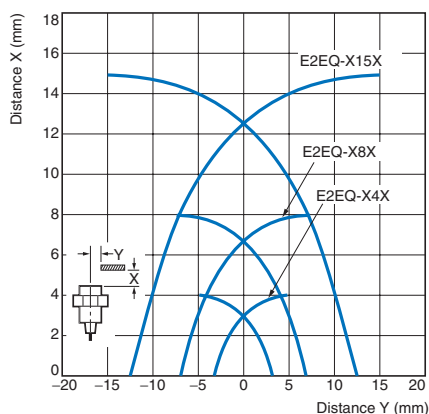

Influence of Sensing Object Size and Material

E2EQ-X4X1(-M1(T)J)

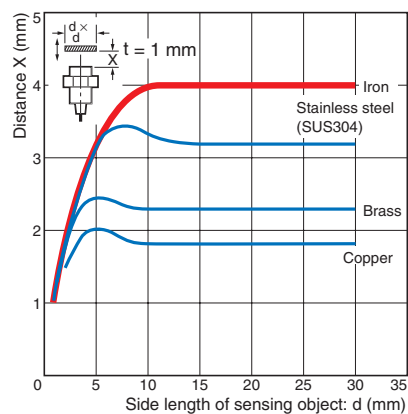

E2EQ-X8X1(-M1(T)J)

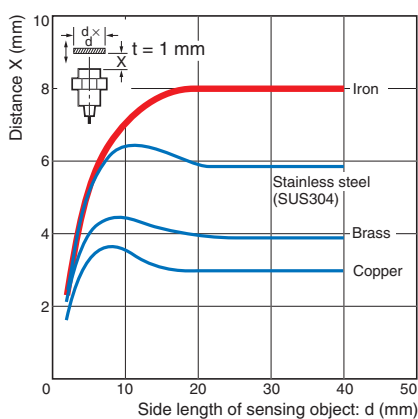

E2EQ-X15X1(-M1(T)J)

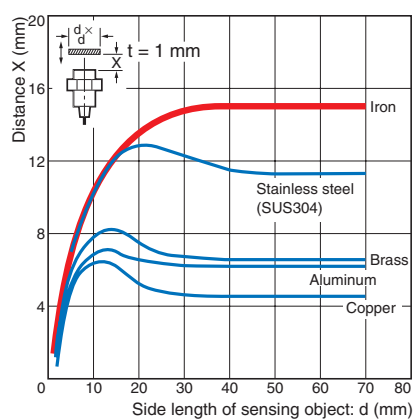

E2EQ-X3D1(-M1(T)GJ)

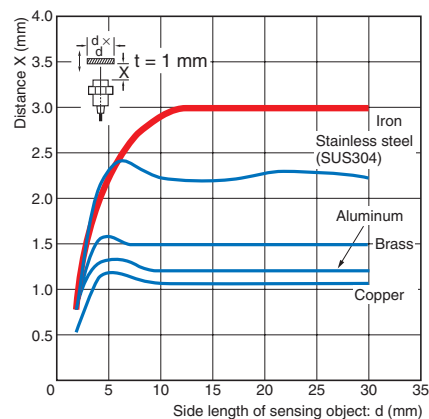

E2EQ-X7D1(-M1(T)GJ)

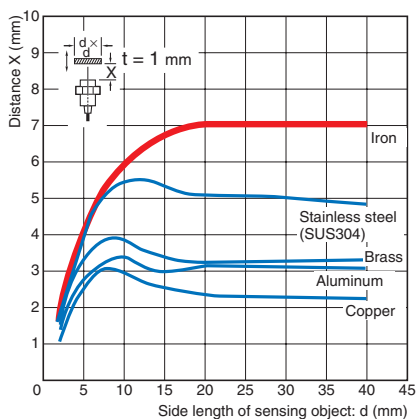

E2EQ-X10D1(-M1(T)GJ)

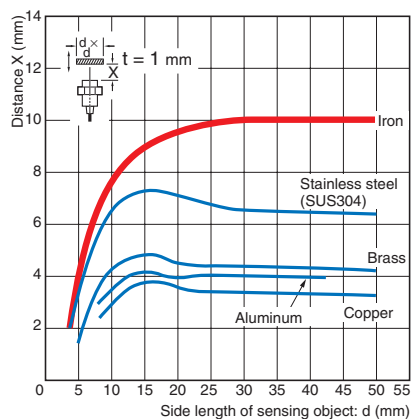

Residual Output Voltage

E2EQ-X□□□(-M1(T)J)

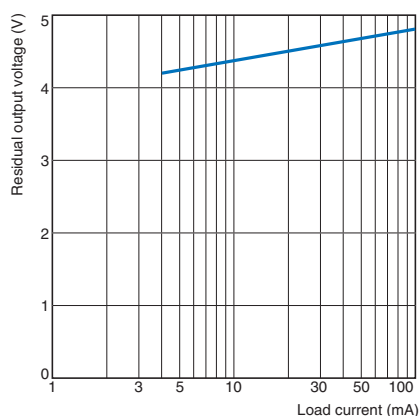

E2EQ-X□□D□(-M1(T)GJ)

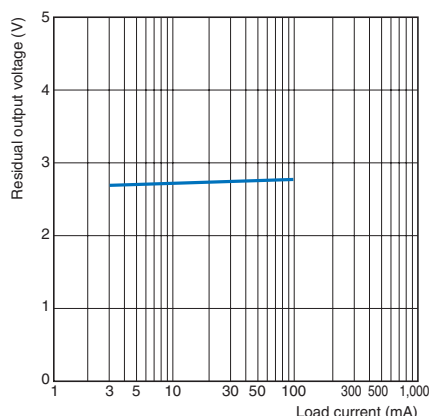

Leakage Current

E2EQ-X□□D

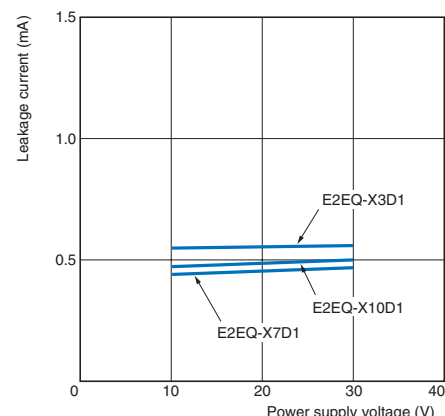

I/O Circuit Diagrams

Long Sensing-distance Models

Model	Operation mode	Timing Chart	Output circuit
E2EQ-X4X1 E2EQ-X8X1 E2EQ-X15X1 E2EQ-X4X1-M1(T)J E2EQ-X8X1-M1(T)J E2EQ-X15X1-M1(T)J	NO	<p>Setting indicator (green) ON/OFF Operation indicator (red) ON/OFF Control output ON/OFF</p>	<p>Note 1. The load can be connected to either the +V or 0 V side. Note 2. There is no polarity. Therefore, the brown and blue lines have no polarity.</p> <p>Connector Pin Arrangement</p> <p>Note: Pins 1 and 2 are not used.</p>

Standard Models

Model	Operation mode	Timing Chart	Output circuit
E2EQ-X3D1 E2EQ-X7D1 E2EQ-X10D1 E2EQ-X3D1-M1(T)GJ E2EQ-X7D1-M1(T)GJ E2EQ-X10D1-M1(T)GJ	NO	<p>Setting indicator (green) ON/OFF Operation indicator (red) ON/OFF Control output ON/OFF</p>	<p>Note: The load can be connected to either the +V or 0 V side.</p> <p>Connector Pin Arrangement</p> <p>Note: Pins 2 and 3 are not used.</p>

Pre-wired Connector Model Connections

Model	E2EQ-X□X1-M1(T)J		E2EQ-X□D1-M1(T)GJ	
Connections	Pre-wired Connector Model E2EQ-X□X1-M1J	Sensor I/O Connector XS2F-D42□-□C0-F	Pre-wired Connector Model E2EQ-X□D1-M1GJ	Sensor I/O Connector XS2F-D42□-□A0-F
		 ○ Brown (not used) ○ Blue (-) ○ Black (+)		 ○ Brown (+) ○ Blue (-)
	Pre-wired Connector Model E2EQ-X□X1-M1TJ	Sensor I/O Connector XS5F-D421-□80-F	Pre-wired Connector Model E2EQ-X□D1-M1TGJ	Sensor I/O Connector XS5F-D421-□80-F
		 ○ Brown (not used) ○ White (not used) ○ Blue (-) ○ Black (+)		 ○ Brown (+) ○ White (not used) ○ Blue (not used) ○ Black (-)

Safety Precautions

Refer to *Warranty and Limitations of Liability*.

⚠ WARNING

This product is not designed or rated for ensuring safety of persons either directly or indirectly. Do not use it for such purposes.



Precautions for Correct Use

Do not use this product under ambient conditions that exceed the ratings.

● Design

Influence of Surrounding Metal

When mounting the Sensor within a metal panel, ensure that the clearances given in the following table are maintained. Failure to maintain these distances may cause deterioration in the performance of the Sensor.

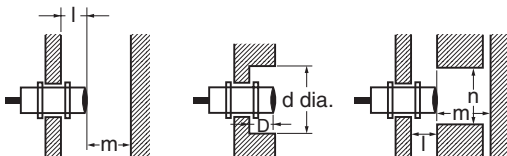

Influence of Surrounding Metal (Unit: mm)

Model	Item	l	d	D	m	n
E2EQ-X4X1(-M1(T)J)		2.4	18	2.4	12	18
E2EQ-X8X1(-M1(T)J)		3.6	27	3.6	24	27
E2EQ-X15X1(-M1(T)J)		6	45	6	45	45
E2EQ-X3D1(-M1(T)GJ)		12			8	18
E2EQ-X7D1(-M1(T)GJ)	0	18	0		20	27
E2EQ-X10D1(-M1(T)GJ)		30			40	45

Mutual Interference

When installing two or more Sensors face-to-face or side-by-side, ensure that the minimum distances given in the following table are maintained.

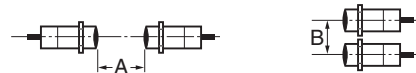

Mutual Interference (Unit: mm)

Model	Item	A	B
E2EQ-X4X1(-M1(T)J)		30	20
E2EQ-X8X1(-M1(T)J)		60	35
E2EQ-X15X1(-M1(T)J)		110	90
E2EQ-X3D1(-M1(T)GJ)		30	20
E2EQ-X7D1(-M1(T)GJ)		50	35
E2EQ-X10D1(-M1(T)GJ)		100	70

● Mounting

Do not tighten the nut with excessive force. A washer must be used with the nut.

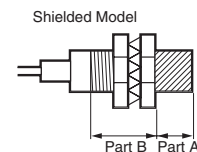

Note: 1. The allowable tightening strength depends on the distance from the edge of the head, as shown in the following table. (A is the distance from the edge of the head. B includes the nut on the head side. If the edge of the nut is in part A, the tightening torque for part A applies instead.)

2. The following torque assume washers are being used.

Model	Torque	Part A		Part B
		Dimension (mm)	Torque	Torque
E2EQ-X4X1(-M1(T)J)	---	---	30 N·m	
E2EQ-X8X1(-M1(T)J)			70 N·m	
E2EQ-X15X1(-M1(T)J)			180 N·m	
E2EQ-X3D1(-M1(T)GJ)	24	15 N·m	---	
E2EQ-X7D1(-M1(T)GJ)	29		---	
E2EQ-X10D1(-M1(T)GJ)	26	39 N·m	78 N·m	

Dimensions

Tolerance class IT16 applies to dimensions in this data sheet unless otherwise specified.

Pre-wired Models

Long Sensing-distance Models

E2EQ-X4X1

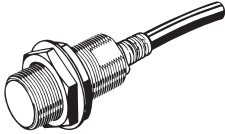
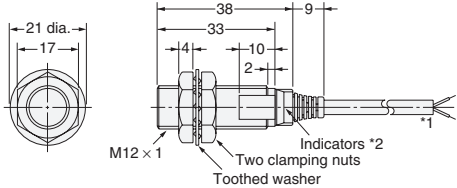
*1. 4-dia. vinyl-insulated round cable with 2 conductors (Flame-resistant, Conductor cross section: 0.3 mm², Insulator diameter: 1.3 mm), Standard length: 2 m
The cable can be extended up to 200 m (separate metal conduit).
*2. Operation indicator (red), Setting indicator (green)

E2EQ-X8X1

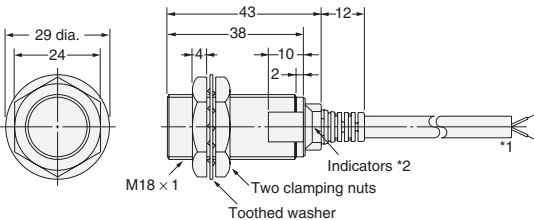

*1. 6-dia. vinyl-insulated round cable with 2 conductors (Flame-resistant, Conductor cross section: 0.5 mm², Insulator diameter: 1.9 mm), Standard length: 2 m
The cable can be extended up to 200 m (separate metal conduit).
*2. Operation indicator (red), Setting indicator (green)

E2EQ-X15X1

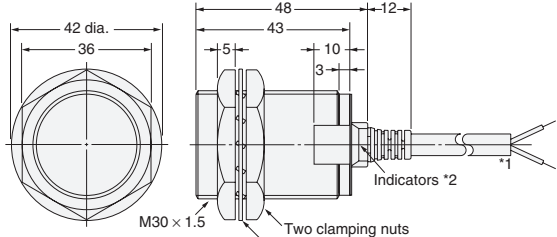

*1. 6-dia. vinyl-insulated round cable with 2 conductors (Flame-resistant, Conductor cross section: 0.5 mm², Insulator diameter: 1.9 mm), Standard length: 2 m
The cable can be extended up to 200 m (separate metal conduit).
*2. Operation indicator (red), Setting indicator (green)

Standard Models

E2EQ-X3D1

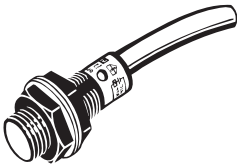
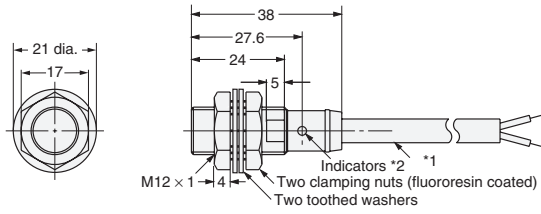
*1. 6-dia. vinyl-insulated round cable with 2 conductors (Flame-resistant, Conductor cross section: 0.5 mm², Insulator diameter: 1.9 mm), Standard length: 2 m
The cable can be extended up to 200 m (separate metal conduit).
*2. Operation indicator (red), Setting indicator (green)

E2EQ-X7D1

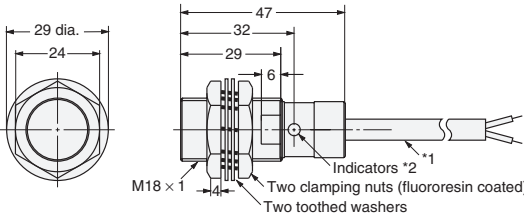

*1. 6-dia. vinyl-insulated round cable with 2 conductors (Flame-resistant, Conductor cross section: 0.5 mm², Insulator diameter: 1.9 mm), Standard length: 2 m
The cable can be extended up to 200 m (separate metal conduit).
*2. Operation indicator (red), Setting indicator (green)

E2EQ-X10D1

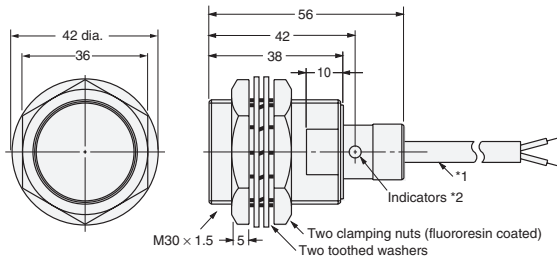

*1. 6-dia. vinyl-insulated round cable with 2 conductors (Flame-resistant, Conductor cross section: 0.5 mm², Insulator diameter: 1.9 mm), Standard length: 2 m
The cable can be extended up to 200 m (separate metal conduit).
*2. Operation indicator (red), Setting indicator (green)

Pre-wired Connector Models

Long Sensing-distance Models

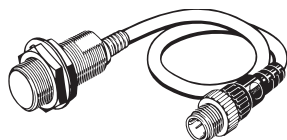

E2EQ-X4X1-M1(T)J

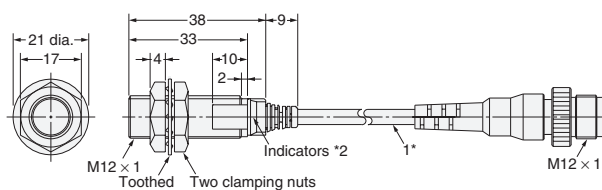

*1. 4-dia. vinyl-insulated round cable (Flame-resistant, Conductor cross section: 0.3 mm², Insulator diameter: 1.3 mm), Standard length: 300 mm
 *2. Operation indicator (red), Setting indicator (green)

E2EQ-X8X1-M1(T)J

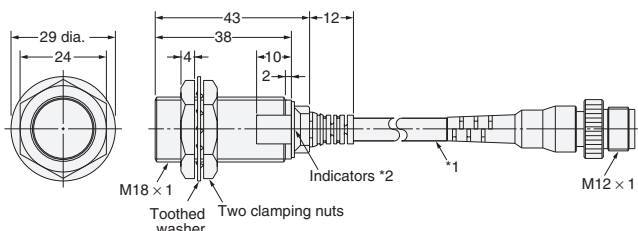

*1. 6-dia. vinyl-insulated round cable (Flame-resistant, Conductor cross section: 0.5 mm², Insulator diameter: 1.9 mm), Standard length: 300 mm
 *2. Operation indicator (red), Setting indicator (green)

E2EQ-X15X1-M1(T)J

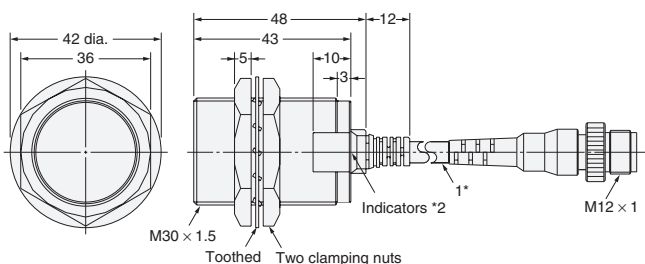

*1. 6-dia. vinyl-insulated round cable (Flame-resistant, Conductor cross section: 0.5 mm², Insulator diameter: 1.9 mm), Standard length: 300 mm
 *2. Operation indicator (red), Setting indicator (green)

Standard Models

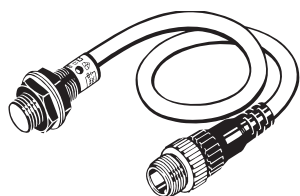

E2EQ-X3D1-M1(T)GJ

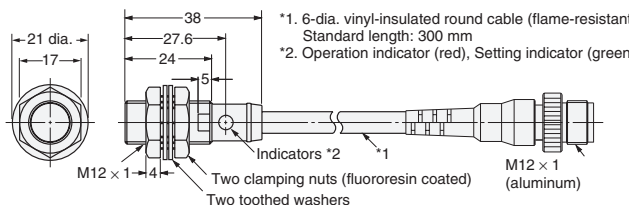

*1. 6-dia. vinyl-insulated round cable (flame-resistant), Standard length: 300 mm
 *2. Operation indicator (red), Setting indicator (green)

E2EQ-X7D1-M1(T)GJ

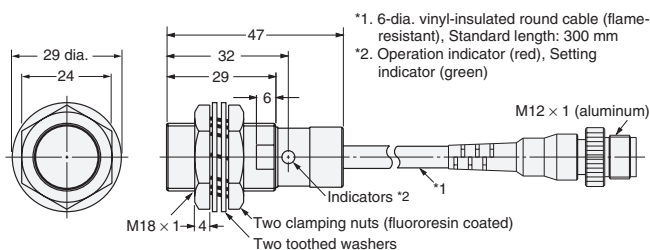

*1. 6-dia. vinyl-insulated round cable (flame-resistant), Standard length: 300 mm
 *2. Operation indicator (red), Setting indicator (green)

E2EQ-X10D1-M1(T)GJ

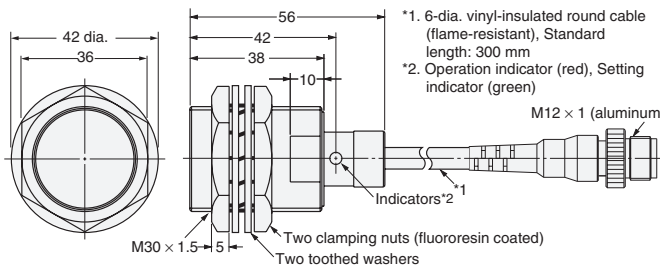

*1. 6-dia. vinyl-insulated round cable (flame-resistant), Standard length: 300 mm
 *2. Operation indicator (red), Setting indicator (green)

Mounting Hole Dimensions



Model	E2EQ-X4X E2EQ-X3	E2EQ-X8X E2EQ-X7	E2EQ-X15X E2EQ-X10
F (mm)	12.5 ^{+0.5} ₀ dia.	18.5 ^{+0.5} ₀ dia.	30.5 ^{+0.5} ₀ dia.

Read and Understand This Catalog

Please read and understand this catalog before purchasing the products. Please consult your OMRON representative if you have any questions or comments.

Warranty and Limitations of Liability

WARRANTY

OMRON's exclusive warranty is that the products are free from defects in materials and workmanship for a period of one year (or other period if specified) from date of sale by OMRON.

OMRON MAKES NO WARRANTY OR REPRESENTATION, EXPRESS OR IMPLIED, REGARDING NON-INFRINGEMENT, MERCHANTABILITY, OR FITNESS FOR PARTICULAR PURPOSE OF THE PRODUCTS. ANY BUYER OR USER ACKNOWLEDGES THAT THE BUYER OR USER ALONE HAS DETERMINED THAT THE PRODUCTS WILL SUITABLY MEET THE REQUIREMENTS OF THEIR INTENDED USE. OMRON DISCLAIMS ALL OTHER WARRANTIES, EXPRESS OR IMPLIED.

LIMITATIONS OF LIABILITY

OMRON SHALL NOT BE RESPONSIBLE FOR SPECIAL, INDIRECT, OR CONSEQUENTIAL DAMAGES, LOSS OF PROFITS OR COMMERCIAL LOSS IN ANY WAY CONNECTED WITH THE PRODUCTS, WHETHER SUCH CLAIM IS BASED ON CONTRACT, WARRANTY, NEGLIGENCE, OR STRICT LIABILITY.

In no event shall the responsibility of OMRON for any act exceed the individual price of the product on which liability is asserted.

IN NO EVENT SHALL OMRON BE RESPONSIBLE FOR WARRANTY, REPAIR, OR OTHER CLAIMS REGARDING THE PRODUCTS UNLESS OMRON'S ANALYSIS CONFIRMS THAT THE PRODUCTS WERE PROPERLY HANDLED, STORED, INSTALLED, AND MAINTAINED AND NOT SUBJECT TO CONTAMINATION, ABUSE, MISUSE, OR INAPPROPRIATE MODIFICATION OR REPAIR.

Application Considerations

SUITABILITY FOR USE

OMRON shall not be responsible for conformity with any standards, codes, or regulations that apply to the combination of products in the customer's application or use of the products.

At the customer's request, OMRON will provide applicable third party certification documents identifying ratings and limitations of use that apply to the products. This information by itself is not sufficient for a complete determination of the suitability of the products in combination with the end product, machine, system, or other application or use.

The following are some examples of applications for which particular attention must be given. This is not intended to be an exhaustive list of all possible uses of the products, nor is it intended to imply that the uses listed may be suitable for the products:

- Outdoor use, uses involving potential chemical contamination or electrical interference, or conditions or uses not described in this catalog.
- Nuclear energy control systems, combustion systems, railroad systems, aviation systems, medical equipment, amusement machines, vehicles, safety equipment, and installations subject to separate industry or government regulations.
- Systems, machines, and equipment that could present a risk to life or property.

Please know and observe all prohibitions of use applicable to the products.

NEVER USE THE PRODUCTS FOR AN APPLICATION INVOLVING SERIOUS RISK TO LIFE OR PROPERTY WITHOUT ENSURING THAT THE SYSTEM AS A WHOLE HAS BEEN DESIGNED TO ADDRESS THE RISKS, AND THAT THE OMRON PRODUCTS ARE PROPERLY RATED AND INSTALLED FOR THE INTENDED USE WITHIN THE OVERALL EQUIPMENT OR SYSTEM.

PROGRAMMABLE PRODUCTS

OMRON shall not be responsible for the user's programming of a programmable product, or any consequence thereof.

Disclaimers

CHANGE IN SPECIFICATIONS

Product specifications and accessories may be changed at any time based on improvements and other reasons.

It is our practice to change model numbers when published ratings or features are changed, or when significant construction changes are made. However, some specifications of the products may be changed without any notice. When in doubt, special model numbers may be assigned to fix or establish key specifications for your application on your request. Please consult with your OMRON representative at any time to confirm actual specifications of purchased products.

DIMENSIONS AND WEIGHTS

Dimensions and weights are nominal and are not to be used for manufacturing purposes, even when tolerances are shown.

PERFORMANCE DATA

Performance data given in this catalog is provided as a guide for the user in determining suitability and does not constitute a warranty. It may represent the result of OMRON's test conditions, and the users must correlate it to actual application requirements. Actual performance is subject to the OMRON Warranty and Limitations of Liability.

ERRORS AND OMISSIONS

The information in this document has been carefully checked and is believed to be accurate; however, no responsibility is assumed for clerical, typographical, or proofreading errors, or omissions.

2012.8

In the interest of product improvement, specifications are subject to change without notice.

OMRON Corporation
Industrial Automation Company

<http://www.ia.omron.com/>

(c)Copyright OMRON Corporation 2012 All Right Reserved.

Компания «Океан Электроники» предлагает заключение долгосрочных отношений при поставках импортных электронных компонентов на взаимовыгодных условиях!

Наши преимущества:

- Поставка оригинальных импортных электронных компонентов напрямую с производств Америки, Европы и Азии, а так же с крупнейших складов мира;
- Широкая линейка поставок активных и пассивных импортных электронных компонентов (более 30 млн. наименований);
- Поставка сложных, дефицитных, либо снятых с производства позиций;
- Оперативные сроки поставки под заказ (от 5 рабочих дней);
- Экспресс доставка в любую точку России;
- Помощь Конструкторского Отдела и консультации квалифицированных инженеров;
- Техническая поддержка проекта, помощь в подборе аналогов, поставка прототипов;
- Поставка электронных компонентов под контролем ВП;
- Система менеджмента качества сертифицирована по Международному стандарту ISO 9001;
- При необходимости вся продукция военного и аэрокосмического назначения проходит испытания и сертификацию в лаборатории (по согласованию с заказчиком);
- Поставка специализированных компонентов военного и аэрокосмического уровня качества (Xilinx, Altera, Analog Devices, Intersil, Interpoint, Microsemi, Actel, Aeroflex, Peregrine, VPT, Syfer, Eurofarad, Texas Instruments, MS Kennedy, Miteq, Cobham, E2V, MA-COM, Hittite, Mini-Circuits, General Dynamics и др.);

Компания «Океан Электроники» является официальным дистрибьютором и эксклюзивным представителем в России одного из крупнейших производителей разъемов военного и аэрокосмического назначения «JONHON», а так же официальным дистрибьютором и эксклюзивным представителем в России производителя высокотехнологичных и надежных решений для передачи СВЧ сигналов «FORSTAR».



JONHON

«JONHON» (основан в 1970 г.)

Разъемы специального, военного и аэрокосмического назначения:

(Применяются в военной, авиационной, аэрокосмической, морской, железнодорожной, горно- и нефтедобывающей отраслях промышленности)

«FORSTAR» (основан в 1998 г.)

ВЧ соединители, коаксиальные кабели, кабельные сборки и микроволновые компоненты:

(Применяются в телекоммуникациях гражданского и специального назначения, в средствах связи, РЛС, а так же военной, авиационной и аэрокосмической отраслях промышленности).



Телефон: 8 (812) 309-75-97 (многоканальный)

Факс: 8 (812) 320-03-32

Электронная почта: ocean@oceanchips.ru

Web: <http://oceanchips.ru/>

Адрес: 198099, г. Санкт-Петербург, ул. Калинина, д. 2, корп. 4, лит. А