

Description

Magnecraft General Purpose Relays

788 Series

DPDT and 3PDT 10 A



UL listed when used with proper Magnecraft sockets



788 Clear Cover



788 Full-Feature Cover

Description

The 788 Series square base, plug-in relays offer clear, full-feature, top flange, and side flange covers as well as optional sockets and accessories.

Feature	Benefit
10 A max. switching current	Ideal for automation panels and controls
Clear or full-feature cover options	Full-feature covers include LED indicator and locking test button
DPDT and 3PDT contact configurations	Simultaneously control separate circuits
Socket mount option	Simplifies installation and maintenance while also allowing the use of protection modules, hold-down clips and other accessories
Gold-flashed contacts	Reduces contact oxidation and increases shelf life
Mechanical flag indicator	Standard feature displays relay status during testing or operation

Contact Rating	Contact Configuration	Nominal Voltage	Coil Resistance (Ω)	Standard Part Number: Clear Cover	Standard Part Number: Clear Cover with LED	Standard Part Number: Flange Mount	Standard Part Number: Full-Feature
10 A	DPDT	12 Vac 50/60Hz	16.9	788XBXRC-12A	788XBXRCL-12A	788XBXRC1-12A	788XBXRM4L-12A
		24 Vac 50/60Hz	72	788XBXRC-24A	788XBXRCL-24A	788XBXRC1-24A	788XBXRM4L-24A
		120 Vac 50/60Hz	1700	788XBXRC-120A	788XBXRCL-120A	788XBXRC1-120A	788XBXRM4L-120A
		240 Vac 50/60Hz	6800	788XBXRC-240A	788XBXRCL-240A	788XBXRC1-240A	788XBXRM4L-240A
		12 Vdc	120	788XBXRC-12D	788XBXRCL-12D	788XBXRC1-12D	788XBXRM4L-12D
		24 Vdc	470	788XBXRC-24D	788XBXRCL-24D	788XBXRC1-24D	788XBXRM4L-24D
		48 Vdc	1800	788XBXRC-48D	788XBXRCL-48D	788XBXRC1-48D	788XBXRM4L-48D
	110 Vdc	7300	788XBXRC-110D	788XBXRCL-110D	788XBXRC1-110D	788XBXRM4L-110D	
	3PDT	12 Vac 50/60Hz	16.9	788XCXRC-12A	788XCXRCL-12A	788XCXRC1-12A	788XCXRM4L-12A
		24 Vac 50/60Hz	72	788XCXRC-24A	788XCXRCL-24A	788XCXRC1-24A	788XCXRM4L-24A
		120 Vac 50/60Hz	1700	788XCXRC-120A	788XCXRCL-120A	788XCXRC1-120A	788XCXRM4L-120A
		240 Vac 50/60Hz	6800	788XCXRC-240A	788XCXRCL-240A	788XCXRC1-240A	788XCXRM4L-240A
		12 Vdc	120	788XCXRC-12D	788XCXRCL-12D	788XCXRC1-12D	788XCXRM4L-12D
		24 Vdc	470	788XCXRC-24D	788XCXRCL-24D	788XCXRC1-24D	788XCXRM4L-24D
48 Vdc		1800	788XCXRC-48D	788XCXRCL-48D	788XCXRC1-48D	788XCXRM4L-48D	
110 Vdc	7300	788XCXRC-110D	788XCXRCL-110D	788XCXRC1-110D	788XCXRM4L-110D		

Note: Magnetic blowout versions are also available with an added contact rating of 3 A at 150 Vdc. Please refer to the Part Number Explanation shown below.

Part Number Explanation

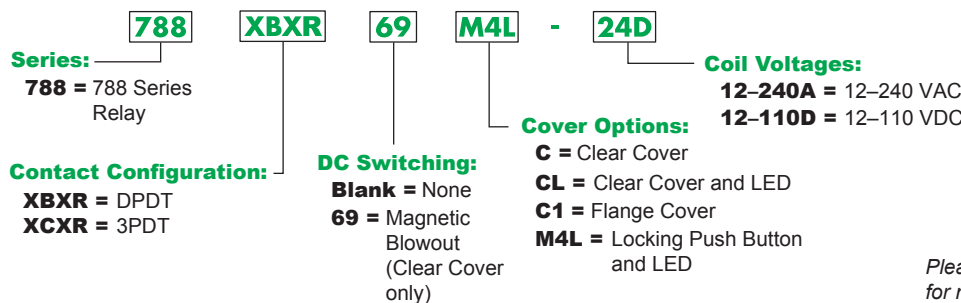

Please contact Customer Service for more information (847-441-2540).

Specifications

Part Number	788XBXR/XCXR
Contact Characteristics	
Terminal Style	Blade
Contact Configuration	DPDT/3PDT
Maximum Current	10 A
Contact Materials	Silver Alloy
Maximum Switching Voltage	IEC: 250 Vac / 28 Vdc UL/CSA: 300 Vac / 30 Vdc
Rated Switching Current at Voltage (Conforming to IEC AC-1 and DC-1)	NO: 10 A at 250 Vac, NC: 5 A at 250 Vac NO: 10 A at 28 Vdc, NC: 5 A at 28 Vdc
Rated Switching Current at Voltage (Conforming to UL)	Resistive: 10 A at 277 Vac 50 / 60 Hz, 200k cycles Resistive: 10 A at 30 Vdc, 200k cycles Motor: 1/3 HP at 120 Vac, 6k cycles Motor: 1 HP at 277 Vac, 6k cycles Pilot Duty: B300, 6k cycles
Rated Current with Magnetic Blowout (Code 69)	UL: 3 A at 150 Vdc (DPDT only), 6k cycles
Minimum Switching Requirement	10 mA at 17 Vdc
Coil Characteristics	
Maximum Operating Voltage	110% (AC / DC)
Maximum Pickup Voltage	85% (AC); 80% (DC)
Drop-out Voltage Threshold	15% (AC); 10% (DC)
Average Consumption	3 VA (AC); 1.4 W (DC)
General Characteristics	
Electrical Life at Rated Load	100,000 operations
Mechanical Life (Unpowered)	5,000,000 operations
Operating Time (Response Time)	20 ms
Dielectric Strength - Between Coil and Contact (AC)	2500 V(rms)
Dielectric Strength - Between Poles (AC)	2000 V(rms)
Dielectric Strength - Between Open Contacts (AC)	1500 V(rms)
Ambient Air Temperature around the Device - Storage	-40 to +85 °C (-40 to +185 °F)
Ambient Air Temperature around the Device - Operation	-40 to +55 °C (-40 to +131 °F)
Vibration Resistance - Operational	+/- 1 mm (10–35 Hz) and 3 g-n (35–150 Hz)
Shock Resistance	10 g-n
Degree of Protection (Housing Only)	IP 40
Weight	83 g (2.93 oz)
Agency Approvals	UL with socket, UR (E164862), CE, CSA (225619), RoHS

Note: Actual product performance may vary depending on application and environmental conditions.

Dimensions — inches (millimeters)

Clear Cover Dimensions



Full-Feature Cover Dimensions



Side Flange Cover Dimensions



Wiring Diagrams





Description

Optional sockets offer customizable, Fingersafe solutions including protection modules, hold-down clips, and ID tags. Sockets are DIN rail and panel mount compatible.

Relay Accessories



Description	Function	For Use With Relays	Pkg. Min.	Standard Part Number
Socket 1	DIN mount with elevator terminals	788XBXR/XCXR	10	70-788EL11-1
Socket 2	DIN/Panel mount with screw terminals and clamping plates		10	70-463-1
Socket 3	0.187 in. Quick Connect terminals with mounting tabs		10	70-124-2
Socket 4	Printed circuit terminals with mounting tabs		10	70-178-1
Socket 5	Printed circuit terminals without mounting tabs		10	70-178-2

Socket Accessories



Description	Function	For Use With Sockets	Coil Voltage	Pkg. Min.	Standard Part Number
Metal Spring Clip 1	Secures relay in socket	70-788EL11-1, 70-463-1, 70-124-1, 70-178-1, 70-178-2	–	10	16-1351
Metal Spring Clip 2	Secures relay in socket	70-463-1	–	10	16-1344
Insulated Coil Bus Jumper System 3	Wireless socket connection	70-788EL11-1	–	10	16-750/788CBJ-1
Plastic I.D. Tag 4	Write-on plastic labels	70-788EL11-1	–	10	16-750/788FT-1
Extruded Aluminum DIN Rail, 39.37" (1000 mm) 5	Quick installation and removal of sockets	70-788EL11-1, 70-463-1	–	10	16-700DIN
DIN Rail End Clip 6	Holds sockets firmly in place on DIN rail	–	–	10	16-DCLIP-1
Large Socket Module	MOV Suppressor (Protects from damaging electrical spikes)	70-788EL11-1	24 Vac/Vdc	10	70-ASMM-24
Large Socket Module	Protection Diode (Protects external drive circuitry from inductive voltages)		250 Vdc	10	70-ASMD-250
Large Socket Module 8	LED Indicator (Provides coil status at a glance)		110/240 Vac/Vdc	10	70-ASMLG-110/240
Large Socket Module	RC Suppressor (Snubs back EMF of relay coil)		110/240 Vac	10	70-ASMR-110/240

Note: Use of LED or RC socket module may increase coil power draw by up to 10%.

Компания «Океан Электроники» предлагает заключение долгосрочных отношений при поставках импортных электронных компонентов на взаимовыгодных условиях!

Наши преимущества:

- Поставка оригинальных импортных электронных компонентов напрямую с производств Америки, Европы и Азии, а так же с крупнейших складов мира;
- Широкая линейка поставок активных и пассивных импортных электронных компонентов (более 30 млн. наименований);
- Поставка сложных, дефицитных, либо снятых с производства позиций;
- Оперативные сроки поставки под заказ (от 5 рабочих дней);
- Экспресс доставка в любую точку России;
- Помощь Конструкторского Отдела и консультации квалифицированных инженеров;
- Техническая поддержка проекта, помощь в подборе аналогов, поставка прототипов;
- Поставка электронных компонентов под контролем ВП;
- Система менеджмента качества сертифицирована по Международному стандарту ISO 9001;
- При необходимости вся продукция военного и аэрокосмического назначения проходит испытания и сертификацию в лаборатории (по согласованию с заказчиком);
- Поставка специализированных компонентов военного и аэрокосмического уровня качества (Xilinx, Altera, Analog Devices, Intersil, Interpoint, Microsemi, Actel, Aeroflex, Peregrine, VPT, Syfer, Eurofarad, Texas Instruments, MS Kennedy, Miteq, Cobham, E2V, MA-COM, Hittite, Mini-Circuits, General Dynamics и др.);

Компания «Океан Электроники» является официальным дистрибьютором и эксклюзивным представителем в России одного из крупнейших производителей разъемов военного и аэрокосмического назначения «JONHON», а так же официальным дистрибьютором и эксклюзивным представителем в России производителя высокотехнологичных и надежных решений для передачи СВЧ сигналов «FORSTAR».



JONHON

«JONHON» (основан в 1970 г.)

Разъемы специального, военного и аэрокосмического назначения:

(Применяются в военной, авиационной, аэрокосмической, морской, железнодорожной, горно- и нефтедобывающей отраслях промышленности)

«FORSTAR» (основан в 1998 г.)

ВЧ соединители, коаксиальные кабели, кабельные сборки и микроволновые компоненты:

(Применяются в телекоммуникациях гражданского и специального назначения, в средствах связи, РЛС, а так же военной, авиационной и аэрокосмической отраслях промышленности).



Телефон: 8 (812) 309-75-97 (многоканальный)

Факс: 8 (812) 320-03-32

Электронная почта: ocean@oceanchips.ru

Web: <http://oceanchips.ru/>

Адрес: 198099, г. Санкт-Петербург, ул. Калинина, д. 2, корп. 4, лит. А