

MAX9918/MAX9919/MAX9920

-20V to +75V Input Range, Precision Uni-/Bidirectional, Current-Sense Amplifiers

General Description

The MAX9918/MAX9919/MAX9920 are single-supply, high-accuracy current-sense amplifiers with a high input common-mode range that extends from -20V to +75V. These amplifiers are well suited for current monitoring of inductive loads such as motors and solenoids, where common-mode voltages can become negative due to inductive kickback, reverse-battery conditions, or transient events.

The MAX9918/MAX9920 feature adjustable gain set by an external resistive-divider network. The MAX9919 features fixed gains of 45V/V (MAX9919F) and 90V/V (MAX9919N). The MAX9918/MAX9919/MAX9920 operate as unidirectional amplifiers when $V_{REFIN} = GND$ and as bidirectional amplifiers when $V_{REFIN} = V_{CC}/2$. The MAX9920 attenuates the input signal by a factor of 4 at the input level-shifting stage allowing the device to sense voltages up to 200mV (unidirectional operation) or ± 100 mV (bidirectional operation).

The MAX9918/MAX9919/MAX9920 operate with a single 5V supply voltage, are fully specified over the $-40^{\circ}C$ to $+125^{\circ}C$ automotive temperature range, and are available in an 8-pin SOIC package.

Applications

- H-Bridge Motor Current Sensing
- Solenoid Current Sensing
- Current Monitoring of Inductive Loads
- High- and Low-Side Precision Current Sensing
- Super-Capacitor Charge/Discharge Monitoring
- Precision High-Voltage Current Monitoring
- Automotive

Typical Operating Circuit

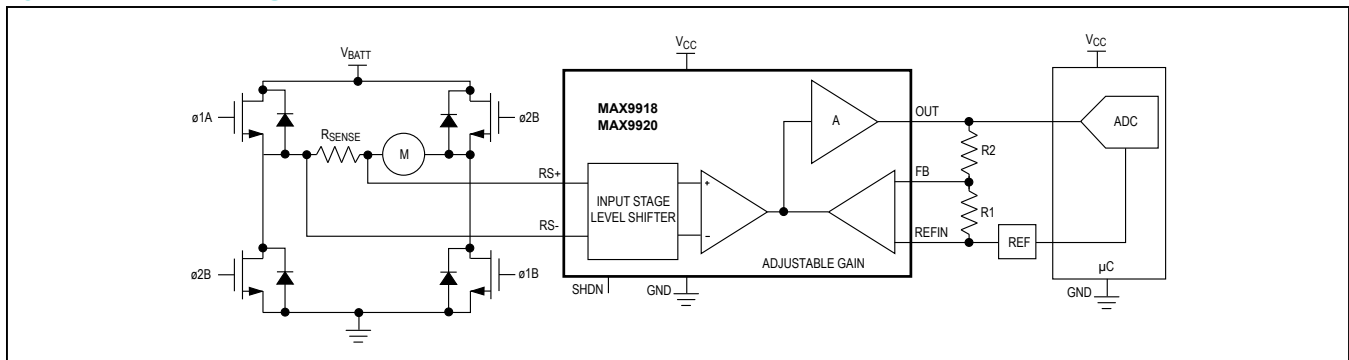

Benefits and Features

- Reduce Protective Clamping for High Inductive Kickback Voltage
 - -20V to +75V Input Common-Mode Voltage Range
- Supports Wide Range of Precision AC and DC Current Sensing Applications
 - Uni- or Bidirectional Current Sensing
 - 0.6% (max) Gain Accuracy Error
 - 400 μ V (max) Input Offset Voltage
 - 120kHz, -3dB Bandwidth (MAX9919N)
 - Reference Input for Bidirectional OUT
 - Rail-to-Rail Output
- Saves Board Space
 - 8-Pin SOIC Package
 - Single-Supply Operation (4.5V to 5.5V)
- AEC-Q100 Qualified (MAX9918ASA/V+, MAX9919FASA/V+, MAX9919NASA/V+, MAX9920ASA/V+ Only)

Ordering Information/Selector Guide

PART	VSENSE (mV)	GAIN (V/V)	PIN-PACKAGE
MAX9918ASA+	± 50	Adjustable	8 SO-EP*
MAX9918ASA/V+	± 50	Adjustable	8 SO-EP*
MAX9919FASA+	± 50	45	8 SO-EP*
MAX9919FASA/V+	± 50	45	8 SO-EP*
MAX9919NASA+	± 50	90	8 SO-EP*
MAX9919NASA/V+	± 50	90	8 SO-EP*
MAX9920ASA+	± 200	Adjustable	8 SO-EP*
MAX9920ASA/V+	± 200	Adjustable	8 SO-EP*

Note: All devices operate over the $-40^{\circ}C$ to $+125^{\circ}C$ temperature range.

+Denotes a lead(Pb)-free/RoHS-compliant package.

/V denotes an automotive qualified part.

*EP = Exposed pad.

MAX9918/MAX9919/MAX9920

-20V to +75V Input Range,
Precision Uni-/Bidirectional,
Current-Sense Amplifiers

Absolute Maximum Ratings

V_{CC} to GND-0.3V to +6V
 RS+, RS- to GND (V_{CC} = 5V).....-30V to +80V
 RS+, RS- to GND (V_{CC} = 0V).....-15V to +80V (15 minutes)
 Differential Input Voltage (V_{RS+} - V_{RS-})
 (MAX9918/MAX9919).....±15V (Continuous)
 Differential Input Voltage
 (V_{RS+} - V_{RS-}) (MAX9920).....±5V (Continuous)
 REFIN, FB, OUT to GND-0.3V to (V_{CC} + 0.3V)
 SHDN to GND-0.3V to +20V
 **As per JEDEC51 Standard (multilayer board).

Output Short Circuit to V_{CC} or GNDContinuous
 Continuous Current into Any Pin
 (Not to exceed package power dissipation)±20mA
 Continuous Power Dissipation (T_A = +70°C)
 8-Pin SO-EP (derate 24.4mW/°C above +70°C) .. 1951.2mW**
 Junction Temperature..... +150°C
 Storage Temperature Range -65°C to +150°C
 Lead Temperature (soldering, 10s)+300°C
 Soldering Temperature (reflow).....+260°C

Package Thermal Characteristics (Note 1)

SO-EP
 Junction-to-Ambient Thermal Resistance (θ_{JA})41°C/W
 Junction-to-Case Thermal Resistance (θ_{JC}).....7°C/W

Note 1: Package thermal resistances were obtained using the method described in JEDEC specification JESD51-7, using a four-layer board. For detailed information on package thermal considerations, refer to www.maximintegrated.com/thermal-tutorial.

Stresses beyond those listed under "Absolute Maximum Ratings" may cause permanent damage to the device. These are stress ratings only, and functional operation of the device at these or any other conditions beyond those indicated in the operational sections of the specifications is not implied. Exposure to absolute maximum rating conditions for extended periods may affect device reliability.

Package Information

8 SO-EP

PACKAGE CODE	S8E+14
Outline Number	21-0111
Land Pattern Number	90-0151
Thermal Resistance, Single-Layer Board:	
Junction to Ambient (θ _{JA})	52°C/W
Junction to Case (θ _{JC})	6°C/W
Thermal Resistance, Four-Layer Board:	
Junction to Ambient (θ _{JA})	41°C/W
Junction to Case (θ _{JC})	7°C/W

For the latest package outline information and land patterns (footprints), go to www.maximintegrated.com/packages. Note that a "+", "#", or "-" in the package code indicates RoHS status only. Package drawings may show a different suffix character, but the drawing pertains to the package regardless of RoHS status.

Package thermal resistances were obtained using the method described in JEDEC specification JESD51-7, using a four-layer board. For detailed information on package thermal considerations, refer to www.maximintegrated.com/thermal-tutorial.

Electrical Characteristics

($V_{CC} = 5V$, $V_{RS+} = V_{RS-} = +14V$, $V_{SENSE} = (V_{RS+} - V_{RS-}) = 0V$, $V_{SHDN} = V_{GND} = 0V$, $V_{REFIN} = V_{CC}/2$, $R_L = 100k\Omega$; for MAX9918, $A_V = 90V/V$, $R2/R1 = 89k\Omega/1k\Omega$; for MAX9920, $A_V = 20V/V$, $R2/R1 = 79k\Omega/1k\Omega$; $T_A = -40^\circ C$ to $+125^\circ C$, unless otherwise noted. Typical values are at $T_A = +25^\circ C$.) (Note 1)

PARAMETER	SYMBOL	CONDITIONS		MIN	TYP	MAX	UNITS
Input Offset Voltage (Note 2)	V _{OS}	MAX9918	$V_{RS+} = V_{RS-} = +14V$, $V_{REFIN} = 0V$	$T_A = +25^\circ C$	± 0.14	± 0.4	mV
				$T_A = -40^\circ C$ to $+125^\circ C$		± 0.7	
			$V_{RS+} = V_{RS-} = -2V$, $V_{REFIN} = 0V$	$T_A = +25^\circ C$	± 0.08	± 0.4	
				$T_A = -40^\circ C$ to $+125^\circ C$		± 1.3	
		MAX9919_	$V_{RS+} = V_{RS-} = +14V$, $V_{REFIN} = 0V$	$T_A = +25^\circ C$	± 0.18	± 0.4	
				$T_A = -40^\circ C$ to $+125^\circ C$		± 0.9	
			$V_{RS+} = V_{RS-} = -2V$, $V_{REFIN} = 0V$	$T_A = +25^\circ C$	± 0.11	± 0.4	
				$T_A = -40^\circ C$ to $+125^\circ C$		± 1.0	
		MAX9920	$V_{RS+} = V_{RS-} = +14V$, $V_{REFIN} = 0V$	$T_A = +25^\circ C$	± 0.48	± 1.2	
				$T_A = -40^\circ C$ to $+125^\circ C$		± 3.0	
$V_{RS+} = V_{RS-} = -2V$, $V_{REFIN} = 0V$	$T_A = +25^\circ C$		± 0.10	± 0.9			
	$T_A = -40^\circ C$ to $+125^\circ C$			± 3.5			

MAX9918/MAX9919/MAX9920

-20V to +75V Input Range,
Precision Uni-/Bidirectional,
Current-Sense Amplifiers

Electrical Characteristics (continued)

($V_{CC} = 5V$, $V_{RS+} = V_{RS-} = +14V$, $V_{SENSE} = (V_{RS+} - V_{RS-}) = 0V$, $V_{SHDN} = V_{GND} = 0V$, $V_{REFIN} = V_{CC}/2$, $R_L = 100k\Omega$; for MAX9918, $A_V = 90V/V$, $R2/R1 = 89k\Omega/1k\Omega$; for MAX9920, $A_V = 20V/V$, $R2/R1 = 79k\Omega/1k\Omega$; $T_A = -40^\circ C$ to $+125^\circ C$, unless otherwise noted. Typical values are at $T_A = +25^\circ C$.) (Note 1)

PARAMETERS	SYMBOL	CONDITIONS		MIN	TYP	MAX	UNITS
Input Offset Voltage Drift (Note 3)	V_{OSD}	MAX9918	$V_{RS+} = V_{RS-} = +14V$		± 1.2		$\mu V/^\circ C$
			$V_{RS+} = V_{RS-} = -2V$		± 3.3		
		MAX9919_	$V_{RS+} = V_{RS-} = +14V$		± 1.8		
			$V_{RS+} = V_{RS-} = -2V$		± 1.8		
		MAX9920	$V_{RS+} = V_{RS-} = +14V$		± 2.4		
			$V_{RS+} = V_{RS-} = -2V$		± 8.8		
Common-Mode Range	V_{CM}	Inferred from CMRR tests		-20		+75	V
Common-Mode Rejection Ratio (Note 3)	CMRR	MAX9918, MAX9919	$-2V \leq V_{CM} \leq +14V$	80			dB
			$-20V \leq V_{CM} \leq +75V$	96			
		MAX9920	$-2V \leq V_{CM} \leq +14V$	72			
			$-20V \leq V_{CM} \leq +75V$	86			
Input Bias Current	I_{RS+}, I_{RS-}	$-20V \leq V_{CM} \leq +75V$	$T_A = +25^\circ C$			± 175	μA
			$T_A = -40^\circ C$ to $+125^\circ C$			± 250	
Input Offset Current	$(I_{RS+} - I_{RS-})$				0	± 8	μA
Input Leakage Current in Shutdown			$-20V \leq V_{CM} \leq +75V$, $V_{SHDN} = V_{CC} = 5V$			± 30	μA
Input Leakage Current			$V_{RS+} = V_{RS-} = +14V$, $+75V$, $V_{CC} = 0V$			± 30	μA
Input Resistance		MAX9918, MAX9919_	Common mode		300		$k\Omega$
			Differential		715		Ω
		MAX9920	Common mode		330		$k\Omega$
			Differential		224		Ω
Full-Scale Sense Voltage (Note 4)	V_{SENSE}	Inferred from gain error test	MAX9918, MAX9919_		50		mV
			MAX9920		200		
Gain (Notes 2, 4)	G	MAX9918, MAX9920			Adj		V/V
		MAX9919F			45		
		MAX9919N			90		
Minimum Adjustable Gain	G_{ADJ}	MAX9918			30		V/V
		MAX9920			7.5		

MAX9918/MAX9919/MAX9920

-20V to +75V Input Range,
Precision Uni-/Bidirectional,
Current-Sense Amplifiers

Electrical Characteristics (continued)

($V_{CC} = 5V$, $V_{RS+} = V_{RS-} = +14V$, $V_{SENSE} = (V_{RS+} - V_{RS-}) = 0V$, $V_{SHDN} = V_{GND} = 0V$, $V_{REFIN} = V_{CC}/2$, $R_L = 100k\Omega$; for MAX9918, $A_V = 90V/V$, $R_2/R_1 = 89k\Omega/1k\Omega$; for MAX9920, $A_V = 20V/V$, $R_2/R_1 = 79k\Omega/1k\Omega$; $T_A = -40^\circ C$ to $+125^\circ C$, unless otherwise noted. Typical values are at $T_A = +25^\circ C$.) (Note 1)

PARAMETER	SYMBOL	CONDITIONS		MIN	TYP	MAX	UNITS	
Gain Error (Note 2)	GE	MAX9918	$V_{RS+} = V_{RS-} = +14V$	$T_A = +25^\circ C$, $V_{REFIN} = 0V$	± 0.08	± 0.6	%	
				$T_A = -40^\circ C$ to $+125^\circ C$, $V_{REFIN} = 0V$		± 1.2		
			$V_{RS+} = V_{RS-} = -2V$, $V_{REFIN} = 0V$	$T_A = +25^\circ C$	± 0.02	± 0.6		
				$T_A = -40^\circ C$ to $+125^\circ C$		± 1.0		
			MAX9919F	$V_{RS+} = V_{RS-} = +14V$, $V_{REFIN} = 0V$	$T_A = +25^\circ C$	± 0.13		± 0.45
					$T_A = -40^\circ C$ to $+125^\circ C$			± 1.2
		MAX9919N	$V_{RS+} = V_{RS-} = +14V$, $V_{REFIN} = 0V$	$T_A = +25^\circ C$	± 0.16	± 0.6		
				$T_A = -40^\circ C$ to $+125^\circ C$		± 1.2		
		MAX9919N	$V_{RS+} = V_{RS-} = -2V$, $V_{REFIN} = 0V$	$T_A = +25^\circ C$	± 0.11	± 0.6		
				$T_A = -40^\circ C$ to $+125^\circ C$		± 1.0		
		MAX9920	$V_{RS+} = V_{RS-} = +14V$, $V_{REFIN} = 0V$	$T_A = +25^\circ C$	± 0.29	± 1.0		
				$T_A = -40^\circ C$ to $+125^\circ C$		± 1.7		
MAX9920	$V_{RS+} = V_{RS-} = -2V$, $V_{REFIN} = 0V$	$T_A = +25^\circ C$	± 0.24	± 1.0				
		$T_A = -40^\circ C$ to $+125^\circ C$		± 1.7				
Output-Voltage High (Note 4)	$V_{CC} - V_{OH}$	$V_{SENSE} = 200mV$ for MAX9918, MAX9919_, $V_{SENSE} = 400mV$ for MAX9920	$R_L = 100k\Omega$ to GND	3	10	mV		
			$R_L = 10k\Omega$ to GND	12	40			
Output-Voltage Low (Note 4)	V_{OL}	$V_{SENSE} = -200mV$ for MAX9918, MAX9919_, $V_{SENSE} = -400mV$ for MAX9920	$R_L = 100k\Omega$ to V_{CC}	3	10	mV		
			$R_L = 10k\Omega$ to V_{CC}	10	40			
Short-Circuit Current	I_{SC}	OUT shorted to V_{CC}		44		mA		
		OUT shorted to GND		41				
Output Resistance	R_{OUT}			0.1		Ω		
REFIN Voltage Range		Inferred from REFIN CMRR test	MAX9918, MAX9919_	0	$V_{CC}/2$	$V_{CC} - 1.9$	V	
			MAX9920	0	$V_{CC}/2$	$V_{CC} - 2.4$		

MAX9918/MAX9919/MAX9920

-20V to +75V Input Range,
Precision Uni-/Bidirectional,
Current-Sense Amplifiers

Electrical Characteristics (continued)

($V_{CC} = 5V$, $V_{RS+} = V_{RS-} = +14V$, $V_{SENSE} = (V_{RS+} - V_{RS-}) = 0V$, $V_{SHDN} = V_{GND} = 0V$, $V_{REFIN} = V_{CC}/2$, $R_L = 100k\Omega$; for MAX9918, $A_V = 90V/V$, $R2/R1 = 89k\Omega/1k\Omega$; for MAX9920, $A_V = 20V/V$, $R2/R1 = 79k\Omega/1k\Omega$; $T_A = -40^\circ C$ to $+125^\circ C$, unless otherwise noted. Typical values are at $T_A = +25^\circ C$.) (Note 1)

PARAMETERS	SYMBOL	CONDITIONS		MIN	TYP	MAX	UNITS
REFIN Common-Mode Rejection Ratio	REFIN _{CMRR}	MAX9918, MAX9919_	$0V \leq V_{REFIN} \leq (V_{CC} - 1.9V)$	82	103		dB
		MAX9920	$0V \leq V_{REFIN} \leq (V_{CC} - 2.4V)$	75	90		
REFIN Current	I _{REFIN}	MAX9918, MAX9919_	$V_{RS+} = V_{RS-} = \pm 50mV$			±100	µA
		MAX9920	$V_{RS+} = V_{RS-} = \pm 200mV$			±100	
SHDN Logic-High	V _{IH}			2.0			V
SHDN Logic-Low	V _{IL}					0.8	V
SHDN Logic Input Current			$0 \leq V_{SHDN} \leq V_{CC}$			5	µA
Supply Voltage Range	V _{CC}		Inferred from PSRR test	4.5		5.5	V
Power-Supply Rejection Ratio (Note 3)	PSRR	MAX9918, MAX9919_	$4.5V \leq V_{CC} \leq 5.5V$	74	103		dB
		MAX9920	$4.5V \leq V_{CC} \leq 5.5V$	68	100		
Supply Current	I _{CC}	$V_{RS+} = V_{RS-} = +14V$	$T_A = +25^\circ C$		0.7	1.2	mA
			$T_A = -40^\circ C$ to $+125^\circ C$			1.5	
		$V_{RS+} = V_{RS-} = -2V$	$T_A = +25^\circ C$		1.0	1.6	
			$T_A = -40^\circ C$ to $+125^\circ C$			2.2	
Shutdown Supply Current	I _{CC_SHDN}		$V_{SHDN} = V_{CC} = 5V$		0.5	10	µA
Small Signal -3dB Bandwidth	BW		MAX9918, $V_{SENSE} = 50mV$		75		kHz
			MAX9919F, $V_{SENSE} = 50mV$		250		
			MAX9919N, $V_{SENSE} = 50mV$		120		
			MAX9920, $V_{SENSE} = 200mV$		230		
Slew Rate	SR		MAX9918		0.6		V/µs
			MAX9919F		0.9		
			MAX9919N		3.0		
			MAX9920		1.5		
1% Settling Time from V _{SENSE} Step		MAX9918	$V_{SENSE} = 5mV$ to 50mV step		12		µs
			$V_{SENSE} = 50mV$ to 5mV step		7		
		MAX9919F	$V_{SENSE} = 5mV$ to 50mV step		3.5		
			$V_{SENSE} = 50mV$ to 5mV step		2.5		
		MAX9919N	$V_{SENSE} = 5mV$ to 50mV step		3.5		
			$V_{SENSE} = 50mV$ to 5mV step		3		
		MAX9920	$V_{SENSE} = 20mV$ to 200mV step		5		
			$V_{SENSE} = 200mV$ to 20mV step		3		

Electrical Characteristics (continued)

($V_{CC} = 5V$, $V_{RS+} = V_{RS-} = +14V$, $V_{SENSE} = (V_{RS+} - V_{RS-}) = 0V$, $V_{SHDN} = V_{GND} = 0V$, $V_{REFIN} = V_{CC}/2$, $R_L = 100k\Omega$; for MAX9918, $A_V = 90V/V$, $R2/R1 = 89k\Omega/1k\Omega$; for MAX9920, $A_V = 20V/V$, $R2/R1 = 79k\Omega/1k\Omega$; $T_A = -40^\circ C$ to $+125^\circ C$, unless otherwise noted. Typical values are at $T_A = +25^\circ C$.) (Note 1)

PARAMETERS	SYMBOL	CONDITIONS		MIN	TYP	MAX	UNITS
1% Settling Time from VCM Step		MAX9918, $V_{SENSE} = 50mV$	$V_{CM} = -2V$ to $+14V$ step		2.5		μs
			$V_{CM} = +14V$ to $-2V$ step		0.5		
		MAX9919F, $V_{SENSE} = 50mV$	$V_{CM} = -2V$ to $+14V$ step		2.5		
			$V_{CM} = +14V$ to $-2V$ step		0.5		
		MAX9919N, $V_{SENSE} = 50mV$	$V_{CM} = -2V$ to $+14V$ step		3.5		
			$V_{CM} = +14V$ to $-2V$ step		3.5		
MAX9920, $V_{SENSE} = 200mV$	$V_{CM} = -2V$ to $+14V$ step		0.25				
	$V_{CM} = +14V$ to $-2V$ step		2.5				
Power-Up Time		MAX9918, $V_{SENSE} = 50mV$, 1% settling			4.5		μs
		MAX9919F, $V_{SENSE} = 50mV$, 1% settling			5		
		MAX9919N, $V_{SENSE} = 50mV$, 1% settling			6		
		MAX9920, $V_{SENSE} = 200mV$, 1% settling			5		
Max Capacitive Load Stability		No sustained oscillations (Note 5)		50			pF
Input-Referred Noise Voltage Density	e_n	10kHz	MAX9918, MAX9919_		60		nV/\sqrt{Hz}
			MAX9920		174		

- Note 1:** All devices are 100% production tested at $T_A = +25^\circ C$. All temperature limits are guaranteed by design.
- Note 2:** V_{OS} is extrapolated from two point gain error tests. Measurements are made at $V_{SENSE} = 5mV$ and $50mV$ for MAX9918/ MAX9919N/MAX9919F, and $V_{SENSE} = 20mV$ and $200mV$ for MAX9920.
- Note 3:** Extrapolated V_{OS} as described above in Note 2 is used to calculate V_{OS} drift, CMRR, and PSRR.
- Note 4:** OUT should be 100mV away from either rail to achieve rated accuracy, or limited by a V_{SENSE} of 50mV for the MAX9918/ MAX9919N/MAX9919F and 200mV for the MAX9920.
- Note 5:** Not production tested. Guaranteed by design.

Typical Operating Characteristics

($V_{CC} = 5V$, $T_A = +25^\circ C$, unless otherwise noted.)

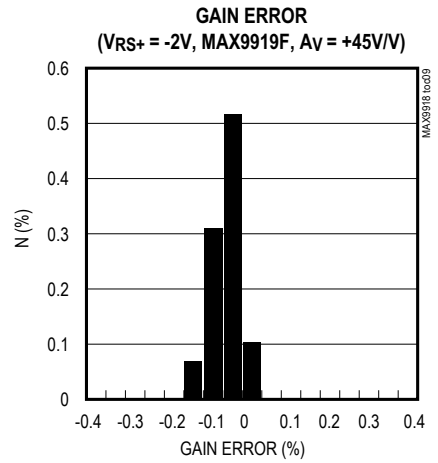
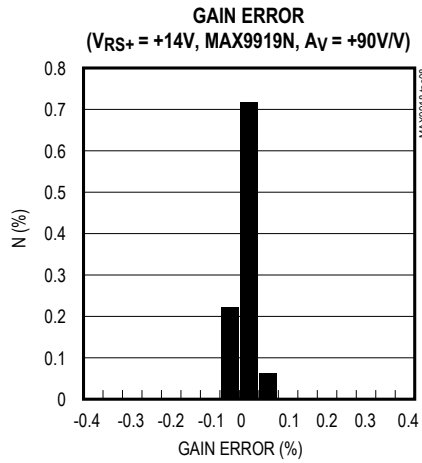
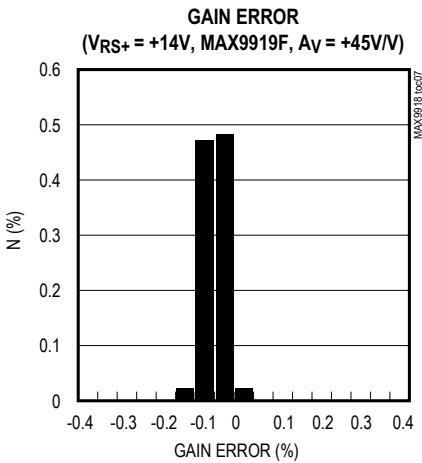
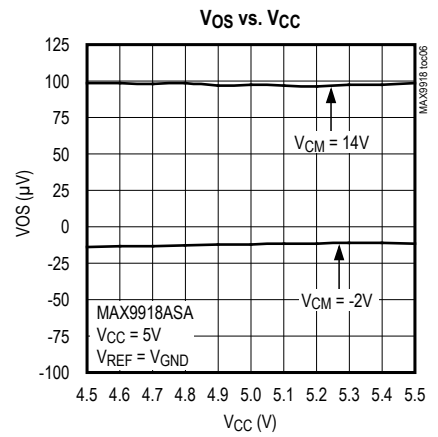
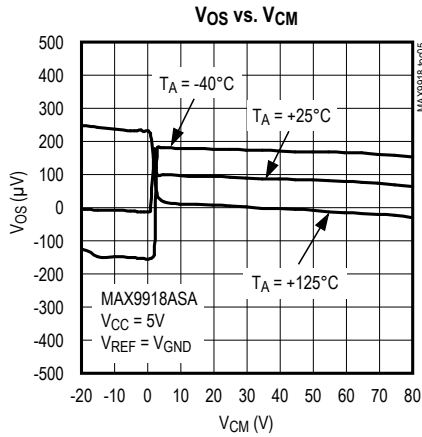
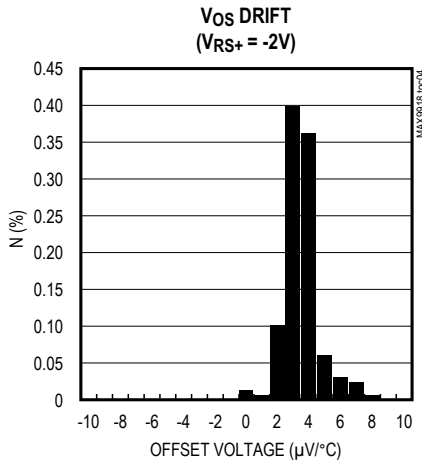
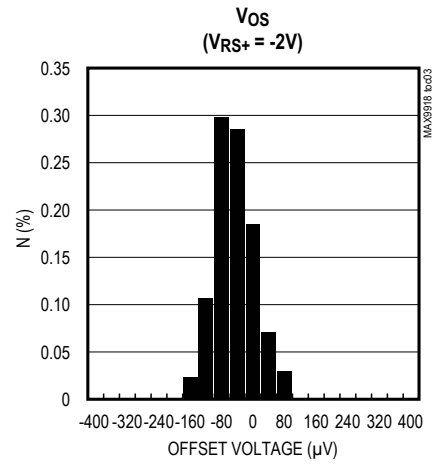
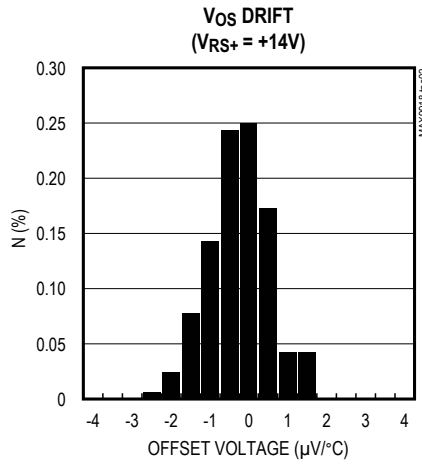
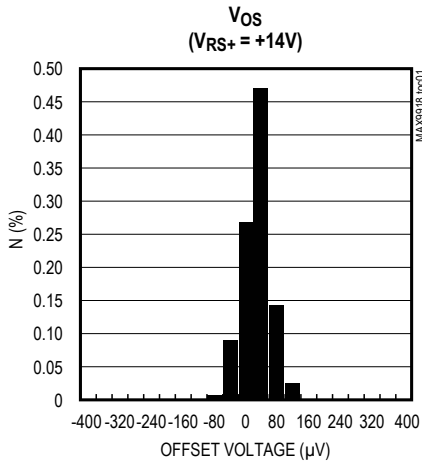

Typical Operating Characteristics (continued)

($V_{CC} = 5V$, $T_A = +25^\circ C$, unless otherwise noted.)

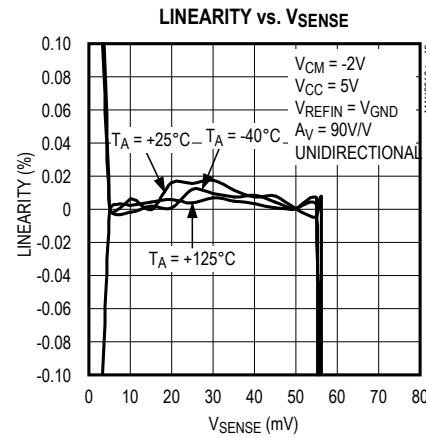
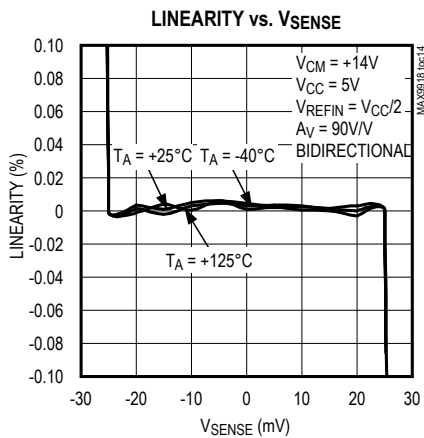
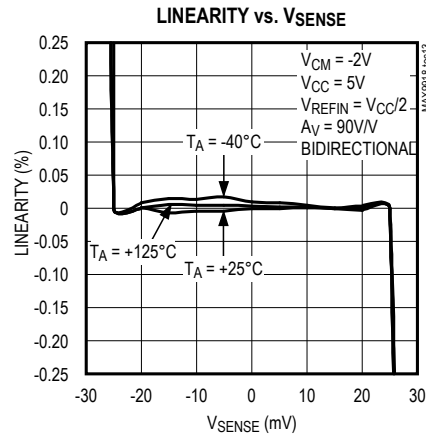
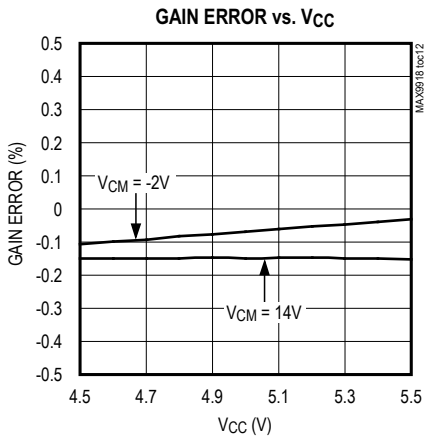
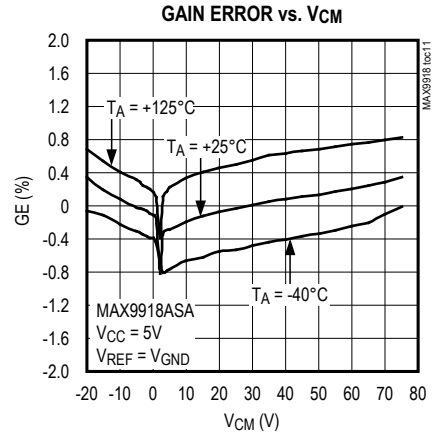
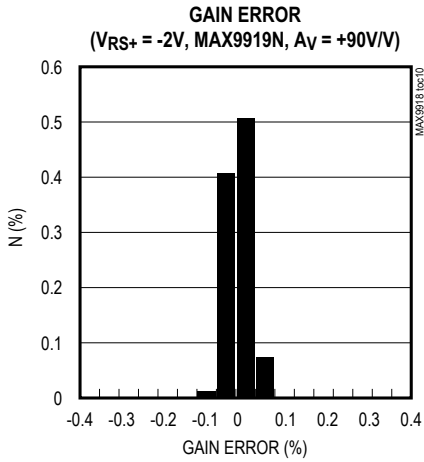

Typical Operating Characteristics (continued)

($V_{CC} = 5V$, $T_A = +25^\circ C$, unless otherwise noted.)

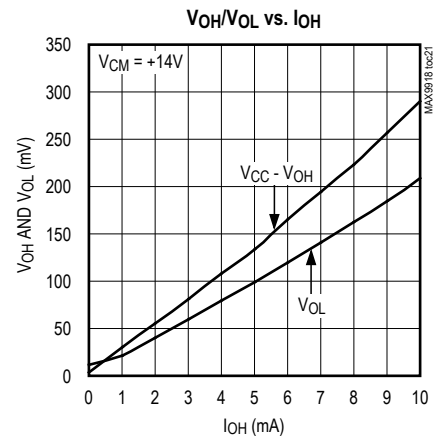
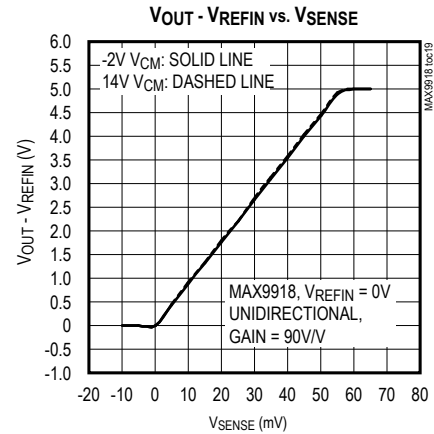
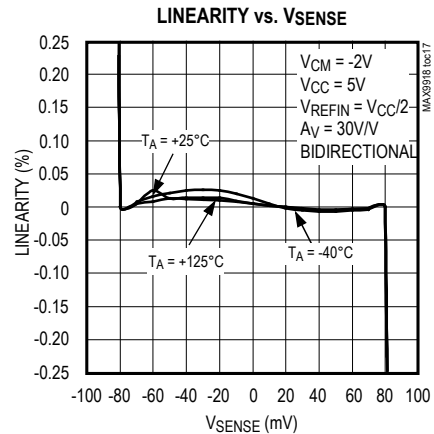

Typical Operating Characteristics (continued)

($V_{CC} = 5V$, $T_A = +25^\circ C$, unless otherwise noted.)

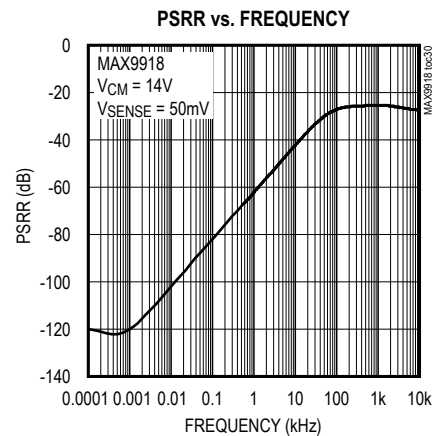
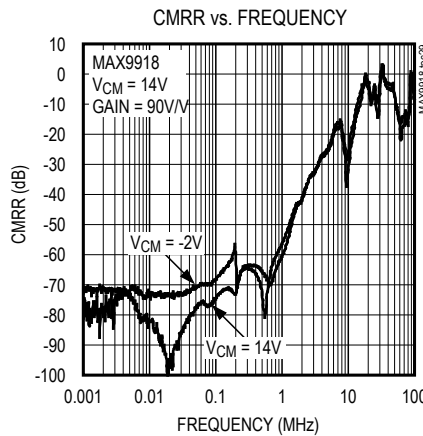
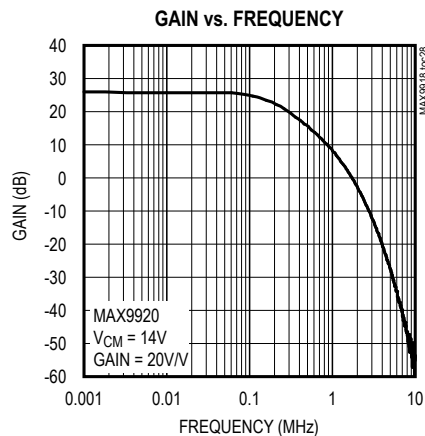
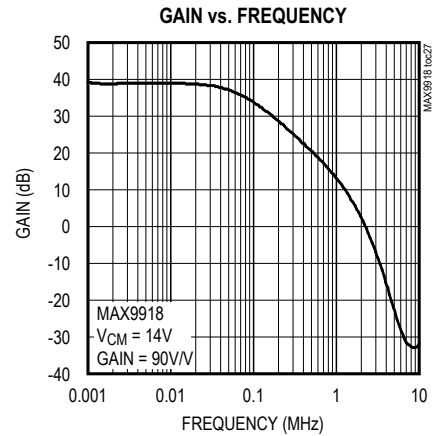
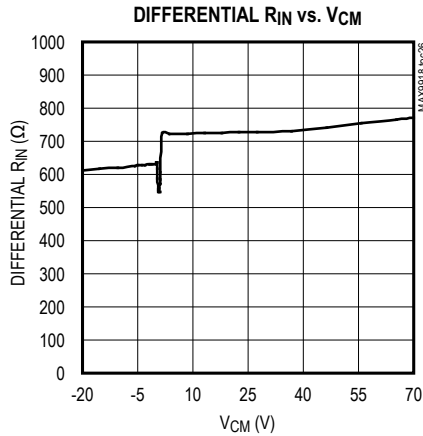
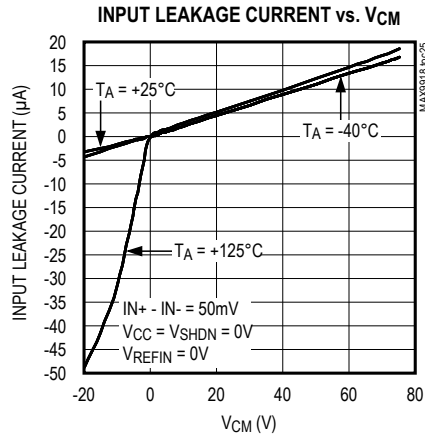
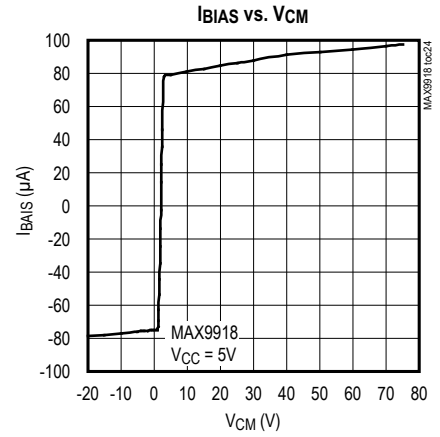
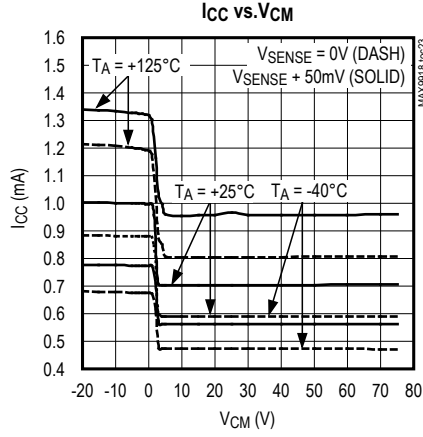
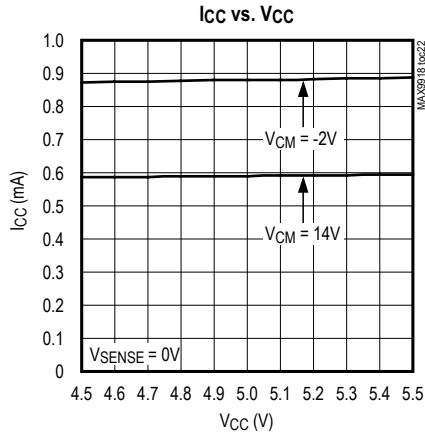

Typical Operating Characteristics (continued)

($V_{CC} = 5V$, $T_A = +25^\circ C$, unless otherwise noted.)

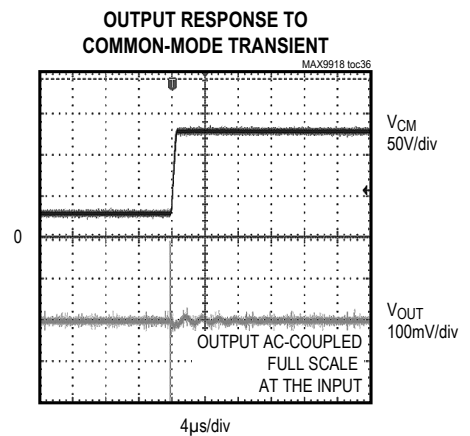
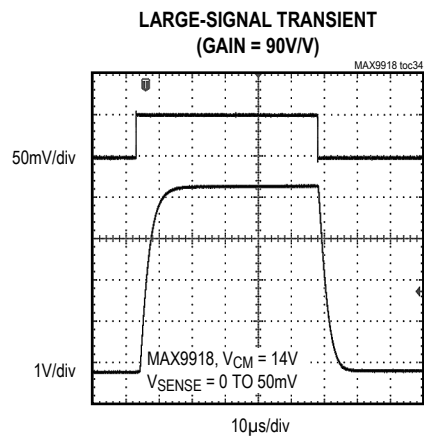
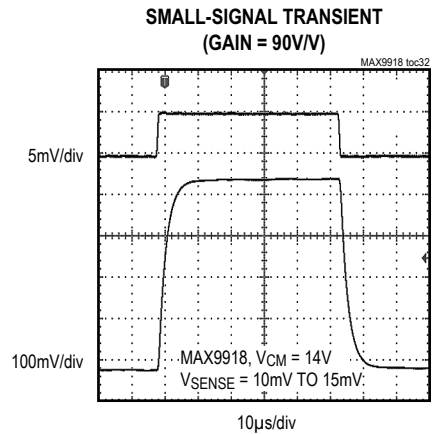
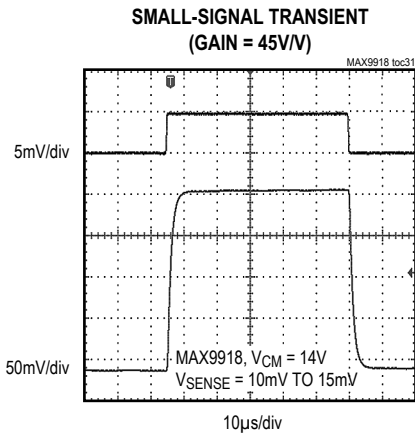

Typical Operating Characteristics (continued)

($V_{CC} = 5V$, $T_A = +25^\circ C$, unless otherwise noted.)

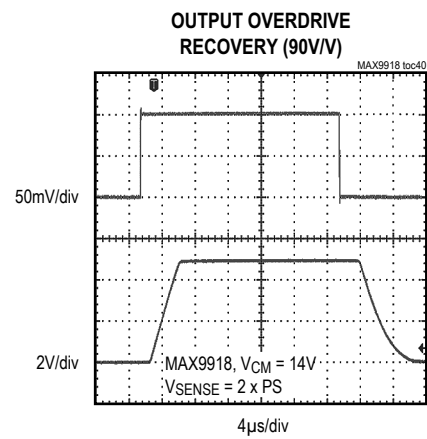
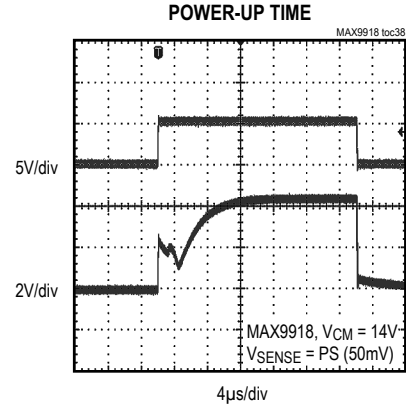

MAX9918/MAX9919/MAX9920

-20V to +75V Input Range,
Precision Uni-/Bidirectional,
Current-Sense Amplifiers

Pin Configuration

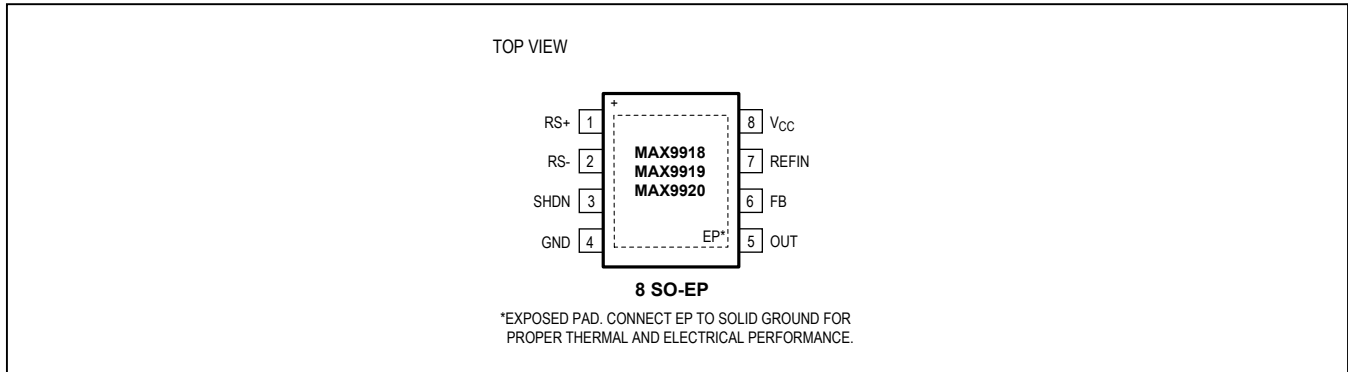

Pin Description

PIN	NAME	FUNCTION
1	RS+	Positive Current-Sensing Input. Power side connects to external sense resistor.
2	RS-	Negative Current-Sensing Input. Load side connects to external sense resistor.
3	SHDN	Active-High Shutdown Input. Connect to GND for normal operation.
4	GND	Ground
5	OUT	Current-Sense Output. V_{OUT} is proportional to V_{SENSE} .
6	FB	Feedback Input. Connect FB to a resistive-divider network to set the gain for the MAX9918 and MAX9920. See the <i>Adjustable Gain (MAX9918/MAX9920)</i> section for more information. Leave FB unconnected for the MAX9919 for proper operation.
7	REFIN	Reference Input. Set REFIN to $V_{CC}/2$ for bidirectional operation. Set REFIN to GND for unidirectional operation.
8	V _{CC}	5V Supply Voltage Input. Bypass V _{CC} to GND with 0.1μF capacitor.
—	EP	Exposed Pad. Connect to a large-area contiguous ground plane for improved power dissipation. Do not use as the only ground connection for the part.

Detailed Description

The MAX9918/MAX9919/MAX9920 are single-supply, high-accuracy uni-/bidirectional current-sense amplifiers with a high common-mode input range that extends from -20V to +75V. The MAX9918/MAX9919/MAX9920's input stage utilizes a pair of level shifters allowing a wide common-mode operating range when measuring the voltage drop (V_{SENSE}) across the current-sense resistor. The first level shifter accommodates the upper common-mode operating range from +2V to +75V. When the common-mode voltage falls below +2V, the second level shifter is used to accommodate negative voltages down to -20V.

The level shifters translate V_{SENSE} to an internal reference voltage where it is then amplified with an instrumentation amplifier. The instrumentation amplifier configuration provides high precision with input offset voltages of 400μV (max). Indirect feedback of the instrumentation amplifier allows the gain to be adjusted with an external resistive-divider network on the MAX9918/MAX9920. The MAX9919 is a fixed gain device available with laser-trimmed resistors for gains of 45V/V (MAX9919F) and 90V/V (MAX9919N).

The MAX9918/MAX9919 operate with a full-scale sense voltage of 50mV. The input stage of the MAX9920 provides an attenuation factor of 4, enabling a full-scale sense voltage of 200mV.

Uni-/Bidirectional Operation

The MAX9918/MAX9919/MAX9920 support both unidirectional and bidirectional operation. The devices operate in unidirectional mode with $V_{REFIN} = V_{GND}$. The output is then referenced to ground and the output voltage V_{OUT} is proportional to the positive voltage drop (V_{SENSE}) from $RS+$ to $RS-$ (Figure 1).

The MAX9918/MAX9919 operate in bidirectional mode by application of a low-source impedance reference voltage in the $0V$ to $V_{CC} - 1.9V$ range, (typically $V_{CC}/2$), to $REFIN$. For the MAX9920, the reference voltage range is $0V$ to $V_{CC} - 2.4V$ (typically $V_{CC}/2$). The output voltage V_{OUT} relative to V_{REFIN} is then proportional to the $\pm V_{SENSE}$ voltage drop from $RS+$ to $RS-$ (Figure 2).



Figure 1. Unidirectional Operation



Figure 2. Bidirectional Operation

Shutdown Mode

Drive SHDN high to enter low-power shutdown mode. In shutdown mode, the MAX9918/MAX9919/MAX9920 draw 0.5µA (typ) of quiescent current.

Adjustable Gain (MAX9918/MAX9920)

The MAX9918/MAX9920 feature externally adjustable gain set by a resistive-divider network circuit using resistors R1 and R2 (see the *Functional Diagram*). The gain frequency compensation is set for a minimum gain of 30V/V for the MAX9918 and 7.5V/V for the MAX9920. The gain G for the MAX9918/MAX9920 is given by the following equation:

$$G = \left(1 + \frac{R2}{R1}\right) \text{ (for MAX9918)}$$

and

$$G = \left(\frac{\left(1 + \frac{R2}{R1}\right)}{4}\right) \text{ (for MAX9920)}$$

Applications Information

Component Selection

Ideally, the maximum load current develops the full-scale sense voltage across the current-sense resistor. Choose the gain needed to yield the maximum output voltage required for the application:

$$V_{OUT} = V_{SENSE} \times G$$

where V_{SENSE} is the full-scale sense voltage, 50mV for the MAX9918/MAX9919, or 200mV for the MAX9920 and G is the gain of the device. G is externally adjustable for the MAX9918/MAX9920. The MAX9919 has a fixed gain version of 45V/V (MAX9919F) or 90V/V (MAX9919N).

In unidirectional applications ($V_{REFIN} = 0V$), select the gain of the MAX9918/MAX9920 to utilize the full output range between GND and V_{CC} . In bidirectional applications ($V_{REFIN} = V_{CC}/2$), select the gain to allow an output voltage range of $\pm V_{CC}/2$. V_{OUT} must be at least 100mV from either rail to achieve the rated gain accuracy.

Sense Resistor, R_{SENSE}

Choose R_{SENSE} based on the following criteria:

Accuracy: A high R_{SENSE} value allows lower currents to be measured more accurately. This is because offsets become less significant when the sense voltage is larger. In the linear region ($100mV < V_{OUT} < V_{CC} - 100mV$), there are two components to accuracy: input offset voltage (V_{OS}) and gain error (GE). Use the linear equation to calculate total error:

$$V_{OUT} = (G \pm GE) \times (V_{SENSE} \pm V_{OS})$$

For best performance, select R_{SENSE} to provide approximately 50mV (MAX9918/MAX9919) or 200mV (MAX9920) of sense voltage for the full-scale current in each application. Sense resistors of 5mΩ to 100mΩ are available with 1% accuracy or better.

Efficiency and Power Dissipation

At high current levels, the I^2R losses in R_{SENSE} can be significant. Take this into consideration when choosing the resistor value and its power dissipation (wattage) rating. Also, the sense resistor's value might drift if it is allowed to heat up excessively. The precision V_{OS} of the MAX9918/MAX9919/MAX9920 allows the use of small sense resistors to reduce power dissipation and reduce hot spots.

Inductance: Keep inductance low if I_{SENSE} has a large high-frequency component by using resistors with low inductance value.

Power-Supply Bypassing and Grounding

Bypass the MAX9918/MAX9919/MAX9920's V_{CC} to ground with a 0.1µF capacitor. Grounding these devices requires no special precautions; follow the same cautionary steps that apply to the rest of the system. High-current systems can experience large voltage drops across a ground plane, and this drop may add to or subtract from V_{OUT} . Using a differential measurement between OUT and REFIN prevents this problem. For highest current-measurement accuracy, use a single-point star ground. Connect the exposed pad to a solid ground to ensure optimal thermal performance.

Functional Diagram

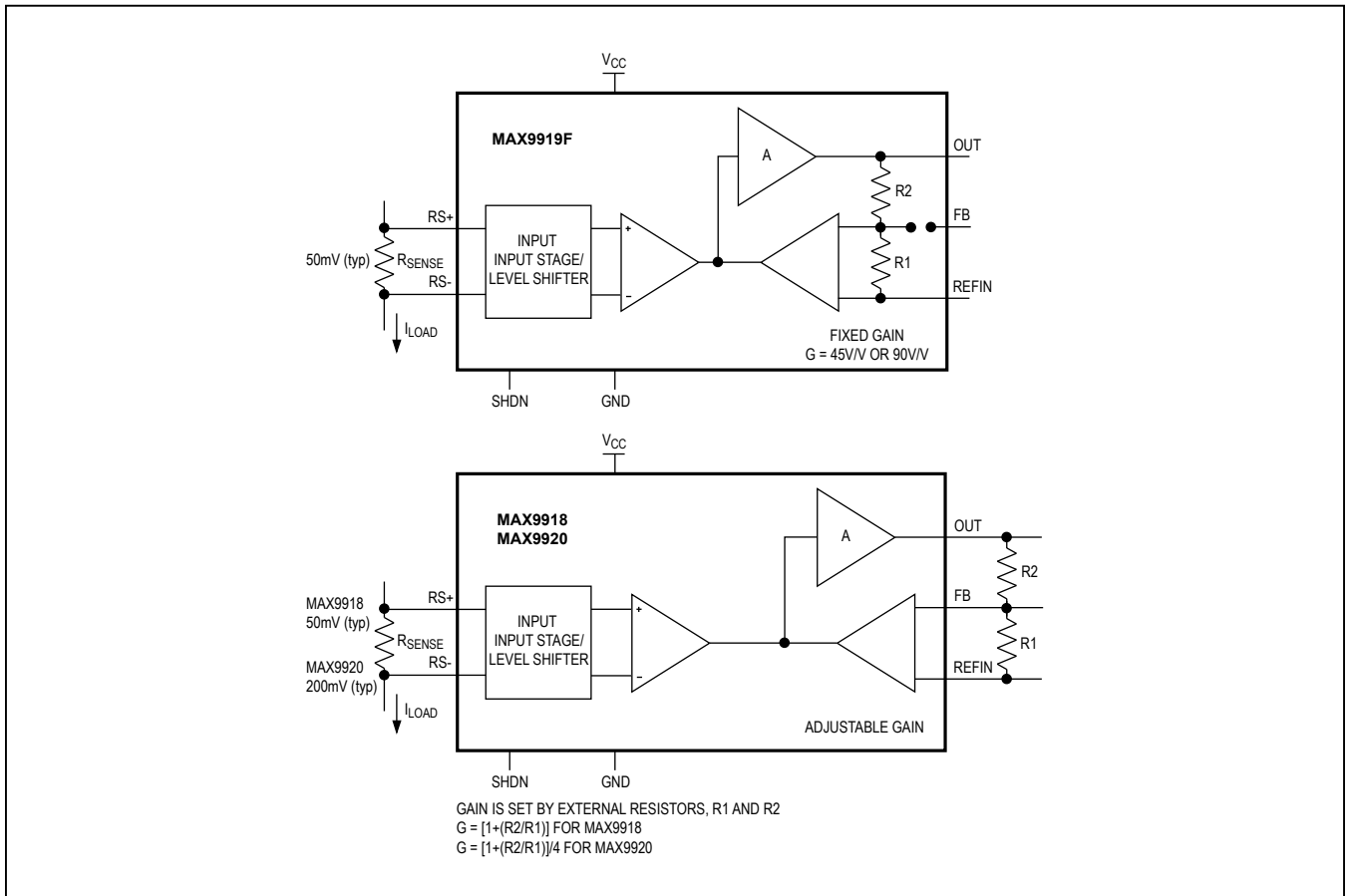

Chip Information

PROCESS: BiCMOS

MAX9918/MAX9919/MAX9920

-20V to +75V Input Range,
Precision Uni-/Bidirectional,
Current-Sense Amplifiers

Package Information

For the latest package outline information and land patterns (footprints), go to www.maximintegrated.com/packages. Note that a "+", "#", or "-" in the package code indicates RoHS status only. Package drawings may show a different suffix character, but the drawing pertains to the package regardless of RoHS status.

PACKAGE TYPE	PACKAGE CODE	OUTLINE NO.	LAND PATTERN NO.
8 SO-EP	S8E+14	21-0111	90-0151

Revision History

REVISION NUMBER	REVISION DATE	DESCRIPTION	PAGES CHANGED
0	10/09	Initial release	—
1	1/10	Updated <i>Functional Diagram</i>	16
2	12/10	Added automotive qualified part	1
3	6/11	Added MAX9920ASA/V+ to data sheet	1
4	7/11	Added automotive qualified parts for the MAX9919NASA/V+ and the MAX9920ASA/V+	1
5	1/13	Added automotive qualified part for the MAX9919FASA/V+	1
6	1/15	Updated <i>Applications and Benefits and Features</i> section	1
7	1/17	Added <i>Junction-to-Case Thermal Resistance</i> specification to <i>Package Thermal Characteristics</i> section	2
8	9/17	Added AEC-Q100 qualification statement to <i>Benefits and Features</i> section	1
9	2/19	Updated <i>Applications, Benefits and Features</i> , and added <i>Package Information</i>	1, 2
10	7/19	Updated TOC29	11

For pricing, delivery, and ordering information, please visit Maxim Integrated's online storefront at <https://www.maximintegrated.com/en/storefront/storefront.html>.

Maxim Integrated cannot assume responsibility for use of any circuitry other than circuitry entirely embodied in a Maxim Integrated product. No circuit patent licenses are implied. Maxim Integrated reserves the right to change the circuitry and specifications without notice at any time. The parametric values (min and max limits) shown in the Electrical Characteristics table are guaranteed. Other parametric values quoted in this data sheet are provided for guidance.

Компания «Океан Электроники» предлагает заключение долгосрочных отношений при поставках импортных электронных компонентов на взаимовыгодных условиях!

Наши преимущества:

- Поставка оригинальных импортных электронных компонентов напрямую с производств Америки, Европы и Азии, а так же с крупнейших складов мира;
- Широкая линейка поставок активных и пассивных импортных электронных компонентов (более 30 млн. наименований);
- Поставка сложных, дефицитных, либо снятых с производства позиций;
- Оперативные сроки поставки под заказ (от 5 рабочих дней);
- Экспресс доставка в любую точку России;
- Помощь Конструкторского Отдела и консультации квалифицированных инженеров;
- Техническая поддержка проекта, помощь в подборе аналогов, поставка прототипов;
- Поставка электронных компонентов под контролем ВП;
- Система менеджмента качества сертифицирована по Международному стандарту ISO 9001;
- При необходимости вся продукция военного и аэрокосмического назначения проходит испытания и сертификацию в лаборатории (по согласованию с заказчиком);
- Поставка специализированных компонентов военного и аэрокосмического уровня качества (Xilinx, Altera, Analog Devices, Intersil, Interpoint, Microsemi, Actel, Aeroflex, Peregrine, VPT, Syfer, Eurofarad, Texas Instruments, MS Kennedy, Miteq, Cobham, E2V, MA-COM, Hittite, Mini-Circuits, General Dynamics и др.);

Компания «Океан Электроники» является официальным дистрибьютором и эксклюзивным представителем в России одного из крупнейших производителей разъемов военного и аэрокосмического назначения «**JONHON**», а так же официальным дистрибьютором и эксклюзивным представителем в России производителя высокотехнологичных и надежных решений для передачи СВЧ сигналов «**FORSTAR**».



JONHON

«**JONHON**» (основан в 1970 г.)

Разъемы специального, военного и аэрокосмического назначения:

(Применяются в военной, авиационной, аэрокосмической, морской, железнодорожной, горно- и нефтедобывающей отраслях промышленности)

«**FORSTAR**» (основан в 1998 г.)

ВЧ соединители, коаксиальные кабели,
кабельные сборки и микроволновые компоненты:

(Применяются в телекоммуникациях гражданского и специального назначения, в средствах связи, РЛС, а так же военной, авиационной и аэрокосмической отраслях промышленности).



Телефон: 8 (812) 309-75-97 (многоканальный)

Факс: 8 (812) 320-03-32

Электронная почта: ocean@oceanchips.ru

Web: <http://oceanchips.ru/>

Адрес: 198099, г. Санкт-Петербург, ул. Калинина, д. 2, корп. 4, лит. А