



MICROCHIP MCP14E3/MCP14E4/MCP14E5

4.0A Dual High-Speed Power MOSFET Drivers With Enable

Features

- High Peak Output Current: 4.0A (typical)
- Independent Enable Function for Each Driver Output
- Low Shoot-Through/Cross-Conduction Current in Output Stage
- Wide Input Supply Voltage Operating Range:
 - 4.5V to 18V
- High Capacitive Load Drive Capability:
 - 2200 pF in 15 ns (typical)
 - 5600 pF in 26 ns (typical)
- Short Delay Times: 50 ns (typical)
- Latch-Up Protected: Will Withstand 1.5A Reverse Current
- Logic Input Will Withstand Negative Swing Up To 5V
- Space-Saving Packages:
 - 8-Lead 6x5 DFN, PDIP, SOIC

Applications

- Switch Mode Power Supplies
- Pulse Transformer Drive
- Line Drivers
- Motor and Solenoid Drive

General Description

The MCP14E3/MCP14E4/MCP14E5 devices are a family of 4.0A buffers/MOSFET drivers. Dual-inverting, dual-noninverting, and complementary outputs are standard logic options offered.

The MCP14E3/MCP14E4/MCP14E5 drivers are capable of operating from a 4.5V to 18V single power supply and can easily charge and discharge 2200 pF gate capacitance in under 15 ns (typical). They provide low impedance in both the ON and OFF states to ensure the MOSFET's intended state will not be affected, even by large transients. The MCP14E3/MCP14E4/MCP14E5 inputs may be driven directly from either TTL or CMOS (2.4V to 18V).

Additional control of the MCP14E3/MCP14E4/MCP14E5 outputs is allowed by the use of separate enable functions. The ENB_A and ENB_B pins are active high and are internally pulled up to V_{DD}. The pins maybe left floating for standard operation.

The MCP14E3/MCP14E4/MCP14E5 dual-output 4.0A driver family is offered in both surface-mount and pin-through-hole packages with a -40°C to +125°C temperature rating. The low thermal resistance of the thermally enhanced DFN package allows for greater power dissipation capability for driving heavier capacitive or resistive loads.

These devices are highly latch-up resistant under any conditions within their power and voltage ratings. They are not subject to damage when up to 5V of noise spiking (of either polarity) occurs on the ground pin. They can accept, without damage or logic upset, up to 1.5A of reverse current being forced back into their outputs. All terminals are fully protect against Electrostatic Discharge (ESD) up to 4 kV.

Package Types

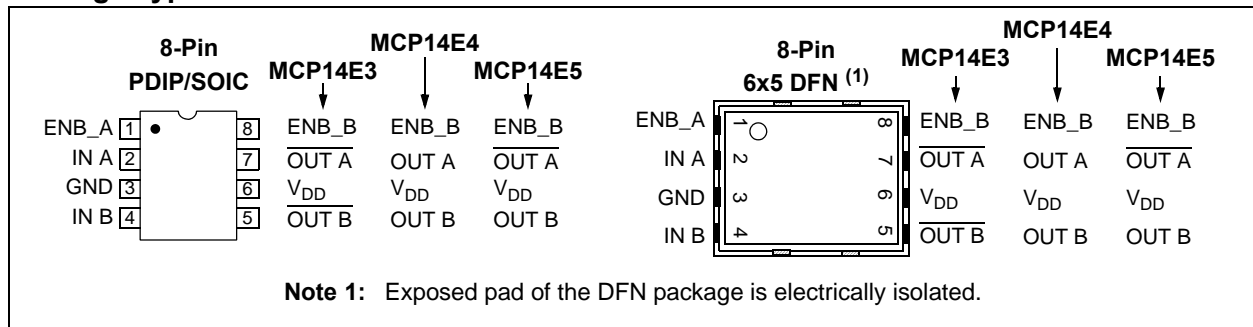

MCP14E3/MCP14E4/MCP14E5

Functional Block Diagram

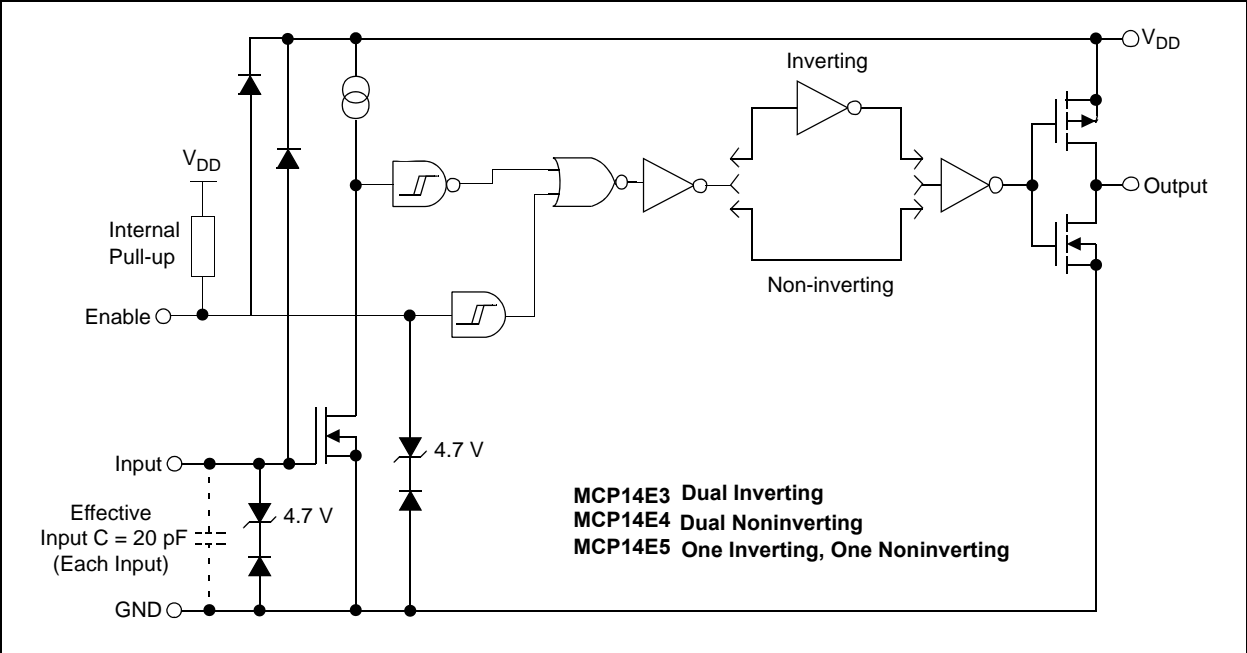

MCP14E3/MCP14E4/MCP14E5

1.0 ELECTRICAL CHARACTERISTICS

Absolute Maximum Ratings †

Supply Voltage	+20V
Input Voltage	(V _{DD} + 0.3V) to (GND - 5V)
Enable Voltage	(V _{DD} + 0.3V) to (GND - 5V)
Input Current (V _{IN} >V _{DD}).....	50 mA
Package Power Dissipation (T _A = 50°C)	
8L-DFN	Note 3
8L-PDIP	1.10W
8L-SOIC	665 mW

† **Notice:** Stresses above those listed under "Maximum Ratings" may cause permanent damage to the device. This is a stress rating only and functional operation of the device at those or any other conditions above those indicated in the operational sections of this specification is not intended. Exposure to maximum rating conditions for extended periods may affect device reliability.

DC CHARACTERISTICS (NOTE 2)

Electrical Specifications: Unless otherwise indicated, T _A = +25°C, with 4.5V ≤ V _{DD} ≤ 18V.						
Parameters	Sym	Min	Typ	Max	Units	Conditions
Input						
Logic '1', High Input Voltage	V _{IH}	2.4	1.5	—	V	
Logic '0', Low Input Voltage	V _{IL}	—	1.3	0.8	V	
Input Current	I _{IN}	-1	—	1	μA	0V ≤ V _{IN} ≤ V _{DD}
Input Voltage	V _{IN}	-5	—	V _{DD} +0.3	V	
Output						
High Output Voltage	V _{OH}	V _{DD} - 0.025	—	—	V	DC Test
Low Output Voltage	V _{OL}	—	—	0.025	V	DC Test
Output Resistance, High	R _{OH}	—	2.5	3.5	Ω	I _{OUT} = 10 mA, V _{DD} = 18V
Output Resistance, Low	R _{OL}	—	2.5	3.0	Ω	I _{OUT} = 10 mA, V _{DD} = 18V
Peak Output Current	I _{PK}	—	4.0	—	A	V _{DD} = 18V (Note 2)
Latch-Up Protection Withstand Reverse Current	I _{REV}	—	>1.5	—	A	Duty cycle ≤ 2%, t ≤ 300 μs
Switching Time (Note 1)						
Rise Time	t _R	—	15	30	ns	Figure 4-1, Figure 4-2 C _L = 2200 pF
Fall Time	t _F	—	18	30	ns	Figure 4-1, Figure 4-2 C _L = 2200 pF
Propagation Delay Time	t _{D1}	—	46	55	ns	Figure 4-1, Figure 4-2
Propagation Delay Time	t _{D2}	—	50	55	ns	Figure 4-1, Figure 4-2
Enable Function (ENB_A, ENB_B)						
High-Level Input Voltage	V _{EN_H}	1.60	1.90	2.90	V	V _{DD} = 12V, LO to HI Transition
Low-Level Input Voltage	V _{EN_L}	1.30	2.20	2.40	V	V _{DD} = 12V, HI to LO Transition
Hysteresis	V _{HYST}	0.10	0.30	0.60	V	
Enable Leakage Current	I _{ENBL}	40	85	115	μA	V _{DD} = 12V, ENB_A = ENB_B = GND
Propagation Delay Time	t _{D3}	—	60	—	ns	Figure 4-3 (Note 1)
Propagation Delay Time	t _{D4}	—	50	—	ns	Figure 4-3 (Note 1)

Note 1: Switching times ensured by design.

2: Tested during characterization, not production tested.

3: Package power dissipation is dependent on the copper pad area on the PCB.

MCP14E3/MCP14E4/MCP14E5

DC CHARACTERISTICS (NOTE 2) (CONTINUED)

Electrical Specifications: Unless otherwise indicated, $T_A = +25^\circ\text{C}$, with $4.5\text{V} \leq V_{DD} \leq 18\text{V}$.						
Parameters	Sym	Min	Typ	Max	Units	Conditions
Power Supply						
Supply Voltage	V_{DD}	4.5	—	18.0	V	
Supply Current	I_{DD}	—	1.60	2.00	mA	$V_{IN_A} = 3\text{V}$, $V_{IN_B} = 3\text{V}$, $ENB_A = ENB_B = \text{High}$
	I_{DD}	—	0.60	0.90	mA	$V_{IN_A} = 0\text{V}$, $V_{IN_B} = 0\text{V}$, $ENB_A = ENB_B = \text{High}$
	I_{DD}	—	1.20	1.40	mA	$V_{IN_A} = 3\text{V}$, $V_{IN_B} = 0\text{V}$, $ENB_A = ENB_B = \text{High}$
	I_{DD}	—	1.20	1.40	mA	$V_{IN_A} = 0\text{V}$, $V_{IN_B} = 3\text{V}$, $ENB_A = ENB_B = \text{High}$
	I_{DD}	—	1.40	1.80	mA	$V_{IN_A} = 3\text{V}$, $V_{IN_B} = 3\text{V}$, $ENB_A = ENB_B = \text{Low}$
	I_{DD}	—	0.55	0.75	mA	$V_{IN_A} = 0\text{V}$, $V_{IN_B} = 0\text{V}$, $ENB_A = ENB_B = \text{Low}$
	I_{DD}	—	1.00	1.20	mA	$V_{IN_A} = 3\text{V}$, $V_{IN_B} = 0\text{V}$, $ENB_A = ENB_B = \text{Low}$
	I_{DD}	—	1.00	1.20	mA	$V_{IN_A} = 0\text{V}$, $V_{IN_B} = 3\text{V}$, $ENB_A = ENB_B = \text{Low}$

- Note 1:** Switching times ensured by design.
Note 2: Tested during characterization, not production tested.
Note 3: Package power dissipation is dependent on the copper pad area on the PCB.

MCP14E3/MCP14E4/MCP14E5

DC CHARACTERISTICS (OVER OPERATING TEMPERATURE RANGE)

Electrical Specifications: Unless otherwise indicated, operating temperature range with $4.5V \leq V_{DD} \leq 18V$.						
Parameters	Sym	Min	Typ	Max	Units	Conditions
Input						
Logic '1', High Input Voltage	V_{IH}	2.4	—	—	V	
Logic '0', Low Input Voltage	V_{IL}	—	—	0.8	V	
Input Current	I_{IN}	-10	—	+10	μA	$0V \leq V_{IN} \leq V_{DD}$
Output						
High Output Voltage	V_{OH}	$V_{DD} - 0.025$	—	—	V	DC TEST
Low Output Voltage	V_{OL}	—	—	0.025	V	DC TEST
Output Resistance, High	R_{OH}	—	3.0	6.0	Ω	$I_{OUT} = 10 \text{ mA}$, $V_{DD} = 18V$
Output Resistance, Low	R_{OL}	—	3.0	5.0	Ω	$I_{OUT} = 10 \text{ mA}$, $V_{DD} = 18V$
Switching Time (Note 1)						
Rise Time	t_R	—	25	40	ns	Figure 4-1, Figure 4-2 $C_L = 2200 \text{ pF}$
Fall Time	t_F	—	28	40	ns	Figure 4-1, Figure 4-2 $C_L = 2200 \text{ pF}$
Delay Time	t_{D1}	—	50	70	ns	Figure 4-1, Figure 4-2
Delay Time	t_{D2}	—	50	70	ns	Figure 4-1, Figure 4-2
Enable Function (ENB_A, ENB_B)						
High-Level Input Voltage	V_{EN_H}	1.60	2.20	2.90	V	$V_{DD} = 12V$, LO to HI Transition
Low-Level Input Voltage	V_{EN_L}	1.30	1.80	2.40	V	$V_{DD} = 12V$, HI to LO Transition
Hysteresis	V_{HYST}	—	0.40	—	V	
Enable Leakage Current	I_{ENBL}	40	87	115	μA	$V_{DD} = 12V$, ENB_A = ENB_B = GND
Propagation Delay Time	t_{D3}	—	50	—	ns	Figure 4-3
Propagation Delay Time	t_{D4}	—	60	—	ns	Figure 4-3
Power Supply						
Supply Voltage	V_{DD}	4.5	—	18.0	V	
Supply Current	I_{DD}	—	2.0	3.0	mA	$V_{IN_A} = 3V$, $V_{IN_B} = 3V$, ENB_A = ENB_B = High
	I_{DD}	—	0.8	1.1	mA	$V_{IN_A} = 0V$, $V_{IN_B} = 0V$, ENB_A = ENB_B = High
	I_{DD}	—	1.5	2.0	mA	$V_{IN_A} = 3V$, $V_{IN_B} = 0V$, ENB_A = ENB_B = High
	I_{DD}	—	1.5	2.0	mA	$V_{IN_A} = 0V$, $V_{IN_B} = 3V$, ENB_A = ENB_B = High
	I_{DD}	—	1.8	2.8	mA	$V_{IN_A} = 3V$, $V_{IN_B} = 3V$, ENB_A = ENB_B = Low
	I_{DD}	—	0.6	0.8	mA	$V_{IN_A} = 0V$, $V_{IN_B} = 0V$, ENB_A = ENB_B = Low
	I_{DD}	—	1.1	1.8	mA	$V_{IN_A} = 3V$, $V_{IN_B} = 0V$, ENB_A = ENB_B = Low
	I_{DD}	—	1.1	1.8	mA	$V_{IN_A} = 0V$, $V_{IN_B} = 3V$, ENB_A = ENB_B = Low

Note 1: Switching times ensured by design.

MCP14E3/MCP14E4/MCP14E5

TEMPERATURE CHARACTERISTICS

Electrical Specifications: Unless otherwise noted, all parameters apply with $4.5V \leq V_{DD} \leq 18V$.						
Parameters	Sym	Min	Typ	Max	Units	Conditions
Temperature Ranges						
Specified Temperature Range	T_A	-40	—	+125	°C	
Maximum Junction Temperature	T_J	—	—	+150	°C	
Storage Temperature Range	T_A	-65	—	+150	°C	
Package Thermal Resistances						
Thermal Resistance, 8L-6x5 DFN	θ_{JA}	—	35.7	—	°C/W	Typical four-layer board with vias to ground plane
Thermal Resistance, 8L-PDIP	θ_{JA}	—	89.3	—	°C/W	
Thermal Resistance, 8L-SOIC	θ_{JA}	—	149.5	—	°C/W	

MCP14E3/MCP14E4/MCP14E5

2.0 TYPICAL PERFORMANCE CURVES

Note: The graphs and tables provided following this note are a statistical summary based on a limited number of samples and are provided for informational purposes only. The performance characteristics listed herein are not tested or guaranteed. In some graphs or tables, the data presented may be outside the specified operating range (e.g., outside specified power supply range) and therefore outside the warranted range.

Note: Unless otherwise indicated, $T_A = +25^\circ\text{C}$ with $4.5\text{V} \leq V_{DD} \leq 18\text{V}$.

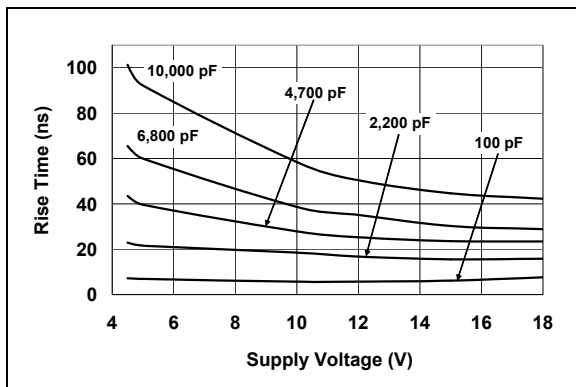

FIGURE 2-1: Rise Time vs. Supply Voltage.

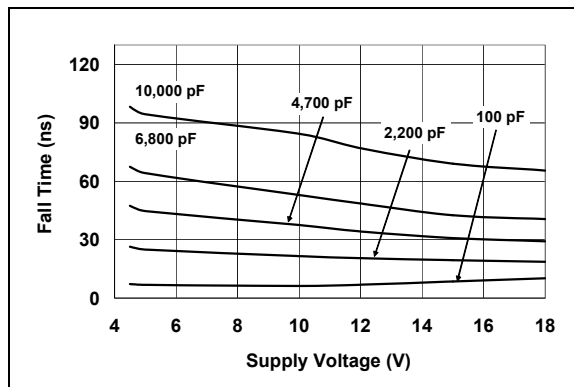

FIGURE 2-4: Fall Time vs. Supply Voltage.

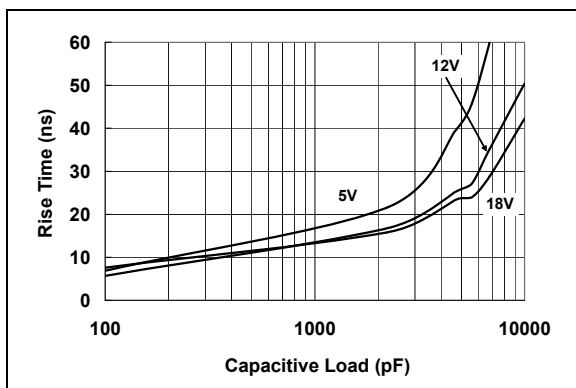

FIGURE 2-2: Rise Time vs. Capacitive Load.

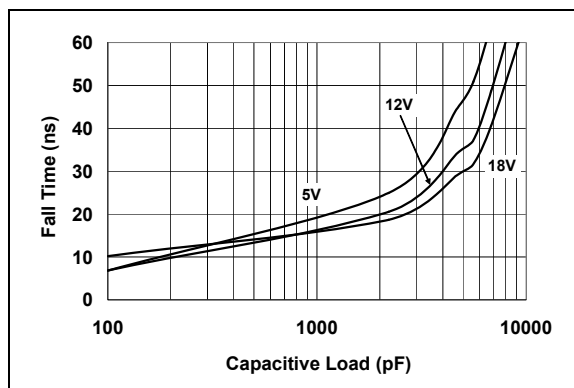

FIGURE 2-5: Fall Time vs. Capacitive Load.

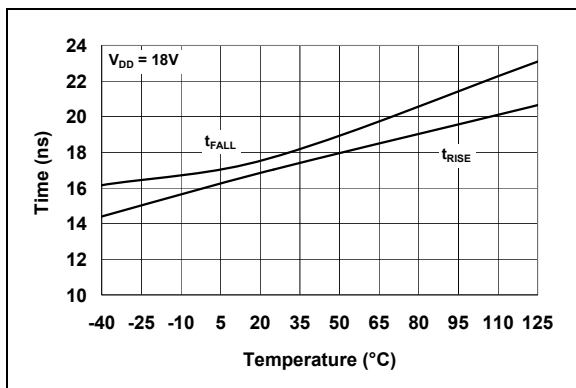

FIGURE 2-3: Rise and Fall Times vs. Temperature.

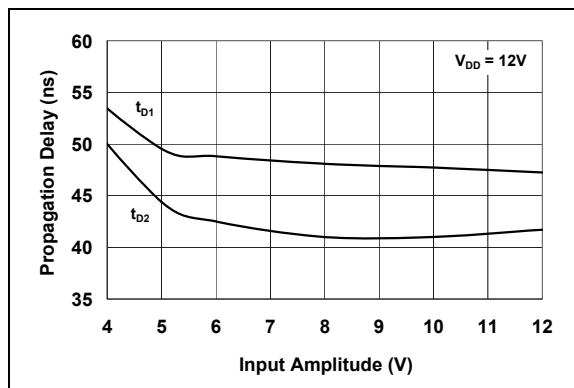

FIGURE 2-6: Propagation Delay vs. Input Amplitude.

MCP14E3/MCP14E4/MCP14E5

Typical Performance Curves (Continued)

Note: Unless otherwise indicated, $T_A = +25^\circ\text{C}$ with $4.5\text{V} \leq V_{DD} \leq 18\text{V}$.

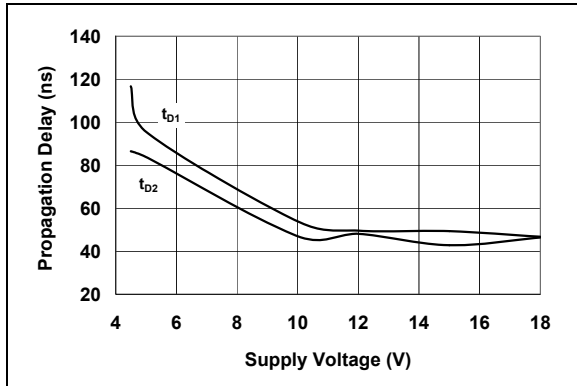

FIGURE 2-7: Propagation Delay Time vs. Supply Voltage.

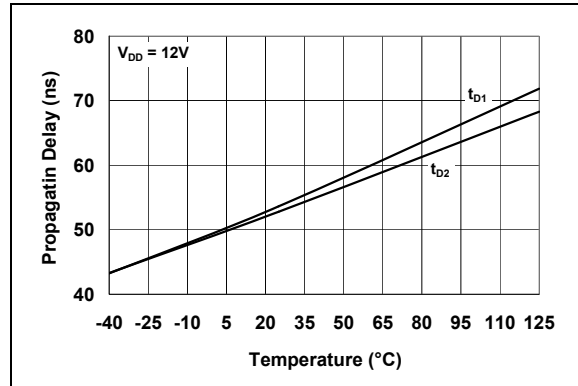

FIGURE 2-10: Propagation Delay Time vs. Temperature.

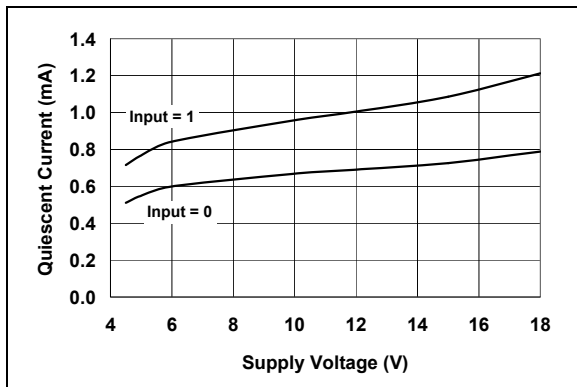

FIGURE 2-8: Quiescent Current vs. Supply Voltage.

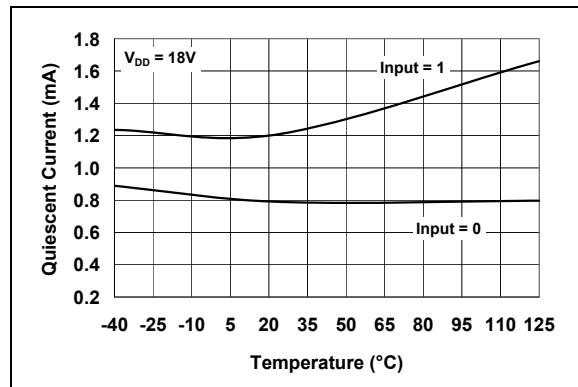

FIGURE 2-11: Quiescent Current vs. Temperature.

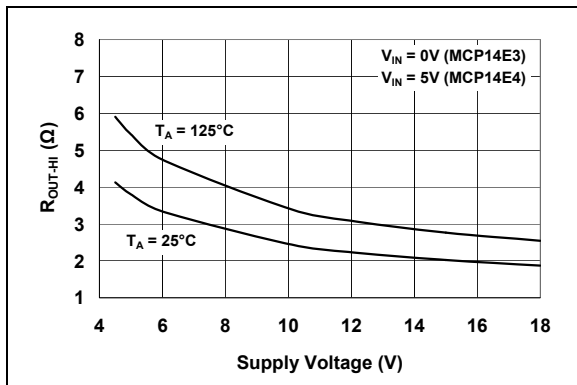

FIGURE 2-9: Output Resistance (Output High) vs. Supply Voltage.

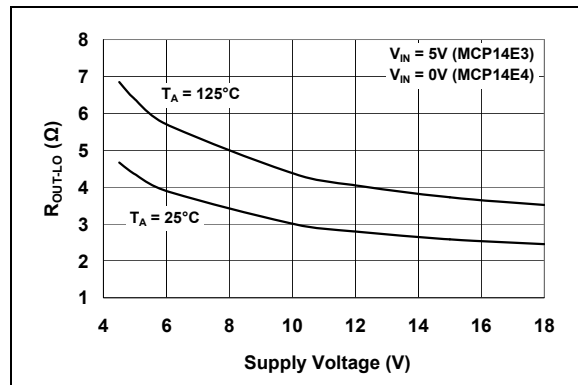

FIGURE 2-12: Output Resistance (Output Low) vs. Supply Voltage.

MCP14E3/MCP14E4/MCP14E5

Typical Performance Curves (Continued)

Note: Unless otherwise indicated, $T_A = +25^\circ\text{C}$ with $4.5\text{V} \leq V_{DD} \leq 18\text{V}$.

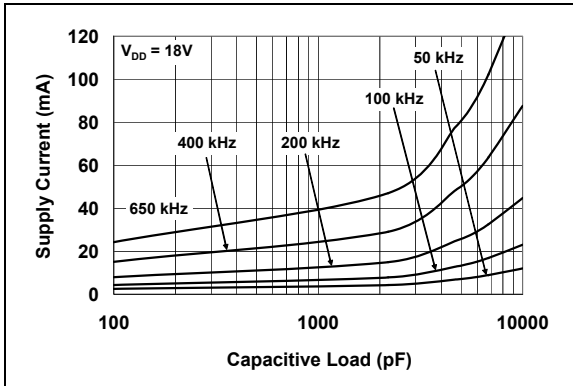

FIGURE 2-13: Supply Current vs. Capacitive Load.

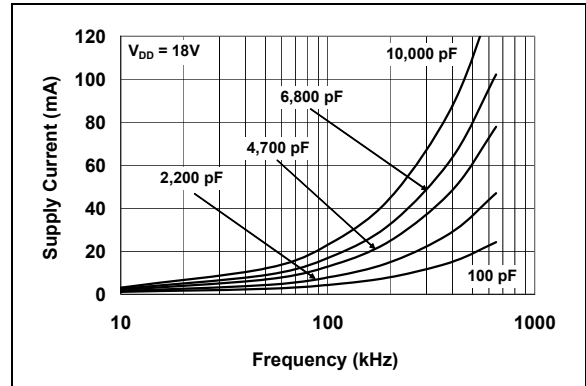

FIGURE 2-16: Supply Current vs. Frequency.

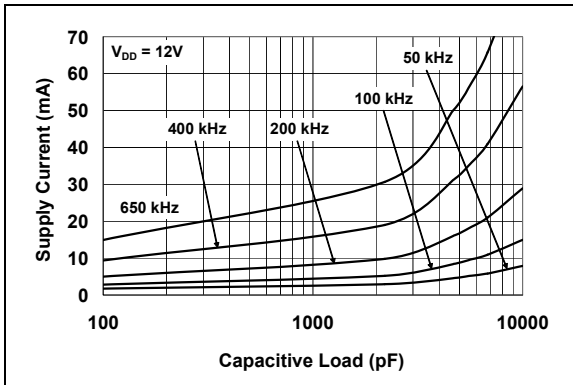

FIGURE 2-14: Supply Current vs. Capacitive Load.

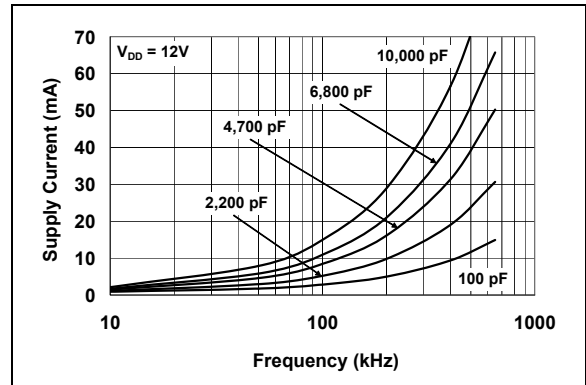

FIGURE 2-17: Supply Current vs. Frequency.

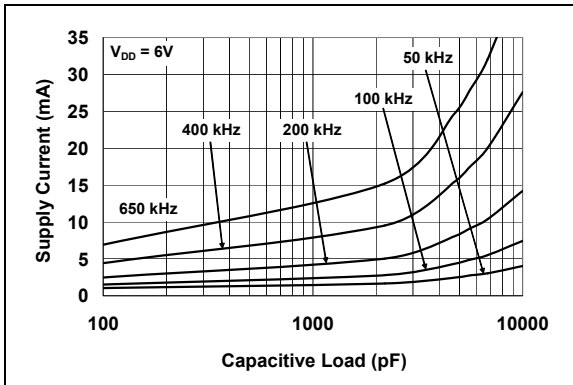

FIGURE 2-15: Supply Current vs. Capacitive Load.

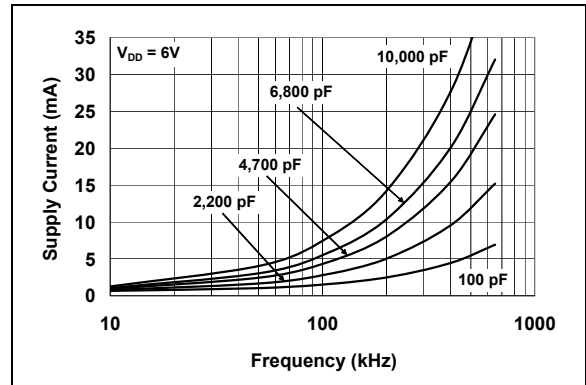

FIGURE 2-18: Supply Current vs. Frequency.

MCP14E3/MCP14E4/MCP14E5

Typical Performance Curves (Continued)

Note: Unless otherwise indicated, $T_A = +25^\circ\text{C}$ with $4.5\text{V} \leq V_{DD} \leq 18\text{V}$.

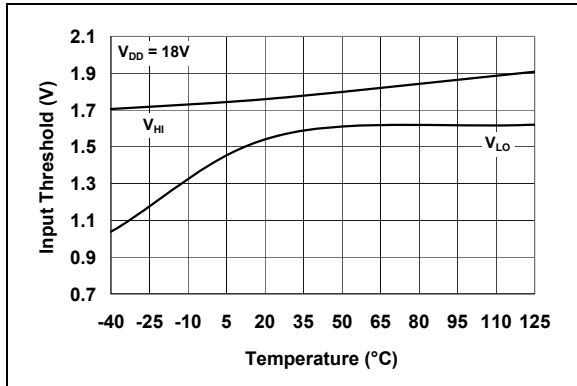

FIGURE 2-19: Input Threshold vs. Temperature.

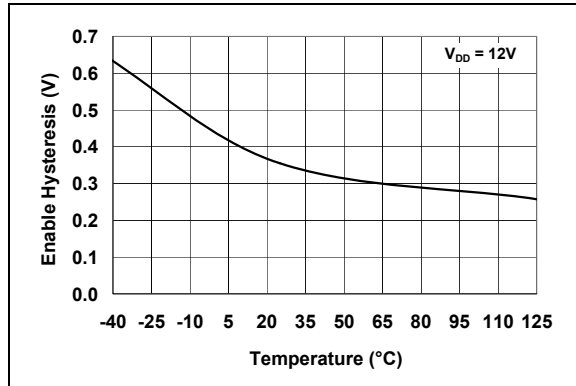

FIGURE 2-22: Enable Hysteresis vs. Temperature.

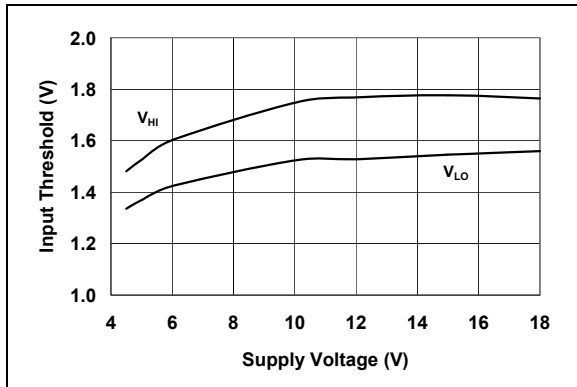
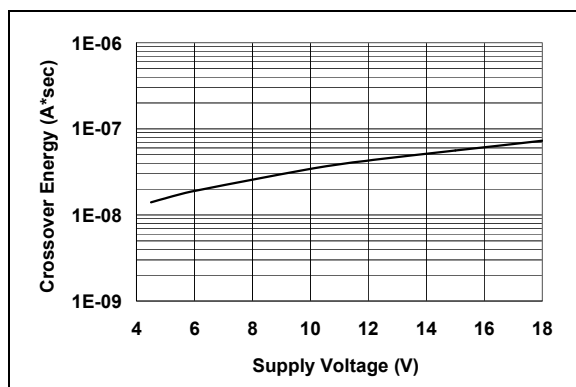

FIGURE 2-20: Input Threshold vs. Supply Voltage.



Note: The values on this graph represent the loss seen by both drivers in a package during one complete cycle. For a single driver, divide the stated value by 2. For a signal transition of a single driver, divide the state value by 4.

FIGURE 2-23: Crossover Energy vs. Supply Voltage.

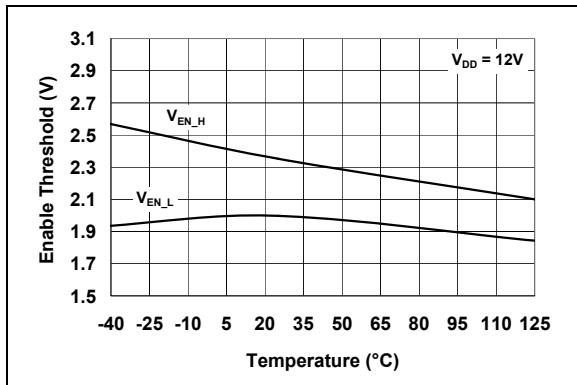

FIGURE 2-21: Enable Threshold vs. Temperature.

MCP14E3/MCP14E4/MCP14E5

3.0 PIN DESCRIPTIONS

The descriptions of the pins are listed in [Table 3-1](#).

TABLE 3-1: PIN FUNCTION TABLE

8-Pin PDIP, SOIC	8-Pin 6x5 DFN	Symbol	Description
1	1	ENB_A	Output A Enable
2	2	IN A	Input A
3	3	GND	Ground
4	4	IN B	Input B
5	5	OUT B	Output B
6	6	V _{DD}	Supply Input
7	7	OUT A	Output A
8	8	ENB_B	Output B Enable
—	PAD	NC	Exposed Metal Pad

Note: Duplicate pins must be connected for proper operation.

3.1 Control Inputs A and B

The MOSFET driver inputs are a high-impedance TTL/CMOS compatible input. The inputs also have hysteresis between the high and low input levels, allowing them to be driven from slow rising and falling signals and to provide noise immunity.

3.2 Outputs A and B

Outputs A and B are CMOS push-pull outputs that are capable of sourcing and sinking 4.0A of peak current (V_{DD} = 18V). The low output impedance ensures the gate of the MOSFET will stay in the intended state even during large transients. These outputs also have a reverse latch-up rating of 1.5A.

3.3 Supply Input (V_{DD})

V_{DD} is the bias supply input for the MOSFET driver and has a voltage range of 4.5V to 18V. This input must be decoupled to ground with a local ceramic capacitor. This bypass capacitor provides a localized low-impedance path for the peak currents that are to be provided to the load.

3.4 Ground (GND)

Ground is the device return pin. The ground pin(s) should have a low impedance connection to the bias supply source return. High peak currents will flow out the ground pin(s) when the capacitive load is being discharged.

3.5 Enable A (ENB_A)

The ENB_A pin is the enable control for Output A. This enable pin is internally pulled up to V_{DD} for active high operation and can be left floating for standard operation. When the ENB_A pin is pulled below the enable pin Low Level Input Voltage (V_{EN_L}), Output A will be in the off state regardless of the input pin state.

3.6 Enable B (ENB_B)

The ENB_B pin is the enable control for Output B. This enable pin is internally pulled up to V_{DD} for active high operation and can be left floating for standard operation. When the ENB_B pin is pulled below the enable pin Low-Level Input Voltage (V_{EN_L}), Output B will be in the off state regardless of the input pin state.

3.7 DFN Exposed Pad

The exposed metal pad of the DFN package is not internally connected to any potential. Therefore, this pad can be connected to a ground plane or other copper plane on a printed circuit board to aid in heat removal from the package.

MCP14E3/MCP14E4/MCP14E5

4.0 APPLICATION INFORMATION

4.1 General Information

MOSFET drivers are high-speed, high current devices which are intended to source/sink high peak currents to charge/discharge the gate capacitance of external MOSFETs or IGBTs. In high frequency switching power supplies, the PWM controller may not have the drive capability to directly drive the power MOSFET. A MOSFET driver like the MCP14E3/MCP14E4/MCP14E5 family can be used to provide additional source/sink current capability.

An additional degree of control has been added to the MCP14E3/MCP14E4/MCP14E5 family. There are separate enable functions for each driver that allow for the immediate termination of the output pulse regardless of the state of the input signal.

4.2 MOSFET Driver Timing

The ability of a MOSFET driver to transition from a fully off state to a fully on state are characterized by the drivers rise time (t_R), fall time (t_F), and propagation delays (t_{D1} and t_{D2}). The MCP14E3/MCP14E4/MCP14E5 family of drivers can typically charge and discharge a 2200 pF load capacitance in 15 ns along with a typical matched propagation delay of 50 ns. [Figure 4-1](#) and [Figure 4-2](#) show the test circuit and timing waveform used to verify the MCP14E3/MCP14E4/MCP14E5 timing.

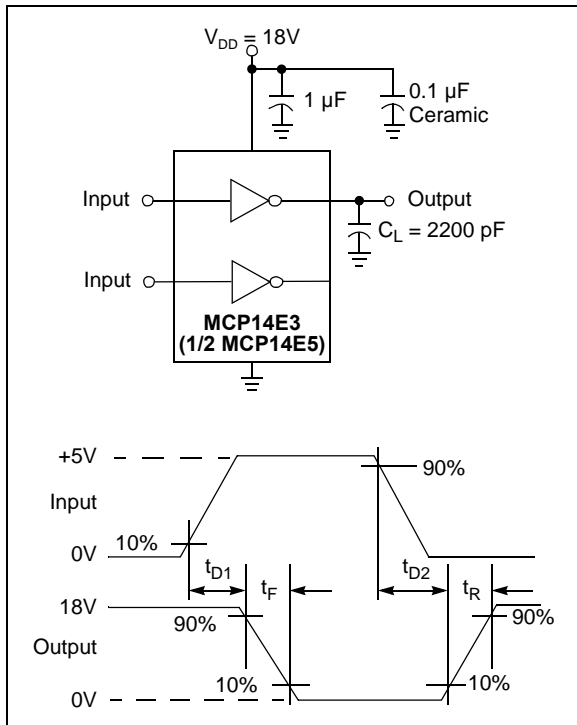

FIGURE 4-1: Inverting Driver Timing Waveform.

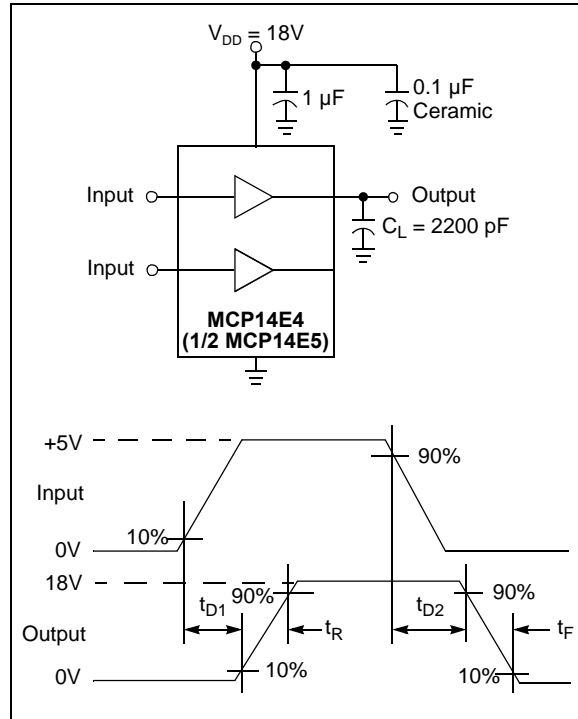

FIGURE 4-2: Non-Inverting Driver Timing Waveform.

4.3 Enable Function

The ENB_A and ENB_B enable pins allow for independent control of OUT A and OUT B respectively. They are active high and are internally pulled up to V_{DD} so that the default state is to enable the driver. These pins can be left floating for normal operation.

When an enable pin voltage is above the enable pin high threshold voltage, V_{EN_H} (2.4V typical), that driver output is enabled and allowed to react to changes in the INPUT pin voltage state. Likewise, when the enable pin voltage falls below the enable pin low threshold voltage, V_{EN_L} (2.0V typical), that driver output is disabled and does not respond to the changes in the INPUT pin voltage state. When the driver is disabled, the output goes to a low state. Refer to [Table 4-1](#) for enable pin logic. The threshold voltages of the enable function are compatible with logic levels. Hysteresis is provided to help increase the noise immunity of the enable function, avoiding false triggers of the enable signal during driver switching. For robust designs, it is recommended that the slew rate of the enable pin signal be greater than 1 V/ns.

There are propagation delays associated with the driver receiving an enable signal and the output reacting. These propagation delays, t_{D3} and t_{D4} , are graphically represented in [Figure 4-3](#).

MCP14E3/MCP14E4/MCP14E5

TABLE 4-1: ENABLE PIN LOGIC

ENB_A	ENB_B	IN A	IN B	MCP14E3		MCP14E4		MCP14E5	
				OUT A	OUT B	OUT A	OUT B	OUT A	OUT B
H	H	H	H	L	L	H	H	L	H
H	H	H	L	L	H	H	L	L	L
H	H	L	H	H	L	L	H	H	H
H	H	L	L	H	H	L	L	H	L
L	L	X	X	L	L	L	L	L	L

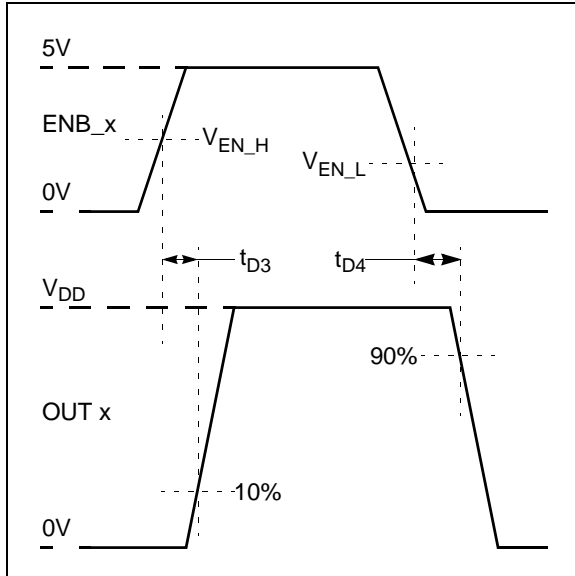

FIGURE 4-3: Enable Timing Waveform.

4.4 Decoupling Capacitors

Careful layout and decoupling capacitors are highly recommended when using MOSFET drivers. Large currents are required to charge and discharge capacitive loads quickly. For example, 2.5A are needed to charge a 2200 pF load with 18V in 16 ns.

To operate the MOSFET driver over a wide frequency range with low supply impedance, a ceramic and low ESR film capacitor are recommended to be placed in parallel between the driver V_{DD} and GND. A 1.0 μ F low ESR film capacitor and a 0.1 μ F ceramic capacitor should be used. These capacitors should be placed close to the driver to minimize circuit board parasitics and provide a local source for the required current.

4.5 PCB Layout Considerations

Proper PCB layout is important in a high current, fast switching circuit to provide proper device operation and robustness of design. PCB trace loop area and inductance should be minimized by the use of ground planes or trace under MOSFET gate drive signals, separate analog and power grounds, and local driver decoupling.

Placing a ground plane beneath the MCP14E3/MCP14E4/MCP14E5 will help as a radiated noise shield as well as providing some heat sinking for power dissipated within the device.

4.6 Power Dissipation

The total internal power dissipation in a MOSFET driver is the summation of three separate power dissipation elements.

EQUATION 4-1:

$$P_T = P_L + P_Q + P_{CC}$$

Where:

P_T	=	Total power dissipation
P_L	=	Load power dissipation
P_Q	=	Quiescent power dissipation
P_{CC}	=	Operating power dissipation

4.6.1 CAPACITIVE LOAD DISSIPATION

The power dissipation caused by a capacitive load is a direct function of frequency, total capacitive load, and supply voltage. The power lost in the MOSFET driver for a complete charging and discharging cycle of a MOSFET is:

EQUATION 4-2:

$$P_L = f \times C_T \times V_{DD}^2$$

Where:

f	=	Switching frequency
C_T	=	Total load capacitance
V_{DD}	=	MOSFET driver supply voltage

MCP14E3/MCP14E4/MCP14E5

4.6.2 QUIESCENT POWER DISSIPATION

The power dissipation associated with the quiescent current draw of the MCP14E3/MCP14E4/MCP14E5 depends upon the state of the input and enable pins. Refer to the DC Characteristic table for the quiescent current draw for specific combinations of input and enable pin states. The quiescent power dissipation is:

EQUATION 4-3:

$$P_Q = (I_{QH} \times D + I_{QL} \times (1 - D)) \times V_{DD}$$

Where:

I_{QH}	=	Quiescent current in the high state
D	=	Duty cycle
I_{QL}	=	Quiescent current in the low state
V_{DD}	=	MOSFET driver supply voltage

4.6.3 OPERATING POWER DISSIPATION

The operating power dissipation occurs each time the MOSFET driver output transitions because for a very short period of time both MOSFETs in the output stage are on simultaneously. This cross-conduction current leads to a power dissipation describes as:

EQUATION 4-4:

$$P_{CC} = CC \times f \times V_{DD}$$

Where:

CC	=	Cross-conduction constant (A*sec)
f	=	Switching frequency
V_{DD}	=	MOSFET driver supply voltage

MCP14E3/MCP14E4/MCP14E5

5.0 PACKAGING INFORMATION

5.1 Package Marking Information (Not to Scale)

8-Lead DFN-S (6x5)

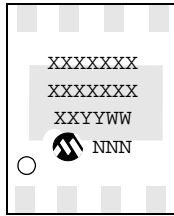

Example:

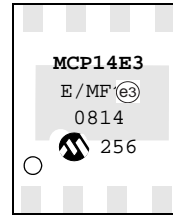

8-Lead PDIP (300 mil)

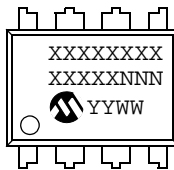

Example:

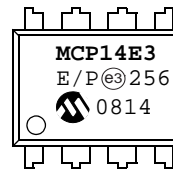

8-Lead SOIC (150 mil)

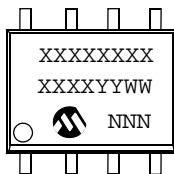

Example:

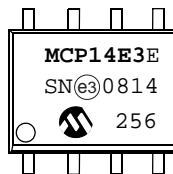

Legend:	XX...X	Customer-specific information
	Y	Year code (last digit of calendar year)
	YY	Year code (last 2 digits of calendar year)
	WW	Week code (week of January 1 is week '01')
	NNN	Alphanumeric traceability code
	(e3)	Pb-free JEDEC designator for Matte Tin (Sn)
	*	This package is Pb-free. The Pb-free JEDEC designator (e3) can be found on the outer packaging for this package.
Note:	In the event the full Microchip part number cannot be marked on one line, it will be carried over to the next line, thus limiting the number of available characters for customer-specific information.	

MCP14E3/MCP14E4/MCP14E5

8-Lead Plastic Dual Flat, No Lead Package (MF) – 6x5 mm Body [DFN-S] PUNCH SINGULATED

Note: For the most current package drawings, please see the Microchip Packaging Specification located at <http://www.microchip.com/packaging>

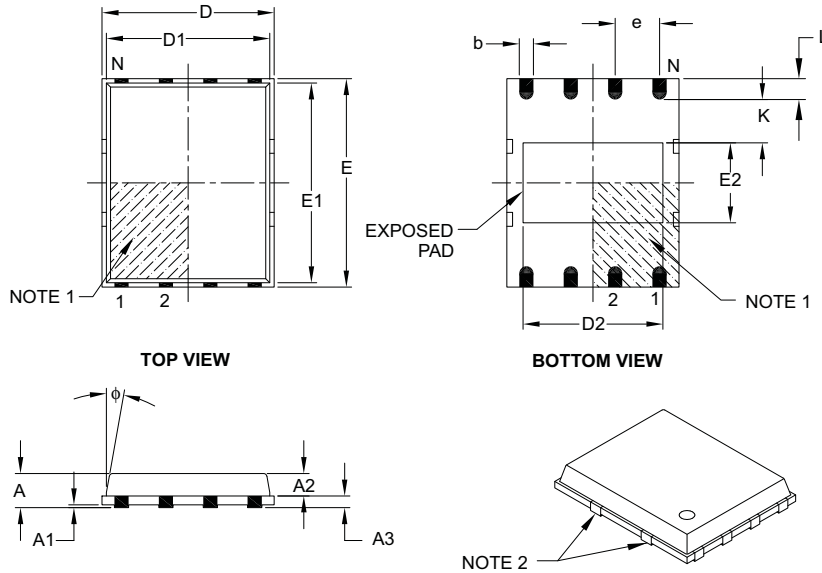

Dimension Limits	Units	MILLIMETERS		
		MIN	NOM	MAX
Number of Pins	N	8		
Pitch	e	1.27 BSC		
Overall Height	A	–	0.85	1.00
Molded Package Thickness	A2	–	0.65	0.80
Standoff	A1	0.00	0.01	0.05
Base Thickness	A3	0.20 REF		
Overall Length	D	4.92 BSC		
Molded Package Length	D1	4.67 BSC		
Exposed Pad Length	D2	3.85	4.00	4.15
Overall Width	E	5.99 BSC		
Molded Package Width	E1	5.74 BSC		
Exposed Pad Width	E2	2.16	2.31	2.46
Contact Width	b	0.35	0.40	0.47
Contact Length	L	0.50	0.60	0.75
Contact-to-Exposed Pad	K	0.20	–	–
Model Draft Angle Top	ϕ	–	–	12°

Notes:

- Pin 1 visual index feature may vary, but must be located within the hatched area.
- Package may have one or more exposed tie bars at ends.
- Dimensioning and tolerancing per ASME Y14.5M.

BSC: Basic Dimension. Theoretically exact value shown without tolerances.

REF: Reference Dimension, usually without tolerance, for information purposes only.

Microchip Technology Drawing C04-113B

MCP14E3/MCP14E4/MCP14E5

8-Lead Plastic Dual In-Line (P) – 300 mil Body [PDIP]

Note: For the most current package drawings, please see the Microchip Packaging Specification located at <http://www.microchip.com/packaging>

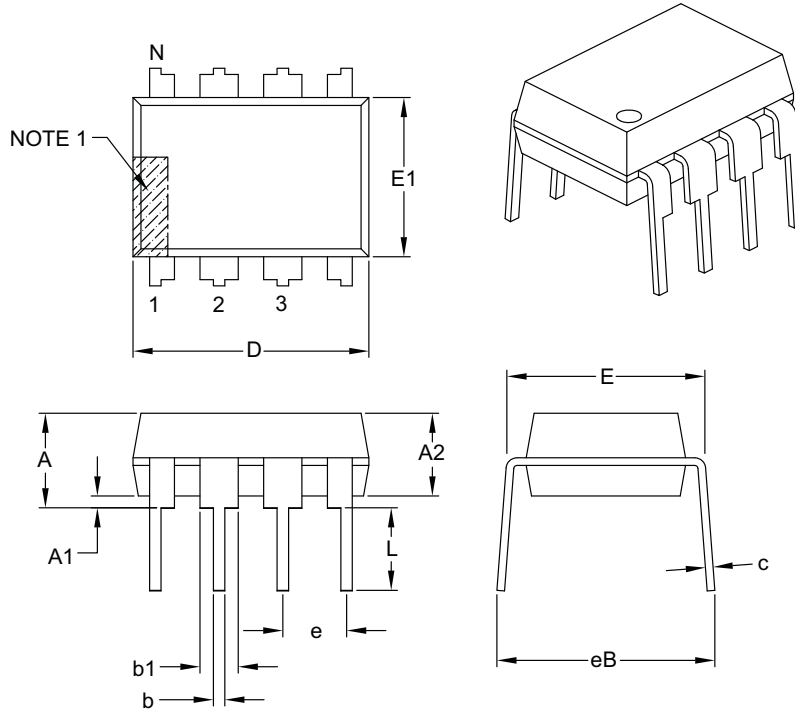

Dimension Limits	Units	INCHES		
		MIN	NOM	MAX
Number of Pins	N	8		
Pitch	e	.100 BSC		
Top to Seating Plane	A	–	–	.210
Molded Package Thickness	A2	.115	.130	.195
Base to Seating Plane	A1	.015	–	–
Shoulder to Shoulder Width	E	.290	.310	.325
Molded Package Width	E1	.240	.250	.280
Overall Length	D	.348	.365	.400
Tip to Seating Plane	L	.115	.130	.150
Lead Thickness	c	.008	.010	.015
Upper Lead Width	b1	.040	.060	.070
Lower Lead Width	b	.014	.018	.022
Overall Row Spacing §	eB	–	–	.430

Notes:

- Pin 1 visual index feature may vary, but must be located with the hatched area.
- § Significant Characteristic.
- Dimensions D and E1 do not include mold flash or protrusions. Mold flash or protrusions shall not exceed .010" per side.
- Dimensioning and tolerancing per ASME Y14.5M.
BSC: Basic Dimension. Theoretically exact value shown without tolerances.

Microchip Technology Drawing C04-018B

MCP14E3/MCP14E4/MCP14E5

8-Lead Plastic Small Outline (SN) – Narrow, 3.90 mm Body [SOIC]

Note: For the most current package drawings, please see the Microchip Packaging Specification located at <http://www.microchip.com/packaging>

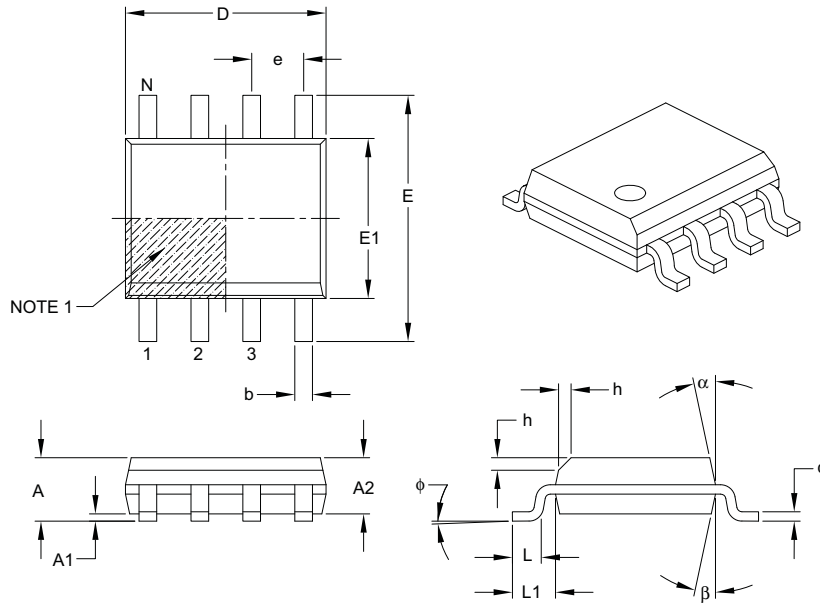

Dimension Limits	Units	MILLIMETERS		
		MIN	NOM	MAX
Number of Pins	N	8		
Pitch	e	1.27 BSC		
Overall Height	A	–	–	1.75
Molded Package Thickness	A2	1.25	–	–
Standoff §	A1	0.10	–	0.25
Overall Width	E	6.00 BSC		
Molded Package Width	E1	3.90 BSC		
Overall Length	D	4.90 BSC		
Chamfer (optional)	h	0.25	–	0.50
Foot Length	L	0.40	–	1.27
Footprint	L1	1.04 REF		
Foot Angle	ϕ	0°	–	8°
Lead Thickness	c	0.17	–	0.25
Lead Width	b	0.31	–	0.51
Mold Draft Angle Top	α	5°	–	15°
Mold Draft Angle Bottom	β	5°	–	15°

Notes:

- Pin 1 visual index feature may vary, but must be located within the hatched area.
- § Significant Characteristic.
- Dimensions D and E1 do not include mold flash or protrusions. Mold flash or protrusions shall not exceed 0.15 mm per side.
- Dimensioning and tolerancing per ASME Y14.5M.

BSC: Basic Dimension. Theoretically exact value shown without tolerances.

REF: Reference Dimension, usually without tolerance, for information purposes only.

Microchip Technology Drawing C04-057B

MCP14E3/MCP14E4/MCP14E5

8-Lead Plastic Small Outline (SN) – Narrow, 3.90 mm Body [SOIC]

Note: For the most current package drawings, please see the Microchip Packaging Specification located at <http://www.microchip.com/packaging>

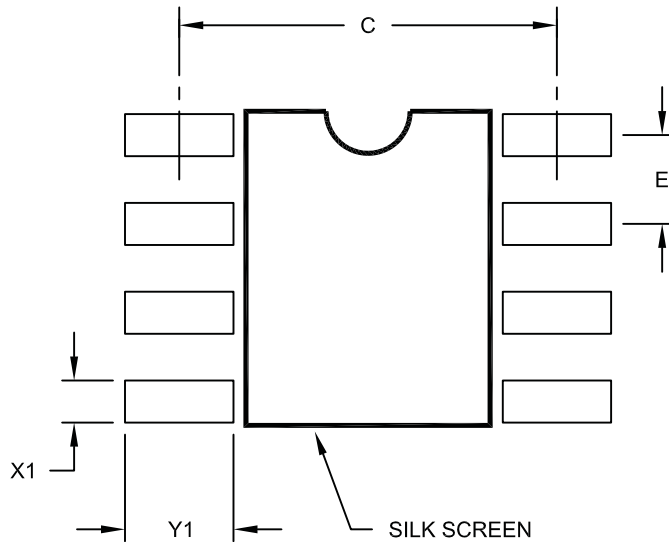

RECOMMENDED LAND PATTERN

Dimension Limits	Units	MILLIMETERS		
		MIN	NOM	MAX
Contact Pitch	E	1.27 BSC		
Contact Pad Spacing	C		5.40	
Contact Pad Width (X8)	X1			0.60
Contact Pad Length (X8)	Y1			1.55

Notes:

1. Dimensioning and tolerancing per ASME Y14.5M

BSC: Basic Dimension. Theoretically exact value shown without tolerances.

Microchip Technology Drawing No. C04-2057A

MCP14E3/MCP14E4/MCP14E5

NOTES:

APPENDIX A: REVISION HISTORY

Revision B (April 2008)

The following is the list of modifications:

1. Correct examples in Product identification System page.

Revision A (September 2007)

- Original Release of this Document.

MCP14E3/MCP14E4/MCP14E5

NOTES:

MCP14E3/MCP14E4/MCP14E5

PRODUCT IDENTIFICATION SYSTEM

To order or obtain information, e.g., on pricing or delivery, refer to the factory or the listed sales office.

<u>PART NO.</u>	<u>X</u>	<u>XX</u>
Device	Temperature Range	Package
<p>Device:</p> <p>MCP14E3: 4.0A Dual MOSFET Driver, Inverting MCP14E3T: 4.0A Dual MOSFET Driver, Inverting Tape and Reel</p> <p>MCP14E4: 4.0A Dual MOSFET Driver, Non-Inverting MCP14E4T: 4.0A Dual MOSFET Driver, Non-Inverting Tape and Reel</p> <p>MCP14E5: 4.0A Dual MOSFET Driver, Complementary MCP14E5T: 4.0A Dual MOSFET Driver, Complementary Tape and Reel</p> <p>Temperature Range: E = -40°C to +125°C</p> <p>Package: *</p> <p>MF = Dual, Flat, No-Lead (6x5 mm Body), 8-lead P = Plastic DIP, (300 mil body), 8-lead SN = Plastic SOIC (150 mil Body), 8-Lead</p> <p>* All package offerings are Pb Free (Lead Free)</p>		
<p>Examples:</p> <p>a) MCP14E3-E/MF: 4.0A Dual Inverting MOSFET Driver, 8LD DFN package.</p> <p>b) MCP14E3-E/P: 4.0A Dual Inverting MOSFET Driver, 8LD PDIP package.</p> <p>c) MCP14E3-E/SN: 4.0A Dual Inverting MOSFET Driver, 8LD SOIC package.</p> <p>a) MCP14E4-E/MF: 4.0A Dual Non-Inverting MOSFET Driver, 8LD DFN package.</p> <p>b) MCP14E4-E/P: 4.0A Dual Non-Inverting MOSFET Driver, 8LD PDIP package.</p> <p>c) MCP14E4T-E/SN: Tape and Reel, 4.0A Dual Non-Inverting MOSFET Driver, 8LD SOIC package.</p> <p>a) MCP14E5T-E/MF: Tape and Reel, 4.0A Dual Complementary MOSFET Driver, 8LD DFN package.</p> <p>b) MCP14E5-E/P: 4.0A Dual Complementary MOSFET Driver, 8LD PDIP package.</p> <p>c) MCP14E5-E/SN: 4.0A Dual Complementary MOSFET Driver, 8LD SOIC package.</p>		

MCP14E3/MCP14E4/MCP14E5

NOTES:

Note the following details of the code protection feature on Microchip devices:

- Microchip products meet the specification contained in their particular Microchip Data Sheet.
- Microchip believes that its family of products is one of the most secure families of its kind on the market today, when used in the intended manner and under normal conditions.
- There are dishonest and possibly illegal methods used to breach the code protection feature. All of these methods, to our knowledge, require using the Microchip products in a manner outside the operating specifications contained in Microchip's Data Sheets. Most likely, the person doing so is engaged in theft of intellectual property.
- Microchip is willing to work with the customer who is concerned about the integrity of their code.
- Neither Microchip nor any other semiconductor manufacturer can guarantee the security of their code. Code protection does not mean that we are guaranteeing the product as “unbreakable.”

Code protection is constantly evolving. We at Microchip are committed to continuously improving the code protection features of our products. Attempts to break Microchip's code protection feature may be a violation of the Digital Millennium Copyright Act. If such acts allow unauthorized access to your software or other copyrighted work, you may have a right to sue for relief under that Act.

Information contained in this publication regarding device applications and the like is provided only for your convenience and may be superseded by updates. It is your responsibility to ensure that your application meets with your specifications. MICROCHIP MAKES NO REPRESENTATIONS OR WARRANTIES OF ANY KIND WHETHER EXPRESS OR IMPLIED, WRITTEN OR ORAL, STATUTORY OR OTHERWISE, RELATED TO THE INFORMATION, INCLUDING BUT NOT LIMITED TO ITS CONDITION, QUALITY, PERFORMANCE, MERCHANTABILITY OR FITNESS FOR PURPOSE. Microchip disclaims all liability arising from this information and its use. Use of Microchip devices in life support and/or safety applications is entirely at the buyer's risk, and the buyer agrees to defend, indemnify and hold harmless Microchip from any and all damages, claims, suits, or expenses resulting from such use. No licenses are conveyed, implicitly or otherwise, under any Microchip intellectual property rights.

Trademarks

The Microchip name and logo, the Microchip logo, Accuron, dsPIC, KEELOQ, KEELOQ logo, MPLAB, PIC, PICmicro, PICSTART, PRO MATE, rPIC and SmartShunt are registered trademarks of Microchip Technology Incorporated in the U.S.A. and other countries.

FilterLab, Linear Active Thermistor, MXDEV, MXLAB, SEEVAL, SmartSensor and The Embedded Control Solutions Company are registered trademarks of Microchip Technology Incorporated in the U.S.A.

Analog-for-the-Digital Age, Application Maestro, CodeGuard, dsPICDEM, dsPICDEM.net, dsPICworks, dsSPEAK, ECAN, ECONOMONITOR, FanSense, In-Circuit Serial Programming, ICSP, ICEPIC, Mindi, MiWi, MPASM, MPLAB Certified logo, MPLIB, MPLINK, mTouch, PICkit, PICDEM, PICDEM.net, PICtail, PIC³² logo, PowerCal, PowerInfo, PowerMate, PowerTool, REAL ICE, rLAB, Select Mode, Total Endurance, UNI/O, WiperLock and ZENA are trademarks of Microchip Technology Incorporated in the U.S.A. and other countries.

SQTP is a service mark of Microchip Technology Incorporated in the U.S.A.

All other trademarks mentioned herein are property of their respective companies.

© 2008, Microchip Technology Incorporated, Printed in the U.S.A., All Rights Reserved.

 Printed on recycled paper.

**QUALITY MANAGEMENT SYSTEM
CERTIFIED BY DNV
== ISO/TS 16949:2002 ==**

Microchip received ISO/TS-16949:2002 certification for its worldwide headquarters, design and wafer fabrication facilities in Chandler and Tempe, Arizona; Gresham, Oregon and design centers in California and India. The Company's quality system processes and procedures are for its PIC[®] MCUs and dsPIC[®] DSCs, KEELOQ[®] code hopping devices, Serial EEPROMs, microperipherals, nonvolatile memory and analog products. In addition, Microchip's quality system for the design and manufacture of development systems is ISO 9001:2000 certified.



WORLDWIDE SALES AND SERVICE

AMERICAS

Corporate Office
2355 West Chandler Blvd.
Chandler, AZ 85224-6199
Tel: 480-792-7200
Fax: 480-792-7277
Technical Support:
<http://support.microchip.com>
Web Address:
www.microchip.com

Atlanta
Duluth, GA
Tel: 678-957-9614
Fax: 678-957-1455

Boston
Westborough, MA
Tel: 774-760-0087
Fax: 774-760-0088

Chicago
Itasca, IL
Tel: 630-285-0071
Fax: 630-285-0075

Dallas
Addison, TX
Tel: 972-818-7423
Fax: 972-818-2924

Detroit
Farmington Hills, MI
Tel: 248-538-2250
Fax: 248-538-2260

Kokomo
Kokomo, IN
Tel: 765-864-8360
Fax: 765-864-8387

Los Angeles
Mission Viejo, CA
Tel: 949-462-9523
Fax: 949-462-9608

Santa Clara
Santa Clara, CA
Tel: 408-961-6444
Fax: 408-961-6445

Toronto
Mississauga, Ontario,
Canada
Tel: 905-673-0699
Fax: 905-673-6509

ASIA/PACIFIC

Asia Pacific Office
Suites 3707-14, 37th Floor
Tower 6, The Gateway
Harbour City, Kowloon
Hong Kong
Tel: 852-2401-1200
Fax: 852-2401-3431

Australia - Sydney
Tel: 61-2-9868-6733
Fax: 61-2-9868-6755

China - Beijing
Tel: 86-10-8528-2100
Fax: 86-10-8528-2104

China - Chengdu
Tel: 86-28-8665-5511
Fax: 86-28-8665-7889

China - Hong Kong SAR
Tel: 852-2401-1200
Fax: 852-2401-3431

China - Nanjing
Tel: 86-25-8473-2460
Fax: 86-25-8473-2470

China - Qingdao
Tel: 86-532-8502-7355
Fax: 86-532-8502-7205

China - Shanghai
Tel: 86-21-5407-5533
Fax: 86-21-5407-5066

China - Shenyang
Tel: 86-24-2334-2829
Fax: 86-24-2334-2393

China - Shenzhen
Tel: 86-755-8203-2660
Fax: 86-755-8203-1760

China - Wuhan
Tel: 86-27-5980-5300
Fax: 86-27-5980-5118

China - Xiamen
Tel: 86-592-2388138
Fax: 86-592-2388130

China - Xian
Tel: 86-29-8833-7252
Fax: 86-29-8833-7256

China - Zhuhai
Tel: 86-756-3210040
Fax: 86-756-3210049

ASIA/PACIFIC

India - Bangalore
Tel: 91-80-4182-8400
Fax: 91-80-4182-8422

India - New Delhi
Tel: 91-11-4160-8631
Fax: 91-11-4160-8632

India - Pune
Tel: 91-20-2566-1512
Fax: 91-20-2566-1513

Japan - Yokohama
Tel: 81-45-471- 6166
Fax: 81-45-471-6122

Korea - Daegu
Tel: 82-53-744-4301
Fax: 82-53-744-4302

Korea - Seoul
Tel: 82-2-554-7200
Fax: 82-2-558-5932 or
82-2-558-5934

Malaysia - Kuala Lumpur
Tel: 60-3-6201-9857
Fax: 60-3-6201-9859

Malaysia - Penang
Tel: 60-4-227-8870
Fax: 60-4-227-4068

Philippines - Manila
Tel: 63-2-634-9065
Fax: 63-2-634-9069

Singapore
Tel: 65-6334-8870
Fax: 65-6334-8850

Taiwan - Hsin Chu
Tel: 886-3-572-9526
Fax: 886-3-572-6459

Taiwan - Kaohsiung
Tel: 886-7-536-4818
Fax: 886-7-536-4803

Taiwan - Taipei
Tel: 886-2-2500-6610
Fax: 886-2-2508-0102

Thailand - Bangkok
Tel: 66-2-694-1351
Fax: 66-2-694-1350

EUROPE

Austria - Wels
Tel: 43-7242-2244-39
Fax: 43-7242-2244-393

Denmark - Copenhagen
Tel: 45-4450-2828
Fax: 45-4485-2829

France - Paris
Tel: 33-1-69-53-63-20
Fax: 33-1-69-30-90-79

Germany - Munich
Tel: 49-89-627-144-0
Fax: 49-89-627-144-44

Italy - Milan
Tel: 39-0331-742611
Fax: 39-0331-466781

Netherlands - Drunen
Tel: 31-416-690399
Fax: 31-416-690340

Spain - Madrid
Tel: 34-91-708-08-90
Fax: 34-91-708-08-91

UK - Wokingham
Tel: 44-118-921-5869
Fax: 44-118-921-5820

Компания «Океан Электроники» предлагает заключение долгосрочных отношений при поставках импортных электронных компонентов на взаимовыгодных условиях!

Наши преимущества:

- Поставка оригинальных импортных электронных компонентов напрямую с производств Америки, Европы и Азии, а так же с крупнейших складов мира;
- Широкая линейка поставок активных и пассивных импортных электронных компонентов (более 30 млн. наименований);
- Поставка сложных, дефицитных, либо снятых с производства позиций;
- Оперативные сроки поставки под заказ (от 5 рабочих дней);
- Экспресс доставка в любую точку России;
- Помощь Конструкторского Отдела и консультации квалифицированных инженеров;
- Техническая поддержка проекта, помощь в подборе аналогов, поставка прототипов;
- Поставка электронных компонентов под контролем ВП;
- Система менеджмента качества сертифицирована по Международному стандарту ISO 9001;
- При необходимости вся продукция военного и аэрокосмического назначения проходит испытания и сертификацию в лаборатории (по согласованию с заказчиком);
- Поставка специализированных компонентов военного и аэрокосмического уровня качества (Xilinx, Altera, Analog Devices, Intersil, Interpoint, Microsemi, Actel, Aeroflex, Peregrine, VPT, Syfer, Eurofarad, Texas Instruments, MS Kennedy, Miteq, Cobham, E2V, MA-COM, Hittite, Mini-Circuits, General Dynamics и др.);

Компания «Океан Электроники» является официальным дистрибьютором и эксклюзивным представителем в России одного из крупнейших производителей разъемов военного и аэрокосмического назначения «JONHON», а так же официальным дистрибьютором и эксклюзивным представителем в России производителя высокотехнологичных и надежных решений для передачи СВЧ сигналов «FORSTAR».



JONHON

«JONHON» (основан в 1970 г.)

Разъемы специального, военного и аэрокосмического назначения:

(Применяются в военной, авиационной, аэрокосмической, морской, железнодорожной, горно- и нефтедобывающей отраслях промышленности)

«FORSTAR» (основан в 1998 г.)

ВЧ соединители, коаксиальные кабели, кабельные сборки и микроволновые компоненты:

(Применяются в телекоммуникациях гражданского и специального назначения, в средствах связи, РЛС, а так же военной, авиационной и аэрокосмической отраслях промышленности).



Телефон: 8 (812) 309-75-97 (многоканальный)

Факс: 8 (812) 320-03-32

Электронная почта: ocean@oceanchips.ru

Web: <http://oceanchips.ru/>

Адрес: 198099, г. Санкт-Петербург, ул. Калинина, д. 2, корп. 4, лит. А