



TIG074E8

N-Channel IGBT 400V, 150A, VCE(sat); 3.8V Single ECH8

ON Semiconductor®

http://onsemi.com

Features

- Low-saturation voltage
- Enhancement type
- Mounting Height 0.9mm, Mounting Area 8.12mm²
- Halogen free compliance
- Low voltage drive (2.5V)
- Built-in Gate to Emitter protection diode
- dv / dt guarantee*

Application

- Light-Controlling Flash Applications

Specifications

Absolute Maximum Ratings at Ta=25°C

Parameter	Symbol	Conditions	P-channel	Unit
Collector to Emitter Voltage	V _{CES}		400	V
Gate to Emitter Voltage (DC)	V _{GES}		±4	V
Gate to Emitter Voltage (Pulse)	V _{GES}	PW≤1ms	±5	V
Collector Current (Pulse)	I _{CP}	V _{GE} =2.5V, C _M =200μF	150	A
Maximum Collector to Emitter dv / dt	dv / dt	Turn off I _C =150A, V _{CE} ≤320V, starting T _{ch} =25°C	400	V / μs
Channel Temperature	T _j		150	°C
Storage Temperature	T _{stg}		-40 to +150	°C

* : Concerning dv / dt (slope of Collector Voltage at the time of Turn-OFF), will be 100% screen-detected in the circuit shown as Fig. 1.

Stresses exceeding Maximum Ratings may damage the device. Maximum Ratings are stress ratings only. Functional operation above the Recommended Operating Conditions is not implied. Extended exposure to stresses above the Recommended Operating Conditions may affect device reliability.

Electrical Characteristics at Ta=25°C

Parameter	Symbol	Conditions	Ratings			Unit
			min	typ	max	
Collector to Emitter Breakdown Voltage	V _{(BR)CES}	I _C =2mA, V _{GE} =0V	400			V
Collector to Emitter Cutoff Current	I _{CES}	V _{CE} =320V, V _{GE} =0V			10	μA
Gate to Emitter Leakage Current	I _{GES}	V _{GE} =±4V, V _{CE} =0V			±10	μA
Gate to Emitter Threshold Voltage	V _{GE(off)}	V _{CE} =10V, I _C =1mA	0.4		0.9	V
Collector to Emitter Saturation Voltage	V _{CE(sat)}	I _C =100A, V _{GE} =2.5V		3.8	5.4	V
Input Capacitance	C _{ies}	V _{CE} =10V, f=1MHz		3100		pF
Output Capacitance	C _{oes}				32	pF
Reverse Transfer Capacitance	C _{res}				24	pF

ORDERING INFORMATION

See detailed ordering and shipping information on page 5 of this data sheet.

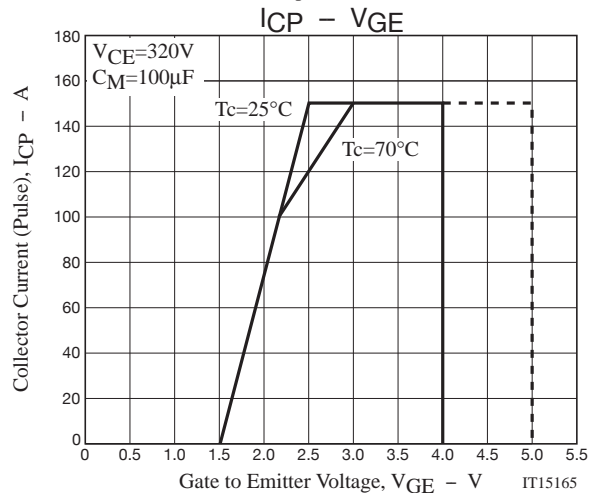
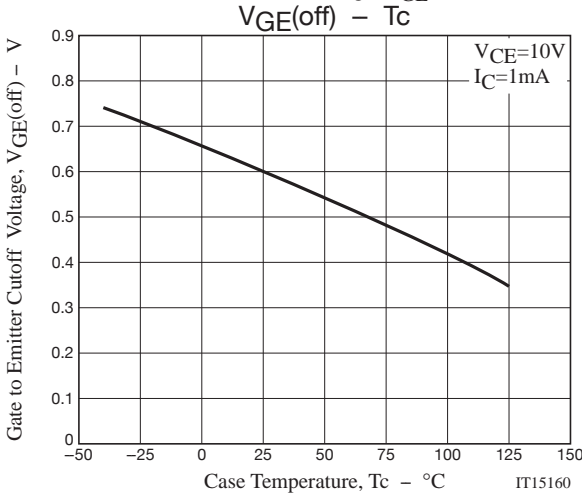
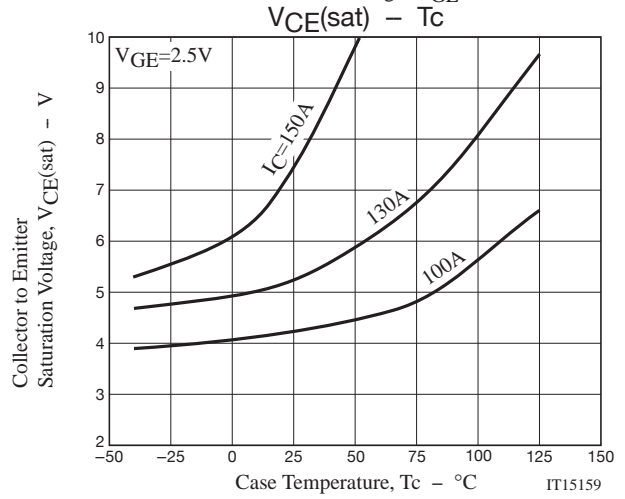
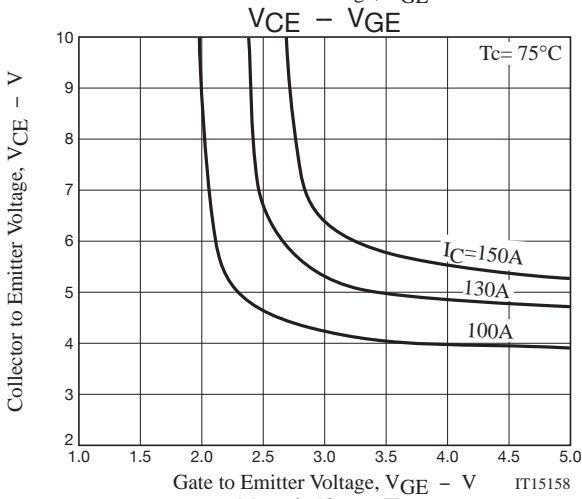
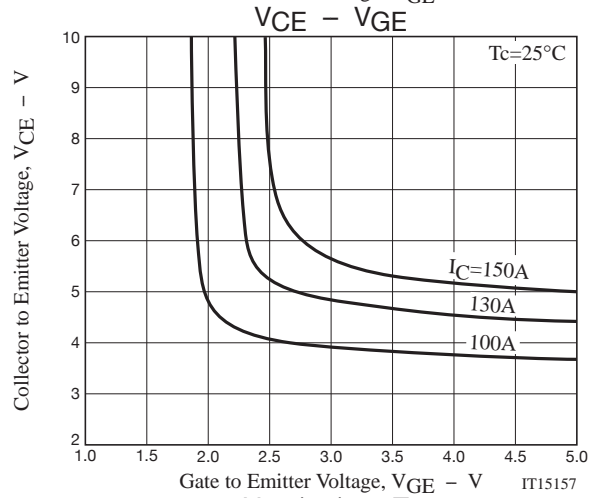
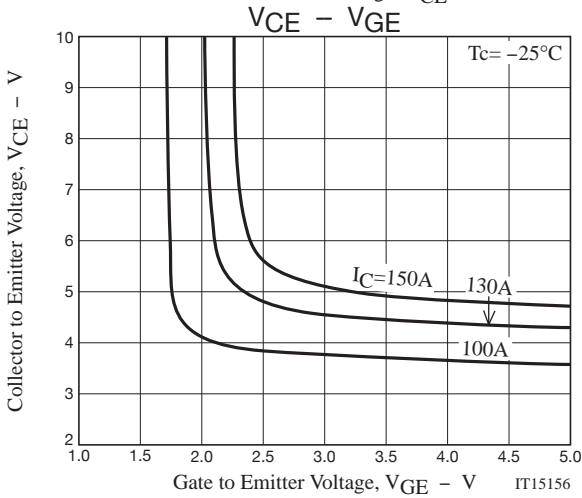
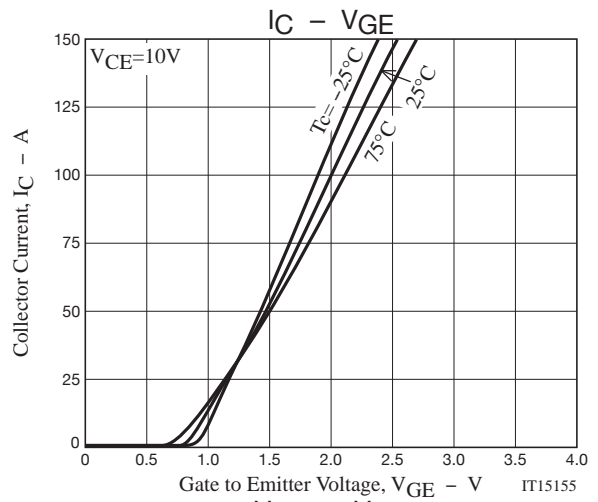
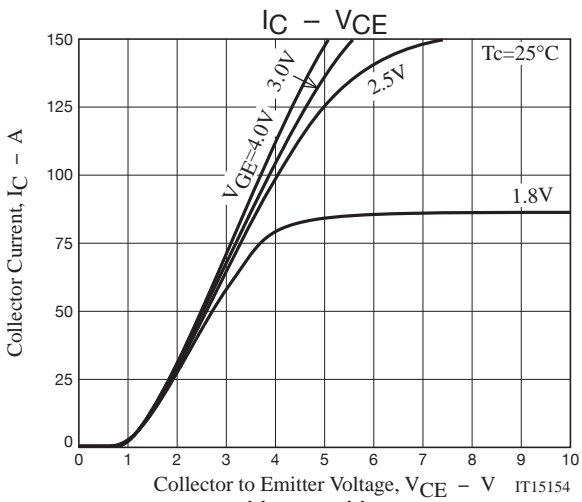

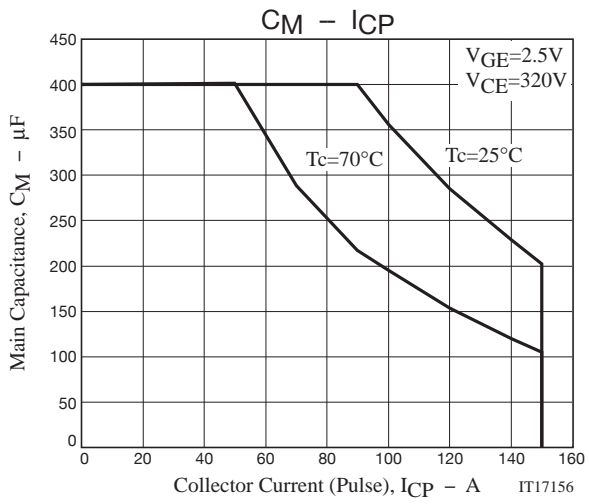
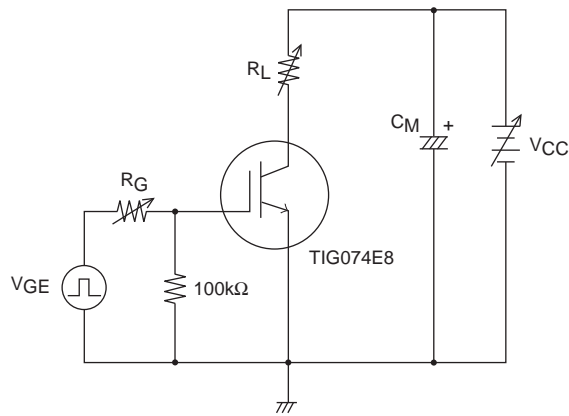

Fig.1 Large Current R Load Switching Circuit



Note1. The collector voltage gradient dv / dt - Turn off I_c safety movement domain to protect the device of Gate-series resistor R_G when it is turned off.

Definition of dv/dt

dv/dt is defined as the maximum slope of the below V_{CE} curve during turn-off period.

$$dv/dt = \Delta V_{CE} / \Delta t = \Delta V_{CE} / 100ns$$

Overall waveform

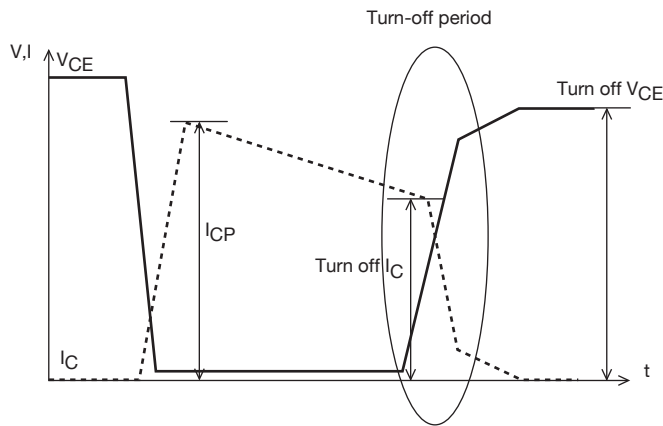

Enlarged picture of turn-off period

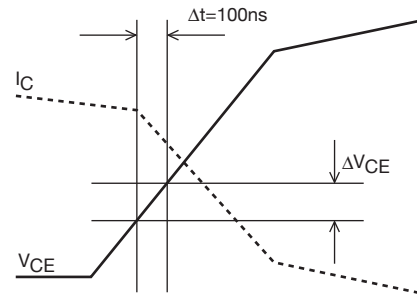

IT15323

Definition of Switching Time

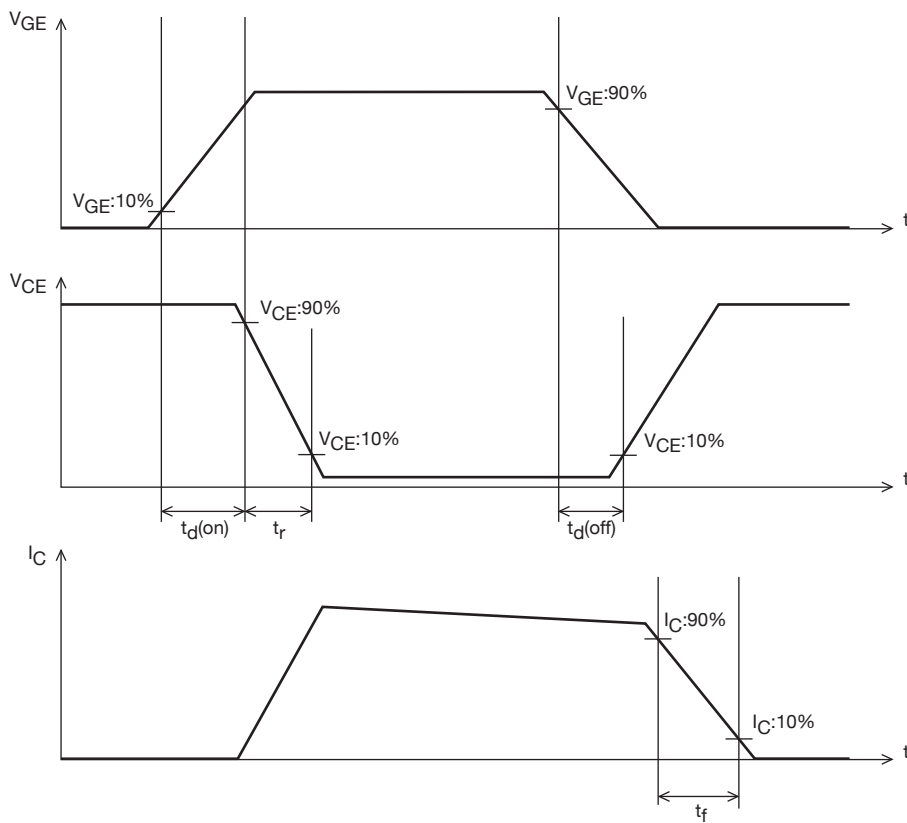

IT15324

TIG074E8

Package Dimensions

TIG074E8-TL-H

SOT-28FL/ECH8
CASE 318BF
ISSUE O

Unit : mm

- 1: Emitter
- 2: Emitter
- 3: Emitter
- 4: Gate
- 5: Collector
- 6: Collector
- 7: Collector
- 8: Collector

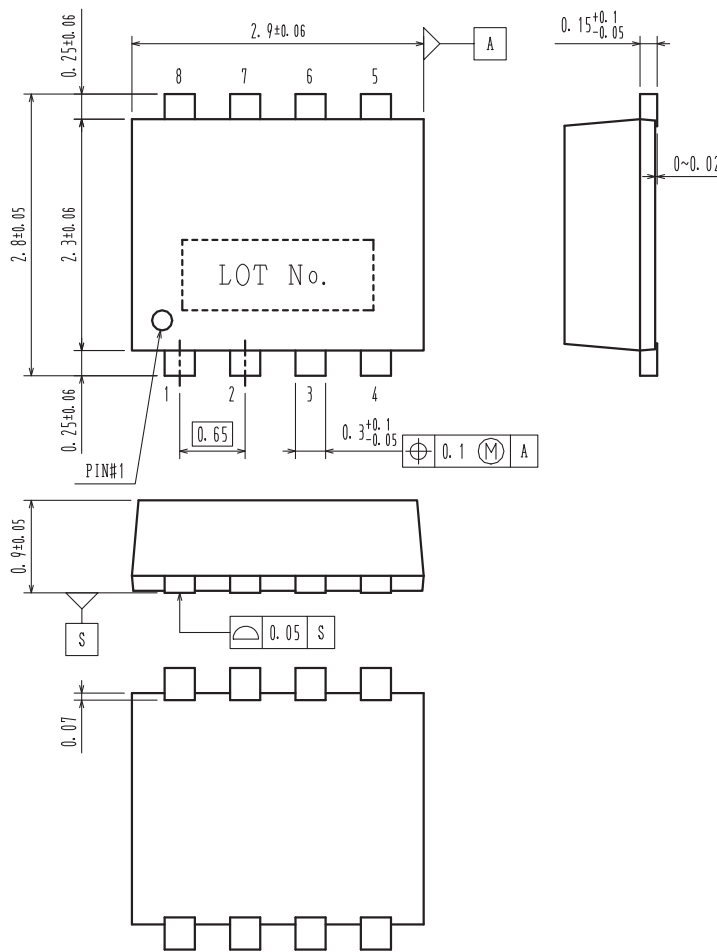

Land Pattern Example

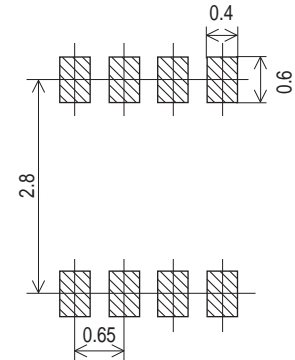

Ordering & Package Information

Device	Package	Shipping	memo
TIG074E8-TL-H	ECH8	3,000 pcs./reel	Pb-Free and Halogen Free

Packing Type: TL

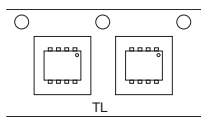

Marking

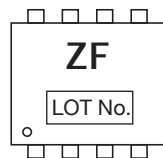

Electrical Connection

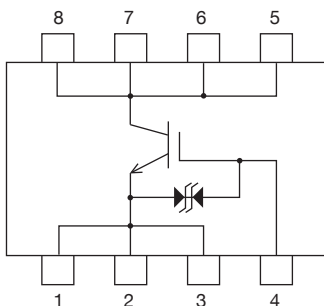

Note on usage : TIG074E8 has protection diode between gate and emitter but handling it requires sufficient care to be taken.

ON Semiconductor and the ON logo are registered trademarks of Semiconductor Components Industries, LLC (SCILLC). SCILLC owns the rights to a number of patents, trademarks, copyrights, trade secrets, and other intellectual property. A listing of SCILLC's product/patent coverage may be accessed at www.onsemi.com/site/pdf/Patent-Marking.pdf. SCILLC reserves the right to make changes without further notice to any products herein. SCILLC makes no warranty, representation or guarantee regarding the suitability of its products for any particular purpose, nor does SCILLC assume any liability arising out of the application or use of any product or circuit, and specifically disclaims any and all liability, including without limitation special, consequential or incidental damages. "Typical" parameters which may be provided in SCILLC data sheets and/or specifications can and do vary in different applications and actual performance may vary over time. All operating parameters, including "Typicals" must be validated for each customer application by customer's technical experts. SCILLC does not convey any license under its patent rights nor the rights of others. SCILLC products are not designed, intended, or authorized for use as components in systems intended for surgical implant into the body, or other applications intended to support or sustain life, or for any other application in which the failure of the SCILLC product could create a situation where personal injury or death may occur. Should Buyer purchase or use SCILLC products for any such unintended or unauthorized application, Buyer shall indemnify and hold SCILLC and its officers, employees, subsidiaries, affiliates, and distributors harmless against all claims, costs, damages, and expenses, and reasonable attorney fees arising out of, directly or indirectly, any claim of personal injury or death associated with such unintended or unauthorized use, even if such claim alleges that SCILLC was negligent regarding the design or manufacture of the part. SCILLC is an Equal Opportunity/Affirmative Action Employer. This literature is subject to all applicable copyright laws and is not for resale in any manner.

Компания «Океан Электроники» предлагает заключение долгосрочных отношений при поставках импортных электронных компонентов на взаимовыгодных условиях!

Наши преимущества:

- Поставка оригинальных импортных электронных компонентов напрямую с производств Америки, Европы и Азии, а так же с крупнейших складов мира;
- Широкая линейка поставок активных и пассивных импортных электронных компонентов (более 30 млн. наименований);
- Поставка сложных, дефицитных, либо снятых с производства позиций;
- Оперативные сроки поставки под заказ (от 5 рабочих дней);
- Экспресс доставка в любую точку России;
- Помощь Конструкторского Отдела и консультации квалифицированных инженеров;
- Техническая поддержка проекта, помощь в подборе аналогов, поставка прототипов;
- Поставка электронных компонентов под контролем ВП;
- Система менеджмента качества сертифицирована по Международному стандарту ISO 9001;
- При необходимости вся продукция военного и аэрокосмического назначения проходит испытания и сертификацию в лаборатории (по согласованию с заказчиком);
- Поставка специализированных компонентов военного и аэрокосмического уровня качества (Xilinx, Altera, Analog Devices, Intersil, Interpoint, Microsemi, Actel, Aeroflex, Peregrine, VPT, Syfer, Eurofarad, Texas Instruments, MS Kennedy, Miteq, Cobham, E2V, MA-COM, Hittite, Mini-Circuits, General Dynamics и др.);

Компания «Океан Электроники» является официальным дистрибьютором и эксклюзивным представителем в России одного из крупнейших производителей разъемов военного и аэрокосмического назначения «JONHON», а так же официальным дистрибьютором и эксклюзивным представителем в России производителя высокотехнологичных и надежных решений для передачи СВЧ сигналов «FORSTAR».



JONHON

«JONHON» (основан в 1970 г.)

Разъемы специального, военного и аэрокосмического назначения:

(Применяются в военной, авиационной, аэрокосмической, морской, железнодорожной, горно- и нефтедобывающей отраслях промышленности)

«FORSTAR» (основан в 1998 г.)

ВЧ соединители, коаксиальные кабели,
кабельные сборки и микроволновые компоненты:

(Применяются в телекоммуникациях гражданского и специального назначения, в средствах связи, РЛС, а так же военной, авиационной и аэрокосмической отраслях промышленности).



Телефон: 8 (812) 309-75-97 (многоканальный)

Факс: 8 (812) 320-03-32

Электронная почта: ocean@oceanchips.ru

Web: <http://oceanchips.ru/>

Адрес: 198099, г. Санкт-Петербург, ул. Калинина, д. 2, корп. 4, лит. А