

CKT. SIZE	DIM. A	DIM. B
4	2.00	4.00
6	4.00	6.00
8	6.00	8.00
10	8.00	10.00
12	10.00	12.00
14	12.00	14.00
16	14.00	16.00
18	16.00	18.00
20	18.00	20.00
22	20.00	22.00
24	22.00	24.00
26	24.00	26.00
28	26.00	28.00
30	28.00	30.00
32	30.00	32.00
34	32.00	34.00
36	34.00	36.00
38	36.00	38.00
40	38.00	40.00
42	40.00	42.00
44	42.00	44.00

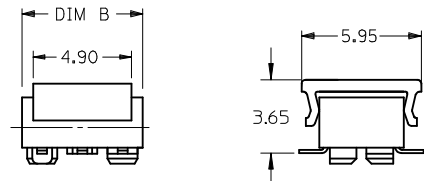

PARTS TO BE PACK WITH CAP (12 CKT SHOWN)

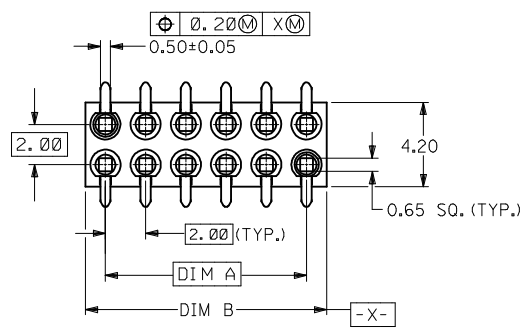
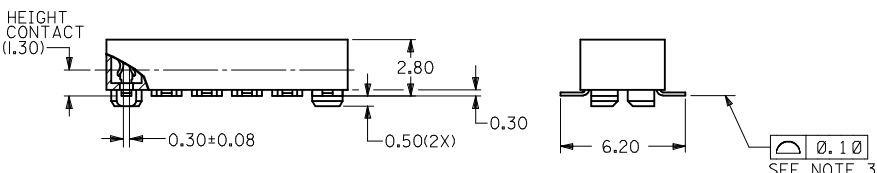
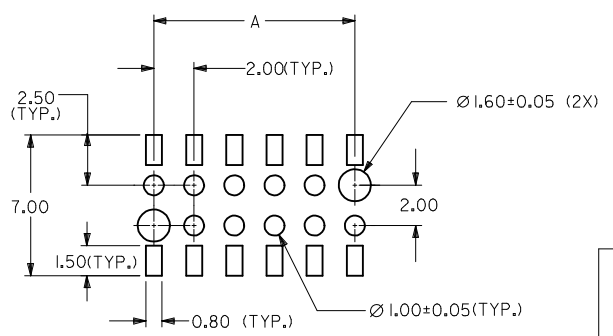

RECOMMENDED SOLDER PAD DESIGN

**PART NO. LEGEND**

87263 - \* \* \* \*

CIRCUIT SIZE

PLATING OPTION  
 3 - 0.38um MIN. GOLD  
 5 - 0.76um MIN. GOLD  
 6 - (0.13-0.38)um GOLD FLASH

PACKAGING  
 0 - W/CAP IN TUBE (SEE SHEET 2)  
 2 - W/O CAP IN TUBE (SEE SHEET 2)  
 8 - W/O CAP IN TAPE & REEL (SEE SHEET 3)  
 9 - W/CAP IN TAPE & REEL (SEE SHEET 3)

**NOTES:**

- FOR ILLUSTRATION PURPOSES, DRAWING SHOWS PART WITH 12 CIRCUIT SIZE.
- PLATING  
 POST-PLATING - SELECTIVE GOLD (SEE LEGEND) AT CONTACT AREA, AND 1.27um MIN. SELECTIVE TIN AT SOLDER AREA BOTH OVER 1.27um MIN. NICKEL OVERALL.
- CO-PLANARITY OF P.C TAIL TO BE MEASURED BY RESTING THE PART ON A FLAT GAGE SURFACE.
- PRODUCT SPECIFICATION PS-87263 APPLIES.
- CAP : HIGH TEMPERATURE THERMOPLASTIC, UL RATED 94V-0, SUITABLE FOR SURFACE-MOUNT SOLDERING PROCESS. COLOR BLACK
- POSITION OF CAP TO BE CENTRAL WITH RESPECT TO DIMENSION "A"
- CONTACT FACTORY FOR DETAILS ON THIS PART NO.
- PARTS SHALL BE PACKED IN MOISTURE BARRIER BAG.
- P/N: 87263-3686 TO BE PACKED IN EMBOSSED TAPE TYPE B1.

SEE SHEET 3 EC NO: S2015-0829 DRWN: CGOH CHKD: ATSEE APPR: KHL IM 2015/04/16 2015/04/17 2015/04/17	QUALITY SYMBOLS F <sub>A</sub> =0 F <sub>G</sub> =0 F <sub>P</sub> =0	GENERAL TOLERANCES (UNLESS SPECIFIED)		DIMENSION STYLE MM ONLY		SCALE NTS	DESIGN UNITS METRIC	THIRD ANGLE PROJECTION			
			mm	INCH	DRAWN BY JDK	DATE 1991/01/11	TITLE MGRID, B/ENTRY RECEPT. 2.80MM HT. W/LOC. PEGS W/CAP, SMT				
		4 PLACES ± --- ± ---	3 PLACES ± --- ± ---	2 PLACES ± 0.20 ± ---	1 PLACE ± --- ± ---	0 PLACE ± ±	CHECKED BY MLA I	DATE 1991/01/11	<b>molex</b> DOCUMENT NO. SD-87263-**2* SHEET NO. 1 OF 4		
		ANGULAR ± 3 °					APPROVED BY MLONG	DATE 2010/03/19			
DRAFT WHERE APPLICABLE MUST REMAIN WITHIN DIMENSIONS					MATERIAL NO. SEE TABLE		THIS DRAWING CONTAINS INFORMATION THAT IS PROPRIETARY TO MOLEX INCORPORATED AND SHOULD NOT BE USED WITHOUT WRITTEN PERMISSION				

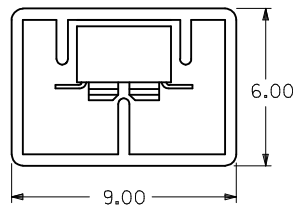
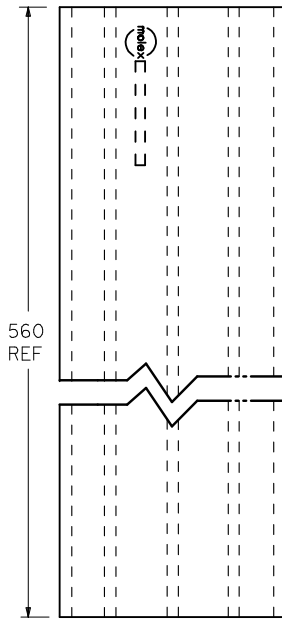

P/N 87263-\*\*\*2\*

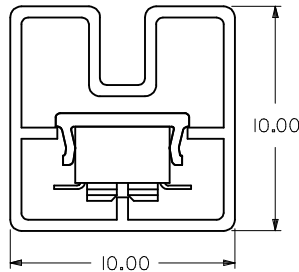
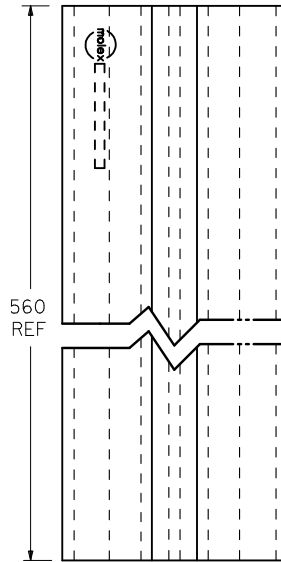

P/N 87263-\*\*\*0\*

CKT. SIZE	PART NO. FOR PARTS WITHOUT CAP	△ PART NO. FOR PARTS WITH CAP
4	87263-042*	87263-040*
6	87263-062*	87263-060*
8	87263-082*	87263-080*
10	87263-102*	87263-100*
12	87263-122*	87263-120*
14	87263-142*	87263-140*
16	87263-162*	87263-160*
18	87263-182*	87263-180*
20	87263-202*	87263-200*
22	87263-222*	87263-220*
24	87263-242*	87263-240*
26	87263-262*	87263-260*
28	87263-282*	87263-280*
30	87263-302*	87263-300*
32	87263-322*	87263-320*
34	87263-342*	87263-340*
36	87263-362*	87263-360*
38	87263-382*	87263-380*
40	87263-402*	87263-400*
42	87263-422*	87263-420*
44	△ 87263-442*	87263-440*

SEE SHEET 3 IEC NO: S2015-0829 DRWNG:CGOH 2015/04/16 CH'KD:ATSEE 2015/04/27 APPR:KHLIM 2015/04/27	QUALITY SYMBOLS	GENERAL TOLERANCES (UNLESS SPECIFIED)		DIMENSION STYLE	SCALE	DESIGN UNITS	THIRD ANGLE PROJECTION
	$F_A=0$ $F_B=0$ $F_C=0$	mm	INCH	MM ONLY	NTS	METRIC	
		4 PLACES ± --- ± ---	3 PLACES ± --- ± ---	DRAWN BY	DATE	TITLE	
		2 PLACES ± 0.20 ± ---	1 PLACE ± --- ± ---	JDK	1991/01/11	MGRID, B/ENTRY RECEPT. 2.80MM HT. W/LOC. PEGS W/CAP, SMT	
	0 PLACE ± ±	ANGULAR ± 3 °	MLAI	1991/01/11	<b>molex</b>		
	DRAFT WHERE APPLICABLE MUST REMAIN WITHIN DIMENSIONS	SEE TABLE	APPROVED BY	DATE	DOCUMENT NO.	SHEET NO.	
J10	REV	SIZE	THIS DRAWING CONTAINS INFORMATION THAT IS PROPRIETARY TO MOLEX INCORPORATED AND SHOULD NOT BE USED WITHOUT WRITTEN PERMISSION		SD-87263-***2*	2 OF 4	

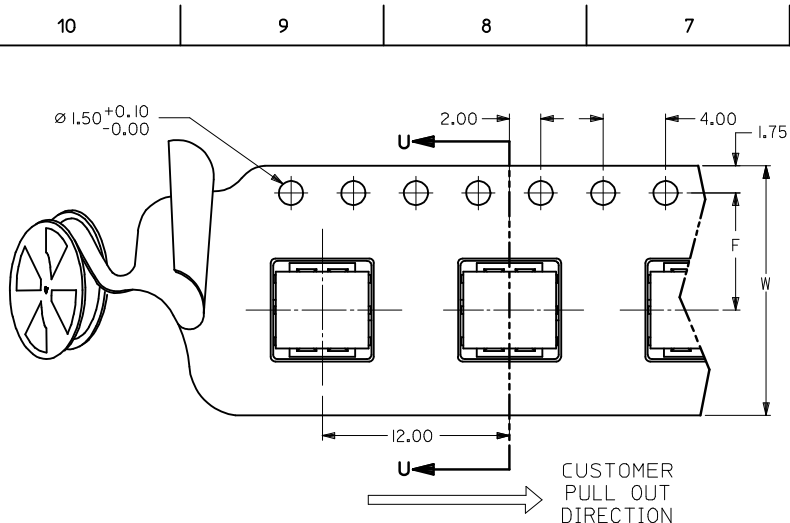

PART NO. 87263-\*\*\*9\* (CKTS 04 TO 14)  
SINGLE SPROCKET HOLE T/REEL - TYPE A

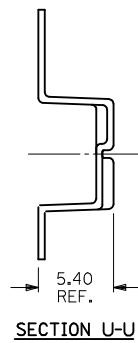

△ PART NO. FOR PARTS WITHOUT CAP IN T/REEL	△ PART NO. FOR PARTS WITH CAP IN T/REEL	CKT. SIZE	F	So	W	T/REEL TYPE
87263-048*	87263-049*	4	11.5	-	24	A
87263-068*	87263-069*	6	11.5	-	24	
87263-088*	87263-089*	8	11.5	-	24	
87263-108*	87263-109*	10	11.5	-	24	
87263-128*	87263-129*	12	11.5	-	24	
87263-148*	87263-149*	14	11.5	-	24	
87263-168*	87263-169*	16	11.5	-	24	
87263-188*	87263-189*	18	14.2	28.4	32	
87263-208*	87263-209*	20	20.2	40.4	44	
87263-228*	87263-229*	22	20.2	40.4	44	
87263-248*	87263-249*	24	20.2	40.4	44	
87263-268*	87263-269*	26	20.2	40.4	44	
87263-288*	87263-289*	28	20.2	40.4	44	
87263-308*	87263-309*	30	20.2	40.4	44	
87263-328*	87263-329*	32	26.2	52.4	56	
87263-348*	87263-349*	34	-	-	-	
△ 87263-368*	87263-369*	36	26.2	52.4	56	
87263-388*	87263-389*	38	-	-	-	
87263-408*	87263-409*	40	-	-	-	
△ 87263-3686	-	36	26.2	52.4	56	B1

NOTES:

- LEADER AND TRAILER TAPE
- PEELING OFF FORCE OF THE TOP TAPE: 20-80gf.  
(PEELING DIRECTION AS SHOWN IN FOLLOWING FIGURE)
- PACKAGING STANDARD IS AS PER EIA-481.
- TAPE & REEL QUANTITY: EMBOSSED TYPE A & B = 1000PCS/REEL  
EMBOSSED TYPE B1 = 900PCS/REEL
- THE TAPE IS TREATED FOR ANTI-STATIC.

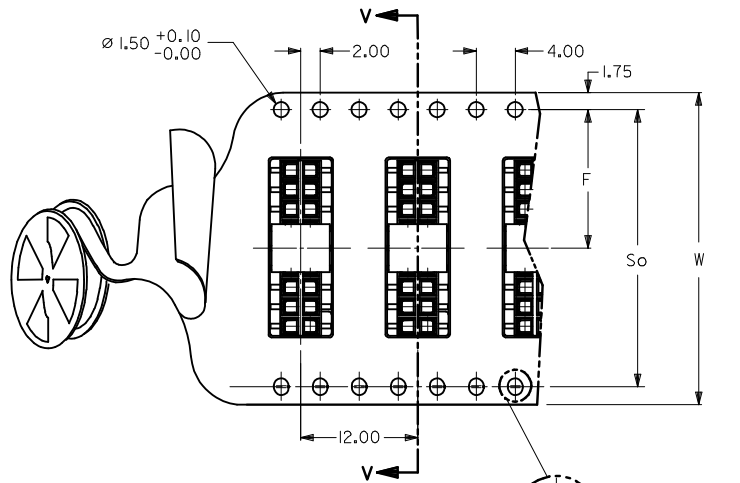

PART NO. 87263-\*\*\*9\* (CKTS 16 TO 40)  
DOUBLE SPROCKET HOLE T/REEL - TYPE B

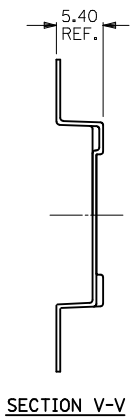

REVISE 87263-229* EC NO: S2015-0829 DRWN:CGOH 2015/04/16 CHKD:ATSEE 2015/04/17 APPR:KHLIM 2015/04/17	QUALITY SYMBOLS	GENERAL TOLERANCES (UNLESS SPECIFIED)	DIMENSION STYLE	SCALE	DESIGN UNITS	THIRD ANGLE PROJECTION																		
	$\nabla_A=0$ $\nabla_G=0$ $\nabla_P=0$	<table border="1"> <thead> <tr><th></th><th>mm</th><th>INCH</th></tr> </thead> <tbody> <tr><td>4 PLACES</td><td>± ---</td><td>± ---</td></tr> <tr><td>3 PLACES</td><td>± ---</td><td>± ---</td></tr> <tr><td>2 PLACES</td><td>± 0.20</td><td>± ---</td></tr> <tr><td>1 PLACE</td><td>± ---</td><td>± ---</td></tr> <tr><td>0 PLACE</td><td>±</td><td>±</td></tr> </tbody> </table>		mm	INCH	4 PLACES	± ---	± ---	3 PLACES	± ---	± ---	2 PLACES	± 0.20	± ---	1 PLACE	± ---	± ---	0 PLACE	±	±	MM ONLY	NTS	METRIC	
		mm	INCH																					
	4 PLACES	± ---	± ---																					
3 PLACES	± ---	± ---																						
2 PLACES	± 0.20	± ---																						
1 PLACE	± ---	± ---																						
0 PLACE	±	±																						
DESCRIPTION	ANGULAR ± 3 °	DRAWN BY	DATE	TITLE																				
REV	DRAFT WHERE APPLICABLE MUST REMAIN WITHIN DIMENSIONS	J10	JDK 1991/01/11	MGRID, B/ENTRY RECEPT. 2.80MM HT. W/LOC. PEGS W/CAP, SMT																				
			CHECKED BY	DATE																				
			MLAI 1991/01/11																					
			APPROVED BY	DATE																				
			MLONG 2010/03/19																					
			MATERIAL NO.	DOCUMENT NO.																				
			SEE TABLE	SD-87263-***2*																				
			SIZE A3																					
			THIS DRAWING CONTAINS INFORMATION THAT IS PROPRIETARY TO MOLEX INCORPORATED AND SHOULD NOT BE USED WITHOUT WRITTEN PERMISSION																					

T/REEL TYPE B1

PART WITHOUT CAP IN T&R	CKT SIZE	Bo	Ko	Ao
9 87263-3686	36	36.40	5.00	6.60

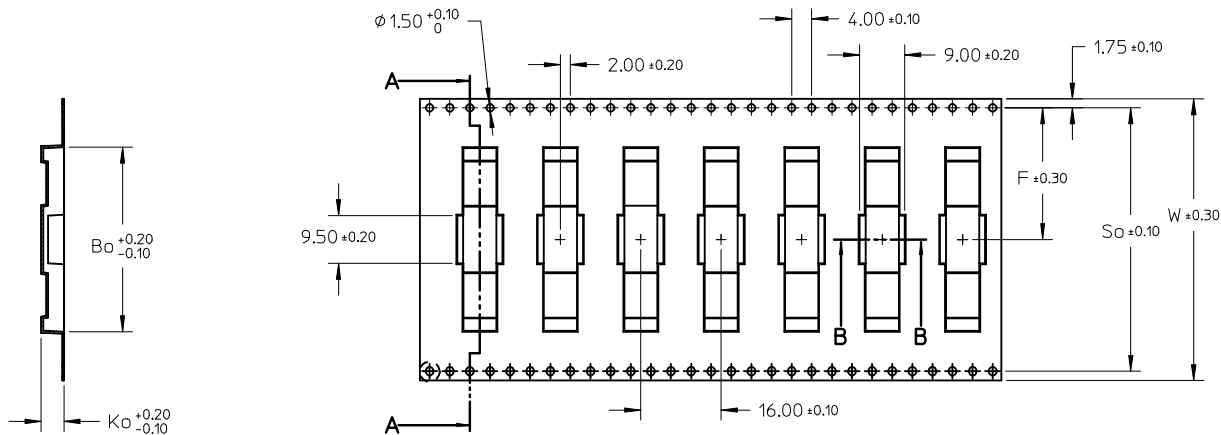

SECTION A-A

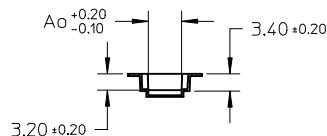

SECTION B-B

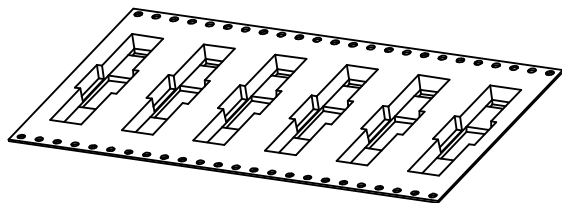

SEE SHEET 3 EC NO: S2015-0829 DRWING: G0H CHKD: AISEE APPR: KHLIM 2015/04/16 2015/04/17 2015/04/17	QUALITY SYMBOLS	GENERAL TOLERANCES (UNLESS SPECIFIED)		DIMENSION STYLE MM ONLY		SCALE NTS	DESIGN UNITS METRIC	THIRD ANGLE PROJECTION	
	$\nabla_A = 0$ $\nabla_C = 0$ $\nabla_P = 0$	4 PLACES ± --- ± --- 3 PLACES ± --- ± --- 2 PLACES ± 0.20 ± --- 1 PLACE ± --- ± --- 0 PLACE ± ±	mm	INCH	DRAWN BY JDK	DATE 1991/01/11	TITLE	MGRID, B/ENTRY RECEPT. 2.80MM HT. W/LOC. PEGS W/CAP, SMT	
	DESCRIPTION	DRAFT WHERE APPLICABLE MUST REMAIN WITHIN DIMENSIONS		MATERIAL NO. MLONG		DATE 2010/03/19	DOCUMENT NO. SD-87263-**2*		
	REV J10	ANGULAR ± 3 °		SEE TABLE		SHEET NO. 4 OF 4			

Компания «Океан Электроники» предлагает заключение долгосрочных отношений при поставках импортных электронных компонентов на взаимовыгодных условиях!

Наши преимущества:

- Поставка оригинальных импортных электронных компонентов напрямую с производств Америки, Европы и Азии, а так же с крупнейших складов мира;
- Широкая линейка поставок активных и пассивных импортных электронных компонентов (более 30 млн. наименований);
- Поставка сложных, дефицитных, либо снятых с производства позиций;
- Оперативные сроки поставки под заказ (от 5 рабочих дней);
- Экспресс доставка в любую точку России;
- Помощь Конструкторского Отдела и консультации квалифицированных инженеров;
- Техническая поддержка проекта, помощь в подборе аналогов, поставка прототипов;
- Поставка электронных компонентов под контролем ВП;
- Система менеджмента качества сертифицирована по Международному стандарту ISO 9001;
- При необходимости вся продукция военного и аэрокосмического назначения проходит испытания и сертификацию в лаборатории (по согласованию с заказчиком);
- Поставка специализированных компонентов военного и аэрокосмического уровня качества (Xilinx, Altera, Analog Devices, Intersil, Interpoint, Microsemi, Actel, Aeroflex, Peregrine, VPT, Syfer, Eurofarad, Texas Instruments, MS Kennedy, Miteq, Cobham, E2V, MA-COM, Hittite, Mini-Circuits, General Dynamics и др.);

Компания «Океан Электроники» является официальным дистрибьютором и эксклюзивным представителем в России одного из крупнейших производителей разъемов военного и аэрокосмического назначения «**JONHON**», а так же официальным дистрибьютором и эксклюзивным представителем в России производителя высокотехнологичных и надежных решений для передачи СВЧ сигналов «**FORSTAR**».



## JONHON

«**JONHON**» (основан в 1970 г.)

Разъемы специального, военного и аэрокосмического назначения:

(Применяются в военной, авиационной, аэрокосмической, морской, железнодорожной, горно- и нефтедобывающей отраслях промышленности)

«**FORSTAR**» (основан в 1998 г.)

ВЧ соединители, коаксиальные кабели,  
кабельные сборки и микроволновые компоненты:

(Применяются в телекоммуникациях гражданского и специального назначения, в средствах связи, РЛС, а так же военной, авиационной и аэрокосмической отраслях промышленности).



Телефон: 8 (812) 309-75-97 (многоканальный)

Факс: 8 (812) 320-03-32

Электронная почта: [ocean@oceanchips.ru](mailto:ocean@oceanchips.ru)

Web: <http://oceanchips.ru/>

Адрес: 198099, г. Санкт-Петербург, ул. Калинина, д. 2, корп. 4, лит. А