

CKT. SIZE	DIM. A	DIM. B
4	2.00	4.00
6	4.00	6.00
8	6.00	8.00
10	8.00	10.00
12	10.00	12.00
14	12.00	14.00
16	14.00	16.00
18	16.00	18.00
20	18.00	20.00
22	20.00	22.00
24	22.00	24.00
26	24.00	26.00
28	26.00	28.00
30	28.00	30.00
32	30.00	32.00
34	32.00	34.00
36	34.00	36.00
38	36.00	38.00
40	38.00	40.00
42	40.00	42.00
44	42.00	44.00

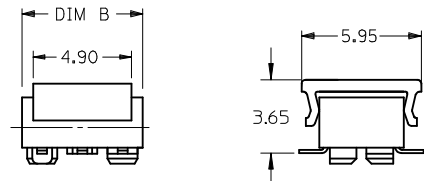

PARTS TO BE PACK WITH CAP (12 CKT SHOWN)

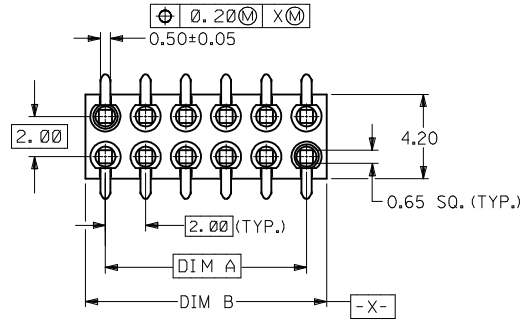
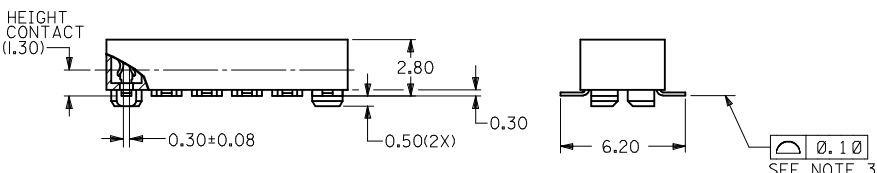
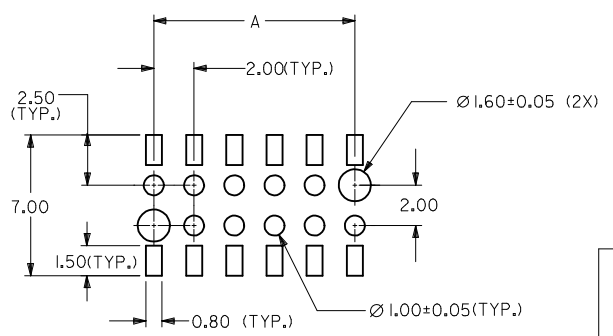

RECOMMENDED SOLDER PAD DESIGN

PART NO. LEGEND

87263 - * * * *

CIRCUIT SIZE

PLATING OPTION
 3 - 0.38um MIN. GOLD
 5 - 0.76um MIN. GOLD
 6 - (0.13-0.38)um GOLD FLASH

PACKAGING
 0 - W/CAP IN TUBE (SEE SHEET 2)
 2 - W/O CAP IN TUBE (SEE SHEET 2)
 8 - W/O CAP IN TAPE & REEL (SEE SHEET 3)
 9 - W/CAP IN TAPE & REEL (SEE SHEET 3)

NOTES:

- FOR ILLUSTRATION PURPOSES, DRAWING SHOWS PART WITH 12 CIRCUIT SIZE.
- PLATING
 POST-PLATING - SELECTIVE GOLD (SEE LEGEND) AT CONTACT AREA, AND 1.27um MIN. SELECTIVE TIN AT SOLDER AREA BOTH OVER 1.27um MIN. NICKEL OVERALL.
- CO-PLANARITY OF P.C TAIL TO BE MEASURED BY RESTING THE PART ON A FLAT GAGE SURFACE.
- PRODUCT SPECIFICATION PS-87263 APPLIES.
- CAP : HIGH TEMPERATURE THERMOPLASTIC, UL RATED 94V-0, SUITABLE FOR SURFACE-MOUNT SOLDERING PROCESS. COLOR BLACK
- POSITION OF CAP TO BE CENTRAL WITH RESPECT TO DIMENSION "A"
- CONTACT FACTORY FOR DETAILS ON THIS PART NO.
- PARTS SHALL BE PACKED IN MOISTURE BARRIER BAG.
- P/N: 87263-3686 TO BE PACKED IN EMBOSSED TAPE TYPE B1.

SEE SHEET 3 EC NO: S2015-0829 DRWN: CGOH CHKD: ATSEE APPR: KHL IM 2015/04/16 2015/04/17 2015/04/17	REV DESCRIPTION	QUALITY SYMBOLS		GENERAL TOLERANCES (UNLESS SPECIFIED)		DIMENSION STYLE		SCALE	DESIGN UNITS	THIRD ANGLE PROJECTION			
						MM ONLY		NTS	METRIC				
						mm	INCH	DRAWN BY		DATE		TITLE	
								JDK		1991/01/11		MGRID, B/ENTRY RECEPT. 2.80MM HT. W/LOC. PEGS W/CAP, SMT	
						CHECKED BY		DATE		molex			
						MLA I		1991/01/11					
						APPROVED BY		DATE		DOCUMENT NO. SD-87263-**2* SHEET NO. 1 OF 4			
						MLONG		2010/03/19					
				ANGULAR ± 3 °		MATERIAL NO.		SEE TABLE					
				DRAFT WHERE APPLICABLE MUST REMAIN WITHIN DIMENSIONS		SIZE		A3		THIS DRAWING CONTAINS INFORMATION THAT IS PROPRIETARY TO MOLEX INCORPORATED AND SHOULD NOT BE USED WITHOUT WRITTEN PERMISSION			

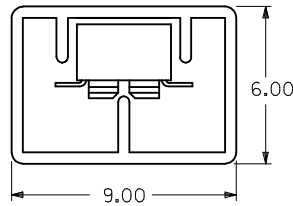
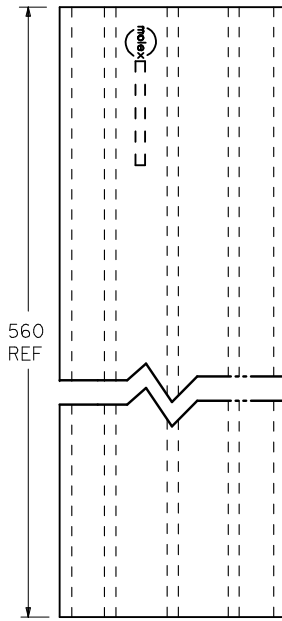

P/N 87263-***2*

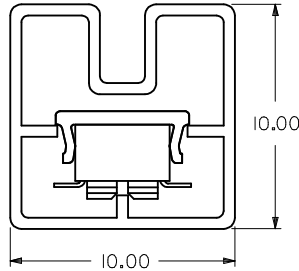
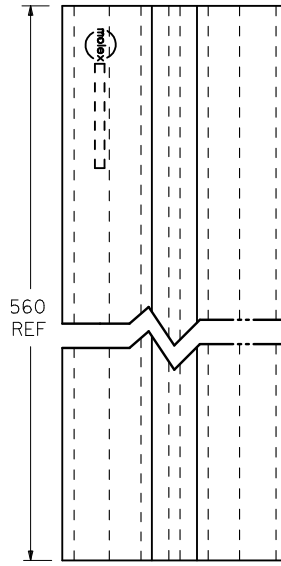

P/N 87263-***0*

CKT. SIZE	PART NO. FOR PARTS WITHOUT CAP	△ PART NO. FOR PARTS WITH CAP
4	87263-042*	87263-040*
6	87263-062*	87263-060*
8	87263-082*	87263-080*
10	87263-102*	87263-100*
12	87263-122*	87263-120*
14	87263-142*	87263-140*
16	87263-162*	87263-160*
18	87263-182*	87263-180*
20	87263-202*	87263-200*
22	87263-222*	87263-220*
24	87263-242*	87263-240*
26	87263-262*	87263-260*
28	87263-282*	87263-280*
30	87263-302*	87263-300*
32	87263-322*	87263-320*
34	87263-342*	87263-340*
36	87263-362*	87263-360*
38	87263-382*	87263-380*
40	87263-402*	87263-400*
42	87263-422*	87263-420*
44	△ 87263-442*	87263-440*

SEE SHEET 3 IEC NO: S2015-0829 DRWNG:CGOH 2015/04/16 CH'KD:ATSEE 2015/04/27 APPR:KHLIM 2015/04/27	QUALITY SYMBOLS	GENERAL TOLERANCES (UNLESS SPECIFIED)		DIMENSION STYLE	SCALE	DESIGN UNITS	THIRD ANGLE PROJECTION																																						
	$F_{\text{A}}=0$ $F_{\text{B}}=0$ $F_{\text{C}}=0$	<table border="1"> <tr><th></th><th>mm</th><th>INCH</th></tr> <tr><td>4 PLACES</td><td>± ---</td><td>± ---</td></tr> <tr><td>3 PLACES</td><td>± ---</td><td>± ---</td></tr> <tr><td>2 PLACES</td><td>± 0.20</td><td>± ---</td></tr> <tr><td>1 PLACE</td><td>± ---</td><td>± ---</td></tr> <tr><td>0 PLACE</td><td>±</td><td>±</td></tr> </table>		mm	INCH	4 PLACES	± ---	± ---	3 PLACES	± ---	± ---	2 PLACES	± 0.20	± ---	1 PLACE	± ---	± ---	0 PLACE	±	±	MM ONLY	NTS	METRIC																						
		mm	INCH																																										
	4 PLACES	± ---	± ---																																										
3 PLACES	± ---	± ---																																											
2 PLACES	± 0.20	± ---																																											
1 PLACE	± ---	± ---																																											
0 PLACE	±	±																																											
REV	DESCRIPTION	<table border="1"> <tr><td>J10</td><td></td></tr> </table>	J10		<table border="1"> <tr><td>4 PLACES</td><td>± ---</td><td>± ---</td></tr> <tr><td>3 PLACES</td><td>± ---</td><td>± ---</td></tr> <tr><td>2 PLACES</td><td>± 0.20</td><td>± ---</td></tr> <tr><td>1 PLACE</td><td>± ---</td><td>± ---</td></tr> <tr><td>0 PLACE</td><td>±</td><td>±</td></tr> </table>	4 PLACES	± ---	± ---	3 PLACES	± ---	± ---	2 PLACES	± 0.20	± ---	1 PLACE	± ---	± ---	0 PLACE	±	±	<table border="1"> <tr><th>DRAWN BY</th><th>DATE</th></tr> <tr><td>JDK</td><td>1991/01/11</td></tr> <tr><th>CHECKED BY</th><th>DATE</th></tr> <tr><td>MLAI</td><td>1991/01/11</td></tr> <tr><th>APPROVED BY</th><th>DATE</th></tr> <tr><td>MLONG</td><td>2010/03/19</td></tr> </table>	DRAWN BY	DATE	JDK	1991/01/11	CHECKED BY	DATE	MLAI	1991/01/11	APPROVED BY	DATE	MLONG	2010/03/19	<table border="1"> <tr><th>TITLE</th></tr> <tr><td>MGRID, B/ENTRY RECEPT. 2.80MM HT. W/LOC. PEGS W/CAP, SMT</td></tr> </table>	TITLE	MGRID, B/ENTRY RECEPT. 2.80MM HT. W/LOC. PEGS W/CAP, SMT	<table border="1"> <tr><th>MATERIAL NO.</th></tr> <tr><td>SEE TABLE</td></tr> </table>	MATERIAL NO.	SEE TABLE	<table border="1"> <tr><th>DOCUMENT NO.</th></tr> <tr><td>SD-87263-***2*</td></tr> </table>	DOCUMENT NO.	SD-87263-***2*	<table border="1"> <tr><th>SHEET NO.</th></tr> <tr><td>2 OF 4</td></tr> </table>	SHEET NO.	2 OF 4
J10																																													
4 PLACES	± ---	± ---																																											
3 PLACES	± ---	± ---																																											
2 PLACES	± 0.20	± ---																																											
1 PLACE	± ---	± ---																																											
0 PLACE	±	±																																											
DRAWN BY	DATE																																												
JDK	1991/01/11																																												
CHECKED BY	DATE																																												
MLAI	1991/01/11																																												
APPROVED BY	DATE																																												
MLONG	2010/03/19																																												
TITLE																																													
MGRID, B/ENTRY RECEPT. 2.80MM HT. W/LOC. PEGS W/CAP, SMT																																													
MATERIAL NO.																																													
SEE TABLE																																													
DOCUMENT NO.																																													
SD-87263-***2*																																													
SHEET NO.																																													
2 OF 4																																													
		ANGULAR ± 3 °		THIS DRAWING CONTAINS INFORMATION THAT IS PROPRIETARY TO MOLEX INCORPORATED AND SHOULD NOT BE USED WITHOUT WRITTEN PERMISSION																																									
		DRAFT WHERE APPLICABLE MUST REMAIN WITHIN DIMENSIONS		SIZE A3																																									

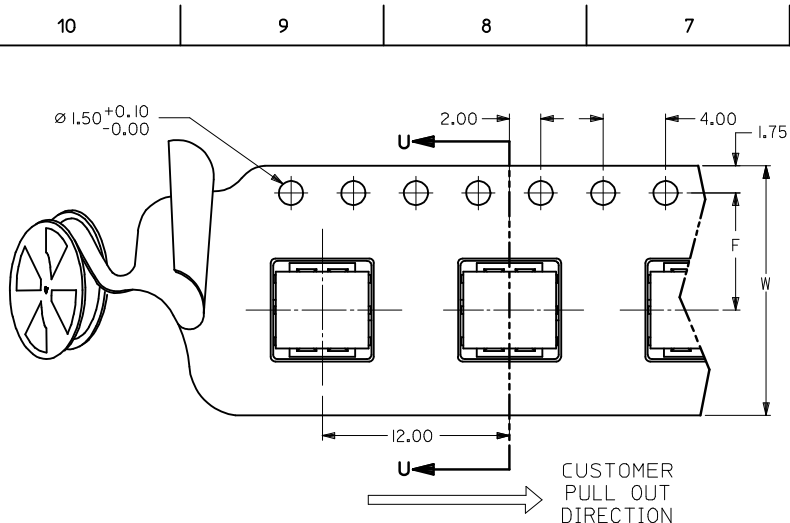

PART NO. 87263-***9* (CKTS 04 TO 14)
SINGLE SPROCKET HOLE T/REEL - TYPE A

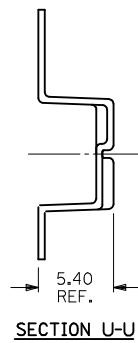

△ PART NO. FOR PARTS WITHOUT CAP IN T/REEL	△ PART NO. FOR PARTS WITH CAP IN T/REEL	CKT. SIZE	F	So	W	T/REEL TYPE
87263-048*	87263-049*	4	11.5	-	24	A
87263-068*	87263-069*	6	11.5	-	24	
87263-088*	87263-089*	8	11.5	-	24	
87263-108*	87263-109*	10	11.5	-	24	
87263-128*	87263-129*	12	11.5	-	24	
87263-148*	87263-149*	14	11.5	-	24	
87263-168*	87263-169*	16	11.5	-	24	
87263-188*	87263-189*	18	14.2	28.4	32	
87263-208*	87263-209*	20	20.2	40.4	44	
87263-228*	87263-229*	22	20.2	40.4	44	
87263-248*	87263-249*	24	20.2	40.4	44	
87263-268*	87263-269*	26	20.2	40.4	44	
87263-288*	87263-289*	28	20.2	40.4	44	
87263-308*	87263-309*	30	20.2	40.4	44	
87263-328*	87263-329*	32	26.2	52.4	56	
87263-348*	87263-349*	34	-	-	-	
△ 87263-368*	87263-369*	36	26.2	52.4	56	
87263-388*	87263-389*	38	-	-	-	
87263-408*	87263-409*	40	-	-	-	
△ 87263-3686	-	36	26.2	52.4	56	B1

NOTES:

- LEADER AND TRAILER TAPE
- PEELING OFF FORCE OF THE TOP TAPE: 20-80gf.
 (PEELING DIRECTION AS SHOWN IN FOLLOWING FIGURE)
- PACKAGING STANDARD IS AS PER EIA-481.
- TAPE & REEL QUANTITY: EMBOSSED TYPE A & B = 1000PCS/REEL
 EMBOSSED TYPE B1 = 900PCS/REEL
- THE TAPE IS TREATED FOR ANTI-STATIC.

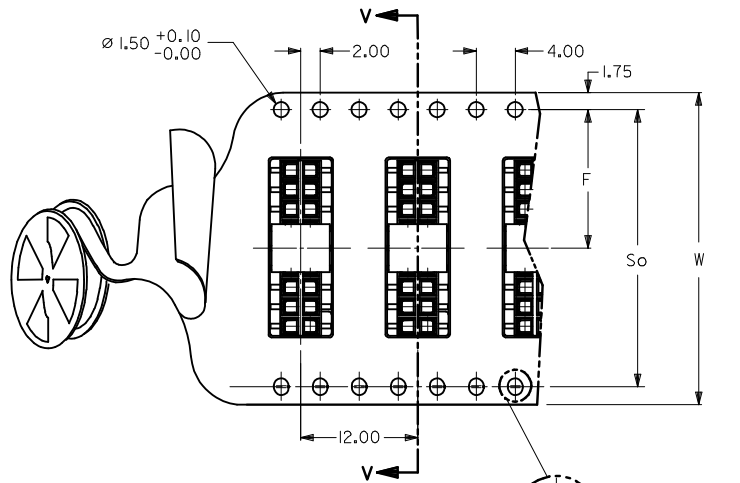

PART NO. 87263-***9* (CKTS 16 TO 40)
DOUBLE SPROCKET HOLE T/REEL - TYPE B

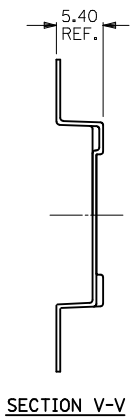

REVISE 87263-229* EC NO: S2015-0829 DRWN:CGOH 2015/04/16 CHKD:ATSEE 2015/04/27 APPR:KHLIM 2015/04/27	QUALITY SYMBOLS	GENERAL TOLERANCES (UNLESS SPECIFIED)		DIMENSION STYLE MM ONLY		SCALE NTS	DESIGN UNITS METRIC	THIRD ANGLE PROJECTION
	$\nabla_A=0$	4 PLACES	mm	INCH	DRAWN BY JDK	DATE 1991/01/11	TITLE MGRID, B/ENTRY RECEPT. 2.80MM HT. W/LOC. PEGS W/CAP, SMT	
	$\nabla_G=0$	3 PLACES	± ---	± ---	CHECKED BY MLAI	DATE 1991/01/11	molex DOCUMENT NO. SD-87263-***2*	SHEET NO. 3 OF 4
	$\nabla_P=0$	2 PLACES	± 0.20	± ---	APPROVED BY MLONG	DATE 2010/03/19		
		1 PLACE	± ---	± ---	MATERIAL NO. SEE TABLE			
		0 PLACE	±	±	THIS DRAWING CONTAINS INFORMATION THAT IS PROPRIETARY TO MOLEX INCORPORATED AND SHOULD NOT BE USED WITHOUT WRITTEN PERMISSION			

T/REEL TYPE B1

PART WITHOUT CAP IN T&R	CKT SIZE	Bo	Ko	Ao
9 87263-3686	36	36.40	5.00	6.60

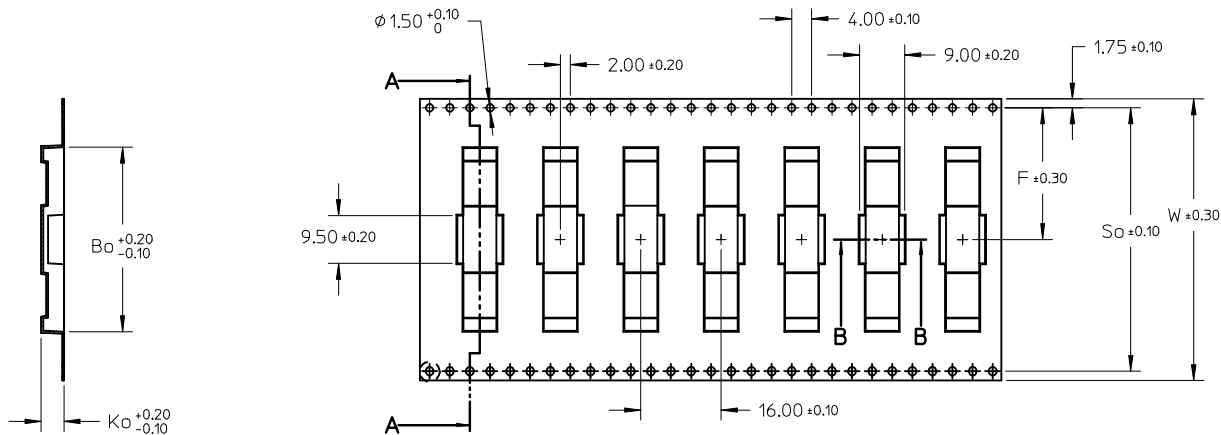

SECTION A-A

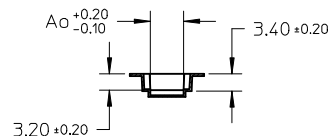

SECTION B-B

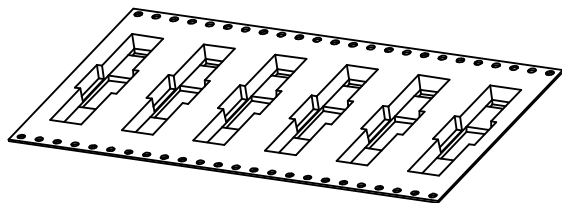

SEE SHEET 3 EC NO: S2015-0829 DRWING: G0H CHKD: AISEE APPR: KHLIM 2015/04/16 2015/04/17 2015/04/17	QUALITY SYMBOLS	GENERAL TOLERANCES (UNLESS SPECIFIED)		DIMENSION STYLE		SCALE	DESIGN UNITS	THIRD ANGLE PROJECTION		
	$\nabla_A = 0$ $\nabla_C = 0$ $\nabla_P = 0$	4 PLACES ± --- ± --- 3 PLACES ± --- ± --- 2 PLACES ± 0.20 ± --- 1 PLACE ± --- ± --- 0 PLACE ± ±	mm	INCH	MM ONLY		NTS	METRIC		
	DESCRIPTION	DRAFT WHERE APPLICABLE MUST REMAIN WITHIN DIMENSIONS		DRAWN BY	DATE	TITLE				
	REV	ANGULAR ± 3 °		JDK	1991/01/11	MGRID, B/ENTRY RECEPT. 2.80MM HT. W/LOC. PEGS W/CAP, SMT				
J10	MATERIAL NO.		MLAI	1991/01/11	molex DOCUMENT NO. SD-87263-**2* SHEET NO. 4 OF 4					
	SIZE		MLONG	2010/03/19						
	SEE TABLE		THIS DRAWING CONTAINS INFORMATION THAT IS PROPRIETARY TO MOLEX INCORPORATED AND SHOULD NOT BE USED WITHOUT WRITTEN PERMISSION							

Компания «Океан Электроники» предлагает заключение долгосрочных отношений при поставках импортных электронных компонентов на взаимовыгодных условиях!

Наши преимущества:

- Поставка оригинальных импортных электронных компонентов напрямую с производств Америки, Европы и Азии, а так же с крупнейших складов мира;
- Широкая линейка поставок активных и пассивных импортных электронных компонентов (более 30 млн. наименований);
- Поставка сложных, дефицитных, либо снятых с производства позиций;
- Оперативные сроки поставки под заказ (от 5 рабочих дней);
- Экспресс доставка в любую точку России;
- Помощь Конструкторского Отдела и консультации квалифицированных инженеров;
- Техническая поддержка проекта, помощь в подборе аналогов, поставка прототипов;
- Поставка электронных компонентов под контролем ВП;
- Система менеджмента качества сертифицирована по Международному стандарту ISO 9001;
- При необходимости вся продукция военного и аэрокосмического назначения проходит испытания и сертификацию в лаборатории (по согласованию с заказчиком);
- Поставка специализированных компонентов военного и аэрокосмического уровня качества (Xilinx, Altera, Analog Devices, Intersil, Interpoint, Microsemi, Actel, Aeroflex, Peregrine, VPT, Syfer, Eurofarad, Texas Instruments, MS Kennedy, Miteq, Cobham, E2V, MA-COM, Hittite, Mini-Circuits, General Dynamics и др.);

Компания «Океан Электроники» является официальным дистрибьютором и эксклюзивным представителем в России одного из крупнейших производителей разъемов военного и аэрокосмического назначения «**JONHON**», а так же официальным дистрибьютором и эксклюзивным представителем в России производителя высокотехнологичных и надежных решений для передачи СВЧ сигналов «**FORSTAR**».



JONHON

«**JONHON**» (основан в 1970 г.)

Разъемы специального, военного и аэрокосмического назначения:

(Применяются в военной, авиационной, аэрокосмической, морской, железнодорожной, горно- и нефтедобывающей отраслях промышленности)

«**FORSTAR**» (основан в 1998 г.)

ВЧ соединители, коаксиальные кабели, кабельные сборки и микроволновые компоненты:

(Применяются в телекоммуникациях гражданского и специального назначения, в средствах связи, РЛС, а так же военной, авиационной и аэрокосмической отраслях промышленности).



Телефон: 8 (812) 309-75-97 (многоканальный)

Факс: 8 (812) 320-03-32

Электронная почта: ocean@oceanchips.ru

Web: <http://oceanchips.ru/>

Адрес: 198099, г. Санкт-Петербург, ул. Калинина, д. 2, корп. 4, лит. А