

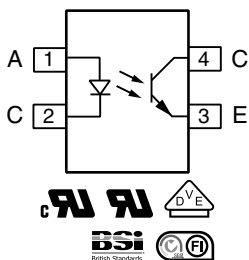

Optocoupler, Phototransistor Output, High Reliability, 5300 V_{RMS}

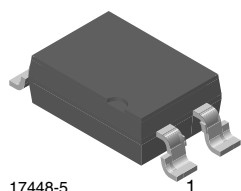

FEATURES

- Excellent CTR linearity depending on forward current
- Isolation test voltage, 5300 V_{RMS}
- Fast switching times
- Low CTR degradation
- Low coupling capacitance
- Material categorization: For definitions of compliance please see www.vishay.com/doc?99912



RoHS COMPLIANT

DESCRIPTION

The SFH6156 features a variety of transfer ratios, low coupling capacitance and high isolation voltage. This coupler has a GaAs infrared diode emitter, which is optically coupled to a silicon planar phototransistor detector, and is incorporated in a plastic SMD package.

The coupling devices are designed for signal transmission between two electrically separated circuits.

APPLICATIONS

- Switchmode power supply
- Telecom
- Battery powered equipment

AGENCY APPROVALS

- UL1577, file no. E52744 system code H or J, double protection
- DIN EN 60747-5-5 (VDE 0884-5) available with option 1
- cUL tested to CSA 22.2 bulletin 5A
- BSI IEC 60950, IEC 60065
- FIMKO EN6005, EN60950-1

ORDERING INFORMATION				
S	F	H	6	1
6	5	6	-	#
X	0	0	1	T
PART NUMBER			CTR BIN	PACKAGE OPTION
			TAPE AND REEL	SMD-4
AGENCY CERTIFIED/PACKAGE	CTR (%)			
	10 mA			
UL, cUL, BSI, FIMKO	40 to 80	63 to 125	100 to 200	160 to 320
SMD-4, 100 mil, pitch	SFH6156-1	SFH6156-2	SFH6156-3	SFH6156-4
	SFH6156-1T	SFH6156-2T	SFH6156-3T	SFH6156-4T
VDE, UL, cUL, BSI, FIMKO	40 to 80	63 to 125	100 to 200	160 to 320
SMD-4, 100 mil, pitch	SFH6156-1X001	SFH6156-2X001	SFH6156-3X001	SFH6156-4X001
	SFH6156-1X001T	SFH6156-2X001T	SFH6156-3X001T	SFH6156-4X001T



ABSOLUTE MAXIMUM RATINGS ($T_{amb} = 25\text{ }^{\circ}\text{C}$, unless otherwise specified)				
PARAMETER	TEST CONDITION	SYMBOL	VALUE	UNIT
INPUT				
Reverse voltage		V_R	6	V
DC forward current		I_F	60	mA
Surge forward current	$t_p \leq 10\text{ }\mu\text{s}$	I_{FSM}	2.5	A
OUTPUT				
Collector emitter voltage		V_{CEO}	70	V
Emitter collector voltage		V_{ECO}	7	V
Collector current		I_C	50	mA
	$t_p \leq 1\text{ ms}$	I_C	100	mA
COUPLER				
Isolation test voltage between emitter and detector	$t = 1\text{ s}$	V_{ISO}	5300	V_{RMS}
Creepage distance			≥ 7	mm
Clearance distance			≥ 7	mm
Insulation thickness between emitter and detector			≥ 0.4	mm
Comparative tracking index per DIN IEC112/VDE0303 part 1		CTI	≥ 175	
Isolation resistance	$V_{IO} = 500\text{ V}, T_{amb} = 25\text{ }^{\circ}\text{C}$	R_{IO}	$\geq 10^{12}$	Ω
	$V_{IO} = 500\text{ V}, T_{amb} = 100\text{ }^{\circ}\text{C}$	R_{IO}	$\geq 10^{11}$	Ω
Storage temperature range		T_{stg}	- 55 to + 150	$^{\circ}\text{C}$
Ambient temperature range		T_{amb}	- 55 to +100	$^{\circ}\text{C}$
Soldering temperature ⁽¹⁾	max. 10 s	T_{sld}	260	$^{\circ}\text{C}$

Notes

- Stresses in excess of the absolute maximum ratings can cause permanent damage to the device. Functional operation of the device is not implied at these or any other conditions in excess of those given in the operational sections of this document. Exposure to absolute maximum ratings for extended periods of the time can adversely affect reliability.
- ⁽¹⁾ Refer to reflow profile for soldering conditions for surface mounted devices (SMD).



Fig. 1 - Permissible Power Dissipation vs. Ambient Temperature



THERMAL CHARACTERISTICS			
PARAMETER	SYMBOL	VALUE	UNIT
LED power dissipation	P_{diss}	100	mW
Output power dissipation	P_{diss}	150	mW
Maximum LED junction temperature	$T_{jmax.}$	125	°C
Maximum output die junction temperature	$T_{jmax.}$	125	°C
Thermal resistance, junction emitter to board	θ_{EB}	173	°C/W
Thermal resistance, junction emitter to case	θ_{EC}	149	°C/W
Thermal resistance, junction detector to board	θ_{DB}	111	°C/W
Thermal resistance, junction detector to case	θ_{DC}	127	°C/W
Thermal resistance, junction emitter to junction detector	θ_{ED}	95	°C/W
Thermal resistance, board to ambient ⁽¹⁾	θ_{BA}	195	°C/W
Thermal resistance, case to ambient ⁽¹⁾	θ_{CA}	3573	°C/W

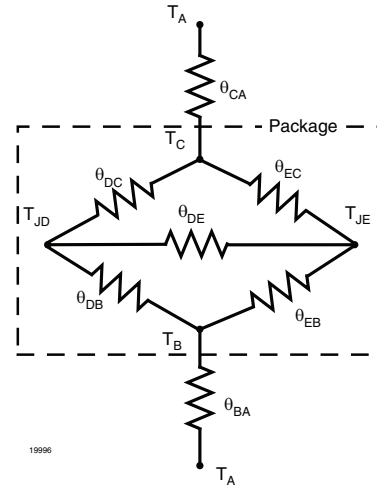

Notes

- The thermal model is represented in the thermal network below. Each resistance value given in this model can be used to calculate the temperatures at each node for a given operating condition. The thermal resistance from board to ambient will be dependent on the type of PCB, layout and thickness of copper traces. For a detailed explanation of the thermal model, please reference Vishay’s thermal characteristics of optocouplers application note.
- ⁽¹⁾ For 2 layer FR4 board (4" x 3" x 0.062")

ELECTRICAL CHARACTERISTICS ($T_{amb} = 25\text{ }^{\circ}\text{C}$, unless otherwise specified)							
PARAMETER	TEST CONDITION	PART	SYMBOL	MIN.	TYP.	MAX.	UNIT
INPUT							
Forward voltage	$I_F = 60\text{ mA}$		V_F		1.25	1.65	V
Reverse current	$V_R = 6\text{ V}$		I_R		0.01	10	μA
Capacitance	$V_R = 0\text{ V}, f = 1\text{ MHz}$		C_O		13		pF
OUTPUT							
Collector emitter capacitance	$V_{CE} = 5\text{ V}, f = 1\text{ MHz}$		C_{CE}		5.2		pF
Collector emitter leakage current	$V_{CE} = 10\text{ V}$	SFH6156-1	I_{CEO}		2	50	nA
		SFH6156-2	I_{CEO}		2	50	nA
		SFH6156-3	I_{CEO}		5	100	nA
		SFH6156-4	I_{CEO}		5	100	nA
COUPLER							
Collector emitter saturation voltage	$I_F = 10\text{ mA}, I_C = 2.5\text{ mA}$		V_{CEsat}		0.25	0.4	V
Coupling capacitance			C_C		0.4		pF

Note

- Minimum and maximum values are testing requirements. Typical values are characteristics of the device and are the result of engineering evaluation. Typical values are for information only and are not part of the testing requirements.

CURRENT TRANSFER RATIO							
PARAMETER	TEST CONDITION	PART	SYMBOL	MIN.	TYP.	MAX.	UNIT
I_C/I_F	$I_F = 10\text{ mA}, V_{CE} = 5\text{ V}$	SFH6156-1	CTR	40		80	%
		SFH6156-2	CTR	63		125	%
		SFH6156-3	CTR	100		200	%
		SFH6156-4	CTR	160		320	%
	$I_F = 1\text{ mA}, V_{CE} = 5\text{ V}$	SFH6156-1	CTR	13	30		%
		SFH6156-2	CTR	22	45		%
		SFH6156-3	CTR	34	70		%



SWITCHING CHARACTERISTICS							
PARAMETER	TEST CONDITION	PART	SYMBOL	MIN.	TYP.	MAX.	UNIT
NON-SATURATED							
Rise time	$I_F = 10 \text{ mA}$, $V_{CC} = 5 \text{ V}$, $T_A = 25 \text{ }^\circ\text{C}$, $R_L = 75 \text{ } \Omega$		t_r		2		μs
Fall time	$I_F = 10 \text{ mA}$, $V_{CC} = 5 \text{ V}$, $T_A = 25 \text{ }^\circ\text{C}$, $R_L = 75 \text{ } \Omega$		t_f		2		μs
Turn-on time	$I_F = 10 \text{ mA}$, $V_{CC} = 5 \text{ V}$, $T_A = 25 \text{ }^\circ\text{C}$, $R_L = 75 \text{ } \Omega$		t_{on}		3		μs
Turn-off time	$I_F = 10 \text{ mA}$, $V_{CC} = 5 \text{ V}$, $T_A = 25 \text{ }^\circ\text{C}$, $R_L = 75 \text{ } \Omega$		t_{off}		2.3		μs
Cut-off frequency	$I_F = 10 \text{ mA}$, $V_{CC} = 5 \text{ V}$, $T_A = 25 \text{ }^\circ\text{C}$, $R_L = 75 \text{ } \Omega$		f_{ctr}		250		kHz
SATURATED							
Rise time	$V_{CC} = 5 \text{ V}$, $T_A = 25 \text{ }^\circ\text{C}$, $R_L = 1 \text{ k}\Omega$, $I_F = 20 \text{ mA}$	SFH6156-1	t_r		2		μs
	$V_{CC} = 5 \text{ V}$, $T_A = 25 \text{ }^\circ\text{C}$, $R_L = 1 \text{ k}\Omega$, $I_F = 10 \text{ mA}$	SFH6156-2	t_r		3		μs
		SFH6156-3	t_r		3		μs
Fall time	$V_{CC} = 5 \text{ V}$, $T_A = 25 \text{ }^\circ\text{C}$, $R_L = 1 \text{ k}\Omega$, $I_F = 20 \text{ mA}$	SFH6156-1	t_f		11		μs
	$V_{CC} = 5 \text{ V}$, $T_A = 25 \text{ }^\circ\text{C}$, $R_L = 1 \text{ k}\Omega$, $I_F = 10 \text{ mA}$	SFH6156-2	t_f		14		μs
		SFH6156-3	t_f		14		μs
Turn-on time	$V_{CC} = 5 \text{ V}$, $T_A = 25 \text{ }^\circ\text{C}$, $R_L = 1 \text{ k}\Omega$, $I_F = 20 \text{ mA}$	SFH6156-1	t_{on}		3		μs
	$V_{CC} = 5 \text{ V}$, $T_A = 25 \text{ }^\circ\text{C}$, $R_L = 1 \text{ k}\Omega$, $I_F = 10 \text{ mA}$	SFH6156-2	t_{on}		4.2		μs
		SFH6156-3	t_{on}		4.2		μs
Turn-off time	$V_{CC} = 5 \text{ V}$, $T_A = 25 \text{ }^\circ\text{C}$, $R_L = 1 \text{ k}\Omega$, $I_F = 20 \text{ mA}$	SFH6156-1	t_{off}		18		μs
	$V_{CC} = 5 \text{ V}$, $T_A = 25 \text{ }^\circ\text{C}$, $R_L = 1 \text{ k}\Omega$, $I_F = 10 \text{ mA}$	SFH6156-2	t_{off}		23		μs
		SFH6156-3	t_{off}		23		μs

SAFETY AND INSULATION RATINGS							
PARAMETER	TEST CONDITION	SYMBOL	MIN.	TYP.	MAX.	UNIT	
Climatic classification (according to IEC 68 part 1)				55/100/21			
Comparative tracking index		CTI	175		399		
V_{IOTM}		V_{IOTM}	10 000			V_{peak}	
V_{IORM}		V_{IORM}	890			V_{peak}	
P_{SO}		P_{SO}			400	mW	
I_{SI}		I_{SI}			275	mA	
T_{SI}		T_{SI}			175	$^\circ\text{C}$	
Creepage distance			7			mm	
Clearance distance			7			mm	
Insulation thickness, reinforced rated	per IEC 60950 2.10.5.1		0.4			mm	

Note

- As per IEC 60747-5-5, § 7.4.3.8.2, this optocoupler is suitable for "safe electrical insulation" only within the safety ratings. Compliance with the safety ratings shall be ensured by means of protective circuits.



TYPICAL CHARACTERISTICS ($T_{amb} = 25\text{ }^{\circ}\text{C}$, unless otherwise specified)



isfh615a_01

Fig. 2 - Linear Operation (without Saturation)

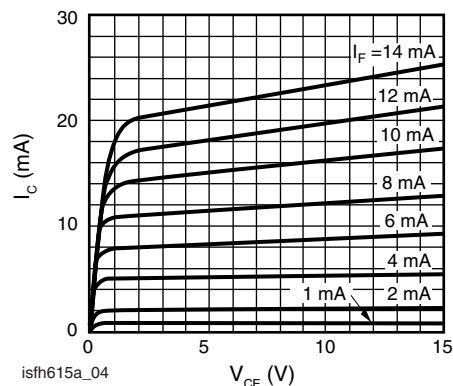

isfh615a_04

Fig. 5 - Output Characteristics (Typ.) Collector Current vs. Collector Emitter Voltage



isfh615a_02

Fig. 3 - Switching Operation (with Saturation)

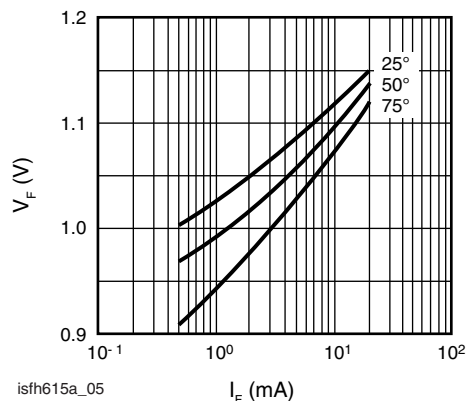

isfh615a_05

Fig. 6 - Diode Forward Voltage (Typ.) vs. Forward Current

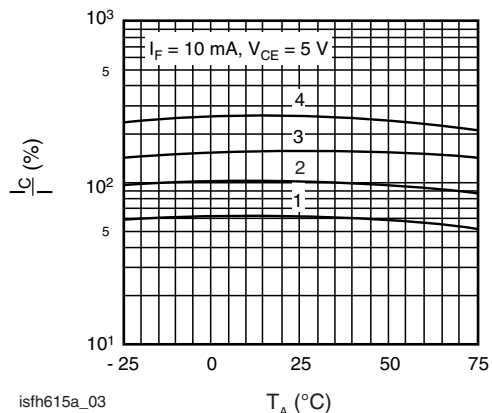

isfh615a_03

Fig. 4 - Current Transfer Ratio (Typ.) vs. Temperature



isfh615a_06

Fig. 7 - Transistor Capacitance (Typ.) vs. Collector Emitter Voltage

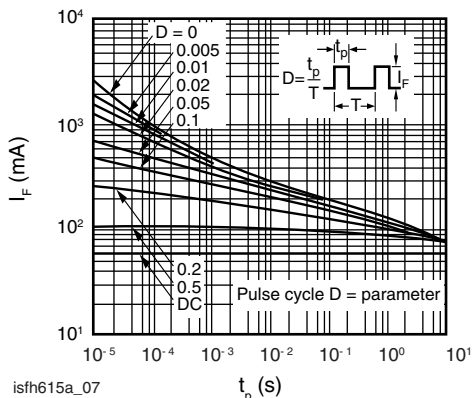

Fig. 8 - Permissible Pulse Handling Capability Forward Current vs. Pulse Width

PACKAGE DIMENSIONS millimeters



i178029_11

PACKAGE MARKING (example of SFH6156-2X001T)



Notes

- VDE logo is only marked on option 1 parts.
- Tape and reel suffix (T) is not part of the package marking.



Disclaimer

ALL PRODUCT, PRODUCT SPECIFICATIONS AND DATA ARE SUBJECT TO CHANGE WITHOUT NOTICE TO IMPROVE RELIABILITY, FUNCTION OR DESIGN OR OTHERWISE.

Vishay Intertechnology, Inc., its affiliates, agents, and employees, and all persons acting on its or their behalf (collectively, "Vishay"), disclaim any and all liability for any errors, inaccuracies or incompleteness contained in any datasheet or in any other disclosure relating to any product.

Vishay makes no warranty, representation or guarantee regarding the suitability of the products for any particular purpose or the continuing production of any product. To the maximum extent permitted by applicable law, Vishay disclaims (i) any and all liability arising out of the application or use of any product, (ii) any and all liability, including without limitation special, consequential or incidental damages, and (iii) any and all implied warranties, including warranties of fitness for particular purpose, non-infringement and merchantability.

Statements regarding the suitability of products for certain types of applications are based on Vishay's knowledge of typical requirements that are often placed on Vishay products in generic applications. Such statements are not binding statements about the suitability of products for a particular application. It is the customer's responsibility to validate that a particular product with the properties described in the product specification is suitable for use in a particular application. Parameters provided in datasheets and/or specifications may vary in different applications and performance may vary over time. All operating parameters, including typical parameters, must be validated for each customer application by the customer's technical experts. Product specifications do not expand or otherwise modify Vishay's terms and conditions of purchase, including but not limited to the warranty expressed therein.

Except as expressly indicated in writing, Vishay products are not designed for use in medical, life-saving, or life-sustaining applications or for any other application in which the failure of the Vishay product could result in personal injury or death. Customers using or selling Vishay products not expressly indicated for use in such applications do so at their own risk. Please contact authorized Vishay personnel to obtain written terms and conditions regarding products designed for such applications.

No license, express or implied, by estoppel or otherwise, to any intellectual property rights is granted by this document or by any conduct of Vishay. Product names and markings noted herein may be trademarks of their respective owners.

Material Category Policy

Vishay Intertechnology, Inc. hereby certifies that all its products that are identified as RoHS-Compliant fulfill the definitions and restrictions defined under Directive 2011/65/EU of The European Parliament and of the Council of June 8, 2011 on the restriction of the use of certain hazardous substances in electrical and electronic equipment (EEE) - recast, unless otherwise specified as non-compliant.

Please note that some Vishay documentation may still make reference to RoHS Directive 2002/95/EC. We confirm that all the products identified as being compliant to Directive 2002/95/EC conform to Directive 2011/65/EU.

Vishay Intertechnology, Inc. hereby certifies that all its products that are identified as Halogen-Free follow Halogen-Free requirements as per JEDEC JS709A standards. Please note that some Vishay documentation may still make reference to the IEC 61249-2-21 definition. We confirm that all the products identified as being compliant to IEC 61249-2-21 conform to JEDEC JS709A standards.

Компания «Океан Электроники» предлагает заключение долгосрочных отношений при поставках импортных электронных компонентов на взаимовыгодных условиях!

Наши преимущества:

- Поставка оригинальных импортных электронных компонентов напрямую с производств Америки, Европы и Азии, а так же с крупнейших складов мира;
- Широкая линейка поставок активных и пассивных импортных электронных компонентов (более 30 млн. наименований);
- Поставка сложных, дефицитных, либо снятых с производства позиций;
- Оперативные сроки поставки под заказ (от 5 рабочих дней);
- Экспресс доставка в любую точку России;
- Помощь Конструкторского Отдела и консультации квалифицированных инженеров;
- Техническая поддержка проекта, помощь в подборе аналогов, поставка прототипов;
- Поставка электронных компонентов под контролем ВП;
- Система менеджмента качества сертифицирована по Международному стандарту ISO 9001;
- При необходимости вся продукция военного и аэрокосмического назначения проходит испытания и сертификацию в лаборатории (по согласованию с заказчиком);
- Поставка специализированных компонентов военного и аэрокосмического уровня качества (Xilinx, Altera, Analog Devices, Intersil, Interpoint, Microsemi, Actel, Aeroflex, Peregrine, VPT, Syfer, Eurofarad, Texas Instruments, MS Kennedy, Miteq, Cobham, E2V, MA-COM, Hittite, Mini-Circuits, General Dynamics и др.);

Компания «Океан Электроники» является официальным дистрибьютором и эксклюзивным представителем в России одного из крупнейших производителей разъемов военного и аэрокосмического назначения «JONHON», а так же официальным дистрибьютором и эксклюзивным представителем в России производителя высокотехнологичных и надежных решений для передачи СВЧ сигналов «FORSTAR».



JONHON

«JONHON» (основан в 1970 г.)

Разъемы специального, военного и аэрокосмического назначения:

(Применяются в военной, авиационной, аэрокосмической, морской, железнодорожной, горно- и нефтедобывающей отраслях промышленности)

«FORSTAR» (основан в 1998 г.)

ВЧ соединители, коаксиальные кабели, кабельные сборки и микроволновые компоненты:

(Применяются в телекоммуникациях гражданского и специального назначения, в средствах связи, РЛС, а так же военной, авиационной и аэрокосмической отраслях промышленности).



Телефон: 8 (812) 309-75-97 (многоканальный)

Факс: 8 (812) 320-03-32

Электронная почта: ocean@oceanchips.ru

Web: <http://oceanchips.ru/>

Адрес: 198099, г. Санкт-Петербург, ул. Калинина, д. 2, корп. 4, лит. А