

# Low RF Susceptibility DirectDrive Stereo Headphone Amplifier with 1.8V Compatible Shutdown

## General Description

The MAX9724C/MAX9724D stereo headphone amplifiers are designed for portable equipment where board space is at a premium. These devices use a unique, DirectDrive® architecture to produce a ground-referenced output from a single supply, eliminating the need for large DC-blocking capacitors, saving cost, board space, and component height. The MAX9724 suppresses RF radiation received by input and supply traces acting as antennas and prevents the amplifier from demodulating the coupled noise. The MAX9724C offers an externally adjustable gain while the MAX9724D has an internally preset gain of -1.5V/V. The MAX9724C/MAX9724D deliver up to 60mW per channel into a 32Ω load and have low 0.02% THD+N. An 80dB at 1kHz power-supply rejection ratio (PSRR) allows these devices to operate from noisy digital supplies without an additional linear regulator. Comprehensive click-and-pop circuitry suppresses audible clicks and pops on startup and shutdown.

The MAX9724C/MAX9724D operate from a single 2.5V to 5.5V supply, consume only 3.5mA of supply current, feature short-circuit and thermal-overload protection, and are specified over the extended -40°C to +85°C temperature range. The devices are available in tiny 12-bump UCSP™ (1.5mm x 2mm) and 12-pin thin QFN (3mm x 3mm x 0.8mm) packages.

## Applications

Cellular Phones	DVD Players
MP3 Players	Smart Phones
Notebook PCs	PDA's
Handheld Gaming Consoles	

Pin Configurations appear at end of data sheet.

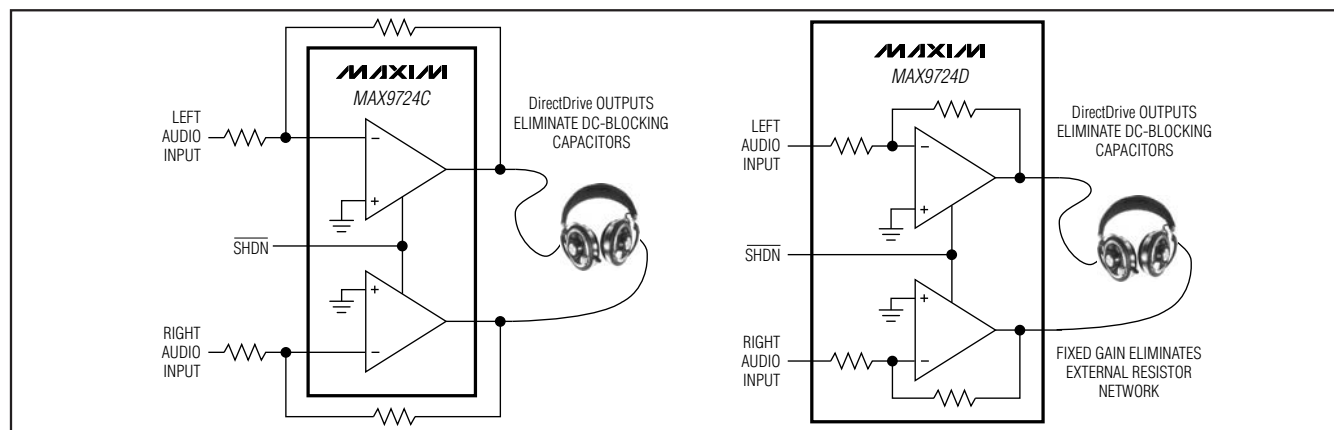

## Features

- ◆ Improved RF Noise Rejection (Up to 67dB Over Typical Amplifiers)
- ◆ No Bulky DC-Blocking Capacitors Required
- ◆ Low-Power Shutdown Mode, <math>< 0.1\mu\text{A}</math>
- ◆ Adjustable Gain (MAX9724C) or Fixed -1.5V/V Gain (MAX9724D)
- ◆ Low 0.02% THD+N
- ◆ High PSRR (80dB at 1kHz) Eliminates LDO
- ◆ Integrated Click-and-Pop Suppression
- ◆ 2.5V to 5.5V Single-Supply Operation
- ◆ Low Quiescent Current (3.5mA)
- ◆ Available in Space-Saving Packages
  - 12-Bump UCSP (1.5mm x 2mm)
  - 12-Pin Thin QFN (3mm x 3mm x 0.8mm)

## Ordering Information

PART	GAIN (V/V)	PIN-PACKAGE	TOP MARK
MAX9724CEBC+T	Adj.	12 UCSP	+AGE
MAX9724CETC+	Adj.	12 TQFN-EP*	+ABJ
MAX9724DEBC+T	-1.5	12 UCSP	+AEH
MAX9724DETC+	-1.5	12 TQFN-EP*	+ABK

**Note:** All devices specified over the -40°C to +85°C operating range.

+Denotes a lead-free package.

T = Tape and reel.

\*EP = Exposed pad.

DirectDrive is a registered trademark of Maxim Integrated Products, Inc.

UCSP is a trademark of Maxim Integrated Products, Inc.

## Block Diagrams

# Low RF Susceptibility DirectDrive Stereo Headphone Amplifier with 1.8V Compatible Shutdown

## ABSOLUTE MAXIMUM RATINGS

V <sub>DD</sub> to GND	-0.3V to +6V
PVSS to SVSS	-0.3V to +0.3V
PGND to SGND	-0.3V to +0.3V
C1P to PGND	-0.3V to (V <sub>DD</sub> + 0.3V)
C1N to PGND	(PVSS - 0.3V) to +0.3V
PVSS and SVSS to PGND	-6V to +0.3V
IN <sub>-</sub> to SGND (MAX9724C)	-0.3V to (V <sub>DD</sub> + 0.3V)
IN <sub>-</sub> to SGND (MAX9724D)	(SVSS - 0.3V) to (V <sub>DD</sub> + 0.3V)
OUT <sub>-</sub> to SVSS (Note 1)	-0.3V to Min (V <sub>DD</sub> - SVSS + 0.3V, +9V)
OUT <sub>-</sub> to V <sub>DD</sub> (Note 2)	+0.3V to Max (SVSS - V <sub>DD</sub> - 0.3V, -9V)
SHDN to GND	-0.3V to +6V
OUT <sub>-</sub> Short Circuit to GND	Continuous
Short Circuit between OUTL and OUTR	Continuous

Continuous Input Current into PVSS	260mA
Continuous Input Current (any other pin)	±20mA
Continuous Power Dissipation (T <sub>A</sub> = +70°C, multilayer board)	
12-Bump UCSP (derate 6.5mW/°C above +70°C)	519mW
θ <sub>JA</sub>	154 C/W
12-Pin TQFN (derate 16.7mW/°C above +70°C)	1333mW
θ <sub>JA</sub>	60°C/W
θ <sub>JC</sub>	11°C/W
Operating Temperature Range	-40°C to +85°C
Storage Temperature Range	-65°C to +150°C
Junction Temperature	+150°C
Lead Temperature (soldering, 10s)	+300°C
Bump Temperature (soldering) Reflow	+235°C

**Note 1:** OUTR and OUTL should be limited to no more than 9V above SVSS, or above V<sub>DD</sub> + 0.3V, whichever limits first.

**Note 2:** OUTR and OUTL should be limited to no more than 9V below V<sub>DD</sub>, or below SVSS - 0.3V, whichever limits first.

Stresses beyond those listed under "Absolute Maximum Ratings" may cause permanent damage to the device. These are stress ratings only, and functional operation of the device at these or any other conditions beyond those indicated in the operational sections of the specifications is not implied. Exposure to absolute maximum rating conditions for extended periods may affect device reliability.

## ELECTRICAL CHARACTERISTICS

(V<sub>DD</sub> = 5V, PGND = SGND, SHDN = 5V, C1 = C2 = 1μF, R<sub>L</sub> = ∞, resistive load reference to ground; for MAX9724C gain = -1.5V/V (R<sub>IN</sub> = 20kΩ, R<sub>F</sub> = 30kΩ); for MAX9724D gain = -1.5V/V (internally set), T<sub>A</sub> = -40°C to +85°C, unless otherwise noted. Typical values are at T<sub>A</sub> = +25°C, unless otherwise noted.) (Note 3)

PARAMETER	SYMBOL	CONDITIONS	MIN	TYP	MAX	UNITS
<b>GENERAL</b>						
Supply Voltage Range	V <sub>DD</sub>		2.5		5.5	V
Quiescent Current	I <sub>CC</sub>			3.5	5.5	mA
Shutdown Current	I <sub>SHDN</sub>	SHDN = SGND = PGND		0.1	1	μA
Shutdown to Full Operation	t <sub>SON</sub>			180		μs
Input Impedance	R <sub>IN</sub>	MAX9724D, measured at IN <sub>-</sub>	12	19	28	kΩ
Output Offset Voltage	V <sub>OS</sub>	T <sub>A</sub> = +25°C (Note 4)		±1.5	±10	mV
Power-Supply Rejection Ratio	PSRR	V <sub>DD</sub> = 2.7V to 5.5V, T <sub>A</sub> = +25°C	69	86		dB
		f = 1kHz, 100mV <sub>p-p</sub> (Note 4)		80		
		f = 20kHz, 100mV <sub>p-p</sub> (Note 4)		65		
Output Power (TQFN)	P <sub>OUT</sub>	R <sub>L</sub> = 32Ω, THD+N = 1%	30	63		mW
		R <sub>L</sub> = 16Ω, THD+N = 1%		42		
Output Power (UCSP)	P <sub>OUT</sub>	R <sub>L</sub> = 32Ω, THD+N = 1%	25	45		mW
		R <sub>L</sub> = 16Ω, THD+N = 1%		35		
Voltage Gain	A <sub>V</sub>	MAX9724D (Note 5)	-1.52	-1.5	-1.48	V/V
Channel-to-Channel Gain Tracking		MAX9724D		±0.15		%
Total Harmonic Distortion Plus Noise (TQFN) (Note 6)	THD+N	R <sub>L</sub> = 1kΩ, V <sub>OUT</sub> = 2V <sub>RMS</sub> , f <sub>IN</sub> = 1kHz		0.003		%
		R <sub>L</sub> = 32Ω, P <sub>OUT</sub> = 50mW, f <sub>IN</sub> = 1kHz		0.02		
		R <sub>L</sub> = 16Ω, P <sub>OUT</sub> = 35mW, f <sub>IN</sub> = 1kHz		0.04		
Total Harmonic Distortion Plus Noise (UCSP) (Note 6)	THD+N	R <sub>L</sub> = 1kΩ, V <sub>OUT</sub> = 2V <sub>RMS</sub> , f <sub>IN</sub> = 1kHz		0.003		%
		R <sub>L</sub> = 32Ω, P <sub>OUT</sub> = 45mW, f <sub>IN</sub> = 1kHz		0.03		
		R <sub>L</sub> = 16Ω, P <sub>OUT</sub> = 32mW, f <sub>IN</sub> = 1kHz		0.05		
Signal-to-Noise Ratio	SNR	R <sub>L</sub> = 1kΩ, V <sub>OUT</sub> = 2V <sub>RMS</sub>	BW = 22Hz to 22kHz	102		dB
			A-weighted	105		
		R <sub>L</sub> = 32Ω, P <sub>OUT</sub> = 50mW	BW = 22Hz to 22kHz	98		
			A-weighted	101		

# Low RF Susceptibility DirectDrive Stereo Headphone Amplifier with 1.8V Compatible Shutdown

MAX9724C/MAX9724D

## ELECTRICAL CHARACTERISTICS (continued)

( $V_{DD} = 5V$ ,  $PGND = SGND$ ,  $\overline{SHDN} = 5V$ ,  $C1 = C2 = 1\mu F$ ,  $R_L = \infty$ , resistive load reference to ground; for MAX9724C gain =  $-1.5V/V$  ( $R_{IN} = 20k\Omega$ ,  $R_F = 30k\Omega$ ); for MAX9724D gain =  $-1.5V/V$  (internally set),  $T_A = -40^\circ C$  to  $+85^\circ C$ , unless otherwise noted. Typical values are at  $T_A = +25^\circ C$ , unless otherwise noted.) (Note 3)

PARAMETER	SYMBOL	CONDITIONS	MIN	TYP	MAX	UNITS
Slew Rate	SR			0.5		V/ $\mu s$
Capacitive Drive	$C_L$	No sustained oscillations		100		pF
Crosstalk		L to R, R to L, $f = 10kHz$ , $R_L = 16\Omega$ , $P_{OUT} = 15mW$		-70		dB
Charge-Pump Oscillator Frequency	$f_{OSC}$		190	270	400	kHz
Click-and-Pop Level	$K_{CP}$	$R_L = 32\Omega$ , peak voltage, A-weighted, 32 samples per second (Notes 4, 7)	Into shutdown	-67		dB
			Out of shutdown	-64		
<b>DIGITAL INPUTS (<math>\overline{SHDN}</math>)</b>						
Input-Voltage High	$V_{INH}$		1.4			V
Input-Voltage Low	$V_{INL}$				0.4	V
Input Leakage Current					$\pm 1$	$\mu A$

## ELECTRICAL CHARACTERISTICS

( $V_{DD} = 3V$ ,  $PGND = SGND$ ,  $\overline{SHDN} = 3V$ ,  $C1 = C2 = 1\mu F$ ,  $R_L = \infty$ , resistive load reference to ground; for MAX9724C gain =  $-1.5V/V$  ( $R_{IN} = 20k\Omega$ ,  $R_F = 30k\Omega$ ); for MAX9724D gain =  $-1.5V/V$  (internally set),  $T_A = -40^\circ C$  to  $+85^\circ C$ , unless otherwise noted. Typical values are at  $T_A = +25^\circ C$ , unless otherwise noted.) (Note 3)

PARAMETER	SYMBOL	CONDITIONS	MIN	TYP	MAX	UNITS
Quiescent Current	$I_{CC}$			3.0		mA
Shutdown Current	$I_{SHDN}$	$\overline{SHDN} = SGND = PGND$		0.1		$\mu A$
Power-Supply Rejection Ratio (Note 4)	PSRR	$f = 1kHz$ , 100mVp-p		80		dB
		$f = 20kHz$ , 100mVp-p		65		
Output Power (TQFN)	$P_{OUT}$	$R_L = 32\Omega$ , THD+N = 1%		20		mW
		$R_L = 16\Omega$ , THD+N = 1%		14		
Output Power (UCSP)	$P_{OUT}$	$R_L = 32\Omega$ , THD+N = 1%		17		mW
		$R_L = 16\Omega$ , THD+N = 1%		12		
Total Harmonic Distortion Plus Noise (TQFN) (Note 6)	THD+N	$R_L = 1k\Omega$ , $V_{OUT} = 2V_{RMS}$ , $f_{IN} = 1kHz$		0.05		%
		$R_L = 32\Omega$ , $P_{OUT} = 15mW$ , $f_{IN} = 1kHz$		0.03		
		$R_L = 16\Omega$ , $P_{OUT} = 10mW$ , $f_{IN} = 1kHz$		0.06		
Total Harmonic Distortion Plus Noise (UCSP) (Note 6)	THD+N	$R_L = 1k\Omega$ , $V_{OUT} = 2V_{RMS}$ , $f_{IN} = 1kHz$		0.003		%
		$R_L = 32\Omega$ , $P_{OUT} = 15mW$ , $f_{IN} = 1kHz$		0.04		
		$R_L = 16\Omega$ , $P_{OUT} = 10mW$ , $f_{IN} = 1kHz$		0.06		

**Note 3:** All specifications are 100% tested at  $T_A = +25^\circ C$ ; temperature limits are guaranteed by design.

**Note 4:** The amplifier inputs are AC-coupled to GND.

**Note 5:** Gain for the MAX9724C is adjustable.

**Note 6:** Measurement bandwidth is 22Hz to 22kHz.

**Note 7:** Test performed with a  $32\Omega$  resistive load connected to GND. Mode transitions are controlled by  $\overline{SHDN}$ .  $K_{CP}$  level is calculated as  $20\log[(\text{peak voltage during mode transition, no input signal})/(\text{peak voltage under normal operation at rated power level})]$ . Units are expressed in dB.

# Low RF Susceptibility DirectDrive Stereo Head-phone Amplifier with 1.8V Compatible Shutdown

## Typical Operating Characteristics

( $V_{DD} = 5V$ ,  $PGND = SGND = 0V$ ,  $\overline{SHDN} = V_{DD}$ ,  $C1 = C2 = 1\mu F$ ,  $R_L = \infty$ , gain =  $-1.5V/V$  ( $R_{IN} = 20k\Omega$ ,  $R_F = 30k\Omega$  for the MAX9724C), THD+N measurement bandwidth = 22Hz to 22kHz, both outputs driven in phase,  $T_A = +25^\circ C$ , unless otherwise noted.)

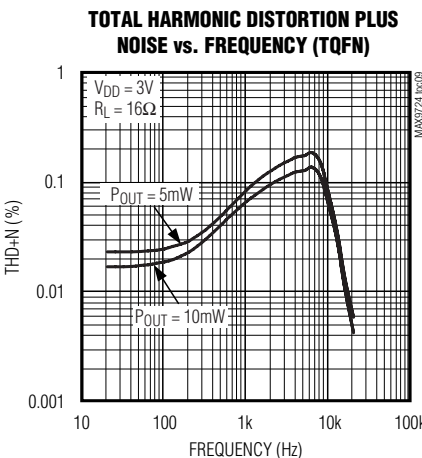
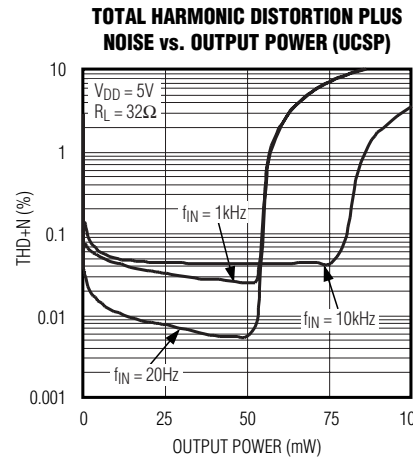
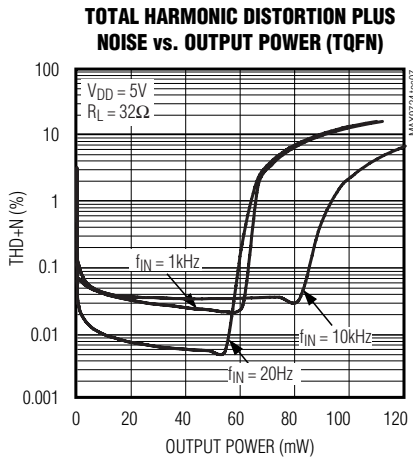
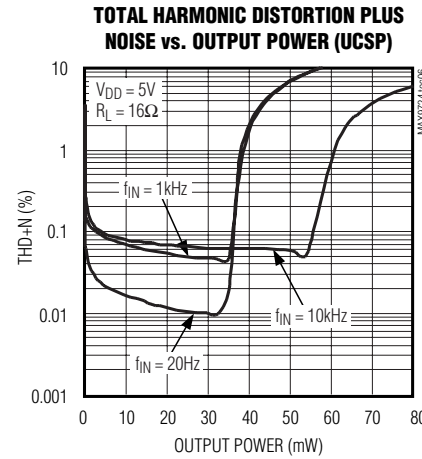
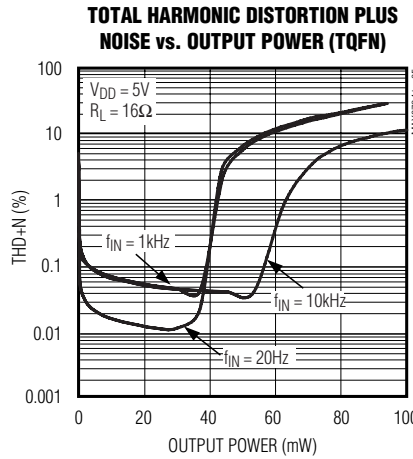
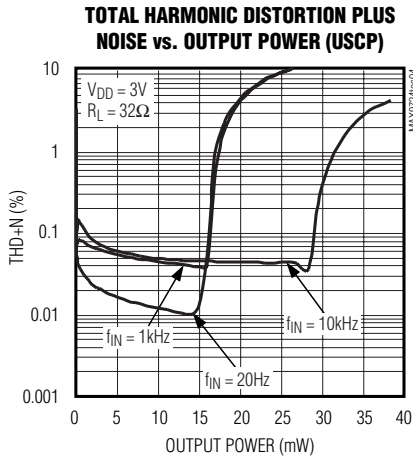
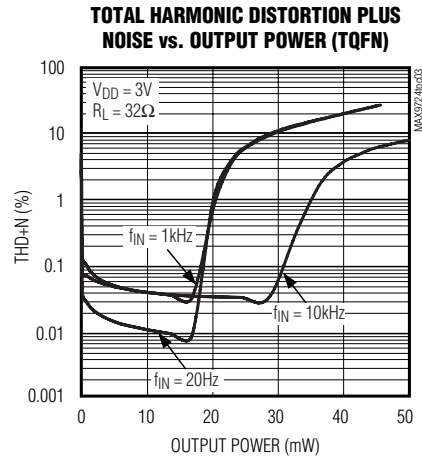
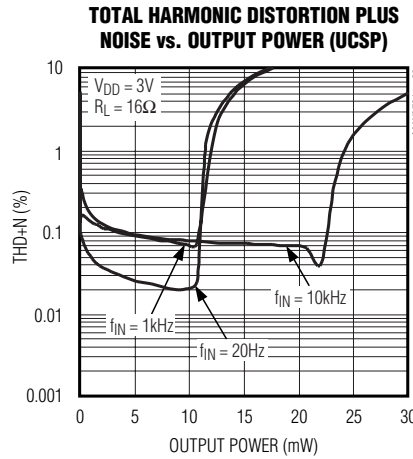
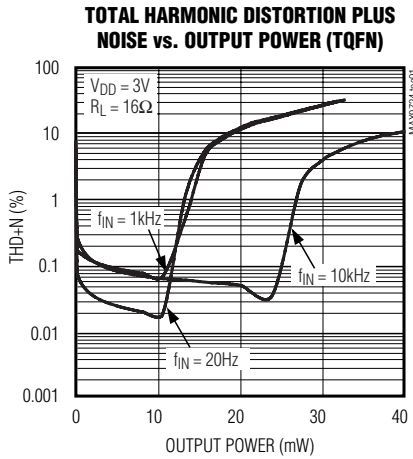

# Low RF Susceptibility DirectDrive Stereo Headphone Amplifier with 1.8V Compatible Shutdown

## Typical Operating Characteristics (continued)

( $V_{DD} = 5V$ ,  $PGND = SGND = 0V$ ,  $\overline{SHDN} = V_{DD}$ ,  $C1 = C2 = 1\mu F$ ,  $R_L = \infty$ , gain =  $-1.5V/V$  ( $R_{IN} = 20k\Omega$ ,  $R_F = 30k\Omega$  for the MAX9724C), THD+N measurement bandwidth = 22Hz to 22kHz, both outputs driven in phase,  $T_A = +25^\circ C$ , unless otherwise noted.)

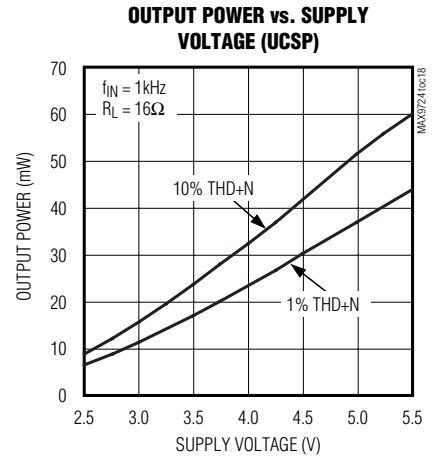
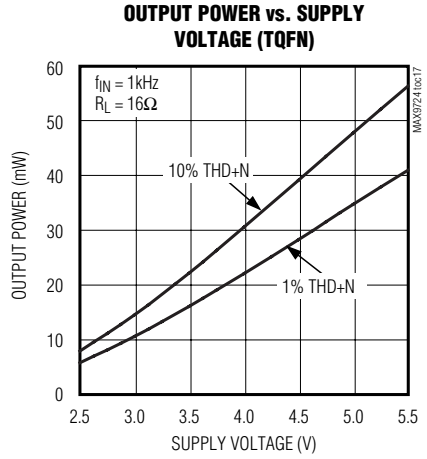
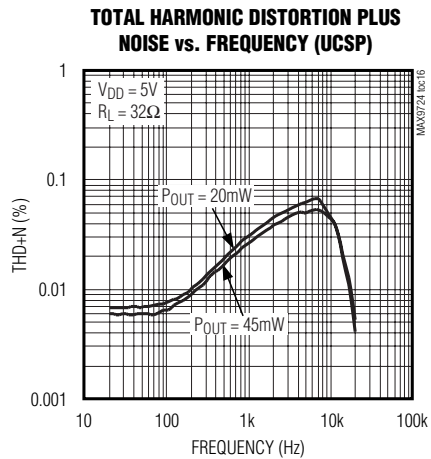
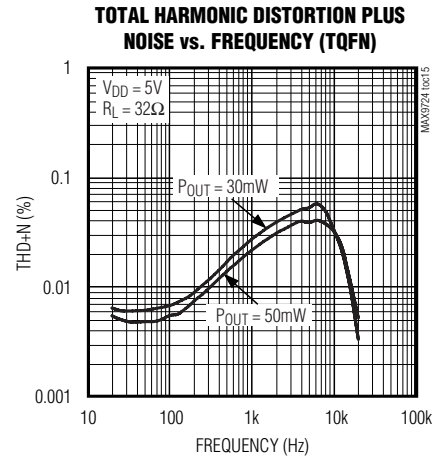
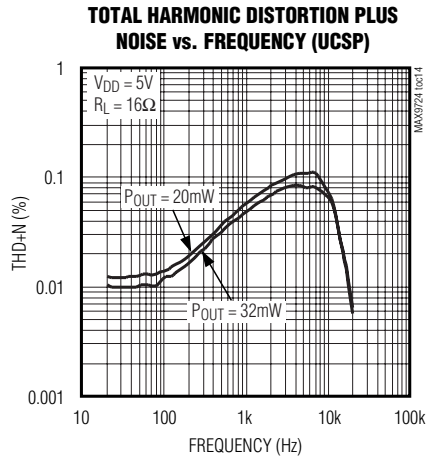
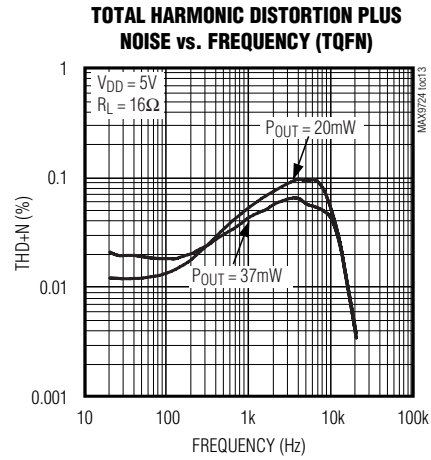
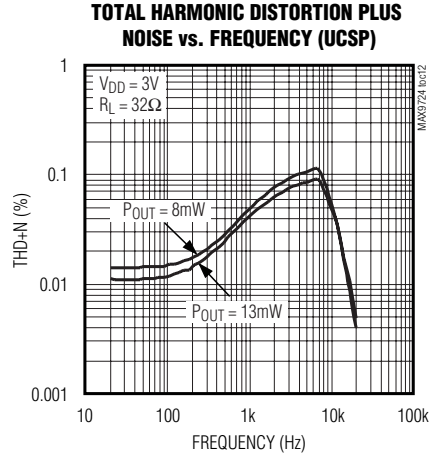
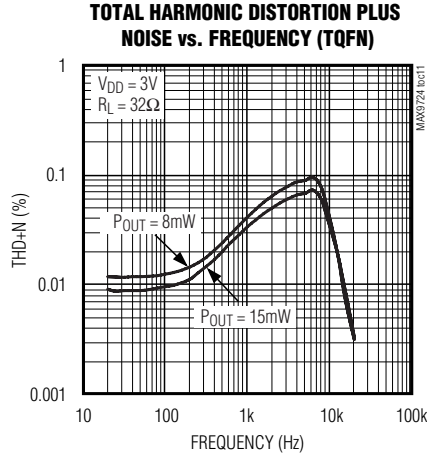
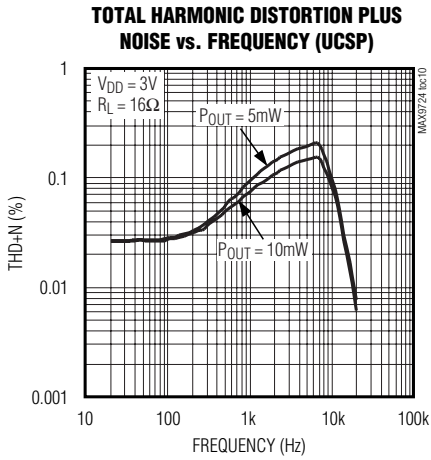

# Low RF Susceptibility DirectDrive Stereo Head-phone Amplifier with 1.8V Compatible Shutdown

## Typical Operating Characteristics (continued)

( $V_{DD} = 5V$ ,  $PGND = SGND = 0V$ ,  $\overline{SHDN} = V_{DD}$ ,  $C1 = C2 = 1\mu F$ ,  $R_L = \infty$ , gain =  $-1.5V/V$  ( $R_{IN} = 20k\Omega$ ,  $R_F = 30k\Omega$  for the MAX9724C), THD+N measurement bandwidth = 22Hz to 22kHz, both outputs driven in phase,  $T_A = +25^\circ C$ , unless otherwise noted.)

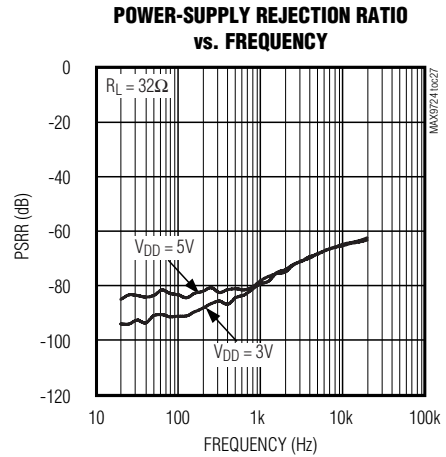
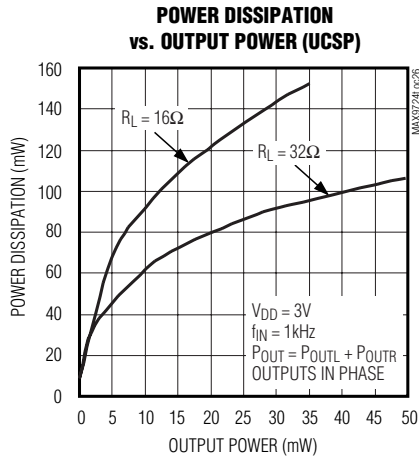
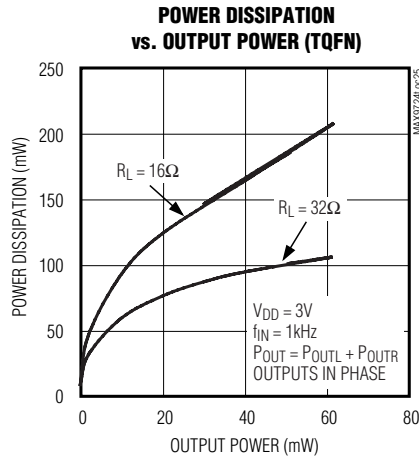
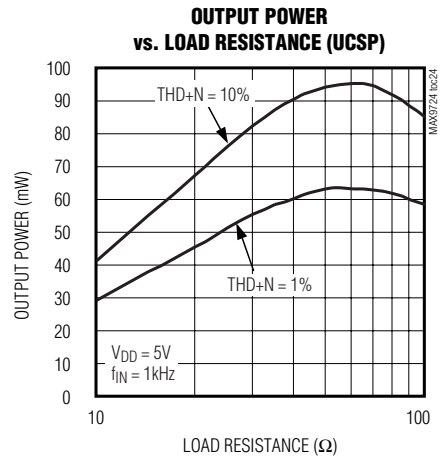
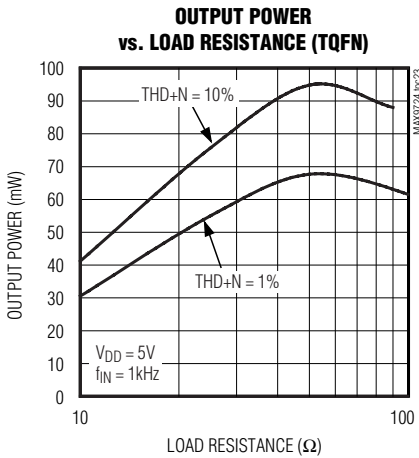
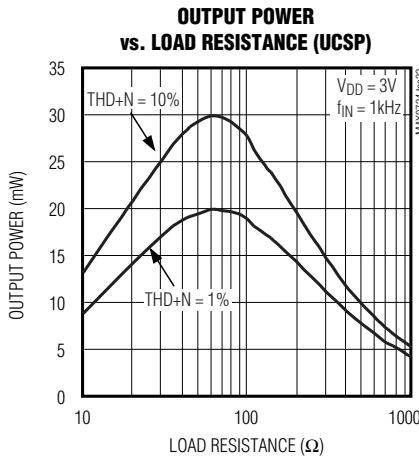
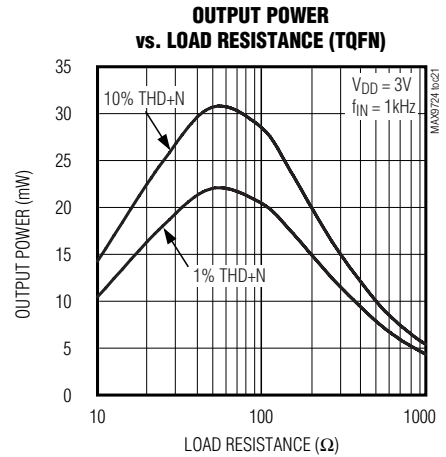
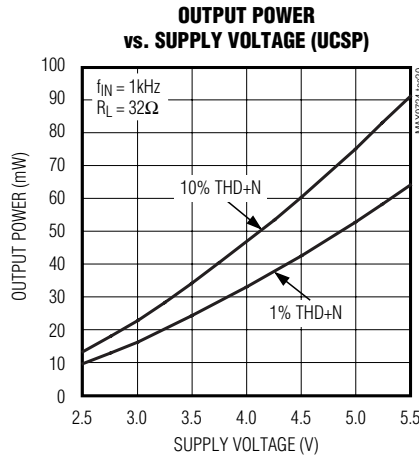
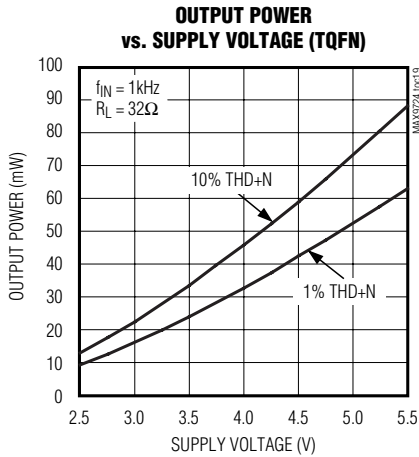

# Low RF Susceptibility DirectDrive Stereo Headphone Amplifier with 1.8V Compatible Shutdown

## Typical Operating Characteristics (continued)

( $V_{DD} = 5V$ ,  $PGND = SGND = 0V$ ,  $\overline{SHDN} = V_{DD}$ ,  $C1 = C2 = 1\mu F$ ,  $R_L = \infty$ , gain =  $-1.5V/V$  ( $R_{IN} = 20k\Omega$ ,  $R_F = 30k\Omega$  for the MAX9724C), THD+N measurement bandwidth = 22Hz to 22kHz, both outputs driven in phase,  $T_A = +25^\circ C$ , unless otherwise noted.)

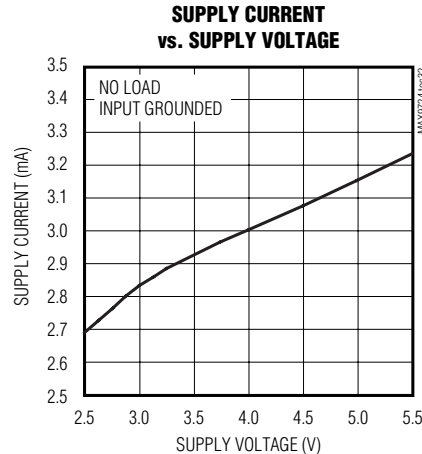
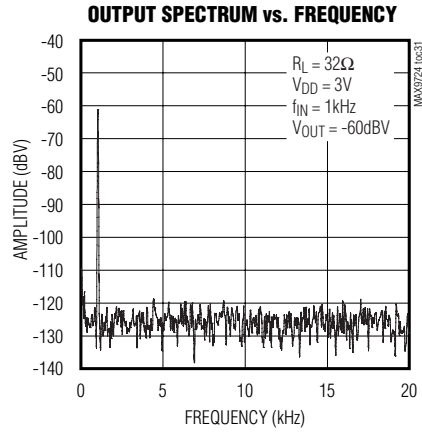
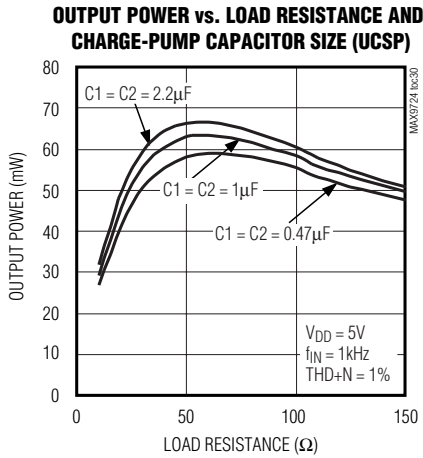
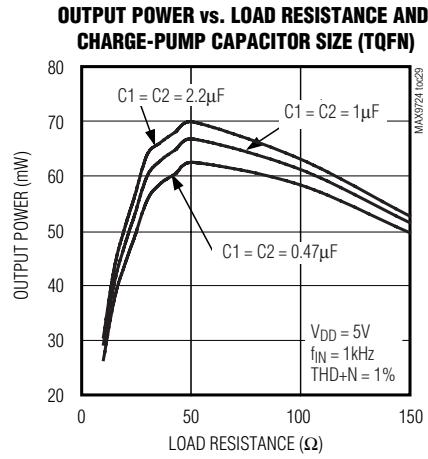
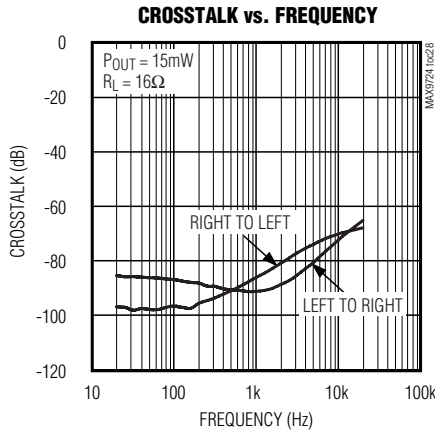

# Low RF Susceptibility DirectDrive Stereo Headphone Amplifier with 1.8V Compatible Shutdown

## Typical Operating Characteristics (continued)

( $V_{DD} = 5V$ ,  $PGND = SGND = 0V$ ,  $\overline{SHDN} = V_{DD}$ ,  $C1 = C2 = 1\mu F$ ,  $R_L = \infty$ , gain =  $-1.5V/V$  ( $R_{IN} = 20k\Omega$ ,  $R_F = 30k\Omega$  for the MAX9724C), THD+N measurement bandwidth = 22Hz to 22kHz, both outputs driven in phase,  $T_A = +25^\circ C$ , unless otherwise noted.)

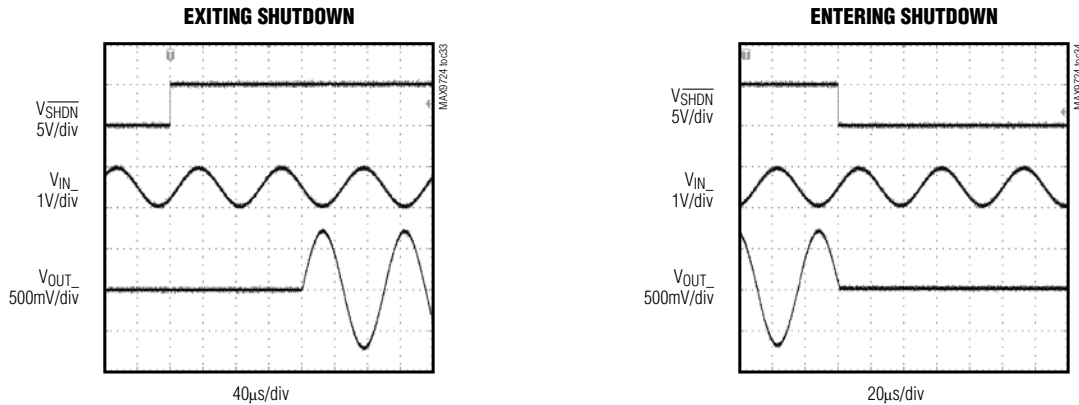

## Pin Description

PIN		NAME	FUNCTION
TQFN	UCSP		
1	C1	C1P	Flying Capacitor Positive Terminal. Connect a 1µF ceramic capacitor from C1P to C1N.
2	C2	PGND	Power Ground. Connect to SGND.
3	C3	C1N	Flying Capacitor Negative Terminal. Connect a 1µF ceramic capacitor from C1P to C1N.
4	C4	PVSS	Charge-Pump Output. Connect to SVSS and bypass with a 1µF ceramic capacitor to PGND.
5	A2	$\overline{SHDN}$	Active-Low Shutdown Input
6	B3	INL	Left-Channel Input
7	A1	SGND	Signal Ground. Connect to PGND.
8	B2	INR	Right-Channel Input
9	B4	SVSS	Amplifier Negative Supply. Connect to PVSS.
10	A3	OUTR	Right-Channel Output
11	A4	OUTL	Left-Channel Output
12	B1	VDD	Positive Power-Supply Input. Bypass with a 1µF capacitor to PGND.
EP	—	EP	Exposed Pad. Internally connected to SVSS. Connect to SVSS or leave unconnected.



# Low RF Susceptibility DirectDrive Stereo Headphone Amplifier with 1.8V Compatible Shutdown

## Detailed Description

The MAX9724C/MAX9724D stereo headphone amplifiers feature Maxim's DirectDrive architecture, eliminating the large output-coupling capacitors required by conventional single-supply headphone amplifiers. The device consists of two 60mW Class AB headphone amplifiers, undervoltage lockout (UVLO)/shutdown control, charge pump, and comprehensive click-and-pop suppression circuitry (see the *Functional Diagram/Typical Operating Circuits*). The charge pump inverts the positive supply ( $V_{DD}$ ), creating a negative supply (PVSS). The headphone amplifiers operate from these bipolar supplies with their outputs biased about PGND (Figure 1). The benefit of this PGND bias is that the amplifier outputs do not have a DC component. The large DC-blocking capacitors required with conventional headphone amplifiers are unnecessary, conserving board space, reducing system cost, and improving frequency response. The MAX9724C/MAX9724D feature an undervoltage lockout that prevents operation from an insufficient power supply and click-and-pop suppression that eliminates audible transients on startup and shutdown. The MAX9724C/MAX9724D also feature thermal-overload and short-circuit protection.

### DirectDrive

Conventional single-supply headphone amplifiers have their outputs biased about a nominal DC voltage (typically half the supply) for maximum dynamic range. Large-coupling capacitors are needed to block this DC bias from the headphone. Without these capacitors, a significant amount of DC current flows to the headphone, resulting in unnecessary power dissipation and possible damage to both headphone and headphone amplifier.

Maxim's DirectDrive architecture uses a charge pump to create an internal negative supply voltage, allowing the MAX9724C/MAX9724D outputs to be biased about GND. With no DC component, there is no need for the large DC-blocking capacitors. The MAX9724C/MAX9724D charge pumps require two small ceramic capacitors, conserving board space, reducing cost, and improving the frequency response of the headphone amplifier. See the Output Power vs. Load Resistance and Charge-Pump Capacitor Size graph in the *Typical Operating Characteristics* for details of the possible capacitor sizes. There is a low DC voltage on the amplifier outputs due to amplifier offset. However, the offsets of the MAX9724C/MAX9724D are typically 1.5mV, which, when combined with a 32 $\Omega$  load, results in less than 47 $\mu$ A of DC current flow to the headphones.

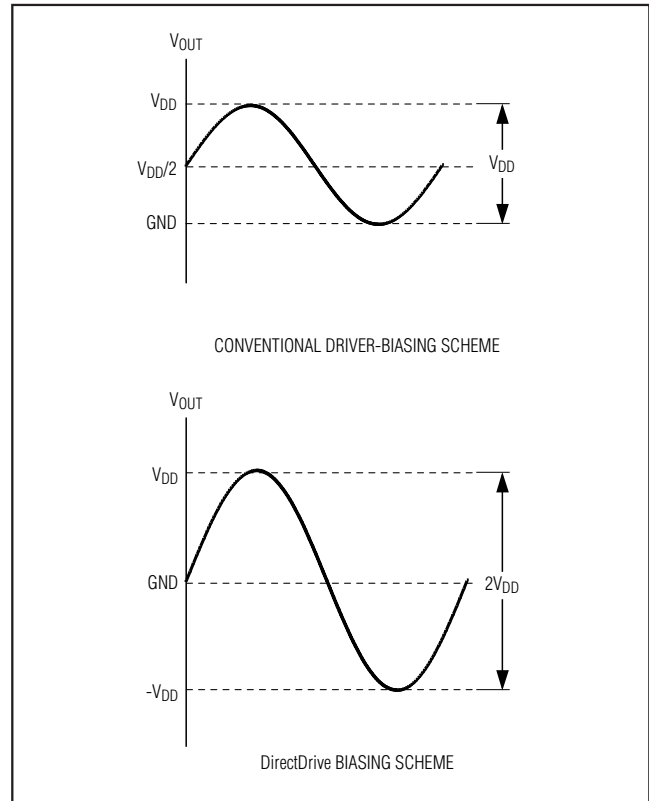

Figure 1. Conventional Driver Output Waveform vs. MAX9724C/MAX9724D Output Waveform

### Charge Pump

The MAX9724C/MAX9724D feature a low-noise charge pump. The 270kHz switching frequency is well beyond the audio range and does not interfere with audio signals. The switch drivers feature a controlled switching speed that minimizes noise generated by turn-on and turn-off transients. The di/dt noise caused by the parasitic bond wire and trace inductance is minimized by limiting the switching speed of the charge pump. Although not typically required, additional high-frequency noise attenuation can be achieved by increasing the value of C2 (see the *Functional Diagram/Typical Operating Circuits*).

### RF Susceptibility

Modern audio systems are often subject to RF radiation from sources like wireless networks and cellular phone networks. Although the RF radiation is out of the audio band, many signals, in particular GSM signals, contain bursts or modulation at audible frequencies. Most analog amplifiers demodulate the low-frequency envelope, adding noise to the audio signal. The architecture of

# Low RF Susceptibility DirectDrive Stereo Headphone Amplifier with 1.8V Compatible Shutdown

the MAX9724 addresses the problem of the RF susceptibility by rejecting RF noise and preventing it from coupling into the audio band.

The RF susceptibility of an amplifier can be measured by placing the amplifier in an isolated chamber and subjecting it to an electric field of known strength. If the electric field is modulated with an audio band signal, a percentage of the modulated signal is demodulated and amplified by the device in the chamber. Figure 2 shows the signal level at the outputs of an unoptimized amplifier and the MAX9724. The test conditions are shown in Table 1.

**Table 1. RF Susceptibility Test Conditions**

TEST PARAMETER	SETTING
RF Field Strength	50V/m
RF Modulation Type	Sine wave
RF Modulation Index	100%
RF Modulation Frequency	1kHz

### Click-and-Pop Suppression

In conventional single-supply audio amplifiers, the output-coupling capacitor contributes significantly to audible clicks and pops. Upon startup, the amplifier charges the coupling capacitor to its bias voltage, typically half the supply. Likewise, on shutdown, the capacitor is discharged. This results in a DC shift across the capacitor, which appears as an audible transient at the speaker. Since the MAX9724C/MAX9724D do not require output-coupling capacitors, this problem does not arise. Additionally, the MAX9724C/MAX9724D feature extensive click-and-pop suppression that eliminates any audible transient sources internal to the device.

Typically, the output of the device driving the MAX9724C/MAX9724D has a DC bias of half the supply voltage. At startup, the input-coupling capacitor, C<sub>IN</sub>, is charged to the preamplifier's DC bias voltage through the MAX9724C/MAX9724D input resistor, R<sub>IN</sub>, and a series 15kΩ resistor. This DC shift across the capacitor results in an audible click-and-pop. Delay the rise of  $\overline{\text{SHDN}}$  4 to 5 time constants based on R<sub>IN</sub> × 15kΩ × C<sub>IN</sub> to eliminate clicks-and-pops caused by the input filter.

### Shutdown

The MAX9724C/MAX9724D feature a < 0.1μA, low-power shutdown mode that reduces quiescent current consumption and extends battery life for portable applications. Drive  $\overline{\text{SHDN}}$  low to disable the amplifiers and the charge pump. In shutdown mode, the amplifier output impedance is set to 14kΩ||R<sub>F</sub> (R<sub>F</sub> is 30kΩ for the MAX9724D). The amplifiers and charge pump are enabled once  $\overline{\text{SHDN}}$  is driven high.

### Applications Information

#### Power Dissipation

Under normal operating conditions, linear power amplifiers can dissipate a significant amount of power. The maximum power dissipation for each package is given in the *Absolute Maximum Ratings* section under Continuous Power Dissipation or can be calculated by the following equation:

$$P_{\text{DISSPKG(MAX)}} = \frac{T_{\text{J(MAX)}} - T_{\text{A}}}{\theta_{\text{JA}}}$$

where T<sub>J(MAX)</sub> is +150°C, T<sub>A</sub> is the ambient temperature, and θ<sub>JA</sub> is the reciprocal of the derating factor in

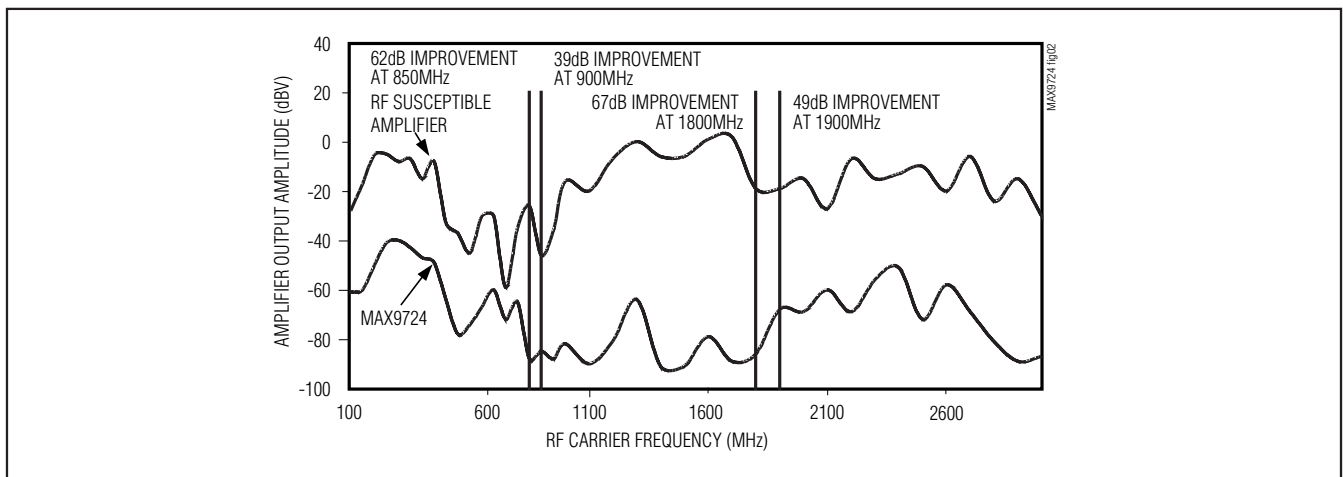

Figure 2. RF Susceptibility of the MAX9724 and a Typical Headphone Amplifier

# Low RF Susceptibility DirectDrive Stereo Headphone Amplifier with 1.8V Compatible Shutdown

°C/W as specified in the *Absolute Maximum Ratings* section. For example,  $\theta_{JA}$  of the thin QFN package is +68°C/W, and 154.2°C/W for the UCSP package.

The MAX9724C/MAX9724D have two power dissipation sources; a charge pump and the two output amplifiers. If power dissipation for a given application exceeds the maximum allowed for a particular package, reduce  $V_{DD}$ , increase load impedance, decrease the ambient temperature, or add heatsinking to the device. Large output, supply, and ground traces decrease  $\theta_{JA}$ , allowing more heat to be transferred from the package to the surrounding air.

Thermal-overload protection limits total power dissipation in the MAX9724C/MAX9724D. When the junction temperature exceeds +150°C, the thermal protection circuitry disables the amplifier output stage. The amplifiers are enabled once the junction temperature cools by approximately 12°C. This results in a pulsing output under continuous thermal-overload conditions.

## Output Dynamic Range

Dynamic range is the difference between the noise floor of the system and the output level at 1% THD+N. Determine the system's dynamic range before setting the maximum output gain. Output clipping occurs if the output signal is greater than the dynamic range of the system. The DirectDrive architecture of the MAX9724C/MAX9724D has increased the dynamic range compared to other single-supply amplifiers.

## Maximum Output Swing

### $V_{DD} < 4.35V$

If the output load impedance is greater than 1k $\Omega$ , the MAX9724C/MAX9724D can swing within a few millivolts of their supply rail. For example, with a 3.3V supply, the output swing is 2V<sub>RMS</sub>, or 2.83V peak while maintaining a low 0.003% THD+N. If the supply voltage drops to 3V, the same 2.83V peak has only 0.05% THD+N.

### $V_{DD} > 4.35V$

Internal device structures limit the maximum voltage swing of the MAX9724C/MAX9724D when operated at supply voltages greater than 4.35V. The output must not be driven such that the peak output voltage exceeds the

opposite supply voltage by 9V. For example, if  $V_{DD} = 5V$ , the charge pump sets  $PVSS = -5V$ . Therefore, the peak output swing must be less than  $\pm 4V$  to prevent exceeding the absolute maximum ratings.

## UVLO

The MAX9724C/MAX9724D feature an undervoltage lockout (UVLO) function that prevents the device from operating if the supply voltage is less than 2.5V. This feature ensures proper operation during brownout conditions and prevents deep battery discharge. Once the supply voltage exceeds the UVLO threshold, the MAX9724C/MAX9724D charge pump is turned on and the amplifiers are powered, provided that  $\overline{SHDN}$  is high.

## Component Selection

### Input-Coupling Capacitor

The input capacitor ( $C_{IN}$ ), in conjunction with the input resistor ( $R_{IN}$ ), forms a highpass filter that removes the DC bias from an incoming signal (see the *Functional Diagram/Typical Operating Circuits*). The AC-coupling capacitor allows the device to bias the signal to an optimum DC level. Assuming zero-source impedance, the -3dB point of the highpass filter is given by:

$$f_{-3dB} = \frac{1}{2\pi R_{IN} C_{IN}}$$

Choose the  $C_{IN}$  such that  $f_{-3dB}$  is well below the lowest frequency of interest. Setting  $f_{-3dB}$  too high affects the device's low-frequency response. Use capacitors whose dielectrics have low-voltage coefficients, such as tantalum or aluminum electrolytic. Capacitors with high-voltage coefficients, such as ceramics, can result in increased distortion at low frequencies.

### Charge-Pump Capacitor Selection

Use ceramic capacitors with a low ESR for optimum performance. For optimal performance over the extended temperature range, select capacitors with an X7R dielectric. Table 2 lists suggested manufacturers.

### Flying Capacitor (C1)

The value of the flying capacitor (see the *Functional Diagram/Typical Operating Circuits*) affects the charge

**Table 2. Suggested Capacitor Manufacturers**

SUPPLIER	PHONE	FAX	WEBSITE
Taiyo Yuden	800-348-2496	847-925-0899	www.t-yuden.com
TDK	847-803-6100	847-390-4405	www.component.tdk.com
Murata	770-436-1300	770-436-3030	www.murata.com

# Low RF Susceptibility DirectDrive Stereo Headphone Amplifier with 1.8V Compatible Shutdown

pump's load regulation and output resistance. A C1 value that is too small degrades the device's ability to provide sufficient current drive, which leads to a loss of output voltage. Increasing the value of C1 improves load regulation and reduces the charge-pump output resistance to an extent. See the Output Power vs. Load Resistance and Charge-Pump Capacitor Size graph in the *Typical Operating Characteristics*. Above 1 $\mu$ F, the on-resistance of the switches and the ESR of C1 and C2 dominate.

### Hold Capacitor (C2)

The hold capacitor value (see the *Functional Diagram/Typical Operating Circuits*) and ESR directly affect the ripple at PVSS. Increasing the value of C2 reduces output ripple. Likewise, decreasing the ESR of C2 reduces both ripple and output resistance. Lower capacitance values can be used in systems with low maximum output power levels. See the Output Power vs. Load Resistance and Charge-Pump Capacitor Size graph in the *Typical Operating Characteristics*.

### Power-Supply Bypass Capacitor (C3)

The power-supply bypass capacitor (see the *Functional Diagram/Typical Operating Circuits*) lowers the output impedance of the power supply and reduces the impact of the MAX9724C/MAX9724D's charge-pump switching transients. Bypass V<sub>DD</sub> with C3, the same value as C1, and place it physically close to the V<sub>DD</sub> and PGND pins.

### Amplifier Gain

The gain of the MAX9724D amplifier is internally set to -1.5V/V. All gain-setting resistors are integrated into the device, reducing external component count. The internally set gain, in combination with DirectDrive, results in a headphone amplifier that requires only five small capacitors to complete the amplifier circuit: two for the charge pump, two for audio input coupling, and one for power-supply bypassing (see the *Functional Diagram/Typical Operating Circuits*).

The gain of the MAX9724C amplifier is set externally as shown in Figure 3, the gain is:

$$A_V = -R_F/R_{IN} \text{ (V/V)}$$

Choose feedback resistor values in the tens of k $\Omega$  range. Lower values may cause excessive power dissipation and require impractically small values of R<sub>IN</sub> for large gain settings. The high-impedance state of the outputs can also be degraded during shutdown mode if an inadequate feedback resistor is used since the equivalent output impedance during shutdown is 14k $\Omega$ ||R<sub>F</sub> (R<sub>F</sub> is equal to 30k $\Omega$  for the MAX9724D). The source resistance of the input device may also need to be taken into consideration. Since the effective value of R<sub>IN</sub> is equal to the sum of the source resistance of the input device and the value of the input resistor connected to the inverting terminal of the headphone amplifier (20k $\Omega$  for the MAX9724D), the overall closed-loop gain of the headphone amplifier can be reduced if the input resistor is not significantly larger than the source resistance of the input device.

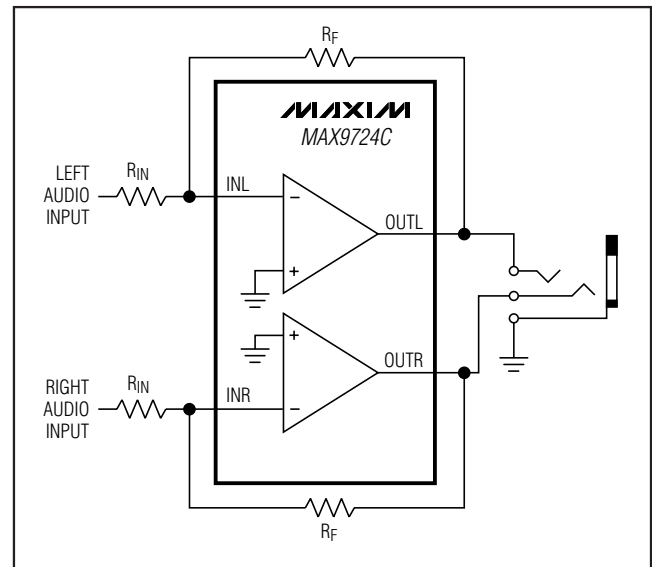

Figure 3. Gain Setting for the MAX9724C

# Low RF Susceptibility DirectDrive Stereo Headphone Amplifier with 1.8V Compatible Shutdown

## Lineout Amplifier and Filter Block

The MAX9724C can be used as an audio line driver capable of providing  $2V_{RMS}$  into  $10k\Omega$  loads with a single 5V supply (see Figure 4 for the RMS Output Voltage vs. Supply Voltage plot).  $2V_{RMS}$  is a popular audio line level, first used in CD players, but now common in DVD and set-top box (STB) interfacing standards. A  $2V_{RMS}$

sinusoidal signal equates to approximately 5.7V<sub>P-P</sub>, which means that the audio system designer cannot simply run the lineout stage from a (typically common) 5V supply—the resulting output swing would be inadequate. A common solution to this problem is to use op amps driven from split supplies ( $\pm 5V$  typically), or to use a high-voltage supply rail (9V to 12V). This can mean adding extra cost and complexity to the system power supply to meet this output level requirement. Having the ability to derive  $2V_{RMS}$  from a 5V supply, or even 3.3V supply, can often simplify power-supply design in some systems.

When the MAX9724C is used as a line driver to provide outputs that feed stereo equipment (receivers, STBs, notebooks, and desktops) with a digital-to-analog converter (DAC) used as an audio input source, it is often desirable to eliminate any high-frequency quantization noise produced by the DAC output before it reaches the load. This high-frequency noise can cause the input stages of the line-in equipment to exceed slew-rate limitations or create excessive EMI emissions on the cables between devices.

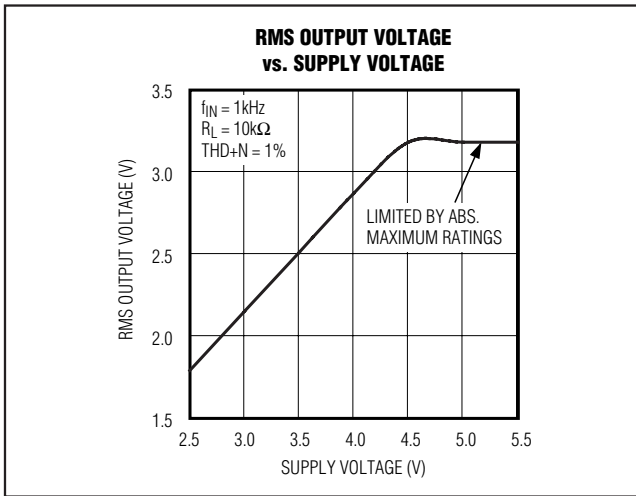

Figure 4. RMS Output Voltage vs. Supply Voltage

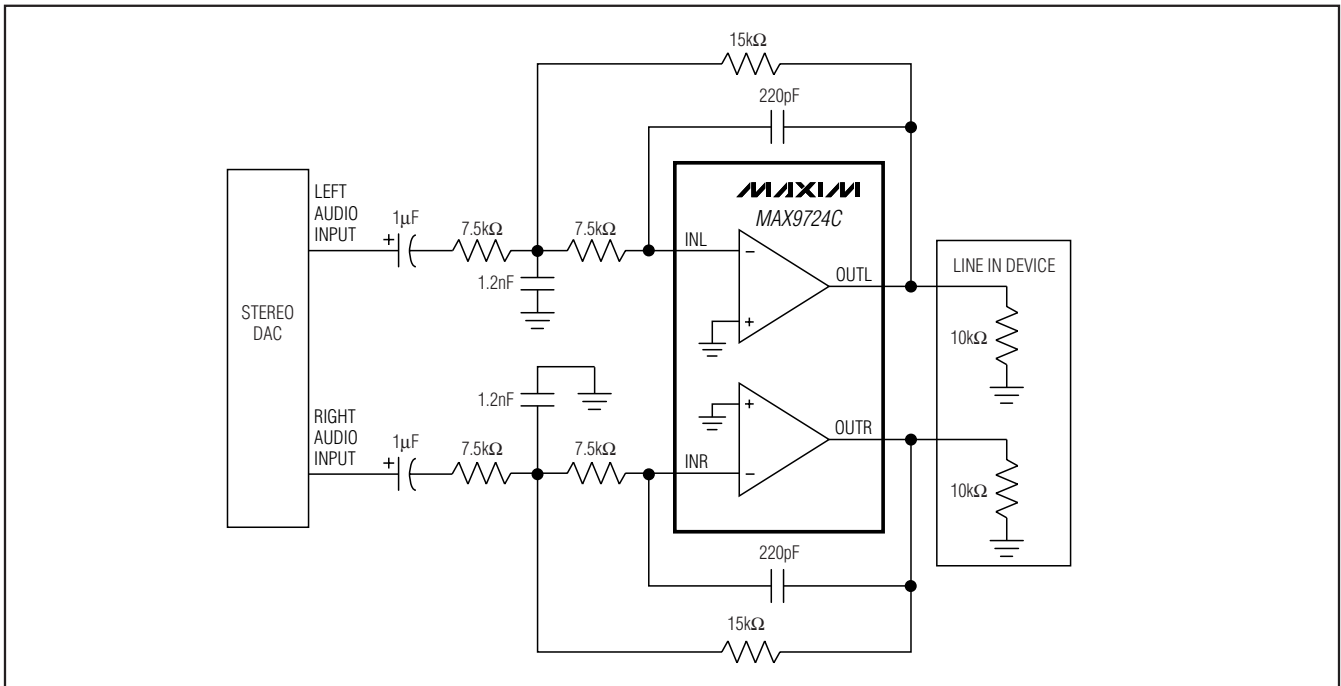

Figure 5. MAX9724C Line Out Amplifier and Filter Block Configuration

## Low RF Susceptibility DirectDrive Stereo Headphone Amplifier with 1.8V Compatible Shutdown

To suppress this noise, and to provide a  $2V_{RMS}$  standard audio output level from a single 5V supply, the MAX9724C can be configured as a line driver and active lowpass filter. Figure 5 shows the MAX9724C connected as 2-pole Rauch/multiple feedback filter with a passband gain of 6dB and a -3dB (below passband) cutoff frequency of approximately 27kHz (see Figure 6 for the Gain vs. Frequency plot).

### Layout and Grounding

Proper layout and grounding are essential for optimum performance. Connect PGND and SGND together at a single point on the PCB. Connect PVSS to SVSS and bypass with a  $1\mu F$  capacitor. Place the power-supply bypass capacitor and the charge-pump hold capacitor as close to the MAX9724 as possible. Route PGND and all traces that carry switching transients away from SGND and the audio signal path. The thin QFN package features an exposed pad that improves thermal efficiency. **Ensure that the exposed pad is electrically isolated from PGND, SGND, and  $V_{DD}$ . Connect the exposed paddle to SVSS only when the board layout dictates that the exposed pad cannot be left floating.**

### UCSP Applications Information

For the latest application details on UCSP construction, dimensions, tape carrier information, PCB techniques, bump-pad layout, and recommended reflow temperature profile, as well as the latest information on reliability testing results, refer to the Application Note *UCSP—A Wafer-Level Chip-Scale Package* available on Maxim's website at [www.maxim-ic.com/ucsp](http://www.maxim-ic.com/ucsp).

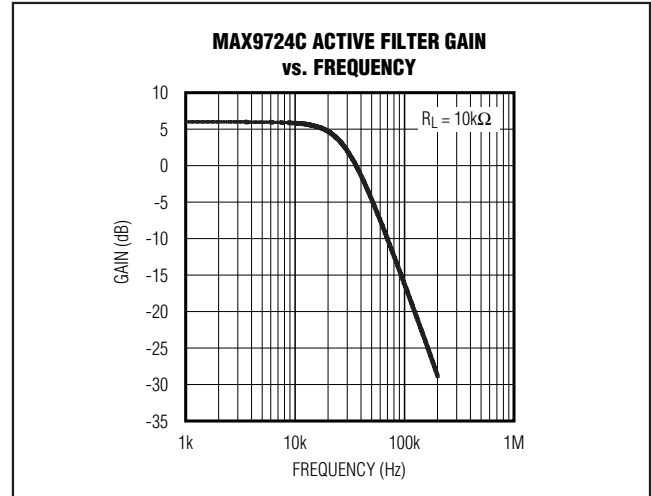
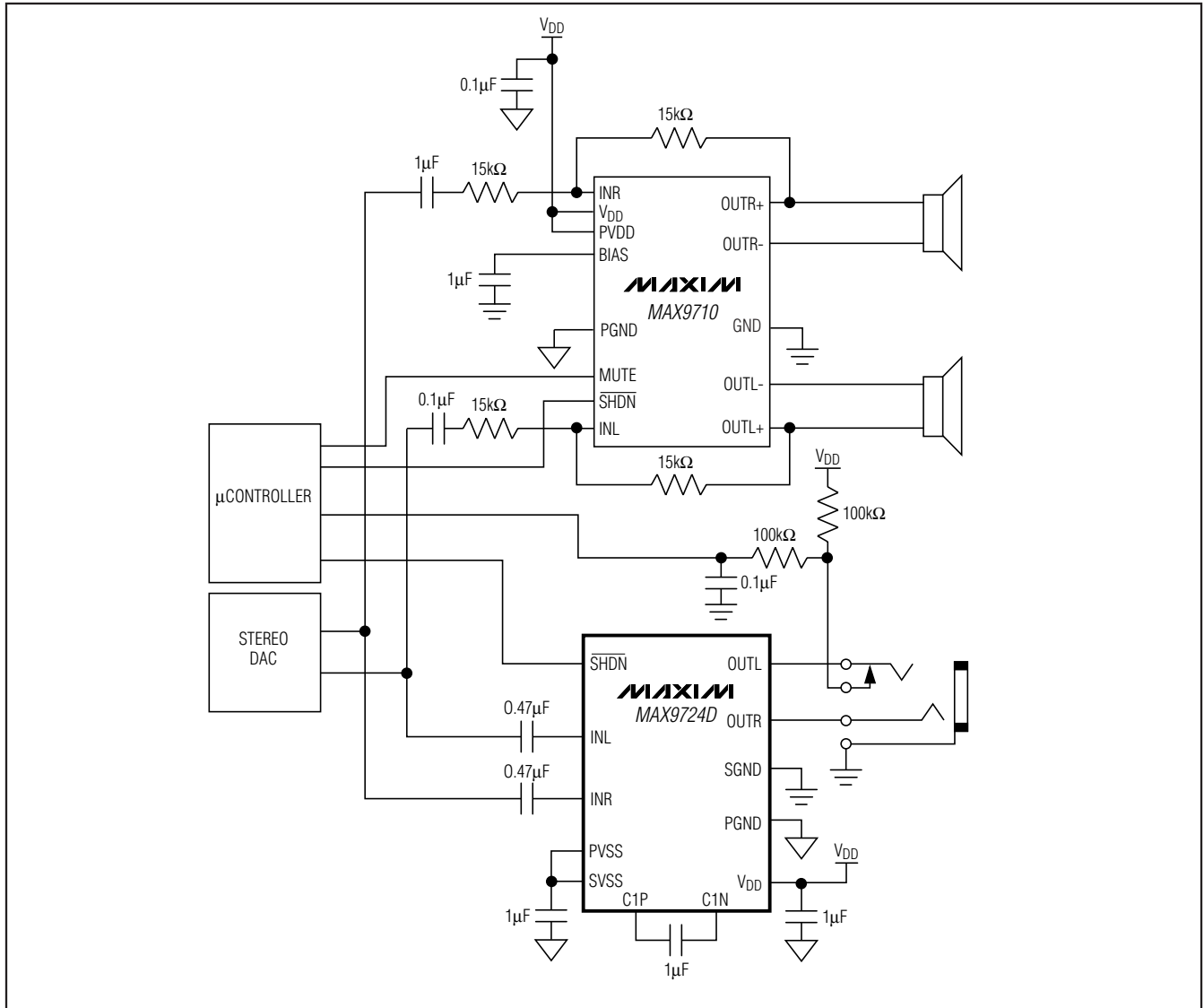

Figure 6. Frequency Response of Active Filter of Figure 4

# Low RF Susceptibility DirectDrive Stereo Head- phone Amplifier with 1.8V Compatible Shutdown

System Diagram

MAX9724C/MAX9724D



# Low RF Susceptibility DirectDrive Stereo Headphone Amplifier with 1.8V Compatible Shutdown

## Functional Diagram/Typical Operating Circuits

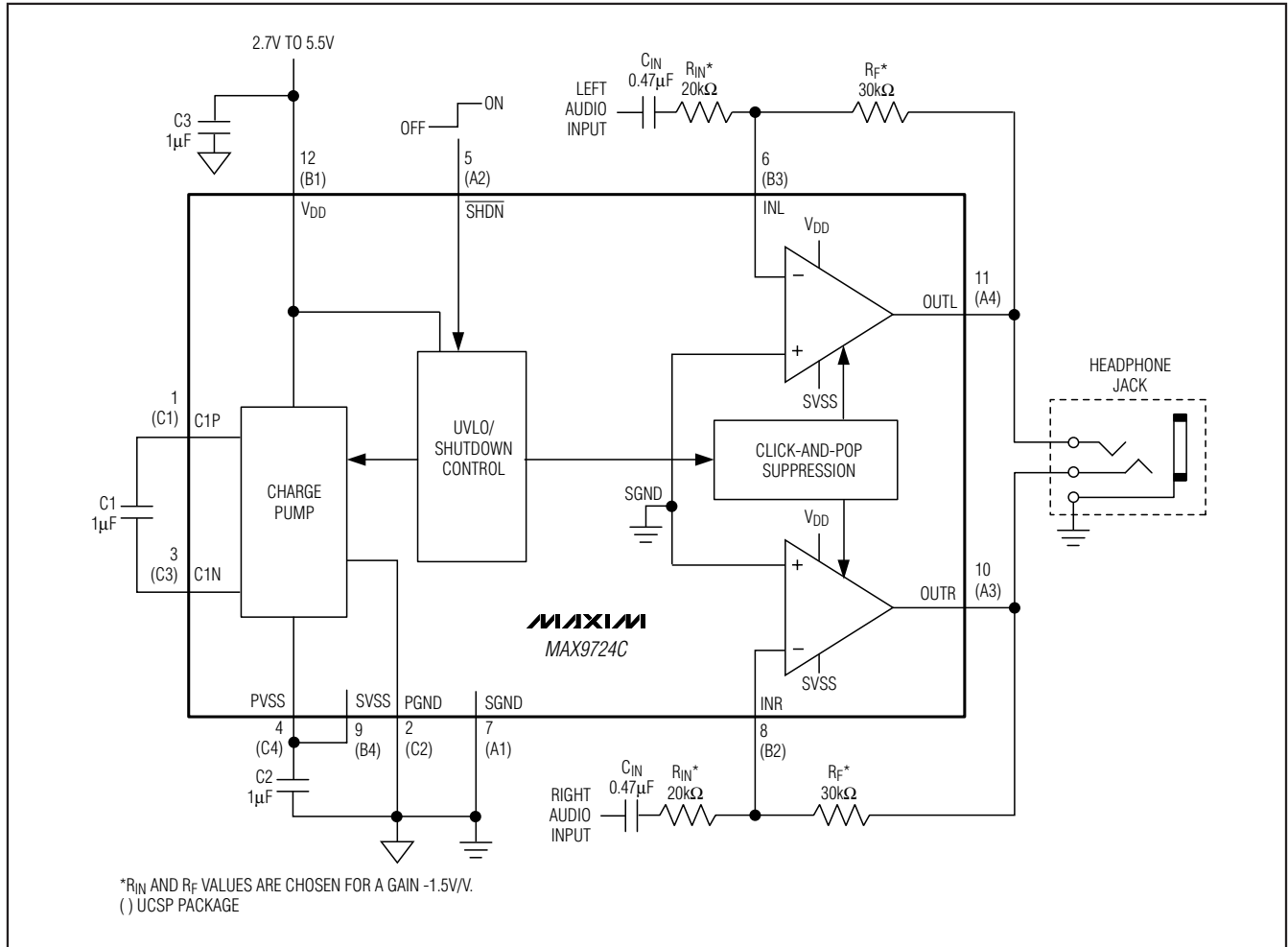



# Low RF Susceptibility DirectDrive Stereo Headphone Amplifier with 1.8V Compatible Shutdown

Functional Diagram/Typical Operating Circuits (continued)

MAX9724C/MAX9724D

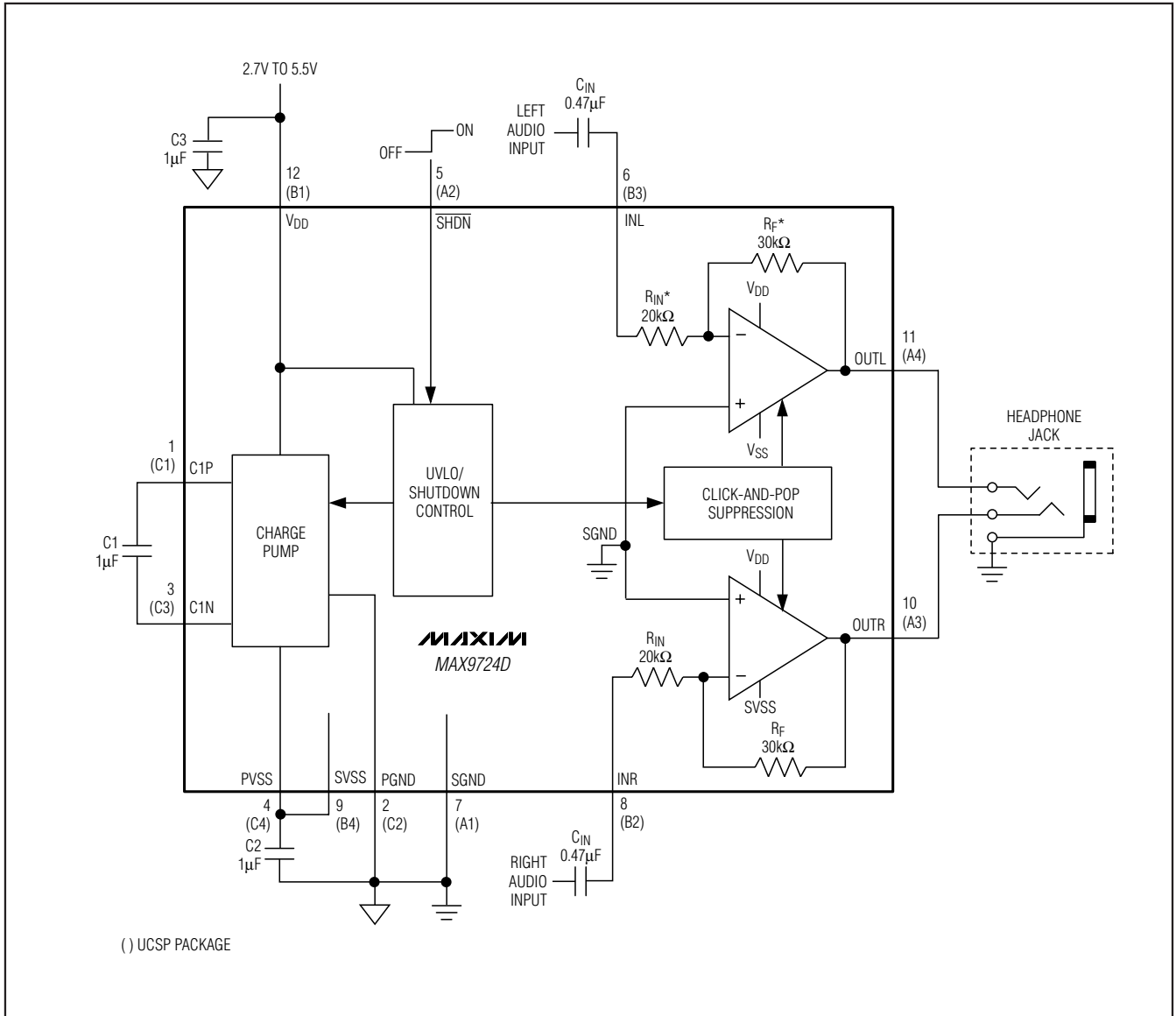

# Low RF Susceptibility DirectDrive Stereo Headphone Amplifier with 1.8V Compatible Shutdown

## Pin Configurations

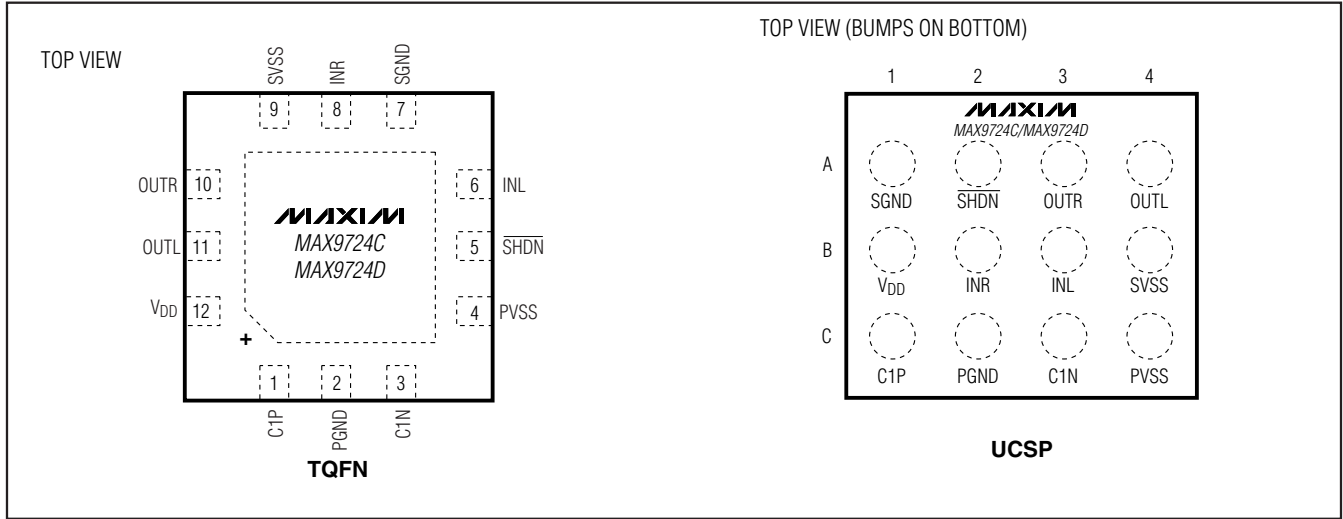

## Chip Information

TRANSISTOR COUNT: 993  
 PROCESS: BiCMOS

# Low RF Susceptibility DirectDrive Stereo Headphone Amplifier with 1.8V Compatible Shutdown

## Package Information

(The package drawing(s) in this data sheet may not reflect the most current specifications. For the latest package outline information go to [www.maxim-ic.com/packages](http://www.maxim-ic.com/packages).)

PACKAGE TYPE	PACKAGE CODE	DOCUMENT NO.
12 UCSP	B12-1	<a href="#">21-0104</a>
12 TQFN-EP	T1233-1	<a href="#">21-0136</a>

**MAX9724C/MAX9724D**

Maxim cannot assume responsibility for use of any circuitry other than circuitry entirely embodied in a Maxim product. No circuit patent licenses are implied. Maxim reserves the right to change the circuitry and specifications without notice at any time.

Maxim Integrated Products, 120 San Gabriel Drive, Sunnyvale, CA 94086 408-737-7600 \_\_\_\_\_ 19

Компания «Океан Электроники» предлагает заключение долгосрочных отношений при поставках импортных электронных компонентов на взаимовыгодных условиях!

Наши преимущества:

- Поставка оригинальных импортных электронных компонентов напрямую с производств Америки, Европы и Азии, а так же с крупнейших складов мира;
- Широкая линейка поставок активных и пассивных импортных электронных компонентов (более 30 млн. наименований);
- Поставка сложных, дефицитных, либо снятых с производства позиций;
- Оперативные сроки поставки под заказ (от 5 рабочих дней);
- Экспресс доставка в любую точку России;
- Помощь Конструкторского Отдела и консультации квалифицированных инженеров;
- Техническая поддержка проекта, помощь в подборе аналогов, поставка прототипов;
- Поставка электронных компонентов под контролем ВП;
- Система менеджмента качества сертифицирована по Международному стандарту ISO 9001;
- При необходимости вся продукция военного и аэрокосмического назначения проходит испытания и сертификацию в лаборатории (по согласованию с заказчиком);
- Поставка специализированных компонентов военного и аэрокосмического уровня качества (Xilinx, Altera, Analog Devices, Intersil, Interpoint, Microsemi, Actel, Aeroflex, Peregrine, VPT, Syfer, Eurofarad, Texas Instruments, MS Kennedy, Miteq, Cobham, E2V, MA-COM, Hittite, Mini-Circuits, General Dynamics и др.);

Компания «Океан Электроники» является официальным дистрибьютором и эксклюзивным представителем в России одного из крупнейших производителей разъемов военного и аэрокосмического назначения «JONHON», а так же официальным дистрибьютором и эксклюзивным представителем в России производителя высокотехнологичных и надежных решений для передачи СВЧ сигналов «FORSTAR».



## JONHON

«JONHON» (основан в 1970 г.)

Разъемы специального, военного и аэрокосмического назначения:

(Применяются в военной, авиационной, аэрокосмической, морской, железнодорожной, горно- и нефтедобывающей отраслях промышленности)

«FORSTAR» (основан в 1998 г.)

ВЧ соединители, коаксиальные кабели, кабельные сборки и микроволновые компоненты:

(Применяются в телекоммуникациях гражданского и специального назначения, в средствах связи, РЛС, а так же военной, авиационной и аэрокосмической отраслях промышленности).



Телефон: 8 (812) 309-75-97 (многоканальный)

Факс: 8 (812) 320-03-32

Электронная почта: [ocean@oceanchips.ru](mailto:ocean@oceanchips.ru)

Web: <http://oceanchips.ru/>

Адрес: 198099, г. Санкт-Петербург, ул. Калинина, д. 2, корп. 4, лит. А