

## FEATURES

**Input voltage range: 2.3 V to 5.5 V**

**Maximum load current: 600 mA**

**Low noise**

0.9  $\mu\text{V}$  rms total integrated noise from 100 Hz to 100 kHz

1.6  $\mu\text{V}$  rms total integrated noise from 10 Hz to 100 kHz

**Noise spectral density: 1.5 nV/ $\sqrt{\text{Hz}}$  from 10 kHz to 1 MHz**

**PSRR of 90 dB from 200 Hz to 200 kHz; 58 dB at 1 MHz,**

$V_{\text{OUT}} = 3.3 \text{ V}$ ,  $V_{\text{IN}} = 3.8 \text{ V}$

**Dropout voltage: 120 mV typical at  $V_{\text{OUT}} = 3.3 \text{ V}$ ,  $I_{\text{OUT}} = 600 \text{ mA}$**

**Initial accuracy:  $\pm 0.5\%$**

**Accuracy over line, load, and temperature:  $-2.0\%$  (minimum),**

$+1.5\%$  (maximum), from  $-40^\circ\text{C}$  to  $+85^\circ\text{C}$

**Quiescent current,  $I_{\text{GND}} = 4 \text{ mA}$  at no load**

**Low shutdown current: 0.2  $\mu\text{A}$**

**Stable with a 10  $\mu\text{F}$  ceramic output capacitor**

**Adjustable and fixed output voltage options: 1.2 V, 1.8 V, 2.5 V, 2.8 V, 3.0 V, 3.3 V (16 standard voltages between 1.2 V and 3.3 V available)**

**8-lead LFCSP and 8-lead SOIC packages**

**Precision enable**

**Supported by [ADIsimPower](#) tool**

## APPLICATIONS

**Regulation to noise sensitive applications: PLLs, VCOs, and PLLs with integrated VCOs**

**Communications and infrastructure**

**Backhaul and microwave links**

## GENERAL DESCRIPTION

The [ADM7154](#) is a linear regulator that operates from 2.3 V to 5.5 V and provides up to 600 mA of load current. Using an advanced proprietary architecture, it provides high power supply rejection and ultralow noise, achieving excellent line and load transient response with only a 10  $\mu\text{F}$  ceramic output capacitor.

There are 16 standard output voltages for the [ADM7154](#). The following voltages are available in stock: 1.2 V, 1.8 V, 2.5 V, 2.8 V, 3.0 V, and 3.3 V. Additional voltages are available by special order: 1.3 V, 1.5 V, 1.6 V, 2.0 V, 2.2 V, 2.6 V, 2.7 V, 2.9 V, 3.1 V, and 3.2 V.

The [ADM7154](#) regulator typical output noise is 0.9  $\mu\text{V}$  rms from 100 Hz to 100 kHz for fixed output voltage options and 1.5 nV/ $\sqrt{\text{Hz}}$  for noise spectral density from 10 kHz to 1 MHz.

## TYPICAL APPLICATION CIRCUIT

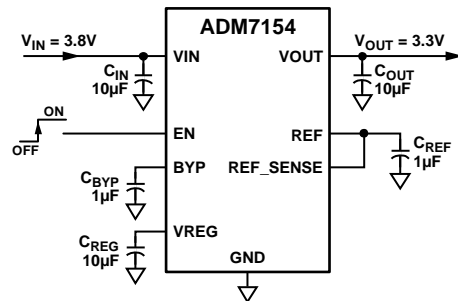

Figure 1. Regulated 3.3 V Output from 3.8 V Input

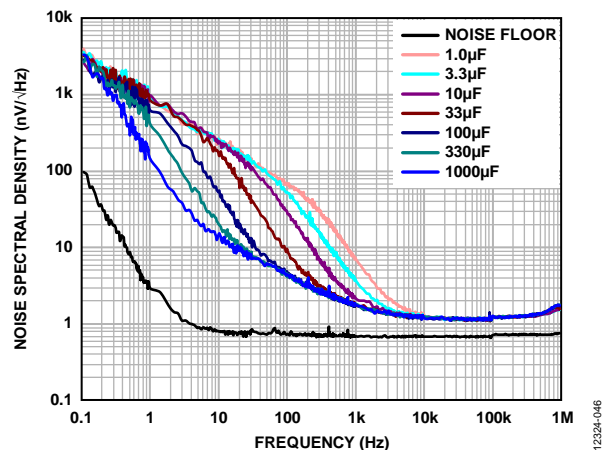

Figure 2. Noise Spectral Density for Different Values of  $C_{\text{BYP}}$

The [ADM7154](#) is available in 8-lead, 3 mm  $\times$  3 mm LFCSP and 8-lead SOIC packages, making it not only a very compact solution, but also providing excellent thermal performance for applications requiring up to 600 mA of load current in a small, low profile footprint.

Table 1. Related Devices

| Model                      | Input Voltage  | Output Current | Fixed/Adj <sup>1</sup> | Package      |
|----------------------------|----------------|----------------|------------------------|--------------|
| <a href="#">ADM7150ACP</a> | 4.5 V to 16 V  | 800 mA         | Fixed                  | 8-Lead LFCSP |
| <a href="#">ADM7150ARD</a> | 4.5 V to 16 V  | 800 mA         | Fixed                  | 8-Lead SOIC  |
| <a href="#">ADM7151ACP</a> | 4.5 V to 16 V  | 800 mA         | Adj                    | 8-Lead LFCSP |
| <a href="#">ADM7151ARD</a> | 4.5 V to 16 V  | 800 mA         | Adj                    | 8-Lead SOIC  |
| <a href="#">ADM7155ACP</a> | 2.3 V to 5.5 V | 600 mA         | Adj                    | 8-Lead LFCSP |
| <a href="#">ADM7155ARD</a> | 2.3 V to 5.5 V | 600 mA         | Adj                    | 8-Lead SOIC  |

<sup>1</sup> Adj means adjustable.

## TABLE OF CONTENTS

|  |    |  |    |
|--|----|--|----|
| Features .....                                     | 1  | Applications Information .....                     | 15 |
| Applications.....                                  | 1  | ADIsimPower Design Tool .....                      | 15 |
| Typical Application Circuit .....                  | 1  | Capacitor Selection .....                          | 15 |
| General Description .....                          | 1  | Undervoltage Lockout (UVLO) .....                  | 16 |
| Revision History .....                             | 2  | Programmable Precision Enable .....                | 17 |
| Specifications.....                                | 3  | Start-Up Time .....                                | 17 |
| Absolute Maximum Ratings.....                      | 5  | REF, BYP, and VREG Pins.....                       | 18 |
| Thermal Data .....                                 | 5  | Current-Limit and Thermal Overload Protection..... | 18 |
| Thermal Resistance .....                           | 5  | Thermal Considerations.....                        | 18 |
| ESD Caution.....                                   | 5  | PCB Layout Considerations.....                     | 21 |
| Pin Configurations and Function Descriptions ..... | 6  | Outline Dimensions .....                           | 22 |
| Typical Performance Characteristics .....          | 7  | Ordering Guide .....                               | 23 |
| Theory of Operation .....                          | 14 |  |    |

## REVISION HISTORY

### 8/2016—Rev. A to Rev. B

|  |    |
|--|----|
| Changes to Programmable Precision Enable Section and Figure 52 ..... | 17 |
|--|----|

### 12/2014—Rev. 0 to Rev. A

|  |    |
|--|----|
| Changes to Figure 35 to Figure 40..... | 12 |
| Changes to Figure 44.....              | 15 |

### 10/2014—Revision 0: Initial Version

## SPECIFICATIONS

$V_{IN} = V_{OUT} + 0.5\text{ V}$  or  $2.3\text{ V}$ , whichever is greater;  $EN = V_{IN}$ ;  $I_{LOAD} = 10\text{ mA}$ ;  $C_{IN} = C_{OUT} = C_{REG} = 10\text{ }\mu\text{F}$ ;  $C_{REF} = C_{BYP} = 1\text{ }\mu\text{F}$ ;  $T_A = 25^\circ\text{C}$  for typical specifications;  $T_J = -40^\circ\text{C}$  to  $+125^\circ\text{C}$  for minimum/maximum specifications, unless otherwise noted.

Table 2.

| Parameter                            | Symbol                          | Test Conditions/Comments   | Min                  | Typ                  | Max                  | Unit                                   |
|--------------------------------------|---------------------------------|--|----------------------|----------------------|----------------------|--|
| INPUT VOLTAGE RANGE                  | $V_{IN}$                        |  | 2.3                  |                      | 5.5                  | V                                      |
| LOAD CURRENT                         | $I_{LOAD}$                      |  |                      |                      | 600                  | mA                                     |
| OPERATING SUPPLY CURRENT             | $I_{GND}$                       | $I_{LOAD} = 0\text{ }\mu\text{A}$<br>$I_{LOAD} = 600\text{ mA}$  |                      | 4.0<br>6.5           | 7.0<br>10            | mA<br>mA                               |
| SHUTDOWN CURRENT                     | $I_{IN\_SD}$                    | $EN = GND$   |                      | 0.2                  | 2                    | $\mu\text{A}$                          |
| NOISE                                |                                 |  |                      |                      |                      |  |
| Output Noise                         | $OUT_{NOISE}$                   | 10 Hz to 100 kHz, $V_{OUT} = 1.2\text{ V}$ to $3.3\text{ V}$<br>100 Hz to 100 kHz, $V_{OUT} = 1.2\text{ V}$ to $3.3\text{ V}$  |                      | 1.6<br>0.9           |                      | $\mu\text{V rms}$<br>$\mu\text{V rms}$ |
| Noise Spectral Density               | $OUT_{NSD}$                     | 10 kHz to 1 MHz, $V_{OUT} = 1.2\text{ V}$ to $3.3\text{ V}$  |                      | 1.5                  |                      | nV/ $\sqrt{\text{Hz}}$                 |
| POWER SUPPLY REJECTION RATIO         | PSRR                            | 200 Hz to 200 kHz, $V_{IN} = 3.8\text{ V}$ , $V_{OUT} = 3.3\text{ V}$ ,<br>$I_{LOAD} = 400\text{ mA}$<br>1 MHz, $V_{IN} = 3.8\text{ V}$ , $V_{OUT} = 3.3\text{ V}$ , $I_{LOAD} = 400\text{ mA}$<br>200 Hz to 200 kHz, $V_{IN} = 2.3\text{ V}$ , $V_{OUT} = 1.8\text{ V}$ ,<br>$I_{LOAD} = 400\text{ mA}$<br>1 MHz, $V_{IN} = 2.3\text{ V}$ , $V_{OUT} = 1.8\text{ V}$ , $I_{LOAD} = 400\text{ mA}$ |                      | 90<br>58<br>90<br>63 |                      | dB<br>dB<br>dB<br>dB                   |
| OUTPUT VOLTAGE ACCURACY              |                                 |  |                      |                      |                      |  |
| Initial Accuracy                     | $V_{OUT}$                       | $V_{OUT} = V_{REF}$<br>$I_{LOAD} = 10\text{ mA}$ , $T_J = +25^\circ\text{C}$<br>$1\text{ mA} < I_{LOAD} < 600\text{ mA}$ , $T_J = -40^\circ\text{C}$ to $+85^\circ\text{C}$<br>$1\text{ mA} < I_{LOAD} < 600\text{ mA}$  | -0.5<br>-2.0<br>-2.0 |                      | +0.5<br>+1.5<br>+2.0 | %<br>%<br>%                            |
| REGULATION                           |                                 |  |                      |                      |                      |  |
| Line                                 | $\Delta V_{OUT}/\Delta V_{IN}$  | $V_{IN} = V_{OUT} + 0.5\text{ V}$ or $2.3\text{ V}$ , whichever is greater,<br>to $5.5\text{ V}$   | -0.02                |                      | +0.02                | %/V                                    |
| Load <sup>1</sup>                    | $\Delta V_{OUT}/\Delta I_{OUT}$ | $I_{OUT} = 1\text{ mA}$ to $600\text{ mA}$   |                      | 0.3                  | 1.6                  | %/A                                    |
| CURRENT-LIMIT THRESHOLD <sup>2</sup> | $I_{LIMIT}$                     |  |                      |                      |                      |  |
| $V_{REF}$                            |                                 |  |                      | 22                   |                      | mA                                     |
| $V_{OUT}$                            |                                 |  | 700                  | 960                  | 1200                 | mA                                     |
| DROPOUT VOLTAGE <sup>3</sup>         | $V_{DROPOUT}$                   | $I_{OUT} = 400\text{ mA}$ , $V_{OUT} = 3.3\text{ V}$<br>$I_{OUT} = 600\text{ mA}$ , $V_{OUT} = 3.3\text{ V}$   |                      | 80<br>120            | 130<br>210           | mV<br>mV                               |
| PULL-DOWN RESISTANCE                 |                                 |  |                      |                      |                      |  |
| $V_{OUT}$                            | $V_{OUT\_PULL}$                 | $EN = 0\text{ V}$ , $V_{OUT} = 1\text{ V}$ , $V_{IN} = 5.5\text{ V}$   |                      | 550                  |                      | $\Omega$                               |
| REG                                  | $V_{REG\_PULL}$                 | $EN = 0\text{ V}$ , $V_{REG} = 1\text{ V}$ , $V_{IN} = 5.5\text{ V}$   |                      | 33                   |                      | k $\Omega$                             |
| REF                                  | $V_{REF\_PULL}$                 | $EN = 0\text{ V}$ , $V_{REF} = 1\text{ V}$ , $V_{IN} = 5.5\text{ V}$   |                      | 620                  |                      | $\Omega$                               |
| BYP                                  | $V_{BYP\_PULL}$                 | $EN = 0\text{ V}$ , $V_{BYP} = 1\text{ V}$ , $V_{IN} = 5.5\text{ V}$   |                      | 400                  |                      | $\Omega$                               |
| START-UP TIME <sup>4</sup>           |                                 |  |                      |                      |                      |  |
| $V_{OUT}$                            | $t_{STARTUP}$                   | $V_{OUT} = 3.3\text{ V}$   |                      | 1.2                  |                      | ms                                     |
| $V_{REG}$                            | $t_{REG\_STARTUP}$              | $V_{OUT} = 3.3\text{ V}$   |                      | 0.55                 |                      | ms                                     |
| $V_{REF}$                            | $t_{REF\_STARTUP}$              | $V_{OUT} = 3.3\text{ V}$   |                      | 0.44                 |                      | ms                                     |
| THERMAL SHUTDOWN                     |                                 |  |                      |                      |                      |  |
| Threshold                            | $TS_{SD}$                       | $T_J$ rising   |                      | 150                  |                      | $^\circ\text{C}$                       |
| Hysteresis                           | $TS_{SD\_HYS}$                  |  |                      | 15                   |                      | $^\circ\text{C}$                       |
| UNDERVOLTAGE THRESHOLDS              |                                 |  |                      |                      |                      |  |
| Input Voltage                        |                                 |  |                      |                      |                      |  |
| Rising                               | $UVLO_{RISE}$                   |  |                      |                      | 2.29                 | V                                      |
| Falling                              | $UVLO_{FALL}$                   |  | 1.95                 |                      |                      | V                                      |
| Hysteresis                           | $UVLO_{HYS}$                    |  |                      | 200                  |                      | mV                                     |

| Parameter                                | Symbol                    | Test Conditions/Comments        | Min  | Typ  | Max  | Unit |
|--|---------------------------|---------------------------------|------|------|------|------|
| V <sub>REG</sub> THRESHOLDS <sup>5</sup> |                           |                                 |      |      |      |      |
| Rising                                   | V <sub>REG_UVLORISE</sub> |                                 |      |      | 1.94 | V    |
| Falling                                  | V <sub>REG_UVLOFALL</sub> |                                 | 1.60 |      |      | V    |
| Hysteresis                               | V <sub>REG_UVLOHYS</sub>  |                                 |      | 185  |      | mV   |
| PRECISION EN INPUT                       |                           | 2.3 V ≤ V <sub>IN</sub> ≤ 5.5 V |      |      |      |      |
| Logic High                               | EN <sub>HIGH</sub>        |                                 | 1.13 | 1.22 | 1.31 | V    |
| Logic Low                                | EN <sub>LOW</sub>         |                                 | 1.05 | 1.13 | 1.22 | V    |
| Logic Hysteresis                         | EN <sub>HYS</sub>         |                                 |      | 90   |      | mV   |
| Leakage Current                          | I <sub>EN_LKG</sub>       | EN = V <sub>IN</sub> or GND     |      | 0.01 | 1    | μA   |

<sup>1</sup> Based on an endpoint calculation using 1 mA and 600 mA loads.

<sup>2</sup> Current-limit threshold is defined as the current at which the output voltage drops to 90% of the specified typical value. For example, the current limit for a 3.0 V output voltage is defined as the current that causes the output voltage to drop to 90% of 3.0 V, or 2.7 V.

<sup>3</sup> Dropout voltage is defined as the input-to-output voltage differential when the input voltage is set to the nominal output voltage. Dropout applies only for output voltages above 2.3 V.

<sup>4</sup> Start-up time is defined as the time between the rising edge of V<sub>EN</sub> to V<sub>OUT</sub>, V<sub>REG</sub>, or V<sub>REF</sub> being at 90% of the nominal value.

<sup>5</sup> The output voltage is disabled until the V<sub>REG</sub> UVLO rise threshold is crossed. The V<sub>REG</sub> output is disabled until the input voltage UVLO rising threshold is crossed.

**Table 3. Input and Output Capacitors, Recommended Specifications**

| Parameter  | Symbol           | Test Conditions/Comments         | Min   | Typ | Max | Unit |
|--|------------------|----------------------------------|-------|-----|-----|------|
| MINIMUM CAPACITANCE  |                  |                                  |       |     |     |      |
| Input <sup>1</sup>   | C <sub>IN</sub>  | T <sub>A</sub> = -40°C to +125°C | 7.0   |     |     | μF   |
| Regulator <sup>1</sup>   | C <sub>REG</sub> | T <sub>A</sub> = -40°C to +125°C | 7.0   |     |     | μF   |
| Output <sup>1</sup>  | C <sub>OUT</sub> | T <sub>A</sub> = -40°C to +125°C | 7.0   |     |     | μF   |
| Bypass   | C <sub>BYP</sub> | T <sub>A</sub> = -40°C to +125°C | 0.1   |     |     | μF   |
| Reference  | C <sub>REF</sub> | T <sub>A</sub> = -40°C to +125°C | 0.7   |     |     | μF   |
| CAPACITOR ESR  |                  |                                  |       |     |     |      |
| C <sub>REG</sub> , C <sub>OUT</sub> , C <sub>IN</sub> , C <sub>REF</sub> | R <sub>ESR</sub> | T <sub>A</sub> = -40°C to +125°C | 0.001 |     | 0.2 | Ω    |
| C <sub>BYP</sub>   | R <sub>ESR</sub> | T <sub>A</sub> = -40°C to +125°C | 0.001 |     | 2.0 | Ω    |

<sup>1</sup> The minimum input, regulator, and output capacitances must be greater than 7.0 μF over the full range of operating conditions. The full range of operating conditions in the application must be considered during device selection to ensure that the minimum capacitance specification is met. X7R and X5R type capacitors are recommended; Y5V and Z5U capacitors are not recommended for use with any LDO.

## ABSOLUTE MAXIMUM RATINGS

Table 4.

| Parameter                           | Rating   |
|-------------------------------------|--|
| VIN to GND                          | −0.3 V to +7 V                                 |
| VREG to GND                         | −0.3 V to VIN, or +4 V<br>(whichever is less)  |
| VOUT to GND                         | −0.3 V to VREG, or +4 V<br>(whichever is less) |
| BYP to VOUT                         | ±0.3 V   |
| EN to GND                           | −0.3 V to +7 V                                 |
| BYP to GND                          | −0.3 V to VREG, or +4 V<br>(whichever is less) |
| REF to GND                          | −0.3 V to VREG, or +4 V<br>(whichever is less) |
| REF_SENSE to GND                    | −0.3 V to +4 V                                 |
| Storage Temperature Range           | −65°C to +150°C                                |
| Junction Temperature                | 150°C  |
| Operating Ambient Temperature Range | −40°C to +125°C                                |
| Soldering Conditions                | JEDEC J-STD-020                                |

Stresses at or above those listed under Absolute Maximum Ratings may cause permanent damage to the product. This is a stress rating only; functional operation of the product at these or any other conditions above those indicated in the operational section of this specification is not implied. Operation beyond the maximum operating conditions for extended periods may affect product reliability.

### THERMAL DATA

Absolute maximum ratings apply individually only, not in combination. The ADM7154 can be damaged when the junction temperature limits are exceeded. Monitoring ambient temperature does not guarantee that  $T_J$  is within the specified temperature limits. In applications with high power dissipation and poor thermal resistance, the maximum ambient temperature may need to be derated.

In applications with moderate power dissipation and low printed circuit board (PCB) thermal resistance, the maximum ambient temperature can exceed the maximum limit provided that the junction temperature is within specification limits. The junction temperature ( $T_J$ ) of the device is dependent on the ambient temperature ( $T_A$ ), the power dissipation of the device ( $P_D$ ), and the junction-to-ambient thermal resistance of the package ( $\theta_{JA}$ ).

Maximum junction temperature ( $T_J$ ) is calculated from the ambient temperature ( $T_A$ ) and power dissipation ( $P_D$ ) using the following formula:

$$T_J = T_A + (P_D \times \theta_{JA})$$

Junction-to-ambient thermal resistance ( $\theta_{JA}$ ) of the package is based on modeling and calculation using a 4-layer PCB. The junction-to-ambient thermal resistance is highly dependent on the application and PCB layout. In applications where high maximum power dissipation exists, close attention to thermal PCB design is required. The value of  $\theta_{JA}$  can vary, depending on PCB material, layout, and environmental conditions. The specified values of  $\theta_{JA}$  are based on a 4-layer, 4 in. × 3 in. circuit board. See JESD51-7 and JESD51-9 for detailed information on the board construction.

$\Psi_{JB}$  is the junction-to-board thermal characterization parameter with units of °C/W.  $\Psi_{JB}$  of the package is based on modeling and calculation using a 4-layer PCB. JESD51-12, *Guidelines for Reporting and Using Electronic Package Thermal Information*, states that thermal characterization parameters are not the same as thermal resistances.  $\Psi_{JB}$  measures the component power flowing through multiple thermal paths rather than a single path as in thermal resistance,  $\theta_{JB}$ . Therefore,  $\Psi_{JB}$  thermal paths include convection from the top of the package as well as radiation from the package, factors that make  $\Psi_{JB}$  more useful in real-world applications. Maximum junction temperature ( $T_J$ ) is calculated from the PCB temperature ( $T_B$ ) and power dissipation ( $P_D$ ) using the formula

$$T_J = T_B + (P_D \times \Psi_{JB})$$

See JESD51-8 and JESD51-12 for more detailed information about  $\Psi_{JB}$ .

### THERMAL RESISTANCE

$\theta_{JA}$ ,  $\theta_{JC}$ , and  $\Psi_{JB}$  are specified for the worst case conditions, that is, a device soldered in a circuit board for surface-mount packages.

Table 5. Thermal Resistance

| Package Type | $\theta_{JA}$ | $\theta_{JC}$ | $\Psi_{JB}$ | Unit |
|--------------|---------------|---------------|-------------|------|
| 8-Lead LFCSP | 36.7          | 23.5          | 13.3        | °C/W |
| 8-Lead SOIC  | 36.9          | 27.1          | 18.6        | °C/W |

### ESD CAUTION



**ESD (electrostatic discharge) sensitive device.** Charged devices and circuit boards can discharge without detection. Although this product features patented or proprietary protection circuitry, damage may occur on devices subjected to high energy ESD. Therefore, proper ESD precautions should be taken to avoid performance degradation or loss of functionality.

## PIN CONFIGURATIONS AND FUNCTION DESCRIPTIONS

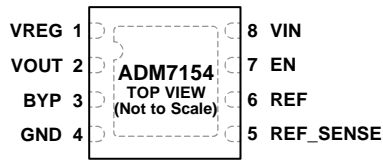

**NOTES**  
 1. THE EXPOSED PAD IS LOCATED ON THE BOTTOM OF THE PACKAGE. THE EXPOSED PAD ENHANCES THERMAL PERFORMANCE, AND IT IS ELECTRICALLY CONNECTED TO GND INSIDE THE PACKAGE. CONNECT THE EP TO THE GROUND PLANE ON THE BOARD TO ENSURE PROPER OPERATION.

12324-003

Figure 3. 8-Lead LFCSP Pin Configuration

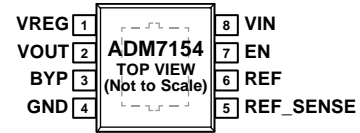

**NOTES**  
 1. THE EXPOSED PAD IS LOCATED ON THE BOTTOM OF THE PACKAGE. THE EXPOSED PAD ENHANCES THERMAL PERFORMANCE, AND IT IS ELECTRICALLY CONNECTED TO GND INSIDE THE PACKAGE. CONNECT THE EP TO THE GROUND PLANE ON THE BOARD TO ENSURE PROPER OPERATION.

12324-004

Figure 4. 8-Lead SOIC Pin Configuration

Table 6. Pin Function Descriptions

| Pin No. | Mnemonic  | Description  |
|---------|-----------|--|
| 1       | VREG      | Regulated Input Supply Voltage to LDO Amplifier. Bypass VREG to GND with a 10 $\mu$ F or greater capacitor.  |
| 2       | VOUT      | Regulated Output Voltage. Bypass VOUT to GND with a 10 $\mu$ F or greater capacitor.   |
| 3       | BYP       | Low Noise Bypass Capacitor. Connect a 1 $\mu$ F capacitor from the BYP pin to GND to reduce noise. Do not connect a load to ground.  |
| 4       | GND       | Ground Connection.   |
| 5       | REF_SENSE | Reference Sense. Connect Pin 5 to the REF pin. Do not connect Pin 5 to VOUT or GND.  |
| 6       | REF       | Low Noise Reference Voltage Output. Bypass REF to GND with a 1 $\mu$ F capacitor. Short REF_SENSE to REF for fixed output voltages. Do not connect a load to ground.   |
| 7       | EN        | Enable. Drive EN high to turn on the regulator; drive EN low to turn off the regulator. For automatic startup, connect EN to VIN.  |
| 8       | VIN<br>EP | Regulator Input Supply Voltage. Bypass VIN to GND with a 10 $\mu$ F or greater capacitor.<br>Exposed Pad. The exposed pad is located on the bottom of the package. The exposed pad enhances thermal performance, and it is electrically connected to GND inside the package. Connect the EP to the ground plane on the board to ensure proper operation. |

# TYPICAL PERFORMANCE CHARACTERISTICS

$V_{IN} = V_{OUT} + 0.5\text{ V}$ , or  $V_{IN} = 2.3\text{ V}$ , whichever is greater;  $V_{EN} = V_{IN}$ ;  $I_{OUT} = 10\text{ mA}$ ;  $C_{IN} = C_{OUT} = C_{REG} = 10\text{ }\mu\text{F}$ ;  $C_{REF} = C_{BYP} = 1\text{ }\mu\text{F}$ ;  $T_A = 25^\circ\text{C}$ , unless otherwise noted.

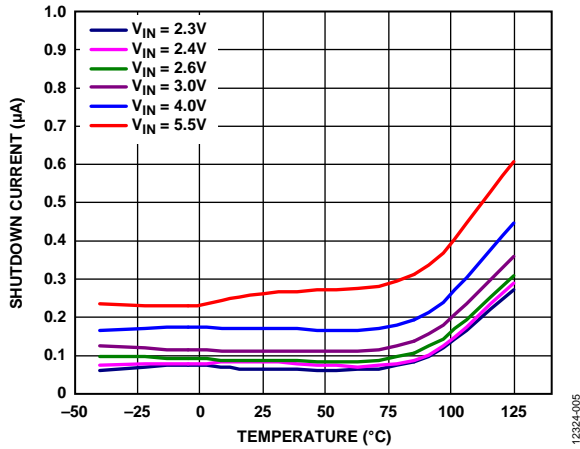

Figure 5. Shutdown Current vs. Temperature at Various Input Voltages,  $V_{OUT} = 1.8\text{ V}$

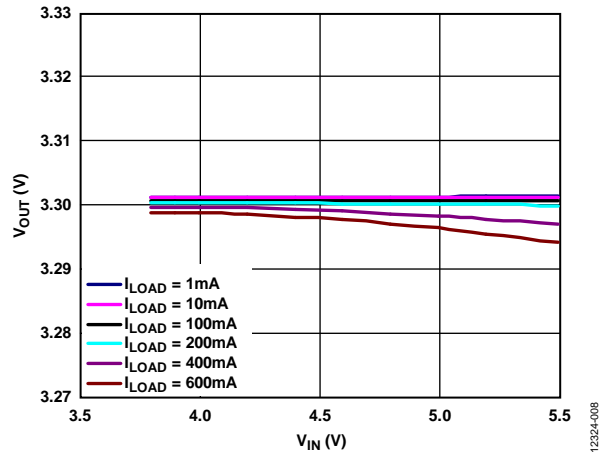

Figure 8. Output Voltage ( $V_{OUT}$ ) vs. Input Voltage ( $V_{IN}$ ) at Various Loads,  $V_{OUT} = 3.3\text{ V}$

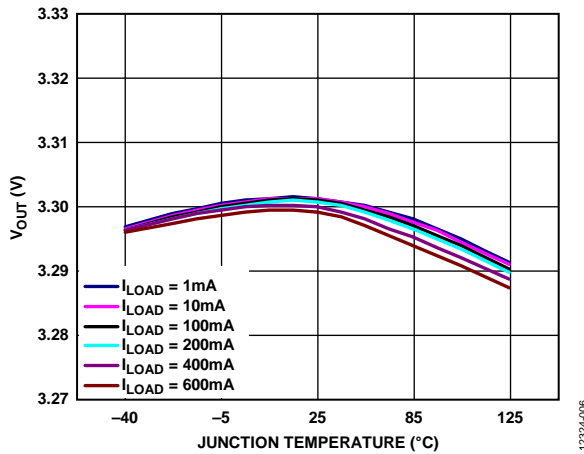

Figure 6. Output Voltage ( $V_{OUT}$ ) vs. Junction Temperature at Various Loads,  $V_{OUT} = 3.3\text{ V}$

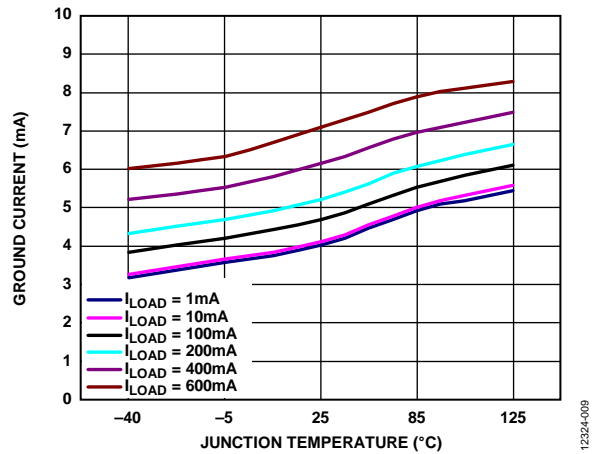

Figure 9. Ground Current vs. Junction Temperature ( $T_J$ ) at Various Loads,  $V_{OUT} = 3.3\text{ V}$

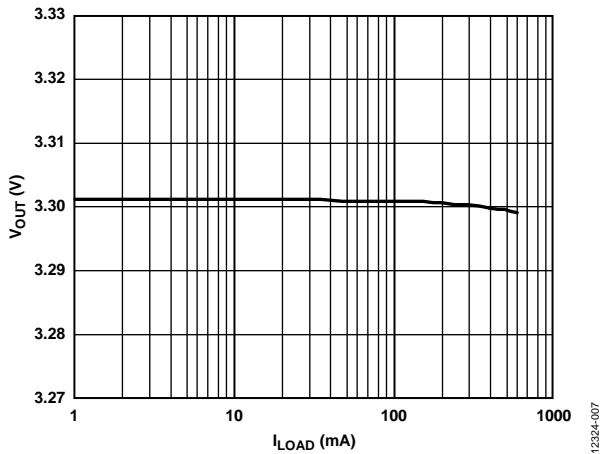

Figure 7. Output Voltage ( $V_{OUT}$ ) vs. Load Current ( $I_{LOAD}$ ),  $V_{OUT} = 3.3\text{ V}$

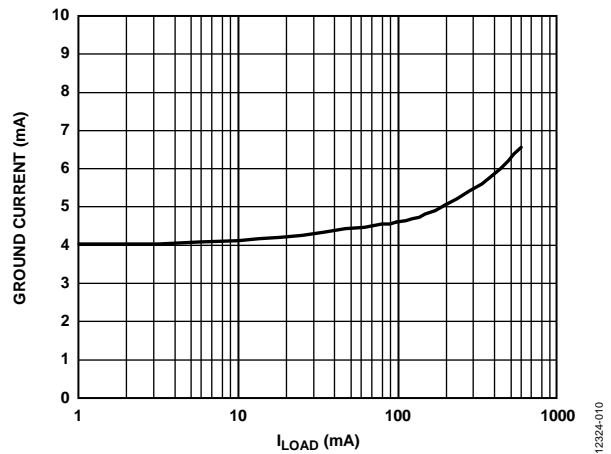

Figure 10. Ground Current vs. Load Current ( $I_{LOAD}$ ),  $V_{OUT} = 3.3\text{ V}$

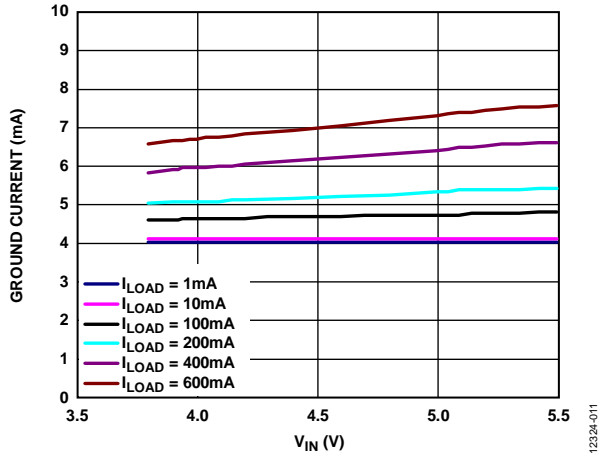

Figure 11. Ground Current vs. Input Voltage ( $V_{IN}$ ) at Various Loads,  $V_{OUT} = 3.3\text{ V}$

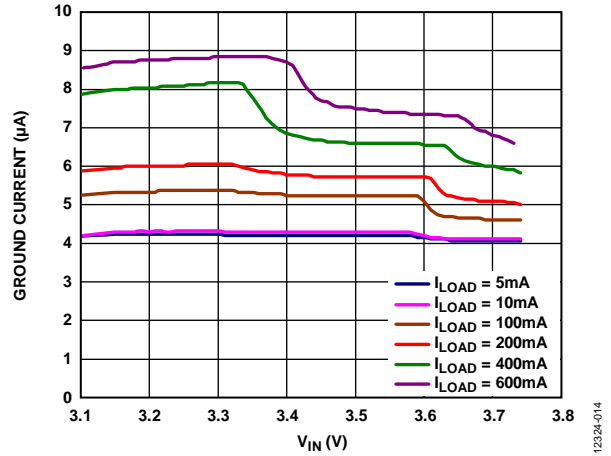

Figure 14. Ground Current vs. Input Voltage ( $V_{IN}$ ) in Dropout,  $V_{OUT} = 3.3\text{ V}$

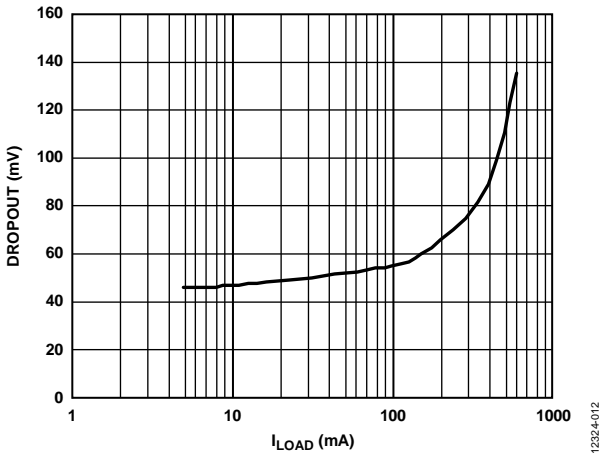

Figure 12. Dropout Voltage vs. Load Current ( $I_{LOAD}$ ),  $V_{OUT} = 3.3\text{ V}$

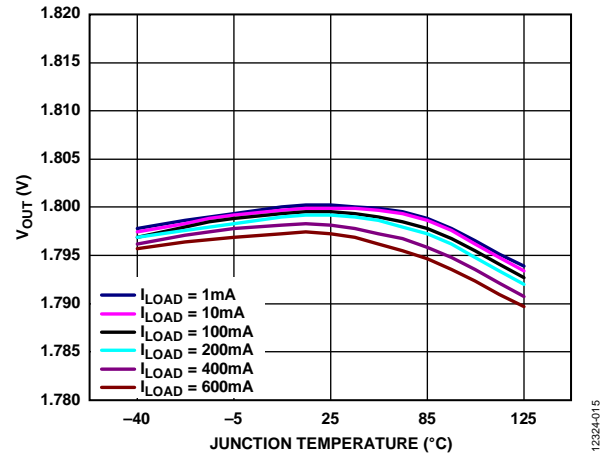

Figure 15. Output Voltage ( $V_{OUT}$ ) vs. Junction Temperature ( $T_j$ ) at Various Loads,  $V_{OUT} = 1.8\text{ V}$

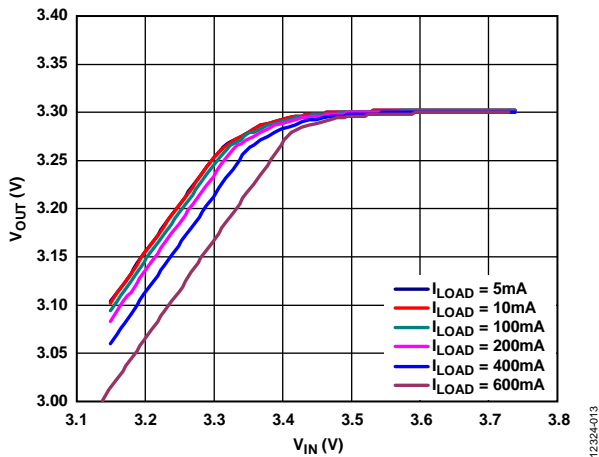

Figure 13. Output Voltage ( $V_{OUT}$ ) vs. Input Voltage ( $V_{IN}$ ) in Dropout,  $V_{OUT} = 3.3\text{ V}$

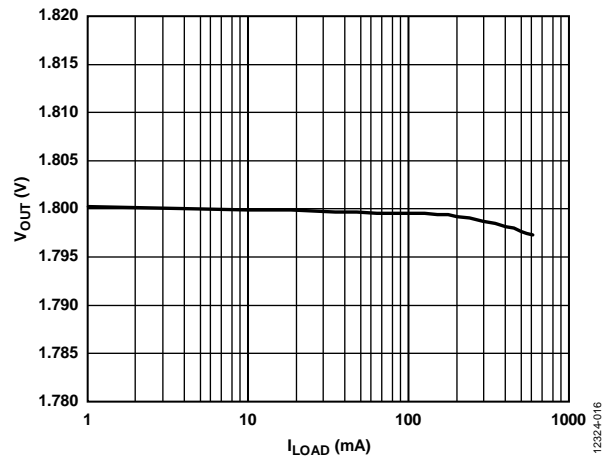

Figure 16. Output Voltage ( $V_{OUT}$ ) vs. Load Current ( $I_{LOAD}$ ),  $V_{OUT} = 1.8\text{ V}$



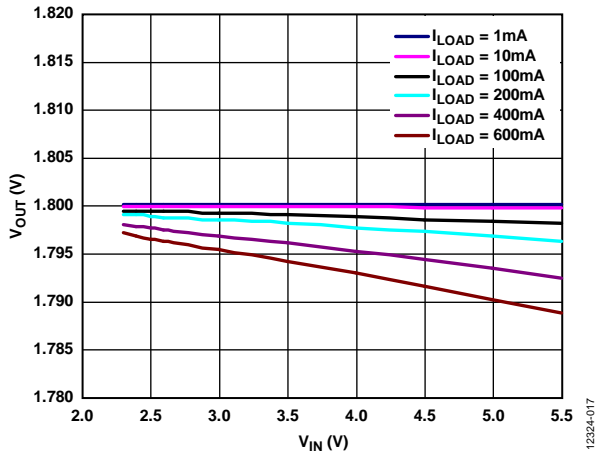

Figure 17. Output Voltage ( $V_{OUT}$ ) vs. Input Voltage ( $V_{IN}$ ) at Various Loads,  $V_{OUT} = 1.8\text{ V}$

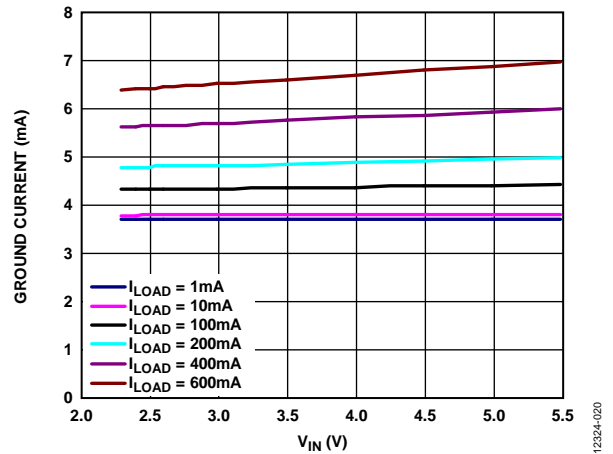

Figure 20. Ground Current vs. Input Voltage ( $V_{IN}$ ) at Different Loads,  $V_{OUT} = 1.8\text{ V}$

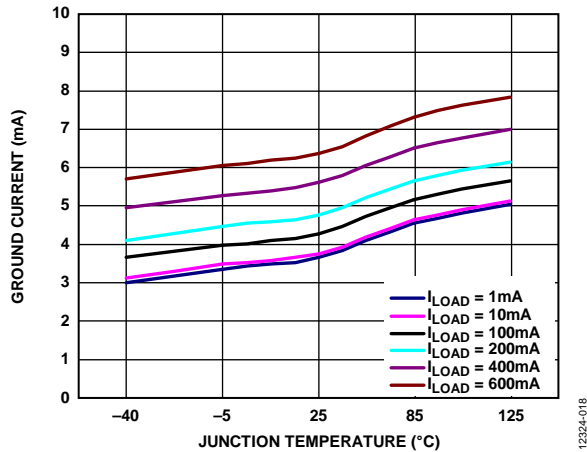

Figure 18. Ground Current vs. Junction Temperature ( $T_J$ ) at Various Loads,  $V_{OUT} = 1.8\text{ V}$

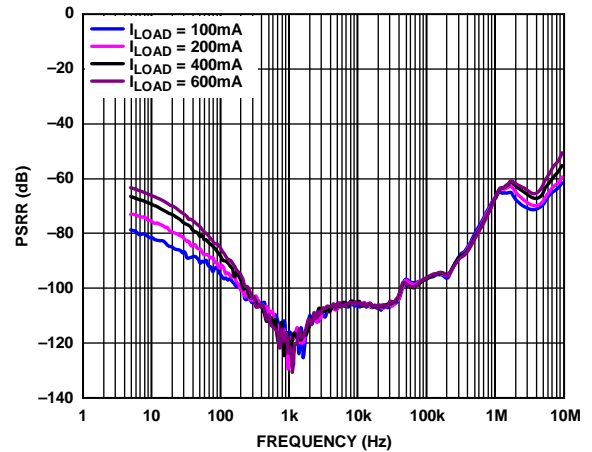

Figure 21. Power Supply Rejection Ratio (PSRR) vs. Frequency at Various Loads,  $V_{OUT} = 3.3\text{ V}$ ,  $V_{IN} = 4.1\text{ V}$

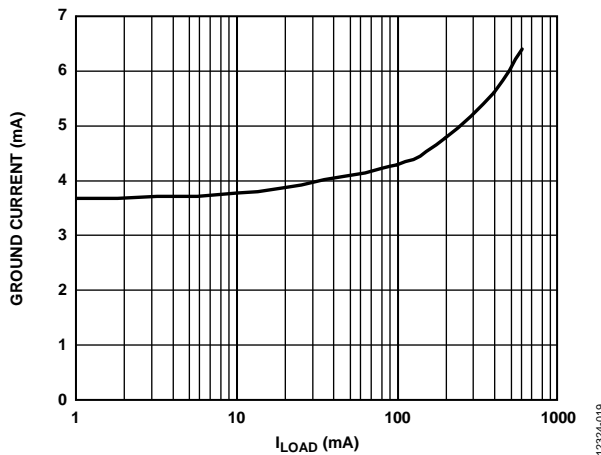

Figure 19. Ground Current vs. Load Current ( $I_{LOAD}$ ),  $V_{OUT} = 1.8\text{ V}$

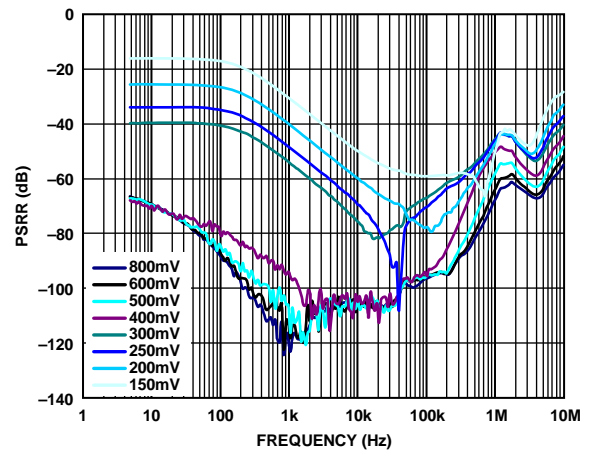

Figure 22. Power Supply Rejection Ratio (PSRR) vs. Frequency at Various Headroom Voltages,  $V_{OUT} = 3.3\text{ V}$ ,  $400\text{ mA Load}$

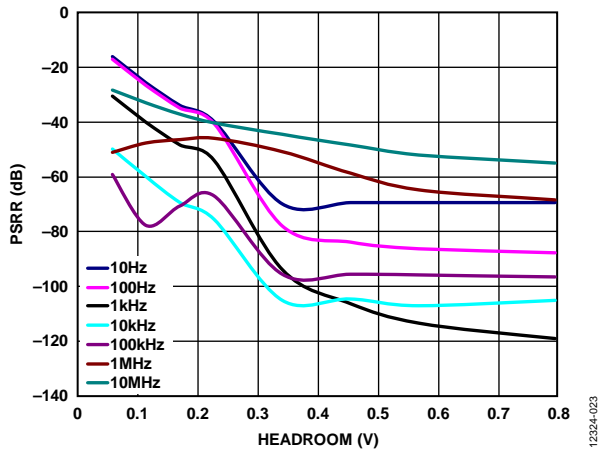

Figure 23. Power Supply Rejection Ratio (PSRR) vs. Headroom Voltage at Different Frequencies,  $V_{OUT} = 3.3\text{ V}$ , 400 mA Load

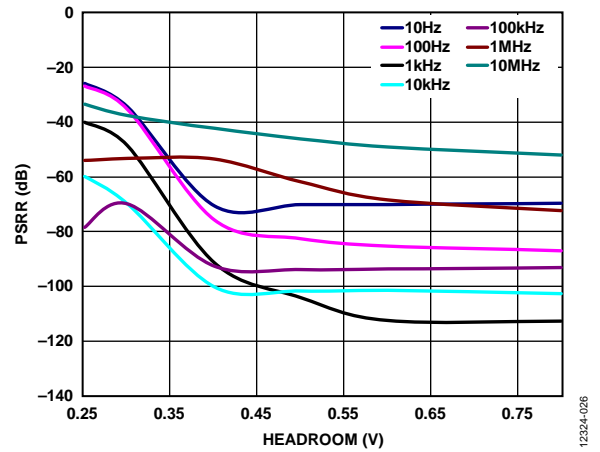

Figure 26. Power Supply Rejection Ratio (PSRR) vs. Headroom Voltage, Different Frequencies,  $V_{OUT} = 1.8\text{ V}$ , 400 mA Load



Figure 24. Power Supply Rejection Ratio (PSRR) vs. Frequency at Various Loads,  $V_{OUT} = 1.8\text{ V}$ ,  $V_{IN} = 2.6\text{ V}$

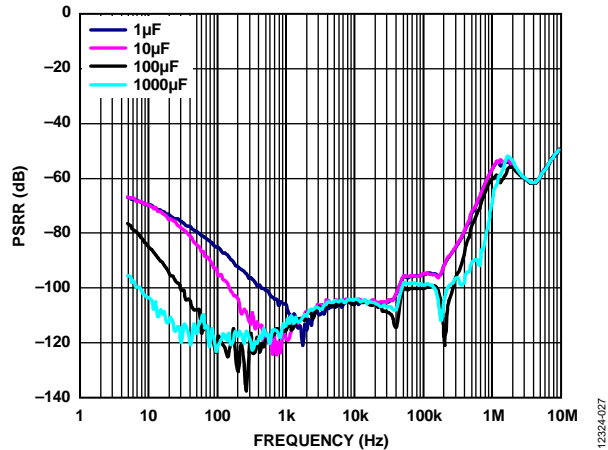

Figure 27. Power Supply Rejection Ratio (PSRR) vs. Frequency, Different  $C_{BYP}$ ,  $V_{OUT} = 3.3\text{ V}$ , 400 mA Load, 500 mV Headroom

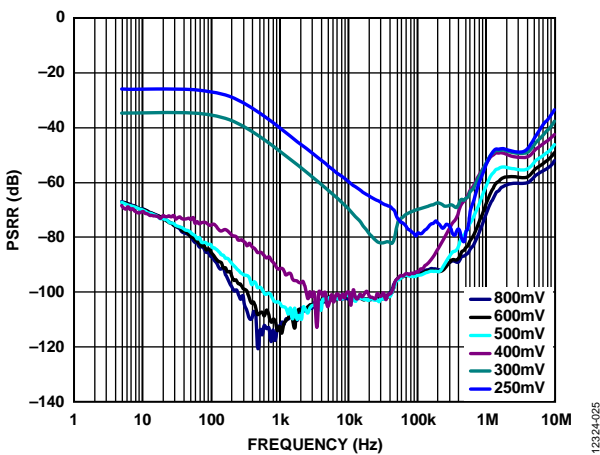

Figure 25. Power Supply Rejection Ratio (PSRR) vs. Frequency at Various Headroom Voltages,  $V_{OUT} = 1.8\text{ V}$ , 400 mA Load

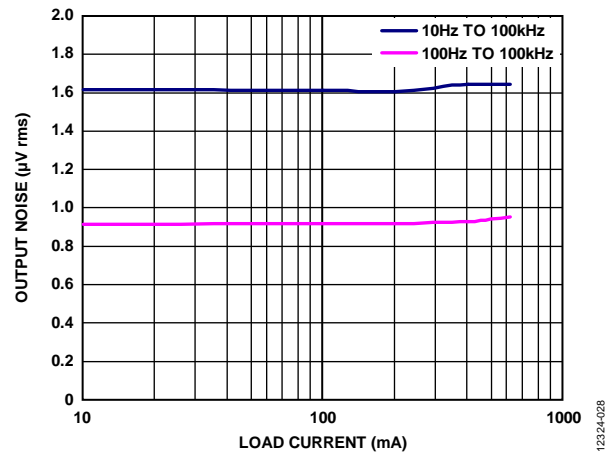

Figure 28. RMS Output Noise vs. Load Current



Figure 29. RMS Output Noise vs. Output Voltage

12324-034



Figure 32. Output Noise Spectral Density, 0.1 Hz to 10 MHz,  $I_{LOAD} = 100\text{ mA}$

12324-032



Figure 30. Output Noise Spectral Density, 10 Hz to 10 MHz,  $I_{LOAD} = 100\text{ mA}$

12324-029



Figure 33. Output Noise Spectral Density at Various Loads, 0.1 Hz to 1 MHz

12324-070



Figure 31. Output Noise Spectral Density, 0.1 Hz to 1 MHz,  $I_{LOAD} = 10\text{ mA}$

12324-030



Figure 34. Output Noise Spectral Density at Various Loads, 10 Hz to 10 MHz

12324-031



Figure 35. Load Transient Response,  $I_{LOAD} = 10\text{ mA to }510\text{ mA}$ ,  $V_{OUT} = 3.3\text{ V}$ ,  $V_{IN} = 3.8\text{ V}$ , CH1 =  $I_{OUT}$ , CH2 =  $V_{OUT}$

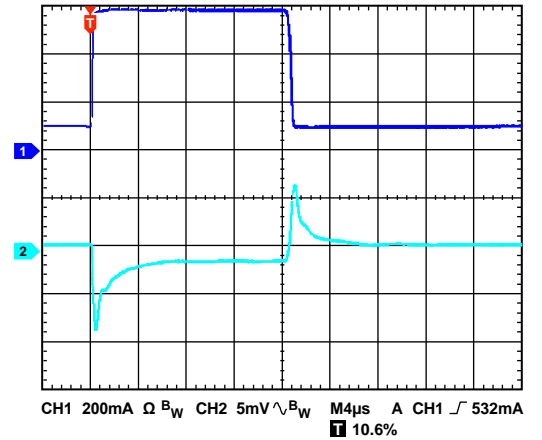

Figure 38. Load Transient Response,  $I_{LOAD} = 100\text{ mA to }600\text{ mA}$ ,  $V_{OUT} = 1.8\text{ V}$ ,  $V_{IN} = 2.3\text{ V}$ , CH1 =  $I_{OUT}$ , CH2 =  $V_{OUT}$



Figure 36. Load Transient Response,  $I_{LOAD} = 100\text{ mA to }600\text{ mA}$ ,  $V_{OUT} = 3.3\text{ V}$ ,  $V_{IN} = 3.8\text{ V}$ , CH1 =  $I_{OUT}$ , CH2 =  $V_{OUT}$

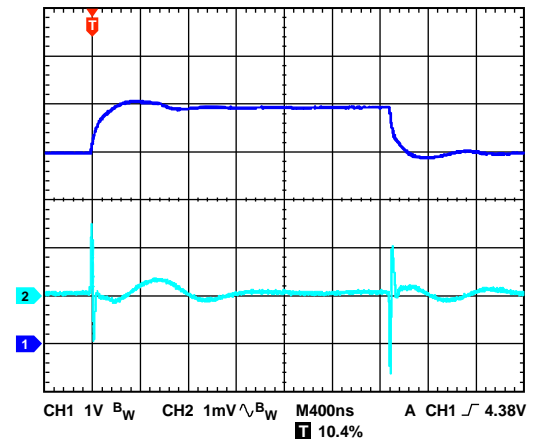

Figure 39. Line Transient Response, 1V Input Step,  $I_{LOAD} = 600\text{ mA}$ ,  $V_{OUT} = 3.3\text{ V}$ ,  $V_{IN} = 3.9\text{ V}$ , CH1 =  $V_{IN}$ , CH2 =  $V_{OUT}$



Figure 37. Load Transient Response,  $I_{LOAD} = 10\text{ mA to }510\text{ mA}$ ,  $V_{OUT} = 1.8\text{ V}$ ,  $V_{IN} = 2.3\text{ V}$ , CH1 =  $I_{OUT}$ , CH2 =  $V_{OUT}$

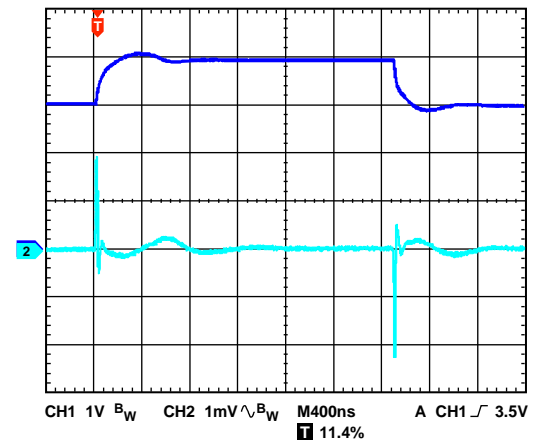

Figure 40. Line Transient Response, 1V Input Step,  $I_{LOAD} = 600\text{ mA}$ ,  $V_{OUT} = 1.8\text{ V}$ ,  $V_{IN} = 2.4\text{ V}$ , CH1 =  $V_{IN}$ , CH2 =  $V_{OUT}$

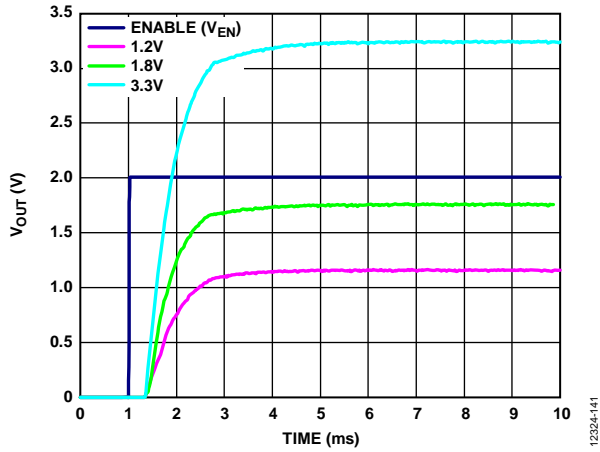

Figure 41.  $V_{OUT}$  Start-Up Time After  $V_{EN}$  Rising, Different Output Voltages,  $V_{IN} = 5\text{ V}$

## THEORY OF OPERATION

The **ADM7154** is an ultralow noise, high power supply rejection ratio (PSRR) linear regulator targeting radio frequency (RF) applications. The input voltage range is 2.3 V to 5.5 V, and it can deliver up to 600 mA of load current. Typical shutdown current consumption is 0.2  $\mu$ A at room temperature.

Optimized for use with 10  $\mu$ F ceramic capacitors, the **ADM7154** provides excellent transient performance.

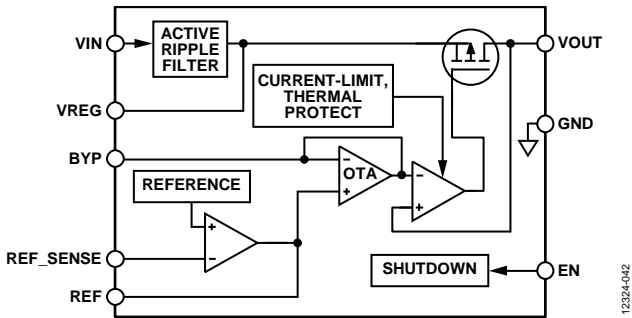

Figure 42. Simplified Internal Block Diagram

Internally, the **ADM7154** consists of a reference, an error amplifier, and a P-channel MOSFET pass transistor. Output current is delivered via the PMOS pass device, which is controlled by the error amplifier. The error amplifier compares the reference voltage with the feedback voltage from the output and amplifies the difference. If the feedback voltage is lower than the reference voltage, the gate of the PMOS device is pulled lower, allowing more current to pass and increasing the output voltage. If the feedback voltage is higher than the reference voltage, the gate of the PMOS device is pulled higher, allowing less current to pass and decreasing the output voltage.

By heavily filtering the reference voltage, the **ADM7154** is able to achieve 1.5 nV/ $\sqrt{\text{Hz}}$  output typical from 10 kHz to 1 MHz. Because the error amplifier is always in unity gain, the output noise is independent of the output voltage.

To maintain very high PSRR over a wide frequency range, the **ADM7154** architecture uses an internal active ripple filter. This stage isolates the low output noise LDO from noise on the VIN pin. The result is that the PSRR of the **ADM7154** is significantly higher over a wider frequency range than any single stage LDO.

The **ADM7154** uses the EN pin to enable and disable the VOUT pin under normal operating conditions. When EN is high, VOUT turns on, and when EN is low, VOUT turns off. For automatic startup, tie EN to VIN.

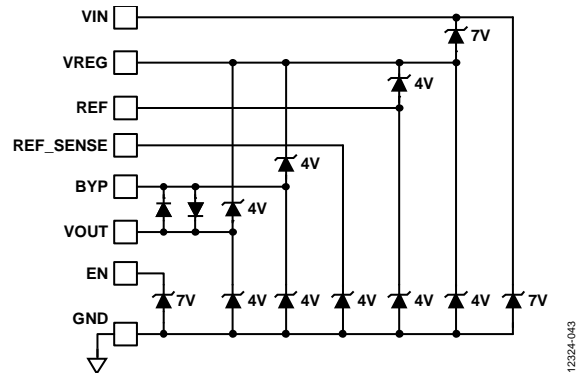

Figure 43. Simplified ESD Protection Block Diagram

The ESD protection devices are shown in the block diagram as Zener diodes (see Figure 43).

## APPLICATIONS INFORMATION

### ADIsimPOWER DESIGN TOOL

The ADM7154 is supported by the ADIsimPower™ design tool set. ADIsimPower is a collection of tools that produce complete power designs optimized for a specific design goal. The tools enable the user to generate a full schematic, bill of materials, and calculate performance within minutes. ADIsimPower can optimize designs for cost, area, efficiency, and device count, taking into consideration the operating conditions and limitations of the IC and all real external components. For more information about, and to obtain ADIsimPower design tools, visit [www.analog.com/ADIsimPower](http://www.analog.com/ADIsimPower).

### CAPACITOR SELECTION

Multilayer ceramic capacitors (MLCCs) combine small size, low ESR, low ESL, and wide operating temperature range, making them an ideal choice for bypass capacitors. They are not without faults, however. Depending on the dielectric material, the capacitance can vary dramatically with temperature, dc bias, and ac signal level. Therefore, selecting the proper capacitor results in the best circuit performance.

#### Output Capacitor

The ADM7154 is designed for operation with ceramic capacitors but functions with most commonly used capacitors when care is taken with regard to the effective series resistance (ESR) value. The ESR of the output capacitor affects the stability of the LDO control loop. A minimum of 10  $\mu\text{F}$  capacitance with an ESR of 0.2  $\Omega$  or less is recommended to ensure the stability of the ADM7154. Output capacitance also affects transient response to changes in load current. Using a larger value of output capacitance improves the transient response of the ADM7154 to large changes in load current. Figure 44 shows the transient responses for an output capacitance value of 10  $\mu\text{F}$ .

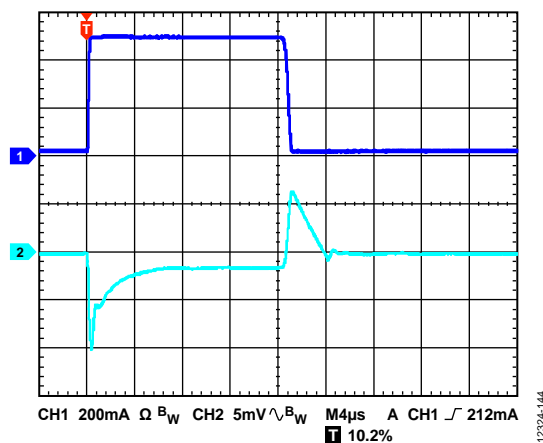

Figure 44. Output Transient Response,  $V_{OUT} = 3.3\text{ V}$ ,  $C_{OUT} = 10\ \mu\text{F}$ , CH1 = Load Current, CH2 =  $V_{OUT}$

#### Input and VREG Capacitor

Connecting a 10  $\mu\text{F}$  capacitor from VIN to GND reduces the circuit sensitivity to PCB layout, especially when long input traces or high source impedance are encountered.

To maintain the best possible stability and PSRR performance, connect a 10  $\mu\text{F}$  capacitor from VREG to GND. When more than 10  $\mu\text{F}$  of output capacitance is required, increase the input and the VREG capacitors,  $C_{REG}$ , to match it.

#### REF Capacitor

The REF capacitor,  $C_{REF}$ , is necessary to stabilize the reference amplifier. Connect at least a 1  $\mu\text{F}$  capacitor between REF and GND.

#### BYP Capacitor

The BYP capacitor,  $C_{BYP}$ , is necessary to filter the reference buffer. A 1  $\mu\text{F}$  capacitor is typically connected between BYP and GND. Capacitors as small as 0.1  $\mu\text{F}$  can be used; however, the output noise voltage of the LDO increases as a result.

In addition, the BYP capacitor value can be increased to reduce the noise below 1 kHz at the expense of increasing the start-up time of the LDO. Very large values of  $C_{BYP}$  significantly reduce the noise below 10 Hz. Tantalum capacitors are recommended for capacitors larger than approximately 33  $\mu\text{F}$  because solid tantalum capacitors are less prone to microphonic noise issues. A 1  $\mu\text{F}$  ceramic capacitor in parallel with the larger tantalum capacitor is recommended to ensure good noise performance at higher frequencies.

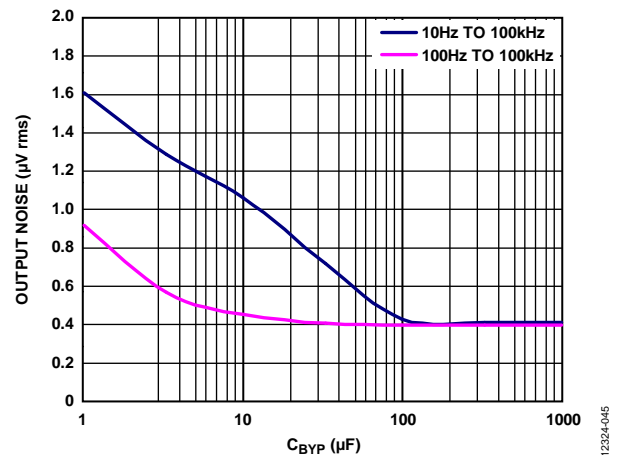

Figure 45. RMS Noise vs.  $C_{BYP}$



Figure 46. Noise Spectral Density vs. Frequency at Different Capacitances ( $C_{BYP}$ )

**Capacitor Properties**

Any good quality ceramic capacitors can be used with the ADM7154 if they meet the minimum capacitance and maximum ESR requirements. Ceramic capacitors are manufactured with a variety of dielectrics, each with different behavior over temperature and applied voltage. Capacitors must have a dielectric adequate to ensure the minimum capacitance over the necessary temperature range and dc bias conditions. X5R or X7R dielectrics with a voltage rating of 6.3 V to 50 V are recommended. However, Y5V and Z5U dielectrics are not recommended because of their poor temperature and dc bias characteristics.

Figure 47 depicts the capacitance vs. dc bias voltage of a 1206, 10 µF, 10 V, X5R capacitor. The voltage stability of a capacitor is strongly influenced by the capacitor size and voltage rating. In general, a capacitor in a larger package or higher voltage rating exhibits better stability. The temperature variation of the X5R dielectric is  $\sim \pm 15\%$  over the  $-40^\circ\text{C}$  to  $+85^\circ\text{C}$  temperature range and is not a function of package or voltage rating.



Figure 47. Capacitance vs. DC Bias Voltage

Use Equation 1 to determine the worst case capacitance accounting for capacitor variation over temperature, component tolerance, and voltage.

$$C_{EFF} = C_{BIAS} \times (1 - TEMPCO) \times (1 - TOL) \tag{1}$$

where:

$C_{BIAS}$  is the effective capacitance at the operating voltage.

$TEMPCO$  is the worst case capacitor temperature coefficient.

$TOL$  is the worst case component tolerance.

In this example, the worst case temperature coefficient ( $TEMPCO$ ) over  $-40^\circ\text{C}$  to  $+85^\circ\text{C}$  is assumed to be 15% for an X5R dielectric. The tolerance of the capacitor ( $TOL$ ) is assumed to be 10%, and  $C_{BIAS}$  is 9.72 µF at 5 V, as shown in Figure 47.

Substituting these values in Equation 1 yields

$$C_{EFF} = 9.72 \mu\text{F} \times (1 - 0.15) \times (1 - 0.1) = 7.44 \mu\text{F}$$

Therefore, the capacitor chosen in this example meets the minimum capacitance requirement of the LDO over temperature and tolerance at the chosen output voltage.

To guarantee the performance of the ADM7154, it is imperative that the effects of dc bias, temperature, and tolerances on the behavior of the capacitors be evaluated for each application.

**UNDERVOLTAGE LOCKOUT (UVLO)**

The ADM7154 also incorporates an internal UVLO circuit to disable the output voltage when the input voltage is less than the minimum input voltage rating of the regulator. The upper and lower thresholds are internally fixed with about 200 mV of hysteresis.

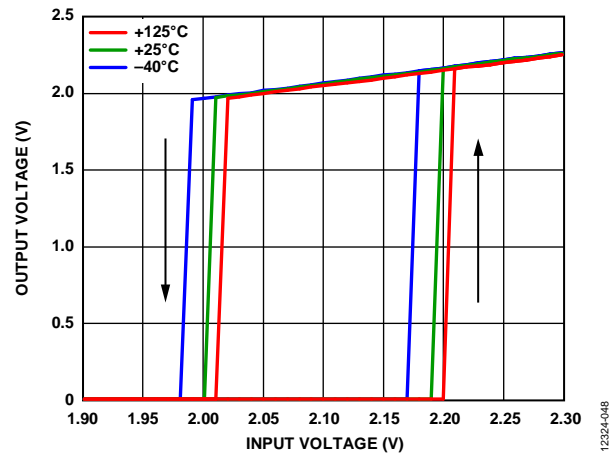

Figure 48. Typical UVLO Behavior at Different Temperatures,  $V_{OUT} = 3.3 \text{ V}$

Figure 48 shows the typical hysteresis of the UVLO function. This hysteresis prevents on/off oscillations that can occur when caused by noise on the input voltage as it passes through the threshold points.



**PROGRAMMABLE PRECISION ENABLE**

The ADM7154 uses the EN pin to enable and disable the VOUT pin under normal operating conditions. As shown in Figure 49, when a rising voltage on EN crosses the upper threshold, nominally 1.22 V, VOUT turns on. When a falling voltage on EN crosses the lower threshold, nominally 1.13 V, VOUT turns off. The hysteresis of the EN threshold is approximately 90 mV.

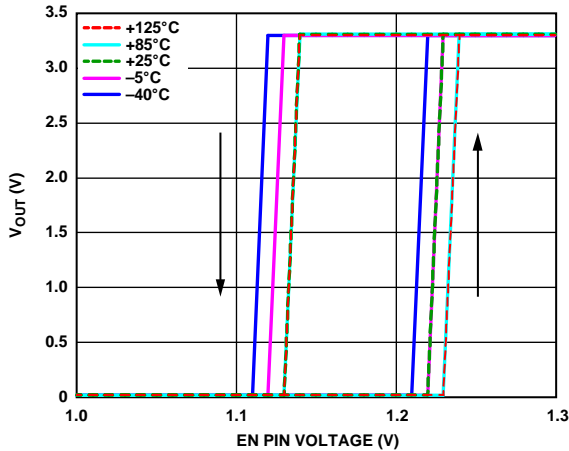

Figure 49. Typical VOUT Response to EN Pin Operation

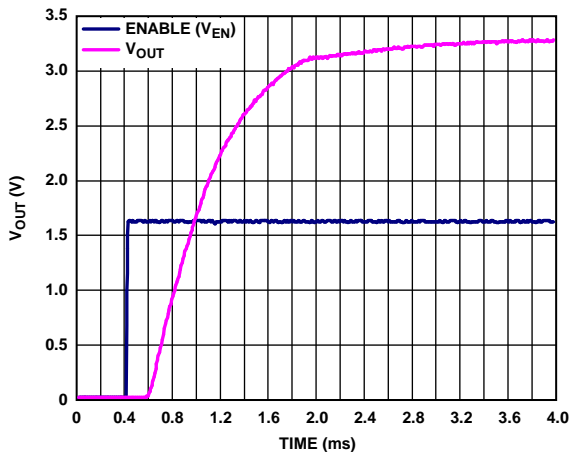

Figure 50. Typical VOUT Response to EN Pin Operation (VEN), VOUT = 3.3 V, VIN = 5 V, CBYP = 1 μF

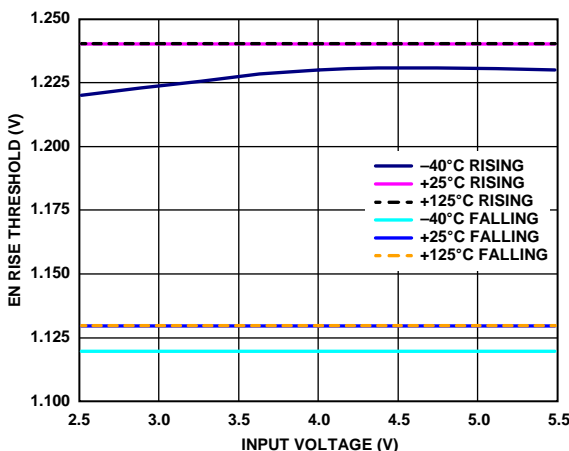

Figure 51. Typical EN Threshold vs. Input Voltages (VIN) for Different Temperatures

The upper and lower thresholds are user programmable and can be set higher than the nominal 1.22 V threshold by using two resistors. The resistance values, REN1 and REN2, can be determined from

$$R_{EN1} = R_{EN2} \times (V_{IN} - 1.22 \text{ V}) / 1.22 \text{ V}$$

where:

REN2 typically ranges from 10 kΩ to 100 kΩ.

VIN is the desired turn-on voltage.

The hysteresis voltage increases by the factor

$$(R_{EN1} + R_{EN2}) / R_{EN2}$$

For the example shown in Figure 52, the EN threshold is 2.44 V with a hysteresis of 200 mV.

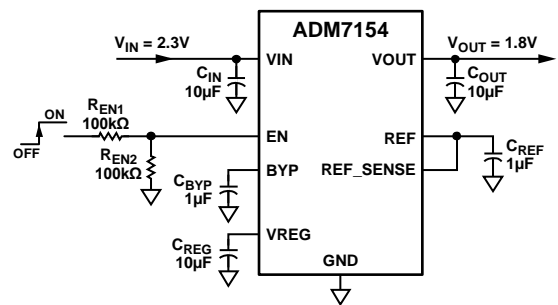

Figure 52. Typical EN Pin Voltage Divider

Figure 52 shows the typical hysteresis of the EN pin. This prevents on/off oscillations that can occur due to noise on the EN pin as it passes through the threshold points.

**START-UP TIME**

The ADM7154 uses an internal soft start to limit the inrush current when the output is enabled. The start-up time for a 3.3 V output is approximately 1.2 ms from the time the EN active threshold is crossed to when the output reaches 90% of the final value.

The rise time in seconds of the output voltage (10% to 90%) is approximately

$$0.0012 \times C_{BYP}$$

where CBYP is in microfarads.



Figure 53. Typical Start-Up Behavior with CBYP = 1 μF to 10 μF

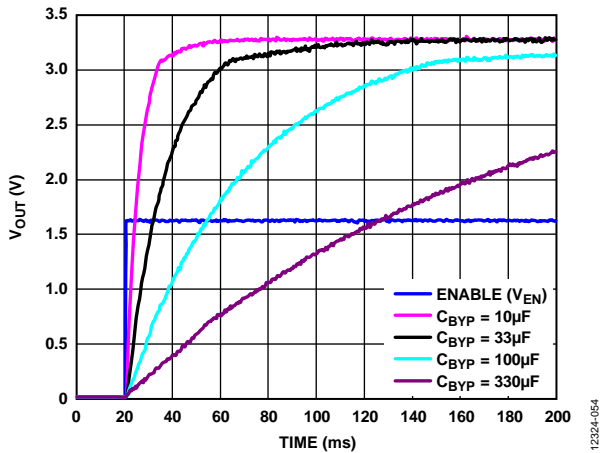

Figure 54. Typical Start-Up Behavior with  $C_{BYP} = 10 \mu\text{F}$  to  $330 \mu\text{F}$

## REF, BYP, AND VREG PINS

REF, BYP, and VREG generate voltages internally ( $V_{REF}$ ,  $V_{BYP}$ , and  $V_{REG}$ ) that require external bypass capacitors for proper operation. Do not, under any circumstances, connect any loads to these pins, because doing so compromises the noise and PSRR performance of the ADM7154. Using larger values of  $C_{BYP}$ ,  $C_{REF}$ , and  $C_{REG}$  is acceptable but can increase the start-up time, as described in the Start-Up Time section.

## CURRENT-LIMIT AND THERMAL OVERLOAD PROTECTION

The ADM7154 is protected against damage due to excessive power dissipation by current and thermal overload protection circuits. The ADM7154 is designed to current limit when the output load reaches 960 mA (typical). When the output load exceeds 960 mA, the output voltage is reduced to maintain a constant current limit.

Thermal overload protection is included, which limits the junction temperature to a maximum of 150°C. Under extreme conditions (that is, high ambient temperature and/or high power dissipation), when the junction temperature starts to rise above 150°C, the output is turned off, reducing the output current to zero. When the junction temperature drops below 135°C, the output is turned on again, and the output current is restored to the operating value.

Consider the case where a hard short from VOUT to GND occurs. At first, the ADM7154 current limits, so that only 960 mA is conducted into the short. If self heating of the junction is great enough to cause the temperature to rise above 150°C, thermal shutdown activates, turning off the output and reducing the output current to zero. As the junction temperature cools and drops below 135°C, the output turns on and conducts 900 mA into the short, again causing the junction temperature to rise above 150°C. This thermal oscillation between 135°C and 150°C causes a current oscillation between 900 mA and 0 mA that continues for as long as the short remains at the output.

Current-limit and thermal limit protections are intended to protect the device against accidental overload conditions. For reliable operation, device power dissipation must be externally limited so that the junction temperature does not exceed 150°C.

## THERMAL CONSIDERATIONS

In applications with a low input to output voltage differential, the ADM7154 does not dissipate much heat. However, in applications with high ambient temperature and/or high input voltage, the heat dissipated in the package can become large enough that it causes the junction temperature of the die to exceed the maximum junction temperature of 150°C.

When the junction temperature exceeds 150°C, the converter enters thermal shutdown. It recovers only after the junction temperature decreases below 135°C to prevent any permanent damage. Therefore, thermal analysis for the chosen application is important to guarantee reliable performance over all conditions. The junction temperature of the die is the sum of the ambient temperature of the environment and the temperature rise of the package due to the power dissipation, as shown in Equation 2.

To guarantee reliable operation, the junction temperature of the ADM7154 must not exceed 150°C. To ensure that the junction temperature stays below this maximum value, the user must be aware of the parameters that contribute to junction temperature changes. These parameters include ambient temperature, power dissipation in the power device, and thermal resistances between the junction and ambient air ( $\theta_{JA}$ ). The  $\theta_{JA}$  number is dependent on the package assembly compounds that are used and the amount of copper used to solder the package GND pin and exposed pad to the PCB.

Table 7 shows typical  $\theta_{JA}$  values of the 8-lead SOIC and 8-lead LFCSP packages for various PCB copper sizes.

Table 8 shows the typical  $\Psi_{JB}$  values of the 8-lead SOIC and 8-lead LFCSP.

Table 7. Typical  $\theta_{JA}$  Values

| Copper Size (mm <sup>2</sup> ) | $\theta_{JA}$ (°C/W) |             |
|--------------------------------|----------------------|-------------|
|                                | 8-Lead LFCSP         | 8-Lead SOIC |
| 25 <sup>1</sup>                | 165.1                | 165         |
| 100                            | 125.8                | 126.4       |
| 500                            | 68.1                 | 69.8        |
| 1000                           | 56.4                 | 57.8        |
| 6400                           | 42.1                 | 43.6        |

<sup>1</sup> Device soldered to minimum size pin traces.

Table 8. Typical  $\Psi_{JB}$  Values

| Package      | $\Psi_{JB}$ (°C/W) |
|--------------|--------------------|
| 8-Lead LFCSP | 15.1               |
| 8-Lead SOIC  | 17.9               |

The junction temperature of the ADM7154 is calculated from the following equation:

$$T_J = T_A + (P_D \times \theta_{JA}) \tag{2}$$

where:

$T_A$  is the ambient temperature.

$P_D$  is the power dissipation in the die, given by

$$P_D = ((V_{IN} - V_{OUT}) \times I_{LOAD}) + (V_{IN} \times I_{GND}) \tag{3}$$

where:

$V_{IN}$  and  $V_{OUT}$  are the input and output voltages, respectively.

$I_{LOAD}$  is the load current.

$I_{GND}$  is the ground current.

Power dissipation caused by ground current is quite small and can be ignored. Therefore, the junction temperature equation simplifies to the following:

$$T_J = T_A + (((V_{IN} - V_{OUT}) \times I_{LOAD}) \times \theta_{JA}) \tag{4}$$

As shown in Equation 4, for a given ambient temperature, input to output voltage differential, and continuous load current, there exists a minimum copper size requirement for the PCB to ensure that the junction temperature does not rise above 150°C.

The heat dissipation from the package can be improved by increasing the amount of copper attached to the pins and exposed pad of the ADM7154. Adding thermal planes underneath the package also improves thermal performance. However, as shown in Table 7, a point of diminishing returns is eventually reached, beyond which an increase in the copper area does not yield significant reduction in the junction to ambient thermal resistance.

Figure 55 to Figure 60 show junction temperature calculations for different ambient temperatures, power dissipation, and areas of PCB copper.

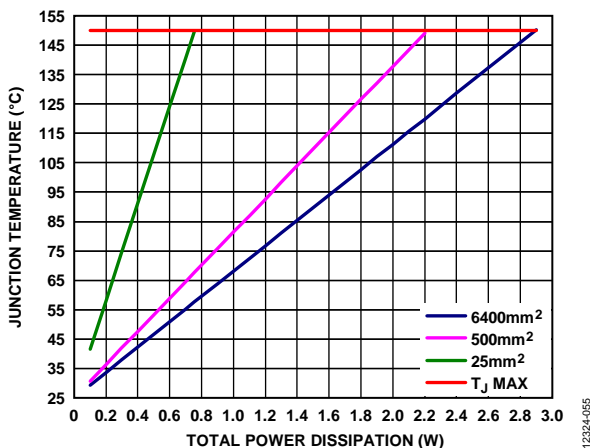

Figure 55. Junction Temperature vs. Total Power Dissipation for the 8-Lead LFCSP,  $T_A = 25^\circ\text{C}$



Figure 56. Junction Temperature vs. Total Power Dissipation for the 8-Lead LFCSP,  $T_A = 50^\circ\text{C}$

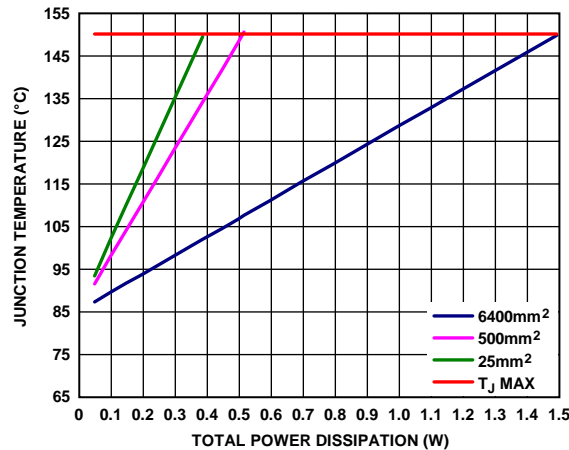

Figure 57. Junction Temperature vs. Total Power Dissipation for the 8-Lead LFCSP,  $T_A = 85^\circ\text{C}$

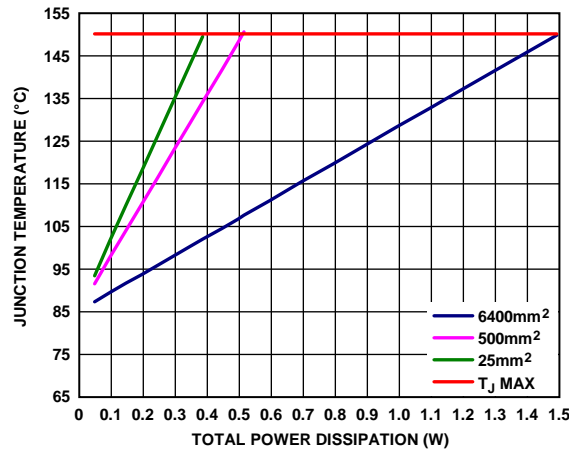

Figure 58. Junction Temperature vs. Total Power Dissipation for the 8-Lead SOIC,  $T_A = 25^\circ\text{C}$

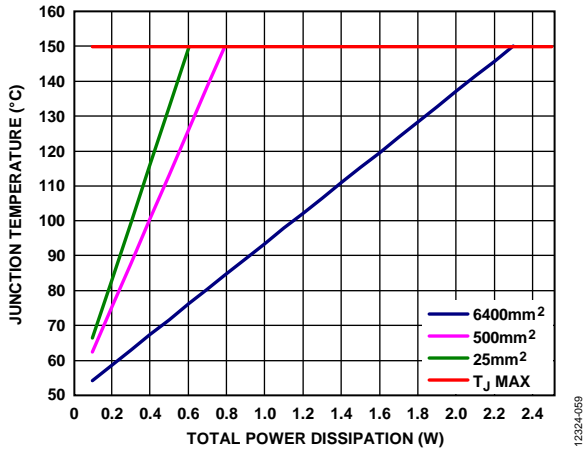

Figure 59. Junction Temperature vs. Total Power Dissipation for the 8-Lead SOIC,  $T_A = 50^\circ\text{C}$

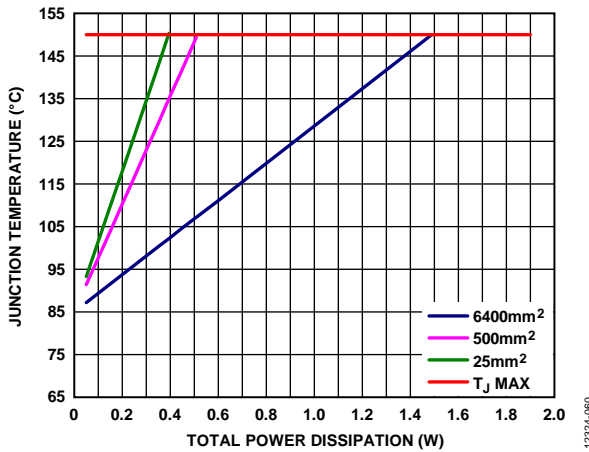

Figure 60. Junction Temperature vs. Total Power Dissipation for the 8-Lead SOIC,  $T_A = 85^\circ\text{C}$

**Thermal Characterization Parameter ( $\Psi_{JB}$ )**

When board temperature is known, use the thermal characterization parameter,  $\Psi_{JB}$ , to estimate the junction temperature rise (see Figure 61 and Figure 62). Maximum junction temperature ( $T_J$ ) is calculated from the board temperature ( $T_B$ ) and power dissipation ( $P_D$ ) using the following formula:

$$T_J = T_B + (P_D \times \Psi_{JB}) \tag{5}$$

The typical value of  $\Psi_{JB}$  is  $15.1^\circ\text{C/W}$  for the 8-lead LFCSP package and  $17.9^\circ\text{C/W}$  for the 8-lead SOIC package.

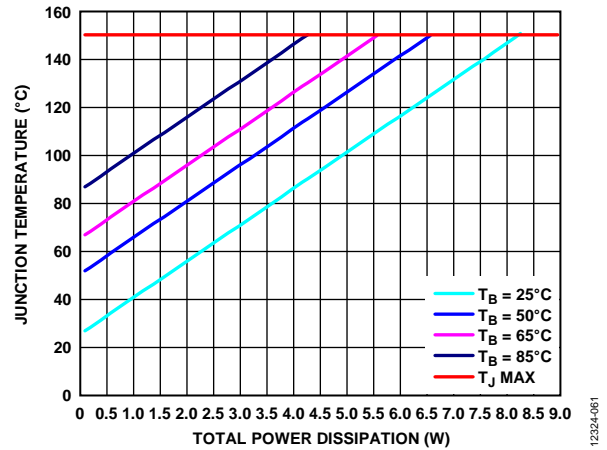

Figure 61. Junction Temperature vs. Total Power Dissipation for the 8-Lead LFCSP

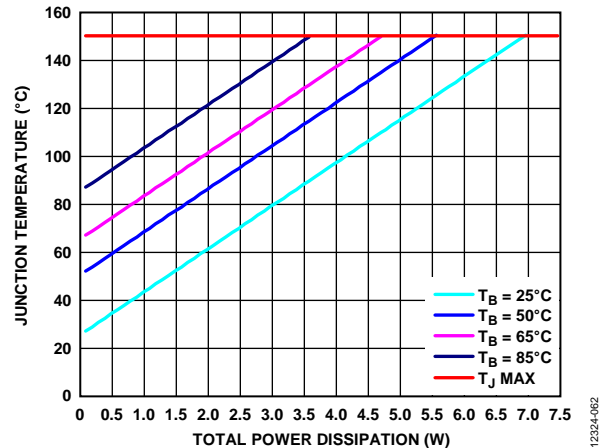

Figure 62. Junction Temperature vs. Total Power Dissipation for the 8-Lead SOIC

### PCB LAYOUT CONSIDERATIONS

Place the input capacitor as close as possible to the VIN and GND pins. Place the output capacitor as close as possible to the VOUT and GND pins. Place the bypass capacitors ( $C_{REG}$ ,  $C_{REF}$ , and  $C_{BYP}$ ) for  $V_{REG}$ ,  $V_{REF}$ , and  $V_{BYP}$  close to the respective pins ( $V_{REG}$ ,  $REF$ , and  $BYP$ ) and GND. Use of an 0805, 0603, or 0402 size capacitor achieves the smallest possible footprint solution on boards where area is limited.

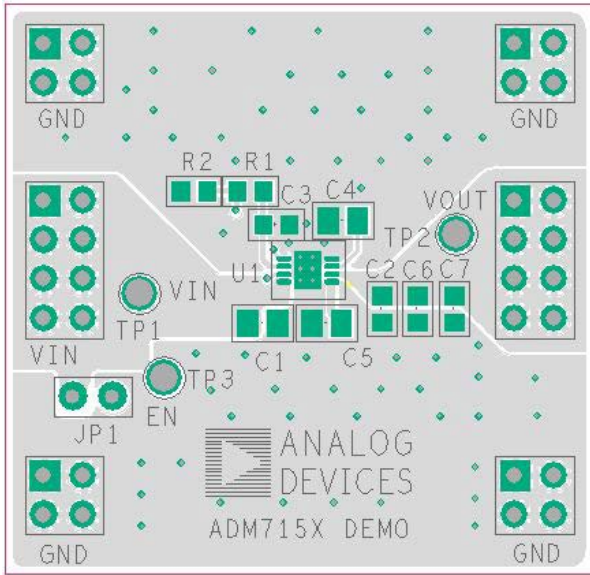

Figure 63. Example 8-Lead LFCSP PCB Layout

12324-083

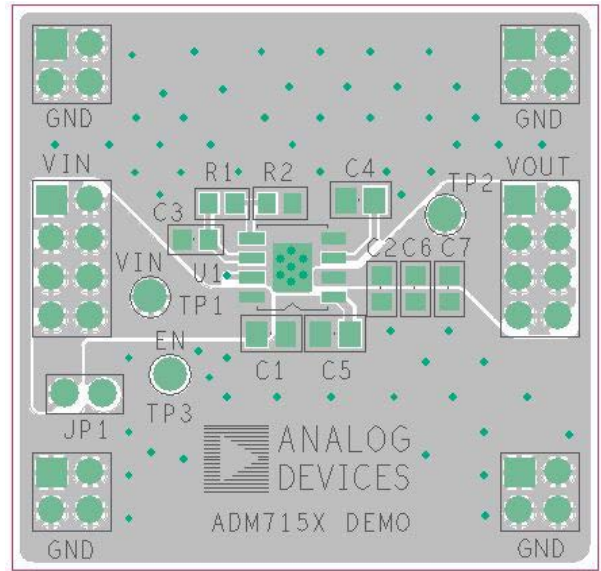

Figure 64. Example 8-Lead SOIC PCB Layout

12324-084

OUTLINE DIMENSIONS



Figure 65. 8-Lead Lead Frame Chip Scale Package [LFCSF\_WD]  
 3 mm x 3 mm Body, Very Very Thin, Dual Lead  
 (CP-8-21)  
 Dimensions shown in millimeters

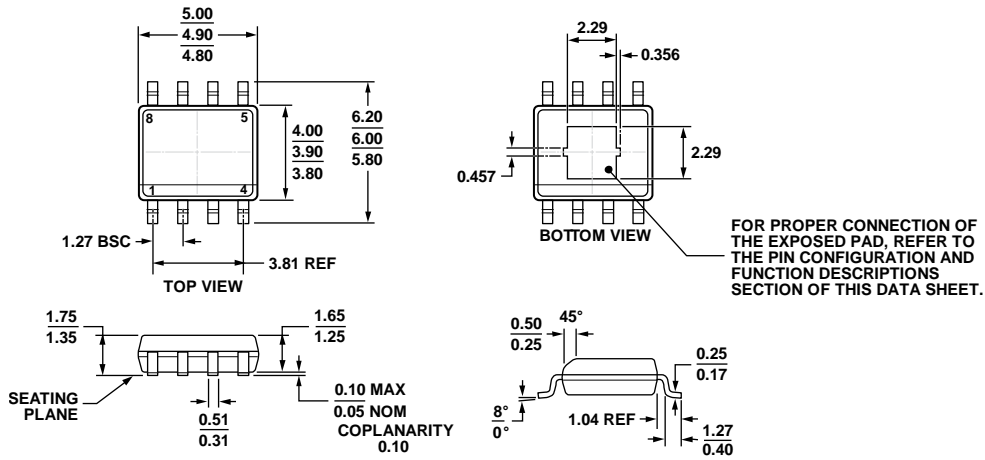

COMPLIANT TO JEDEC STANDARDS MS-012-A A  
 Figure 66. 8-Lead Standard Small Outline Package, with Exposed Pad [SOIC\_N\_EP]  
 Narrow Body  
 (RD-8-1)  
 Dimensions shown in millimeters

## ORDERING GUIDE

| Model <sup>1</sup> | Temperature Range | Output Voltage (V) | Package Description | Package Option | Branding |
|--------------------|-------------------|--------------------|---------------------|----------------|----------|
| ADM7154ACPZ-1.2-R7 | -40°C to +125°C   | 1.2                | 8-Lead LFCSP_WD     | CP-8-21        | LQS      |
| ADM7154ACPZ-1.8-R7 | -40°C to +125°C   | 1.8                | 8-Lead LFCSP_WD     | CP-8-21        | LQT      |
| ADM7154ACPZ-2.5-R7 | -40°C to +125°C   | 2.5                | 8-Lead LFCSP_WD     | CP-8-21        | LQU      |
| ADM7154ACPZ-2.8-R7 | -40°C to +125°C   | 2.8                | 8-Lead LFCSP_WD     | CP-8-21        | LQ6      |
| ADM7154ACPZ-3.0-R7 | -40°C to +125°C   | 3.0                | 8-Lead LFCSP_WD     | CP-8-21        | LRF      |
| ADM7154ACPZ-3.3-R7 | -40°C to +125°C   | 3.3                | 8-Lead LFCSP_WD     | CP-8-21        | LQ7      |
| ADM7154ARDZ-1.2-R7 | -40°C to +125°C   | 1.2                | 8-Lead SOIC_N_EP    | RD-8-1         |          |
| ADM7154ARDZ-1.8-R7 | -40°C to +125°C   | 1.8                | 8-Lead SOIC_N_EP    | RD-8-1         |          |
| ADM7154ARDZ-2.5-R7 | -40°C to +125°C   | 2.5                | 8-Lead SOIC_N_EP    | RD-8-1         |          |
| ADM7154ARDZ-2.8-R7 | -40°C to +125°C   | 2.8                | 8-Lead SOIC_N_EP    | RD-8-1         |          |
| ADM7154ARDZ-3.0-R7 | -40°C to +125°C   | 3.0                | 8-Lead SOIC_N_EP    | RD-8-1         |          |
| ADM7154ARDZ-3.3-R7 | -40°C to +125°C   | 3.3                | 8-Lead SOIC_N_EP    | RD-8-1         |          |
| ADM7154CP-3.3EVALZ |                   |                    | Evaluation Board    |                |          |
| ADM7154RD-1.8EVALZ |                   |                    | Evaluation Board    |                |          |

<sup>1</sup> Z = RoHS Compliant Part.

Компания «Океан Электроники» предлагает заключение долгосрочных отношений при поставках импортных электронных компонентов на взаимовыгодных условиях!

Наши преимущества:

- Поставка оригинальных импортных электронных компонентов напрямую с производств Америки, Европы и Азии, а так же с крупнейших складов мира;
- Широкая линейка поставок активных и пассивных импортных электронных компонентов (более 30 млн. наименований);
- Поставка сложных, дефицитных, либо снятых с производства позиций;
- Оперативные сроки поставки под заказ (от 5 рабочих дней);
- Экспресс доставка в любую точку России;
- Помощь Конструкторского Отдела и консультации квалифицированных инженеров;
- Техническая поддержка проекта, помощь в подборе аналогов, поставка прототипов;
- Поставка электронных компонентов под контролем ВП;
- Система менеджмента качества сертифицирована по Международному стандарту ISO 9001;
- При необходимости вся продукция военного и аэрокосмического назначения проходит испытания и сертификацию в лаборатории (по согласованию с заказчиком);
- Поставка специализированных компонентов военного и аэрокосмического уровня качества (Xilinx, Altera, Analog Devices, Intersil, Interpoint, Microsemi, Actel, Aeroflex, Peregrine, VPT, Syfer, Eurofarad, Texas Instruments, MS Kennedy, Miteq, Cobham, E2V, MA-COM, Hittite, Mini-Circuits, General Dynamics и др.);

Компания «Океан Электроники» является официальным дистрибьютором и эксклюзивным представителем в России одного из крупнейших производителей разъемов военного и аэрокосмического назначения «JONHON», а так же официальным дистрибьютором и эксклюзивным представителем в России производителя высокотехнологичных и надежных решений для передачи СВЧ сигналов «FORSTAR».



## JONHON

«JONHON» (основан в 1970 г.)

Разъемы специального, военного и аэрокосмического назначения:

(Применяются в военной, авиационной, аэрокосмической, морской, железнодорожной, горно- и нефтедобывающей отраслях промышленности)

«FORSTAR» (основан в 1998 г.)

ВЧ соединители, коаксиальные кабели,  
кабельные сборки и микроволновые компоненты:

(Применяются в телекоммуникациях гражданского и специального назначения, в средствах связи, РЛС, а так же военной, авиационной и аэрокосмической отраслях промышленности).



Телефон: 8 (812) 309-75-97 (многоканальный)

Факс: 8 (812) 320-03-32

Электронная почта: [ocean@oceanchips.ru](mailto:ocean@oceanchips.ru)

Web: <http://oceanchips.ru/>

Адрес: 198099, г. Санкт-Петербург, ул. Калинина, д. 2, корп. 4, лит. А