

nRF24AP2

nRF24AP2-USB

Single-chip ANT™ ultra-low power wireless network solution

Product Specification v1.0

Key Features

- Second generation single chip ANT solution
- Bridge from ANT networks and devices to computers, Macs, and the internet
- nRF24AP2- USB supports up to eight ANT (logic) channels – ideal for hubs
- World wide 2.4 GHz ISM band operation
- USB v2.0 interface
- Fully embedded, enhanced ANT protocol stack
- Built-in device search and pairing
- Built-in timing and power management
- Built-in interference handling
- Configurable channel period 5.2 ms - 2 s
- Broadcast, Acknowledged and Burst communication modes
- Burst data rate up to 20 kbps
- Simple to complex network topologies: Peer-to-peer, star, tree and practical mesh
- Supports public, private and managed networks
- Support for ANT+ device profile implementations enabling multivendor interoperability
- Fully interoperable with nRF24AP1, Dynastream ANT chipset / module based products and other nRF24AP2 variants
- RoHS compliant 5x5 mm 32-pin QFN package
- Low cost external 16 MHz crystal

Applications

- Sports
- Wellness
- Home health monitoring
- Home/industrial automation
- Environmental sensor networks
- Active RFID
- Logistics/goods tracking
- Audience-response systems

Liability disclaimer

Nordic Semiconductor ASA reserves the right to make changes without further notice to the product to improve reliability, function or design. Nordic Semiconductor ASA does not assume any liability arising out of the application or use of any product or circuits described herein.

All application information is advisory and does not form part of the specification.

Limiting values

Stress above one or more of the limiting values may cause permanent damage to the device. These are stress ratings only and operation of the device at these or at any other conditions above those given in the specifications are not implied. Exposure to limiting values for extended periods may affect device reliability.

Life support applications

Nordic Semiconductor's products are not designed for use in life support appliances, devices, or systems where malfunction of these products can reasonably be expected to result in personal injury. Nordic Semiconductor ASA customers using or selling these products for use in such applications do so at their own risk and agree to fully indemnify Nordic Semiconductor ASA for any damages resulting from such improper use or sale.

Datasheet status	
Objective product specification	This product specification contains target specifications for Nordic Semiconductor's product development.
Preliminary product specification	This product specification contains preliminary data; supplementary data may be published from Nordic Semiconductor ASA later.
Product specification	This product specification contains final product specifications. Nordic Semiconductor ASA reserves the right to make changes at any time without notice in order to improve design and supply the best possible product.

Contact details

For your nearest dealer, please see www.nordicsemi.com.

Main office:

Otto Nielsens veg 12
 7004 Trondheim
 Phone: +47 72 89 89 00
 Fax: +47 72 89 89 89
www.nordicsemi.com



RoHS statement

This product meets the requirements of Directive 2002/95/EC of the European Parliament and of the Council on the Restriction of Hazardous Substances (RoHS). Complete hazardous substance reports as well as material composition reports for all active Nordic products can be found on our web site www.nordicsemi.com.

Revision History

Date	Version	Description
April 2010	1.0	Product Specification

Contents

1	Introduction	6
1.1	Prerequisites	6
1.2	Writing conventions	6
2	Product overview	7
2.1	Features	8
2.2	Block diagram	9
2.3	Pin Assignments	10
2.4	Pin Functions	10
2.4.1	Power supply pins	11
2.4.2	Reset pin	11
3	RF transceiver	12
3.1	Features	12
3.2	Block diagram	12
4	ANT overview	13
4.1	Block diagram	13
4.2	Functional description	13
4.2.1	ANT nodes	14
4.2.2	ANT channels	14
4.2.3	ANT channel configuration	15
4.2.4	Proximity search	17
4.2.5	Continuous scanning mode	18
4.2.6	ANT network topologies	18
4.2.7	ANT message protocol	19
5	Host interface	21
5.1	Features	21
5.2	Block diagram	21
5.3	Functional description	21
5.3.1	Physical USB connection	22
5.3.2	USB enumeration	22
5.3.3	USB descriptors	22
5.3.4	String descriptors	25
5.3.5	Customize descriptors	25
5.3.6	Control transfer	26
5.3.7	Host Command flow	28
6	On-chip oscillator	30
6.1	Features	30
6.2	Block diagram	30
6.3	Functional description	30
6.3.1	16 MHz crystal oscillator	30
6.3.2	External 16 MHz clock	31
7	Operating conditions	32
8	Electrical specifications	33
8.1	USB interface	34
8.2	DC Electrical characteristics	35

8.3	Current consumption.....	36
9	Absolute maximum ratings	37
10	Mechanical specification.....	38
11	Reference circuitry.....	39
11.1	PCB guidelines.....	39
11.2	Schematics.....	40
11.3	Layout	41
11.4	Bill Of Materials (BOM)	42
12	Ordering information	43
12.1	Package marking	43
12.1.1	Abbreviations.....	43
12.2	Product options	43
12.2.1	RF silicon.....	43
12.2.2	Development tools.....	43
13	Glossary.....	44

1 Introduction

The nRF24AP2 components belong to Nordic Semiconductor's low-cost, high-performance family of 2.4 GHz ISM Connectivity-on-Chip devices with the ANT protocol stack embedded. nRF24AP2 offers the market's most efficient, single chip, transceiver solution for Ultra Low Power (ULP) networks, through the integration of the extremely power efficient ANT protocol stack, the world leading Nordic Semiconductor 2.4 GHz RF technology as well as critical low-power oscillator and timing features.

This document covers the product nRF24AP2-USB, which is a single-chip implementation of an ANT USB bridge.

1.1 Prerequisites

In order to fully understand the product specification, a good knowledge of electronics and software engineering is necessary. Please also refer to the document *ANT Message Protocol and Usage* when reading this product specification. You can download the document from Nordic's web site www.nordicsemi.com or from www.thisisant.com.

1.2 Writing conventions

This product specification follows a set of typographic rules to ensure that the document is consistent and easy to read. The following writing conventions are used:

- Commands, bit state conditions, and register names are written in `Courier New`.
- Pin names and pin signal conditions are written in **Courier New bold**.
- Cross references are [underlined and highlighted in blue](#).

2 Product overview

ANT is a demonstrably superior Wireless Sensor Network (WSN) RF protocol for almost all practical ultra-low power networking applications – from simple point-to-point links to complex networks. Embedded in nRF24AP2 devices, it is paired up with Nordic Semiconductor's market leading 2.4 GHz radio technology. The combination gives you a high performance-, ultra-low-power network connectivity to applications.

The nRF24AP2-USB, with its USB v2.0 compatible serial interface, is made specifically to act as a bridge between an ANT wireless network and backbone infrastructure. Backbone infrastructure can be advanced user interfaces, storage on a computer or other USB enabled equipment.

[Figure 1. on page 7](#) shows a network in which a network node with nRF24AP2-USB embedded, communicates with up to eight ANT nodes. An example might be a computer collecting data from a hub (a watch) in a portable ANT sensor network containing several sensors (like heart rate-, speed and distance sensors). The 8-channel nRF24AP2-USB node can of course also set up ANT channels with other nodes (gym equipment, for instance). The information collected through nRF24AP2-USB can then be used either locally or shared with others over local networks or internet.

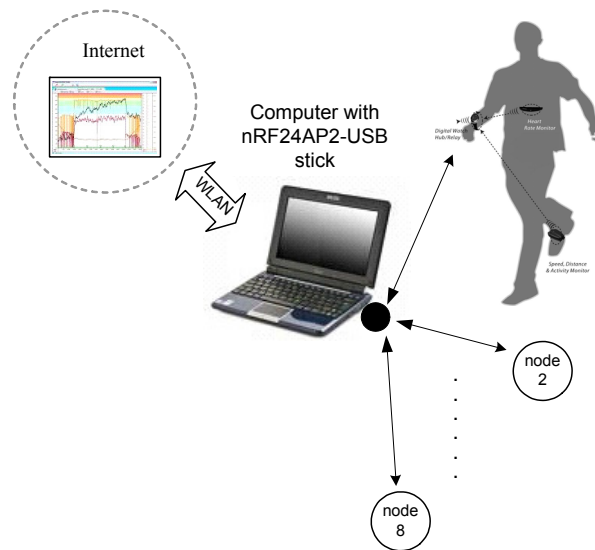

Figure 1. Simple setup with nRF24AP2-USB

See [Figure 10. on page 19](#) for more complex ANT-network topologies.

2.1 Features

Features of the nRF24AP2-USB include:

- Ultra low power 2.4 GHz transceiver
 - ▶ World wide 2.4 GHz ISM band operation
 - ▶ Based on nRF24L01+ transceiver
 - ▶ GFSK modulation
 - ▶ 1 Mbps on-air data rate
 - ▶ 1 MHz frequency resolution
 - ▶ 78 RF channels
 - ▶ -85 dBm sensitivity
 - ▶ Up to 0 dBm output power
- ANT protocol stack
 - ▶ Full implementation of the physical, data link, network- and transport OSI layers
 - ▶ Packet-based communication – 8 byte payload per packet
 - ▶ Optimized for ultra-low power operation
- ANT channels
 - ▶ Logic communication channel between ANT nodes
 - ▶ nRF24AP2USB support up to 8 channels—ideal for hubs
 - ▶ Built-in timing and power management
 - ▶ Built-in interference handling
 - ▶ Configurable channel period 5.2 ms - 2 s
 - ▶ Broadcast, acknowledged and burst communication modes
 - ▶ Burst data rate up to 20 kbps
- Device search and pairing
 - ▶ Wild-card searches
 - ▶ Proximity searches
 - ▶ Specific searches
 - ▶ Automatic link establishment if correct device is found
 - ▶ Automatic re-link attempt if link is lost
 - ▶ Configurable search timeout
- Network topologies
 - ▶ Point-to- point and star networks using independent ANT channels
 - ▶ Shared networks: Polled data collection (N:1) by using ANT shared channel option
 - ▶ Broadcast networks: Mass distribution of data (1:N)
- Network management / ANT+
 - ▶ Supports public and private (managed) networks
 - ▶ Support for ANT+ system implementations enabling multi-vendor interoperability
- ANT core stack enhancements
 - ▶ Background scanning channel
 - ▶ Continuous scanning mode
 - ▶ High density node support
 - ▶ Improved channel search
 - ▶ Channel ID management
 - ▶ Improved transmission power control on a per channel basis
 - ▶ Frequency agility
 - ▶ Proximity search
- Power Management
 - ▶ Fully controlled by ANT protocol stack
 - ▶ On-chip voltage regulator
 - ▶ USB supply operation
 - ▶ 4.0 to 5.25V supply range
- On-chip oscillators and clock inputs
 - ▶ 16 MHz crystal oscillator supporting low-cost crystals
- Host interface
 - ▶ USB v2.0 compatible
 - ▶ On-chip pull-up resistor on D+
 - ▶ Two control endpoints and two bulk endpoints
 - ▶ Suspend and resume power management functions
 - ▶ USB drivers and ANT command libraries supported by ANT

2.2 Block diagram

nRF24AP2 is composed of five main blocks as shown in [Figure 2](#). The blocks indicate the interface, power management, the ANT protocol engine, on-chip oscillators and the RF transceiver.

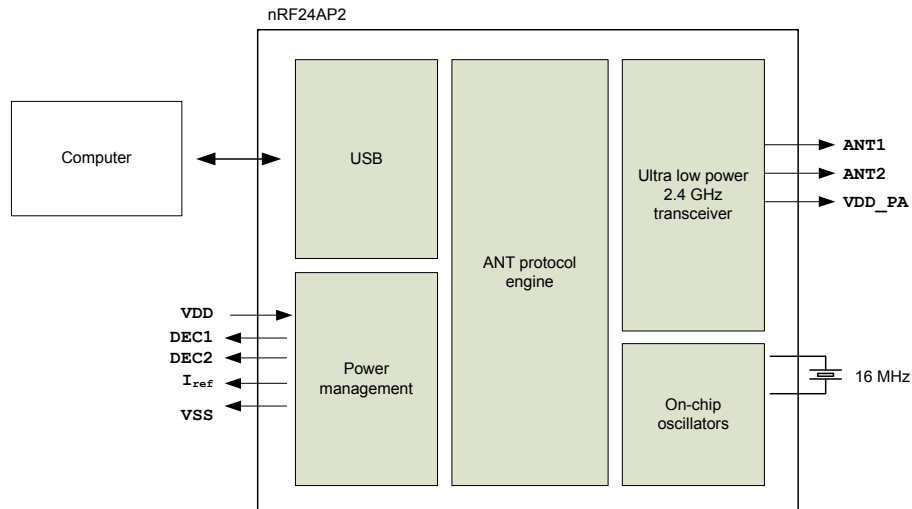

Figure 2. Block diagram of nRF24AP2 solution

To find more information about each block in the diagram, see [Table 1](#).

Name	Reference
RF transceiver	Chapter 3 on page 12
ANT protocol engine	Chapter 4 on page 13
USB interfaces	Chapter 5 on page 21
On-chip oscillators	Chapter 6 on page 30
Power management	Chapter 8 on page 33

Table 1. Block diagram cross references

2.3 Pin Assignments

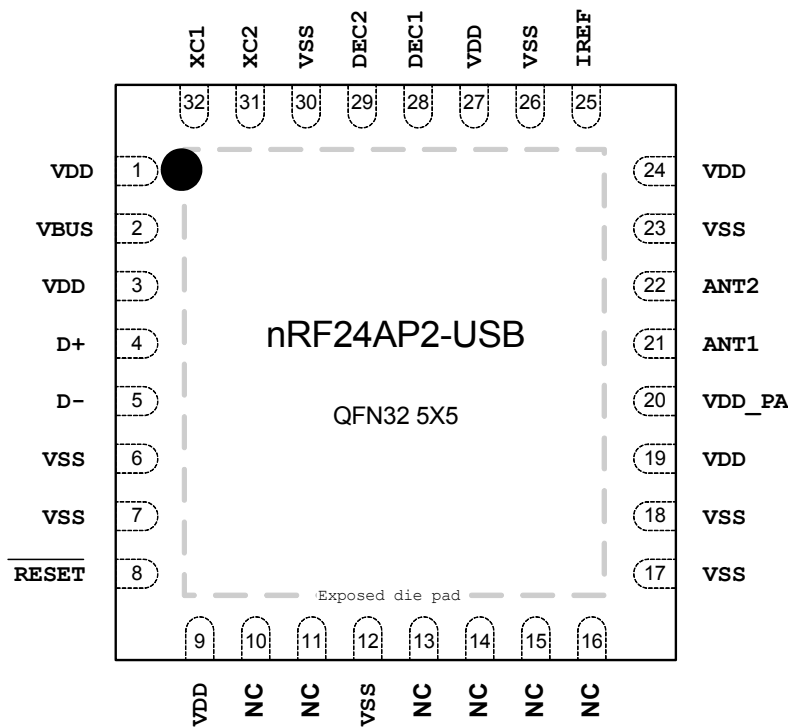

Figure 3. nRF24AP2-USB pin assignment (top view) for a QFN32 5x5 mm package

2.4 Pin Functions

Pin	Name	Type	Description
21, 22	ANT1, ANT2	RF	Differential antenna connection (TX and RX)
5, 4	D-, D+	Digital I/O	Differential USB connection
28, 29	DEC1, DEC2	Power	Power supply outputs for de-coupling purposes
25	IREF	Analog Input	Device reference current output. To be connected to reference resistor on PCB
10, 11, 13, 14, 15, 16	NC	NC	Not connected
8	RESET	Digital Input	Reset, active low. Connect to VDD if not used
2	VBUS	Power	USB power supply
1, 3, 9, 19, 24, 27	VDD	Power	Alternative power supply pins. The VDD pins must always be connected and de-coupled externally.
20	VDD_PA	Power Output	Power supply output (+1.8V) for on-chip RF Power amplifier
6, 7, 12, 17, 18, 23, 26, 30	VSS	Power	Ground (0V)
32, 31	XC1, XC2	Analog Input	Connection for 16 MHz crystal
	Exposed die pad	Power/heat relief	Not connected

Table 2. nRF24AP2-USB pin functions

2.4.1 Power supply pins

vBUS and **vss** are the power supply and ground pins. The nRF24AP2-USB can operate from a single power supply.

The nRF24AP2-USB contains an on-chip regulator that produces +3.3V on the **vDD** pins, from the **vBUS** supply line (4.0 – 5.25V). Alternatively, the **vBUS** pin can be left open and the **vDD** pins may be fed from an external 3.3V supply. In this case, the on-chip 3.3V regulator is switched off.

2.4.2 Reset pin

The **RESET** pin provides an optional reset when the nRF24AP2-USB is placed in a system that has a master reset source, this pin is not needed for normal application. Pull **RESET** pin low for minimum 0.2 μ s and return to high, this will reset the nRF24AP2-USB to the default state. Connect **RESET** pin to **vDD** if not used in the application.

3 RF transceiver

All transceiver operations are controlled solely by the ANT protocol stack. Configuration of the ANT protocol stack occurs through a serial interface by issuing ANT commands to nRF24AP2-USB.

3.1 Features

Features of the RF transceiver include:

- General
 - Worldwide 2.4 GHz ISM band operation
 - Common antenna interface in transmit and receive
 - GFSK modulation
 - 1 Mbps on air data rate
- Transmitter
 - Programmable output power: 0, -6, -12 or -18 dBm
- Receiver
 - Integrated channel filters
 - -85 dBm sensitivity
- RF Synthesizer
 - Fully integrated synthesizer
 - 1 MHz frequency programming resolution
 - 78 RF channels in the 2.4 GHz ISM band
 - Accepts low cost ± 50 ppm 16 MHz crystal
 - 1 MHz non-overlapping channel spacing

3.2 Block diagram

[Figure 4. on page 12](#) shows a block diagram of the RF transceiver in nRF24AP2-USB.

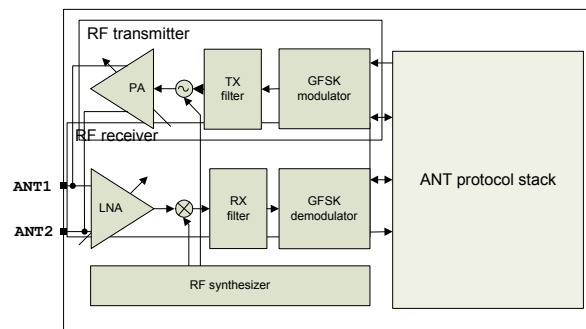

Figure 4. Internal circuitry of RF transceiver relative to ANT

4 ANT overview

The ANT protocol has been engineered for simplicity and efficiency. In operation, this results in ultra-low power consumption, maximized battery life, a minimal burden on system resources, simpler network designs and lower implementation costs.

4.1 Block diagram

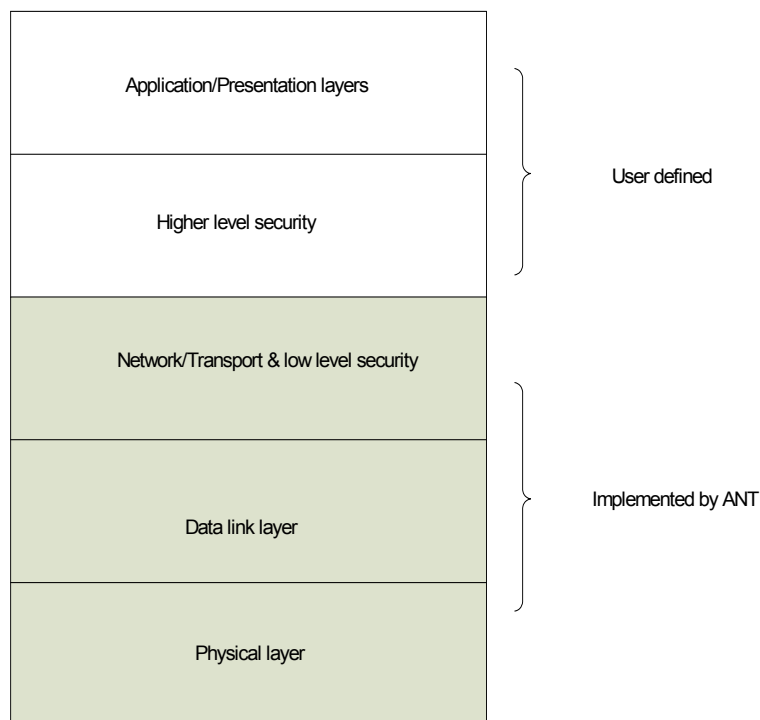

Figure 5. OSI layer model of ANT protocol stack

ANT provides carefree handling of the Physical, Data Link, Network, and Transport OSI layers. Please see [Figure 5. on page 13](#). In addition, it incorporates key, low-level security features that form the foundation for user-defined, sophisticated, network-security implementations. ANT ensures adequate user control while considerably easing the computational burden, by providing a simple yet effective wireless networking solution.

4.2 Functional description

A brief overview of the ANT concept is presented here for convenience. A complete description of the ANT protocol is found in the document *ANT Message Protocol and Usage* available at www.nordicsemi.com or www.thisisant.com.

4.2.1 ANT nodes

All ANT networks are built up of nodes. See the ANT node represented in [Figure 6. on page 14](#). A node can be anything from a simple sensor to a complex, collection unit like a watch or computer. Common to all nodes is that they contain an ANT engine (nRF24AP2) handling all connectivity to other nodes and a host processor handling the application features. nRF24AP2 interfaces to the host processor through a serial interface, and all configuration and control are performed using a simple command library.

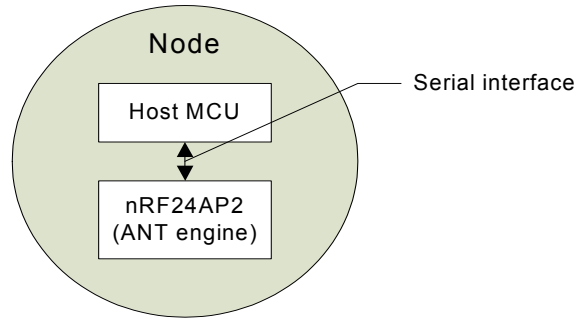

Figure 6. The ANT node

4.2.2 ANT channels

nRF24AP2 can establish one or up to eight logic channels, called ANT channels, to other ANT nodes. The number of ANT channels available depends on the nRF24AP2 variant being used.

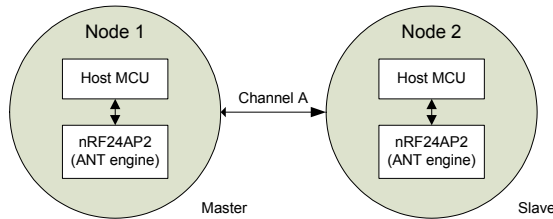

Figure 7. ANT nodes and the channel between them

The simplest ANT channel is called an independent channel and consists of two nodes, one acting as master, the other as slave for this channel. For each ANT channel opened, nRF24AP2 will set up and manage a synchronous wireless link, exchanging data packets with other ANT nodes at preset time intervals called channel periods. See [Figure 8. on page 15](#). The master controls the timing of a channel, that is to say, it will always initiate communication between the nodes. The slave locks on to the timing set by the master, receives the transmissions from the master and can then (if configured so) send acknowledge and/or data (if any) back to the master.

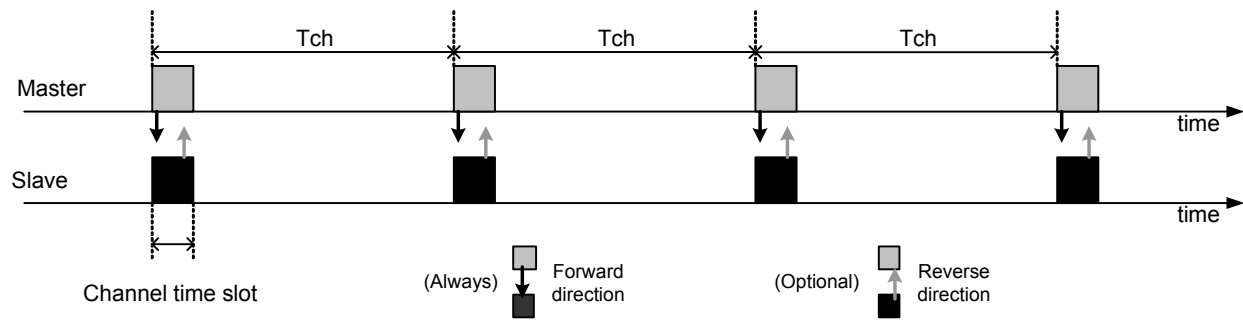

Figure 8. Channel communication showing forward and reverse directions. Not to scale

At each time slot an ANT channel can transfer user data (8 bytes) both ways as simple broadcasts, broadcast with acknowledgement from the receiver, or transfer data as bursts (this will extend the time slot used) to accommodate transfer of larger blocks of user data. The total available payload bandwidth (20 kbps) in an ANT node is shared between active ANT channels through a Time Division Multiple Access (TDMA) scheme. If a channel time slot comes up, but there is no new data from the master, the master will still send the last packet to keep the timing of the channel and enable the slave to send data back if needed.

Each ANT channel available in the nRF24AP2 can for example be configured as a simple unidirectional (broadcast), or bi-directional independent channel; or as a more complex, shared channel where a master interfaces to multiple slaves (1:N topologies). Please see the *ANT Message Protocol and Usage* document for further details on shared ANT channels.

4.2.3 ANT channel configuration

Unique to ANT is that the setup of each ANT channel is independent from all the other ANT channels in the network, including other channels in the same node. This means that one ANT node can act as master on one ANT channel while being a slave to another. Since there is no overall 'network master' present in ANT networks, ANT allows you to configure and run each ANT channel solely based on the needs of the nodes on that channel. Search- and pairing algorithms in ANT let you easily set up and shut down ANT channels in an ad-hoc fashion. This gives you ultimate flexibility in adjusting ANT channel parameters like data rate and latency versus power consumption. Moreover, you only make the network as complex as it needs to be at any given time. In order for two ANT nodes to set up an ANT channel, they must share a common channel configuration and channel ID. The necessary configuration parameters are summarized in [Table 3. on page 16.](#)

Parameter	Comment
Channel configuration	
Channel period	Time interval between data exchanges on this channel (5.2 ms - 2 s)
RF frequencies	Which of the 78 available RF frequencies is used by this channel
Channel type	Bi-directional slave, bi-directional master, shared bi-directional slave, Slave Receive only
Network type	Decides if this ANT channel is going to be generally accessible (public) to all ANT nodes, or if it shall limit its connectivity to devices belonging to a managed or private network
Channel ID	
Transmission type	1 byte – Identifying characteristics of the transmission, can for instance contain codes on how payload is to be interpreted
Device type	1 byte - ID to identify the device type of the channel master (Ex: heartrate belt, temperature sensor etc.)
Device number	2 byte - Unique ID for this channel

Table 3. ANT channel ID

The channel configuration parameters are static system parameters that must match in the master and slave, and the channel ID is included in all transmissions identifying the two nodes for each other. For in-depth details on each parameter please refer to *ANT Message Protocol and Usage*.

Network

In addition to setting the content of the channel ID, which is the primary ID of an ANT node, ANT nodes can limit their connectivity to a selection of other ANT nodes by defining a network for each ANT channel. The limited access to certain networks is managed through unique network keys

The defined ANT networks are:

1. **Public networks:** These are open ANT networks with no limitation on connectivity. All ANT nodes sharing the same channel configuration (by design or by accident) will be able to connect. This is the default setting in nRF24AP2.
2. **Managed networks:** These are ANT networks managed by special interest groups or alliances. An example is the ANT+ alliance for sport and wellness products. To join the ANT+ alliance, please visit www.thisisant.com. By joining the ANT+ alliance and complying with the ANT+ device profiles set by the alliance, you achieve two goals:
 - ▶ Limited connectivity: Only other ANT+ compliant devices can connect on this channel.
 - ▶ Interoperability: Your node can connect to ANT+ compliant products from other vendors.
3. **Private networks:** Your own protected networks, and no other devices, will be able to connect to your ANT nodes unless you share the network key with someone outside the network. Please note that this requires purchase of a unique network key from ANT, see www.thisisant.com.

Since the network parameter can be chosen independently for each ANT channel, one ANT node can have up to eight ANT channels, operating on different networks at the same time.

Note: The network parameter has no impact on the network topologies you can build. It is merely a tool to protect your ANT network and prevent accidental or deliberate access from other ANT nodes.

Channel ID, search and pairing

The primary parameters which two ANT nodes use to identify each other make up the **channel ID**. Once an ANT channel is established, the **channel ID parameters** must of course match; but they don't have to be known by both nodes (pre-configured) to be able to establish an ANT channel.

When an nRF24AP2 configured as a master (set in channel type) opens an ANT channel, it will broadcast its entire **channel ID**. Hence you must configure all three **channel ID parameters** before opening an ANT channel as a master.

On the other hand, in a slave you can configure nRF24AP2 to search for and connect with both known and unknown masters. To connect with a known master you must configure the **Transmission type**, **Device type** and **Device number** in nRF24AP2 before opening the ANT channel.

You can also configure the nRF24AP2 to conduct wild-card searches on one or more of the three parameters in the **channel ID** to enable it to pair up with unknown masters. You can for instance set only the **Device type** of the masters you want to link up with, and set wild cards on the **Transmission type** and **Device number**. If a new master with a matching **Device type** is found, the slave device will connect and store the unknown parts of the **channel ID**. The new parts of the **channel ID** can then be stored in the host MCU to enable specific searches for this master later.

4.2.4 Proximity search

When using the basic search and pairing algorithm a slave will automatically identify and connect to the first master it finds matching the search criteria. In areas where you either have a high density of similar master nodes or high density of independent ANT networks, there is always the chance that multiple masters are found within the coverage area. This presents the risk that it is not the master you want to connect to that is found first. The proximity search feature in ANT designates 'bins' of proximity from 1 (closest) to 10 (furthest) as shown in [Figure 9. on page 17](#).

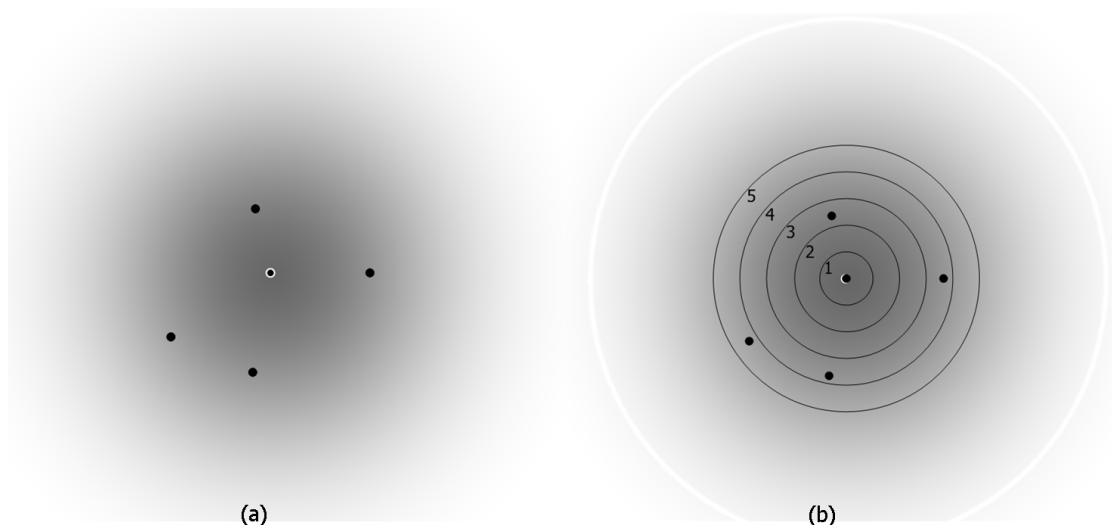

Figure 9. Standard search (a), Proximity search (b), showing bins 1-5 (of maximum 10)

This 'binning' enables you to further control your search, for example by only accepting the master that is closest (only accepting masters that fall in bin 1-2). This makes it easy for a user to pair up network nodes and prevent accidental connection to nodes possibly belonging to another network close by.

4.2.5 Continuous scanning mode

Continuous scanning mode allows for fully asynchronous communication between an ANT node using continuous scanning mode, and any other ANT node using a standard master channel. This has two main advantages over only using standard ANT channels. The first is that the latency to initiate communication with the scanning node is reduced to zero and every message sent by a master channel in proximity will be received by the scanning device. Secondly, the requirement to maintain communication for the purpose of synchronization while in proximity is removed. This means that it is possible for nodes to come and go very quickly or to turn off for long periods of time in between communication events. This saves power on the transmitting node.

The disadvantage of continuous scanning mode is that it consumes much more power than standard ANT channels. Therefore, continuous scanning mode will typically be used only on devices that are plugged in and not mobile such as a computer (USB dongle). Another disadvantage is that a node in scanning mode can no longer be configured to have discoverable master channels because scanning mode disables standard ANT channel functionality. It is worth noting that two ANT nodes in scanning mode cannot communicate with one another because neither will be able to spontaneously generate communication.

Standard ANT channels are recommended over scanning channels, even in dynamic systems where devices are coming and going. This is because scanning channels are not recommended for a mobile network, which is the primary use case for ANT. Scanning channels will typically be used in statically located networks where the scanning channel node is plugged in and not mobile.

4.2.6 ANT network topologies

By combining ANT channels with different features depending on local needs, you can build anything from very simple peer-to-peer links and star networks to complex networks as shown in [Figure 10. on page 19](#).

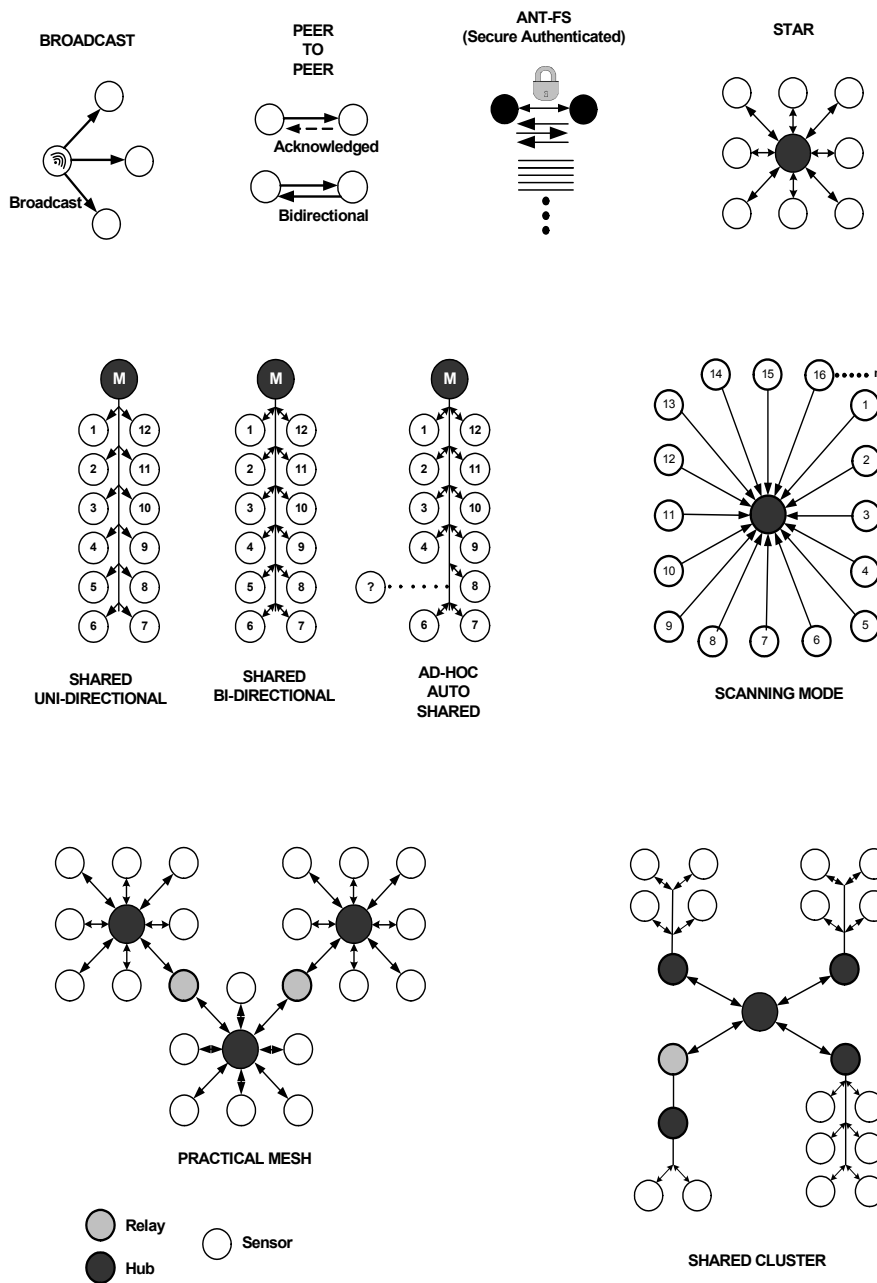

Figure 10. Network topology examples supported by ANT

4.2.7 ANT message protocol

The host microcontroller handles all the configuration and control of the various ANT node and channel parameters in nRF24AP2 over a simple serial interface, by using the command library. See the document *ANT Message Protocol and Usage* for further details on the command library.

Class	Type	Commands in ANT command library	Reply	From
Config. messages	Unassign Channel	ANT_UnassignChannel()	Yes	Host
	Assign Channel	ANT_AssignChannel()	Yes	Host
	Channel ID	ANT_SetChannelId()	Yes	Host
	Channel Period	ANT_SetChannelPeriod()	Yes	Host
	Search Timeout	ANT_SetChannelSearchTimeout()	Yes	Host
	Channel RF Frequency	ANT_SetChannelRFFreq()	Yes	Host
	Set Network	ANT_SetNetworkKey()	Yes	Host
	Transmit Power	ANT_SetTransmitPower()	Yes	Host
	ID List Add	ANT_AddChannelID()	Yes	Host
	ID List Config	ANT_ConfigList()	Yes	Host
	Channel Transmit Power	ANT_SetChannelTxPower()	Yes	Host
	Low Priority Search Timeout	ANT_SetLowPriorityChannelSearchTimeout()	Yes	Host
	Enable Ext RX Mesgs	ANT_RxExtMesgsEnable()	Yes	Host
	Frequency Agility	ANT_ConfigFrequencyAgility()	Yes	Host
	Proximity Search	ANT_SetProximitySearch()	Yes	Host
Notifications	Startup Message	→ ResponseFunc(-, 0x6F)	-	ANT
Control Messages	SystemReset	ANT_ResetSystem()	No	Host
	Open Channel	ANT_OpenChannel()	Yes	Host
	Close Channel	ANT_CloseChannel()	Yes	Host
	Open Rx Scan Mode	ANT_OpenRxScanMode()	Yes	Host
	Request Message	ANT_RequestMessage()	Yes	Host
Data Messages	Broadcast Data	ANT_SendBroadcastData() → ChannelEventFunc(Chan, EV)	No	Host/ ANT
	Acknowledge Data	ANT_SendAcknowledgedData() → ChannelEventFunc(Chan, EV)	No	Host/ ANT
	Burst Transfer Data	ANT_SendBurstTransferPacket() → ChannelEventFunc(Chan, EV)	No	Host/ ANT
Channel Event Messages	Channel Response/Event	→ ChannelEventFunc(Chan, MessageCode) or → ResponseFunc(Chan, MsgID)	-	ANT
Requested Response Messages	Channel Status	→ ResponseFunc(Chan, 0x52)	-	ANT
	Channel ID	→ ResponseFunc(Chan, 0x51)	-	ANT
	ANT Version	→ ResponseFunc(Chan, 0x51)	-	ANT
	Capabilities	→ ResponseFunc(Chan, 0x3E)	-	ANT
Test Mode	CW Init	ANT_InitCWTestMode()	Yes	Host
	CW Test	ANT_SetCWTestMode()	Yes	Host
Ext Data messages	Extended Broadcast Data	ANT_SendExtBroadcastData() ^a → ChannelEventFunc(Chan, EV)	No	Host
	Extended Ack. Data	ANT_SendExtAcknowledgedData() ^a → ChannelEventFunc(Chan, EV)	No	Host
	Extended Burst Data	ANT_SendExtBurstTransferPacket() ^a → ChannelEventFunc(Chan, EV)	No	Host

a. nRF24AP2 does not send these ChannelEventFunctions() to the host. nRF24AP2 will send extended messages by appending the additional bytes to standard broadcast, acknowledged and burst data.

Table 4. ANT message summary supported by nRF24AP2

5 Host interface

The nRF24AP2-USB has a USB v2.0 compliant host interface. This enables direct connection from the nRF24AP2-USB to a computer or hubs in other USB enabled equipment. Together with the command libraries and USB drivers available from ANT the nRF24AP2-USB enables ANT connectivity for applications in computers and other advanced hosts.

5.1 Features

USB serial interface of nRF24AP2-USB:

- Serial interface engine:
 - USB v2.0 compliant
 - On-chip pull-up resistor on D+
- Two control endpoints and two bulk endpoints
- Suspend and resume power management functions
- USB drivers and ANT command libraries supported by ANT

The following USB features are necessary to declare when your product undergoes USB compliance testing:

- Full speed peripheral
- Microcontroller with USB drivers on same chip
- Bus powered
- No remote wakeup

5.2 Block diagram

[Figure 11](#) shows a USB block with external signals **VBUS**, **D+**, **D-**, **GND**, on-chip pull up resistor on **D+** on one side and connection to the RF transceiver on the other.

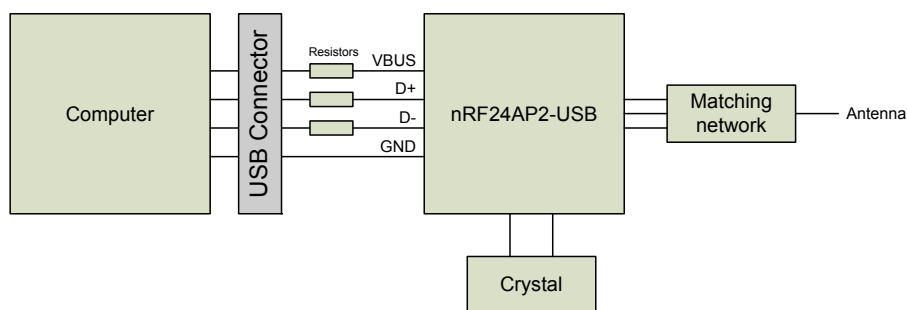

Note: The serial resistors on VBUS, D+ and D- are for ESD protection and USB v2.0 compliance

Figure 11. USB block connected to ANT engine

5.3 Functional description

When the nRF24AP2-USB is plugged into a USB the first thing that needs to take place is for the nRF24AP2-USB to identify itself for the USB hub. This process is called enumeration and is handled automatically by the nRF24AP2-USB. Once the device is enumerated, applications on the host can access the nRF24AP2-USB using ANT command libraries.

This section outlines the enumeration process, user configurable USB parameters, and message exchanges that take place on the nRF24AP2-USB host interface.

5.3.1 Physical USB connection

The physical connection between nRF24AP2-USB and the host must follow the USB standard v2.0 (for instance, use USB approved connectors) in order for your nRF24AP2-USB based application to go through USB compliance testing.

5.3.2 USB enumeration

The USB enumeration process is handled by the nRF24AP2-USB. During the enumeration the host reads out the USB descriptors and strings to determine which device has been connected to the bus. After the host has received the parameters it will then assign the device an address and allowing it to transfer data on the bus.

A typical enumeration process consists of the following steps:

1. The host detects a new device on the bus via the pull up resistor on D+.
2. The host issues a reset to place the nRF24AP2-USB to the default state. This will enable the device to respond to the default address zero requests.
3. The host requests the Device Descriptor on address 0.
4. The host issues another bus reset.
5. The host issues a set address command, placing the nRF24AP2-USB in an addressed state.
6. The host requests the Device Descriptor again.
7. The host requests the Configuration, Interface and Endpoint Descriptors.
8. The host requests the String Descriptors.

After the enumeration process the nRF24AP2-USB can transfer ANT messages on the bus. A complete summary of ANT messages supported are listed in [Table 4. on page 20](#).

5.3.3 USB descriptors

The nRF24AP2-USB has a set of USB descriptors which describe to the host information about manufacturer, product, USB version, the number of endpoints and their types.

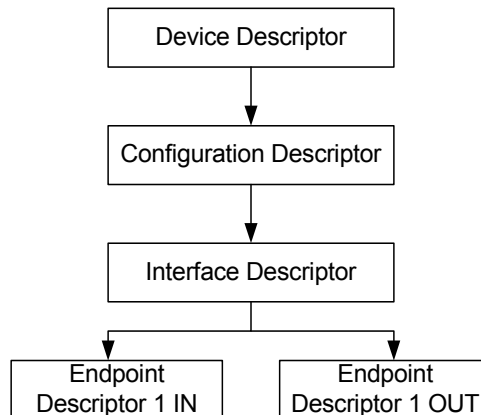

Figure 12. Organization of USB descriptors

The device descriptor contains basic information about the device such as the supported USB version, maximum packet size, vendor and product IDs.

Field	Notes	Value	Description
bLength		0x12	18
bDescriptorType		0x01	DEVICE
bcdUSB		0x0200	2.0
bDeviceClass		0x00	Class defined at interface level
bDeviceSubClass		0x00	Subclass defined at interface level
bDeviceProtocol		0x00	None
bMaxPacketSize0		0x20	32
idVendor	a	0x0FCF	Dynastream Innovations, Inc.
idProduct	a	0x1008	0x1008
bcdDevice		0x0100	1.0
iManufacturer		0x01	1
iProduct		0x02	2
iSerialNumber		0x03	3
bNumConfigurations		0x01	1

a. These fields can be customized with your own value

Table 5. Device descriptors

The configuration descriptor specifies how the device is powered, the maximum power consumption, and the number of interfaces used.

Field	Notes	Value	Description
bLength		0x09	Valid
bDescriptorType		0x02	CONFIGURATION
wTotalLength		0x0020	32 bytes
bNumInterface		0x01	1
bConfigurationValue		0x01	1
iConfiguration		0x02	2
bmAttributes. Reserved		0x00	Zero
bmAttributes. RemoteWakeup		0x0	Not supported
bmAttributes. SelfPowered		0x0	No, Bus powered
bmAttributes. Reserved7		0x1	One
bMaxPower		0x32	100 mA

Table 6. Configuration descriptor

The interface descriptor contains information about the number of endpoints and their class.

Field	Notes	Value	Description
bLength		0x09	Valid
bDescriptorType		0x04	INTERFACE
bInterfaceNumber		0x00	0
bAlternateSetting		0x00	0
bNumEndpoints		0x02	2
bInterfaceClass		0xFF	Vendor-specific
bInterfaceSubClass		0x00	Vendor-specific
bInterfaceProtocol		0x00	None
iInterface		0x02	2

Table 7. Interface descriptor

Endpoint descriptors contain information about the transfer type, interval and the packet size. The host will use the information to decide on the requirements for the bus. The nRF24AP2-USB uses two endpoints for communication with the host, one configured as IN and the other as OUT.

Field	Notes	Value	Description
bLength		0x07	Valid
bDescriptorType		0x05	ENDPOINT
bEndpointAddress		0x81	1 IN
bmAttributes. TransferType		0x2	Bulk
bmAttributes. Reserved		0x00	Zero
wMaxPacketSize		0x0040	64 bytes
bInterval		0x01	Ignored for full speed, Bulk endpoints

Table 8. Endpoint descriptor 1 IN

Field	Notes	Value	Description
bLength		0x07	Valid
bDescriptorType		0x05	ENDPOINT
bEndpointAddress		0x01	1 OUT
bmAttributes. TransferType		0x2	Bulk
bmAttributes. Reserved		0x00	Zero
wMaxPacketSize		0x0040	64 bytes
bInterval		0x01	Ignored for full speed, Bulk endpoints

Table 9. Endpoint descriptor 1 OUT

5.3.4 String descriptors

String descriptors provide information about the manufacturer, product and serial number for the nRF24AP2-USB. These strings can be modified, see section [5.3.5 on page 25](#).

String Index 0 returns a list of supported languages.

Field	Notes	Value	Description
bLength		0x04	4
bDescriptorType		0x03	STRING
wLANGID[0]		0x0409	English (US)

Table 10. String index 0 (language identifier)

Field	Notes	Value	Description
bLength		0x30	48
bDescriptorType		0x03	STRING
bString	a	"Dynastream Innovations"	

a. This field can be customized with your own manufacturer string

Table 11. String index 1 (manufacturer string)

Field	Notes	Value	Description
bLength		0x1E	30
bDescriptorType		0x03	STRING
bString	a	"ANT USBStick2"	

a. This field can be customized with your own product string

Table 12. String index 2 (product string)

Field	Notes	Value	Description
bLength		0x2A	42
bDescriptorType		0x03	STRING
bString	a	"123"	

a. This field can be customized with your own serial number

Table 13. String index 3 (serial number string)

5.3.5 Customize descriptors

The nRF24AP2-USB is programmed with default VID/PID values which allow it to function with the drivers and libraries provided by ANT. However, it is possible to customize the nRF24AP2-USB. You can customize the following values and string descriptors:

- Vendor ID (VID)
- Product ID (PID)
- Manufacturer string
- Product string
- Serial number

Use the `Set_Descriptor_String(0xC7)` command to configure USB descriptor strings. This command is an extension to the ANT command interface and is sent in the same manner as the other ANT serial commands. The descriptor strings can be set up to three times. See the document *ANT Message Protocol and Usage* for further details on the command library.

Note: Do not remove power supply while updating the VID, PID or USB descriptors.

5.3.6 Control transfer

Control transfers are used for all commands and queries during the USB device enumeration process. The nRF24AP2-USB allows a maximum data packet size of 32 bytes for the control transfers. All control transfers can have up to three stages, and are handled automatically by the nRF24AP2-USB.

5.3.6.1 Control write transfer



Figure 13. Setup stage

The setup stage starts with a SETUP token packet, followed by a DATA packet detailing the type of request. Finally an ACK handshake packet is sent back by the nRF24AP2-USB if the setup data has been received correctly, otherwise nothing is sent back.

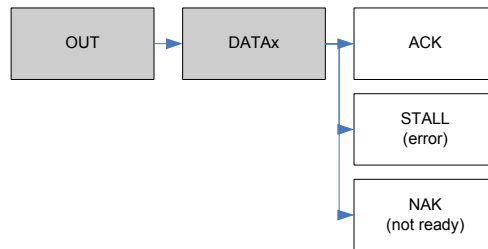

Figure 14. Data stage (optional)

When the request indicates that the host wants to send control data, the data stage will be made up of one or more OUT transfers. Each OUT transfer will start with an OUT token packet followed by a DATA packet. The nRF24AP2-USB will reply with an ACK handshake packet if everything was received correctly. A NAK will be returned if the previous packet from the host is still being processed. If any part of the token or data packet was corrupted or missing, nothing will be sent back. A STALL will be returned if the token and data were received but another error occurred.

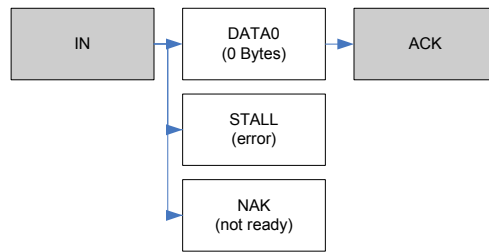

Figure 15. Status stage

The status stage is used to verify the status of the overall request. For a control write transfer the status stage will start with an IN token packet. The nRF24AP2-USB will reply with a DATA packet of zero length if the overall request was successful. A STALL will be returned if an error occurred at any point during the processing of the transfer. A NAK will be returned if the nRF24AP2-USB is still busy processing the transfer. Finally the host will send an ACK handshake packet to indicate that it received the status.

5.3.6.2 Control read transfer



Figure 16. Setup stage

The setup stage starts with a SETUP token packet, followed by a DATA packet detailing the type of request. Finally an ACK handshake packet is sent back by the nRF24AP2-USB if the setup data has been received correctly, otherwise nothing is sent back.

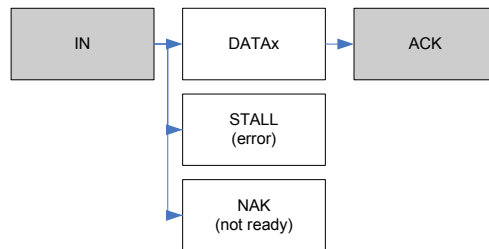

Figure 17. Data stage (optional)

When the request indicates that the host wants to receive control data, the data stage will be made up of one or more IN transfers. Each IN transfer will start with an IN token packet. The nRF24AP2-USB can reply with a DATA packet, a STALL indicating an error has occurred or a NAK indicating that the data is not

yet ready. Finally, when the DATA is received successfully by the host it will send an ACK handshake packet.

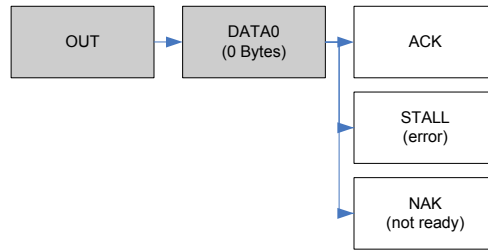

Figure 18. Status stage

For a control read transfer the status stage is used by the host to acknowledge that it has received the data successfully. The status stage will start with an OUT token packet followed by a DATA packet of zero length. The nRF24AP2-USB will reply with an ACK handshake packet if it received the status packets successfully. A STALL will be returned if an error occurred at any point during the processing of the transfer. A NAK will be returned if the nRF24AP2-USB is busy and requires the host to repeat the status stage.

5.3.7 Host Command flow

All other communication between the host and nRF24AP2 USB will be handled through USB drivers and libraries available from ANT. These USB libraries interact with the device through two bulk endpoints (EP1IN and EP1OUT). The use of the host interface is documented in *ANT Message Protocol and Usage* which is available as a PDF file from www.nordicsemi.com and www.thisisant.com. The serial messages detailed in that document are passed between the host and the nRF24AP2-USB inside the data packet portion of USB bulk transfers.

USB parameters	Value
VID (Vendor Identification)	0x0FCF
PID (Product Identification)	0x1008
IN endpoint address	0x81
OUT endpoint address	0x01

Table 14. Driver/application USB parameters for communication with nRF24 AP2-USB

5.3.7.1 Bulk transfers

Bulk transfers will be used to transport the serial messages specified by the ANT command interface. The nRF24AP2-USB supports a maximum bulk data packet size of 64 bytes.

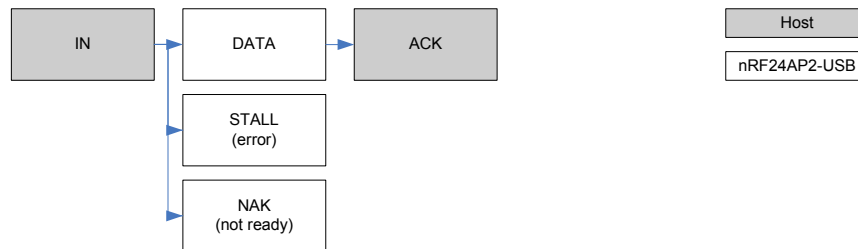

Figure 19. Bulk IN transfer

When the host is ready to receive bulk data it will send an IN token packet to the IN endpoint (0x81). The nRF24AP2-USB will either send a DATA packet if one is ready, send a STALL if an error occurred, send a NAK if no data is ready yet or do nothing if the IN token was not received properly. Finally the host will send an ACK handshake packet if it successfully received the DATA packet.

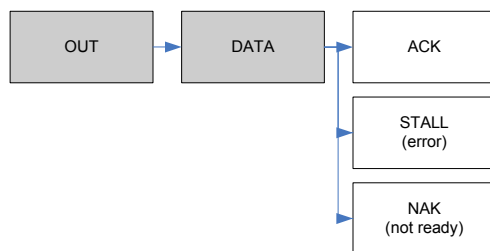

Figure 20. Bulk OUT transfer

When the host wants to send bulk data to the nRF24AP2-USB it will send an OUT token packet to the OUT endpoint (0x01). This will be followed by a DATA packet containing the bulk data. If the nRF24AP2-USB received the data successfully it will return an ACK handshaking packet. If an error occurred during processing, the nRF24AP2-USB will return a STALL. If the nRF24AP2-USB is still busy processing the previous DATA packet, a NAK will be returned. If any part of the OUT token or DATA packet was corrupted or missing the nRF24AP2-USB will do nothing.

5.3.7.2 Bulk transfer example

The libraries available from ANT contain all the supported messages to configure and use the nRF24AP2-USB. [Figure 21](#) shows an example of a serial message passing between the host and device.

In this example the host issues an ANT_RequestMessage() in the data packet to read the ANT version of the device. We have included hexadecimal values to help you should you need to debug the host serial interface.

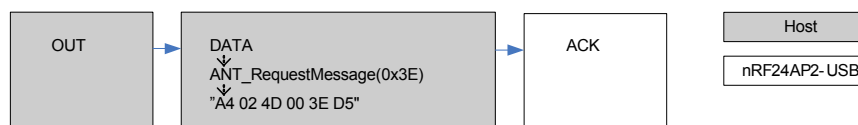

Figure 21. Example of OUT transfer (with varying level of detail)

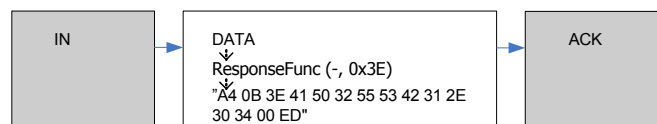

Figure 22. Example of IN transfer (with varying level of detail)

6 On-chip oscillator

In order to provide the necessary clocks for the ANT protocol stack, nRF24AP2 contains one high frequency oscillator used by the RF transceiver. The high frequency clock source must be a 16 MHz crystal oscillator.

6.1 Features

- Low-power, amplitude regulated 16 MHz crystal oscillator

6.2 Block diagram

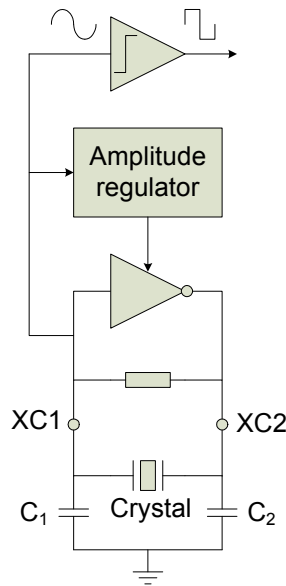

Figure 23. Block diagram of 16 MHz crystal oscillator

6.3 Functional description

6.3.1 16 MHz crystal oscillator

The 16 MHz crystal oscillator is designed to be used with an AT-cut quartz crystal in parallel resonant mode. To achieve correct oscillation frequency it is very important that the load capacitance matches the specification in the crystal datasheet. The load capacitance is the total capacitance from the perspective of the crystal across its terminals:

$$C_{LOAD} = \frac{C_1' \cdot C_2'}{C_1' + C_2'}$$

$$C_1' = C_1 + C_{PCB1} + C_{PIN}$$

$$C_2' = C_2 + C_{PCB2} + C_{PIN}$$

C_1 and C_2 are ceramic SMD capacitors connected between each crystal terminal and VSS. C_{PCB1} and C_{PCB2} are stray capacitances on the PCB. C_{PIN} is the input capacitance on the **xc1** and **xc2** pins of nRF24AP2 (typically 1pF). C_1 and C_2 should be of the same value, or as close as possible.

To ensure a functional radio link the frequency accuracy must be ± 50 ppm or better. The initial tolerance of the crystal, drift over temperature, aging and frequency pulling due to incorrect load capacitance must all be taken into account. For reliable operation the crystal load capacitance, shunt capacitance, equivalent series resistance (ESR) and drive level must comply with the specifications in [Table 17. on page 34](#). It is recommended to use a crystal with lower than maximum ESR if the load capacitance and/or shunt capacitance is high. This will give faster start-up and lower current consumption.

6.3.2 External 16 MHz clock

nRF24AP2 may be used with an external 16 MHz clock applied to the **xc1** pin. The input signal must be analog, coming from the crystal oscillator of a microcontroller, for example. An input amplitude of 0.8V peak-to-peak or higher is recommended to achieve low current consumption and a good signal-to-noise ratio. The DC level is not important as long as the applied signal never rises above VDD or drops below VSS. The **xc1** pin will load the microcontroller's crystal with approximately 1pF in addition to PCB routing. **xc2** shall not be connected.

Note: A frequency accuracy of ± 50 ppm or better is required to get device performance as outlined in chapter [8 on page 33](#).

7 Operating conditions

Symbol	Parameter (condition)	Notes	Min.	Typ.	Max.	Units
VBUS	Supply voltage		4.0	5	5.25	V
VDD	Alternative supply voltage		3.05	3.27	3.5	V
TEMP	Operating Temperature		-40	+27	+85	°C

Table 15. Operating conditions

Symbol	Parameter (condition)	Notes	Min.	Typ.	Max.	Unit
16 MHz crystal						
f_{NOM}	Nominal frequency (parallel resonant)			16.000		MHz
f_{TOL}	Frequency tolerance	a			±50	ppm
C_L	Load capacitance			9	16	pF
C_0	Shunt capacitance			3	7	pF
ESR	Equivalent series resistance			50	100	Ω
P_D	Drive level				100	μW
Bias resistor (IREF pin to GND)						
Rref	Resistance			22		kΩ
Rrefacc	Tolerance				1	%

a. Includes initial accuracy, stability over temperature, aging and frequency pulling due to incorrect load capacitance

Table 16. External circuitry specification

8 Electrical specifications

This section contains electrical and timing specifications.

Conditions: VDD = 3.0V, T_A = -40°C to +85°C (unless otherwise noted)

Symbol	Parameter (condition)	Notes	Min.	Typ.	Max.	Units
General RF conditions						
f _{OP}	Operating frequency	a	2400	2403-2480	2483.5	MHz
PLL _{res}	PLL Programming resolution			1		MHz
f _{XTAL}	Crystal frequency			16		MHz
Δf	Frequency deviation			±160		kHz
R _{GFSK}	Air data rate	b		1000		kbps
F _{CHANNEL}	Non-overlapping channel spacing	c		1		MHz
Transmitter operation						
P _{RF}	Maximum output power	d		0	+4	dBm
P _{RFC}	RF power control range		16	18	20	dB
P _{RFcr}	RF power accuracy				±4	dB
P _{BW1}	20dB bandwidth for modulated carrier			950	1100	kHz
P _{RF1.1}	1 st Adjacent Channel Transmit Power 1 MHz				-20	dBc
P _{RF2.1}	2 nd Adjacent Channel Transmit Power 2 MHz				-40	dBc
Receiver operation						
RX _{MAX}	Maximum received signal at < 0.1% BER			0		dBm
RX _{SENS}	Sensitivity (0.1% BER)			-85		dBm
RX selectivity according to ETSI EN 300 440-1 V1.3.1 (2001-09) page 27						
C/I _{CO}	C/I co-channel			9		dBc
C/I _{1ST}	1 st ACS, C/I 1 MHz			8		dBc
C/I _{2ND}	2 nd ACS, C/I 2 MHz			-20		dBc
C/I _{3RD}	3 rd ACS, C/I 3 MHz			-30		dBc
C/I _{Nth}	N th ACS, C/I f _i > 6 MHz			-40		dBc
C/I _{Nth}	N th ACS, C/I f _i > 25 MHz			-47		dBc
RX selectivity with nRF24AP2 equal modulation on interfering signal (P_{in} = -67dBm for wanted signal)						
C/I _{CO}	C/I co-channel			12		dBc
C/I _{1ST}	1 st ACS, C/I 1 MHz			8		dBc
C/I _{2ND}	2 nd ACS, C/I 2 MHz			-21		dBc
C/I _{3RD}	3 rd ACS, C/I 3 MHz			-30		dBc
C/I _{Nth}	N th ACS, C/I f _i > 6 MHz			-40		dBc
C/I _{Nth}	N th ACS, C/I f _i > 25 MHz			-50		dBc
RX intermodulation performance in line with Bluetooth specification version 2.0, 4th November 2004, page 42						
P _{IM(3)}	Input power of IM interferers at 3 and 6 MHz distance from wanted signal	e		-36		dBm

Symbol	Parameter (condition)	Notes	Min.	Typ.	Max.	Units
P_IM(4)	Input power of IM interferers at 4 and 8 MHz distance from wanted signal	9		-36		dBm
P_IM(5)	Input power of IM interferers at 5 and 10 MHz distance from wanted signal	9		-36		dBm

- a. Usable band is determined by local regulations.
- b. Data rate in each burst on-air.
- c. The minimum channel spacing is 1 MHz.
- d. Antenna load impedance = $15 \Omega + j88 \Omega$.
- e. Wanted signal level at Pin = 64 dBm. Two interferers with equal input power are used. The interferer closest in frequency is unmodulated, the other interferer is modulated equal to the wanted signal. The input power of interferers where the sensitivity equals BER=0.1% is presented.

Table 17. Transceiver characteristics

8.1 USB interface

The USB interface electrical performance is compliant with the USB specification 2.0.

Characteristic	Symbol	Conditions	Min.	Typ.	Max	Unit
Electrical characteristics						
Input high voltage (driven)	VIH		2.0			V
Input low voltage	VIL				0.8	V
Differential input sensitivity	VDI	$ (D+) - (D-) $	0.2			V
Differential common mode range	VCM	Includes VDI range	0.8		2.5	V
Single ended receiver threshold	VSE		0.8		2.0	V
Single ended receiver hysteresis	VSEH			200		mV
Output low voltage	VOL		0		0.3	V
Output high voltage	VOH		2.8		3.6	V
Differential output signal cross-point voltage	VCRS		1.3		2.0	V
Internal pull-up resistor (Standby mode)	R _{PU1}		900	1100	1575	Ω
Internal pull-up resistor (Active mode)	R _{PU2}		1425	2100	3090	Ω
Termination voltage connected to R _{PU}	VTRM		3.05		3.5	V
Output driver resistance (does not include the series resistance)	ZDRV	Steady state drive		15		Ω
Timing characteristics						
Driver rise time	TFR	CL=50pF	4		20	ns
Driver fall time	TFF	CL=50pF	4		20	ns
Rise/fall time matching	TFRFF	TRF / TFF	90		111	%
Transceiver pad capacitance	CIN	Pad to ground			20	pF

Table 18. USB interface characteristics

Symbol	Parameter (condition)	Notes	Min.	Typ.	Max.	Units
t_{Suspend}	Idle to suspend time				3.25	ms
t_{Reset}	Power on reset time, software reset, and reset pin				2.0	ms
$t_{\text{Response-Max}}$	The time the nRF24AP2-USB uses to respond to an input command				1.0	ms

Table 19. Serial timing

8.2 DC Electrical characteristics

Symbol	Parameter (condition)	Notes	Min.	Typ.	Max.	Units
	On-chip voltage regulators					
VDD	Output voltage	a	3.05	3.27	3.5	V
IVDD	External load current				2	mA

a. Also valid for VDD input voltage

Table 20. DC characteristics

Symbol	Parameter (condition)	Notes	Min.	Typ.	Max.	Units
V_{IH}	Input high voltage		$0.7 \cdot V_{\text{DD}}$		VDD	V
V_{IL}	Input low voltage		VSS		$0.3 \cdot V_{\text{DD}}$	V

Table 21. Digital inputs/outputs

8.3 Current consumption

The power nRF24AP2 consumes depends on the configuration of nRF24AP2.

Note: The nRF24AP2-USB is not intended for battery power application. Use the nRF24AP2-1CH or nRF24AP2-8CH for ultra low power applications.

[Table 22.](#) shows peak- and base current consumption for typical applications.

Conditions: TA = +25°C

Symbol	Parameter (condition)	Notes	Min.	Typ.	Max.	Units
I _{Idle}	No active channels—no communications			9.3		mA
I _{Suspend}	Suspend control activated			500		µA
I _{PeakRX}	Peak RX Current	a		22		mA
I _{PeakTX}	Peak TX Current at 0 dBm	b		20		mA
I _{PeakTX-6}	Peak TX Current at -6 dBm	b		18		mA
I _{PeakTX-12}	Peak TX Current at -12 dBm	b		17		mA
I _{PeakTX-18}	Peak TX Current at -18 dBm	b		16		mA

- a. Time of Maximum Current consumption in RX is typical 500 µs and maximum 1 ms.
- b. Time of maximum TX Only Current is typical 300 µs and maximum 350 µs.

Table 22. Peak- and base current consumption for nRF24AP2

9 Absolute maximum ratings

Maximum ratings are the extreme limits to which nRF24AP2 can be exposed without permanently damaging it. Exposure to absolute maximum ratings for prolonged periods of time may affect device reliability.

Note: For operating conditions see [Table 15. on page 32.](#)

Operating conditions	Minimum	Maximum	Units
Supply voltages			
V _{BUS}	-0.3	+5.75	V
V _{SS}		0	V
V _{DD}	-0.3	+3.6	V
Input voltage			
V _I	-0.3	+3.6	V
Temperatures			
Operating Temperature	-40	+85	°C
Storage Temperature ^a	-40	+85	°C

a. The device can withstand up to 125°C for short periods without damage. Recommended long-time storage temperature <65°C.

Table 23. Absolute maximum ratings

Note: Stress exceeding one or more of the limiting values may cause permanent damage to the device.

Attention!

<p>Observe precaution for handling Electrostatic Sensitive Device.</p> <p>HBM (Human Body Model): Class 1C</p>	
--	---

10 Mechanical specification

nRF24AP2-USB is packaged in the following QFN-package:

- QFN32 5 x 5 x 0.85 mm, 0.5 mm pitch.

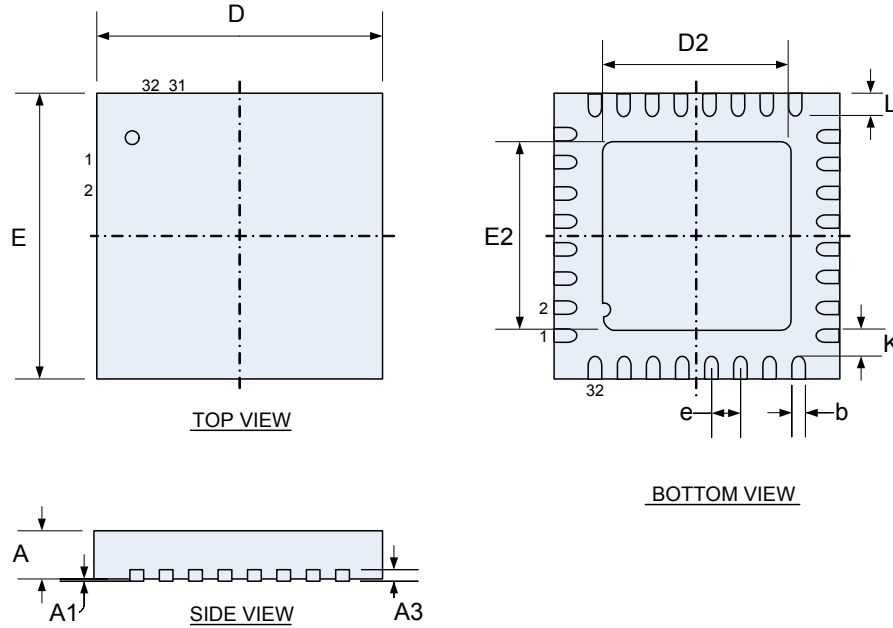

Figure 24. QFN32 pin 5x5mm

Package	A	A1	A3	b	D, E	D2, E2	e	K	L		
QFN32	0.80	0.00		0.18	4.9	3.20		0.20	0.35	Min	
	0.85	0.02	0.20	0.23	5.0	3.30	0.5			0.40	Typ
	0.90	0.05		0.30	5.1	3.40				0.45	Max

Table 24. QFN32 dimensions in mm

11 Reference circuitry

To ensure optimal performance it is essential that you follow the schematics- and layout references closely. Especially in the case of the antenna matching circuitry (components between device pins **ANT1**, **ANT2**, **VDD_PA** and the antenna), any changes in the layout can change the behavior, resulting in degradation of RF performance or a need to change component values. All the reference circuits are designed for use with a 50Ω single end antenna.

11.1 PCB guidelines

A well designed PCB is necessary to achieve good RF performance. A poor layout can lead to loss in performance or functionality. A fully qualified RF-layout for the nRF24AP2 and its surrounding components, including matching networks, can be downloaded from www.nordicsemi.com.

A PCB with a minimum of two layers including a ground plane is recommended for optimal performance. The nRF24AP2 DC supply voltage should be decoupled as close as possible to the VDD pins with high performance RF capacitors. See the schematics in [section 11.2 on page 40](#) for recommended decoupling capacitor values. The nRF24AP2 supply voltage should be filtered and routed separately from the supply voltages of any digital circuitry.

Long power supply lines on the PCB should be avoided. All device grounds, VDD connections and VDD bypass capacitors must be connected as close as possible to the nRF24AP2 IC. For a PCB with a topside RF ground plane, the **vss** pins should be connected directly to the ground plane. For a PCB with a bottom ground plane, the best technique is to have Via holes as close as possible to the VSS pads. A minimum of one Via hole should be used for each **vss** pin.

Full-swing digital data or control signals should not be routed close to the crystal or the power supply lines.

11.2 Schematics

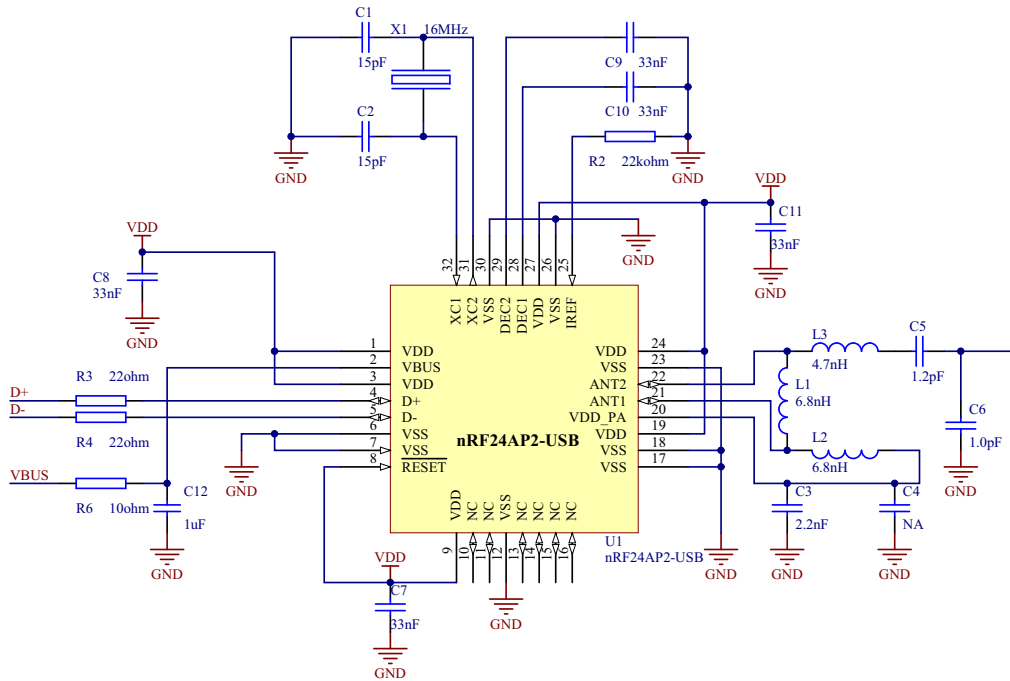
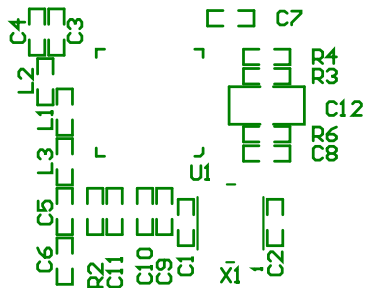

Figure 25. Schematic nRF24AP2-USB

11.3 Layout

A double sided FR-4 board of 1.6 mm thickness is used. This PCB has a ground plane on the bottom layer. There are ground areas on the component side of the board to ensure sufficient grounding of critical components. A large number of Via holes connect the top layer ground areas to the bottom layer ground plane.



Top silk screen

No components
in bottom layer

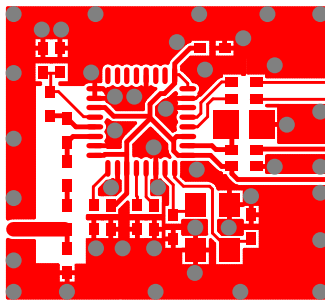

Top view

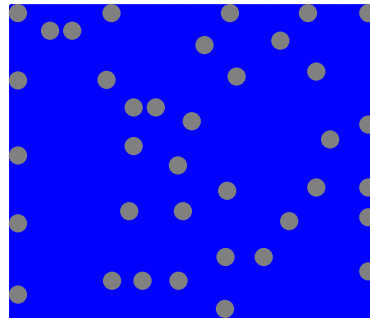

Bottom view



11.4 Bill Of Materials (BOM)

Designator	Value	Footprint	Comment
C1	15pF	0402	NP0 ±2%
C2	15pF	0402	NP0 ±2%
C3	2.2nF	0402	X7R ±10%
C4	Not mounted	0402	
C5	1.2pF	0402	NP0 ±0.1pF
C6	1.0pF	0402	NP0 ±0.1pF
C7	33nF	0402	X7R ±10%
C8	33nF	0402	X7R ±10%
C9	33nF	0402	X7R ±10%
C10	33nF	0402	X7R ±10%
C11	33nF	0402	X7R ±10%
C12	1uF	0805	X7R ±10%
L1	6.8nH	0402	High frequency chip inductor ±5%
L2	6.8nH	0402	High frequency chip inductor ±5%
L3	4.7nH	0402	High frequency chip inductor ±5%
R2	22kΩ	0402	±1%
R3	22Ω	0402	±1%
R4	22Ω	0402	±1%
R6	10Ω	0402	±5%
U1	nRF24AP2-USB	QFN32	nRF24AP2-USB
X1	16 MHz	3.2 x 2.5 mm	SMD-3225, 16 MHz, CL=9pF, ±50 ppm
PCB substrate	FR4 laminate	16.9 x 15.4 mm	2 layer, thickness 1.6 mm

Table 25. Bill Of Materials

12 Ordering information

12.1 Package marking

N	R	F		B	X
2	4	A	P	2	U
Y	Y	W	W	L	L

12.1.1 Abbreviations

Abbreviation	Definition
B	Build Code variable. Unique code for production sites, package type and test platform
X	"X" grade, that is, Engineering Samples (optional)
24AP2U	Product number
YY	Two-digit year number
WW	Two-digit week number
LL	Two-letter wafer-lot number code

Table 26. Abbreviations

12.2 Product options

12.2.1 RF silicon

Ordering code	Product	Package	Container	MOQ
nRF24AP2-USBQ32-T	nRF24AP2-USB Single chip ANT solution with USB	5x5mm 32-pin QFN	Tray	490
nRF24AP2-USBQ32-R7	nRF24AP2-USB Single chip ANT solution with USB	5x5mm 32-pin QFN	Tape-and-reel	1500
nRF24AP2-USBQ32-R	nRF24AP2-USB Single chip ANT solution with USB	5x5mm 32-pin QFN	Tape-and-reel	4000
nRF24AP2-USBQ32-S	nRF24AP2-USB Single chip ANT solution with USB	5x5mm 32-pin QFN	Sample box	5

Table 27. nRF24AP2 RF silicon options

12.2.2 Development tools

Type Number	Description
nRF6910	nRFready ANT USB dongle reference design

Table 28. nRF24AP2-USB reference design

13 Glossary

Term	Description
ANT™	Ultra-low power network protocol stack from Dynastream Innovations Inc.
ANT+	Alliance of companies making ANT based products. The ANT+ alliance develops and maintains device profiles for sports and wellness applications, enabling interoperability between products from the alliance members.
BER	Bit Error Rate
GFSK	Gaussian Frequency-Shift Keying
Independent channel	An ANT channel between two ANT devices that has a unique setup of RF frequency, timing and channel configuration
ISM	Industrial-Scientific-Medical
MCU	MicroController Unit
MOQ	Minimum Order Quantity
OSI	Open Systems Interconnection
PA	Power Amplifier
PCB	Printed Circuit Board
QFN	Quad Flat package. No leads
RFID	Radio Frequency Identification
Shared channel	ANT channel between two or more ANT devices that share RF frequency, timing and channel configuration
TDMA	Time Division Multiple Access
USB	Universal Serial Bus

Table 29. Glossary

Компания «Океан Электроники» предлагает заключение долгосрочных отношений при поставках импортных электронных компонентов на взаимовыгодных условиях!

Наши преимущества:

- Поставка оригинальных импортных электронных компонентов напрямую с производств Америки, Европы и Азии, а так же с крупнейших складов мира;
- Широкая линейка поставок активных и пассивных импортных электронных компонентов (более 30 млн. наименований);
- Поставка сложных, дефицитных, либо снятых с производства позиций;
- Оперативные сроки поставки под заказ (от 5 рабочих дней);
- Экспресс доставка в любую точку России;
- Помощь Конструкторского Отдела и консультации квалифицированных инженеров;
- Техническая поддержка проекта, помощь в подборе аналогов, поставка прототипов;
- Поставка электронных компонентов под контролем ВП;
- Система менеджмента качества сертифицирована по Международному стандарту ISO 9001;
- При необходимости вся продукция военного и аэрокосмического назначения проходит испытания и сертификацию в лаборатории (по согласованию с заказчиком);
- Поставка специализированных компонентов военного и аэрокосмического уровня качества (Xilinx, Altera, Analog Devices, Intersil, Interpoint, Microsemi, Actel, Aeroflex, Peregrine, VPT, Syfer, Eurofarad, Texas Instruments, MS Kennedy, Miteq, Cobham, E2V, MA-COM, Hittite, Mini-Circuits, General Dynamics и др.);

Компания «Океан Электроники» является официальным дистрибьютором и эксклюзивным представителем в России одного из крупнейших производителей разъемов военного и аэрокосмического назначения «JONHON», а так же официальным дистрибьютором и эксклюзивным представителем в России производителя высокотехнологичных и надежных решений для передачи СВЧ сигналов «FORSTAR».



JONHON

«JONHON» (основан в 1970 г.)

Разъемы специального, военного и аэрокосмического назначения:

(Применяются в военной, авиационной, аэрокосмической, морской, железнодорожной, горно- и нефтедобывающей отраслях промышленности)

«FORSTAR» (основан в 1998 г.)

ВЧ соединители, коаксиальные кабели,
кабельные сборки и микроволновые компоненты:

(Применяются в телекоммуникациях гражданского и специального назначения, в средствах связи, РЛС, а так же военной, авиационной и аэрокосмической отраслях промышленности).



Телефон: 8 (812) 309-75-97 (многоканальный)

Факс: 8 (812) 320-03-32

Электронная почта: ocean@oceanchips.ru

Web: <http://oceanchips.ru/>

Адрес: 198099, г. Санкт-Петербург, ул. Калинина, д. 2, корп. 4, лит. А