

FLARE-MAXI-D

34 x 33 mm lens with ~110° x 15° diffused oval beam

TECHNICAL SPECIFICATIONS:

Dimensions	33.9 x 33.3 mm
Height	16.5 mm
Fastening	glue, pin
ROHS compliant	yes ⓘ

MATERIAL SPECIFICATIONS:

Component	Type	Material	Colour	Finish
FLARE-MAXI-D	Single lens	PMMA	clear	



ORDERING INFORMATION:

Component	Qty in box	MOQ	MPQ	Box weight (kg)
C13012_FLARE-MAXI-D » Box size: 451 x 254 x 197 mm	840		168	9.7

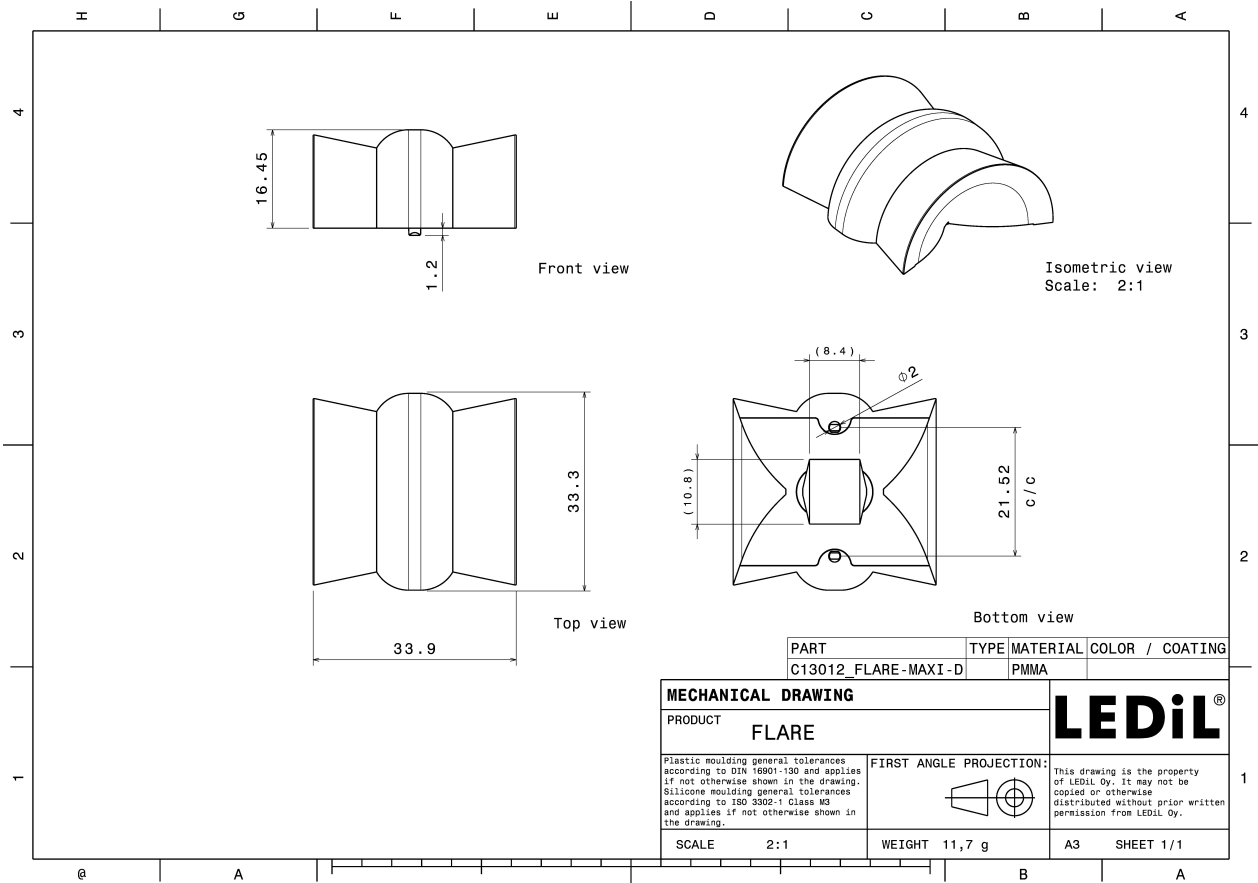

PHOTOMETRIC DATA (MEASURED):

CREE

LED MK-R
 FWHM 100.0 + 23.0°
 Efficiency 92 %
 Peak intensity 1.200 cd/lm
 LEDs/each optic 1
 Light colour White
 Required components:

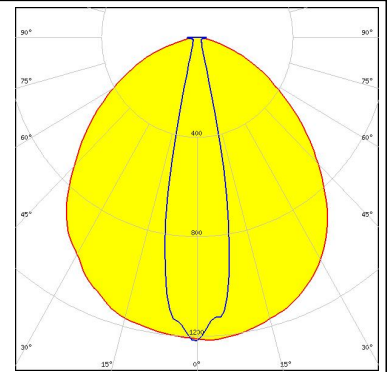

CREE

LED XHP50
 FWHM 104.0 + 19.0°
 Efficiency 92 %
 Peak intensity 1.300 cd/lm
 LEDs/each optic 1
 Light colour White
 Required components:

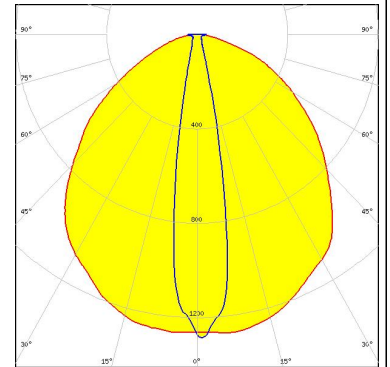
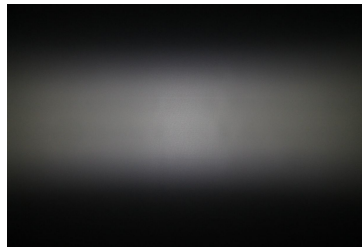

CREE

LED XHP70
 FWHM 104.0 + 28.0°
 Efficiency 92 %
 Peak intensity 0.940 cd/lm
 LEDs/each optic 1
 Light colour White
 Required components:

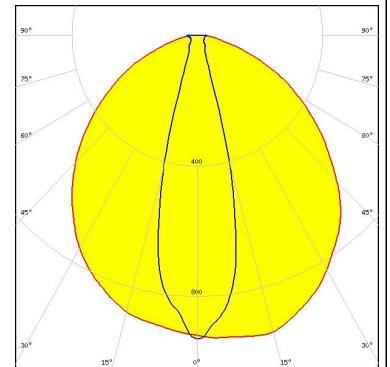
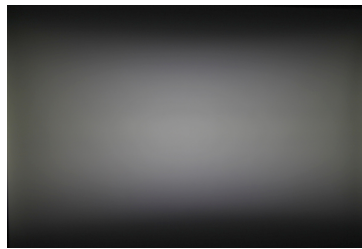

CREE

LED XM-L
 FWHM 110.0 + 15.0°
 Efficiency 94 %
 Peak intensity 1.700 cd/lm
 LEDs/each optic 1
 Light colour White
 Required components:

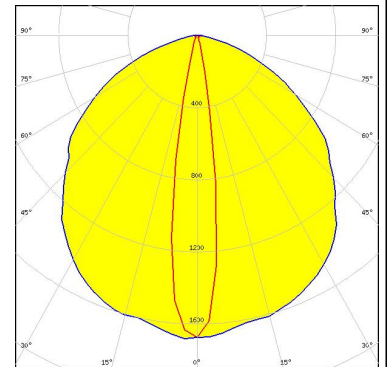

PHOTOMETRIC DATA (MEASURED):



LED XM-L2
 FWHM 101.0 + 17.0°
 Efficiency 94 %
 Peak intensity 1.900 cd/lm
 LEDs/each optic 1
 Light colour White
 Required components:

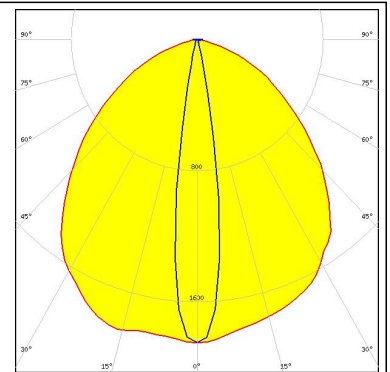
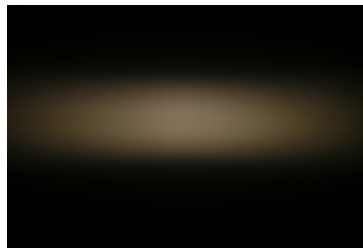

LED XP-G
 FWHM 115.0 + 15.0°
 Efficiency 94 %
 Peak intensity 1.900 cd/lm
 LEDs/each optic 1
 Light colour White
 Required components:

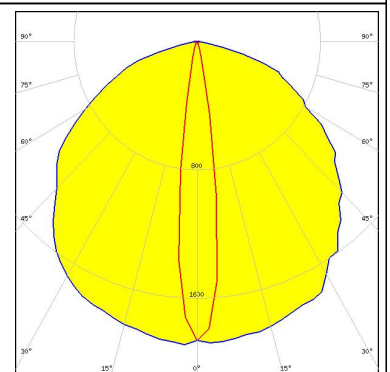

LED XP-G2
 FWHM 106.0 + 14.0°
 Efficiency 94 %
 Peak intensity 2.000 cd/lm
 LEDs/each optic 1
 Light colour White
 Required components:

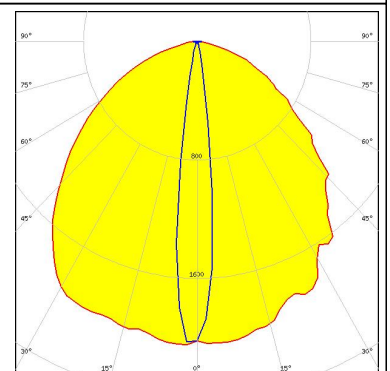

LED XP-L HD
 FWHM 119.0 + 16.0°
 Efficiency 94 %
 Peak intensity 1.480 cd/lm
 LEDs/each optic 1
 Light colour White
 Required components:

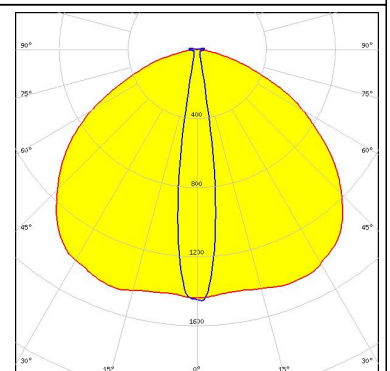
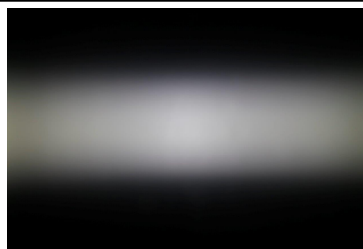

PHOTOMETRIC DATA (MEASURED):



LED XP-L2
 FWHM 107.0 + 16.0°
 Efficiency 94 %
 Peak intensity 1.500 cd/lm
 LEDs/each optic 1
 Light colour White
 Required components:

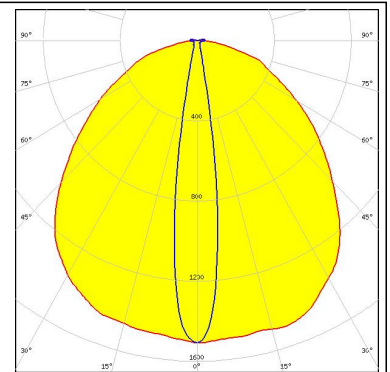
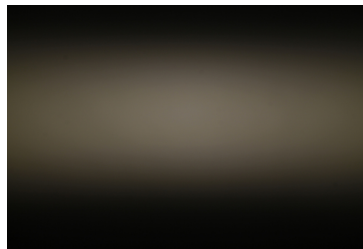

LED XT-E
 FWHM 117.0 + 14.0°
 Efficiency 94 %
 Peak intensity 1.900 cd/lm
 LEDs/each optic 1
 Light colour White
 Required components:

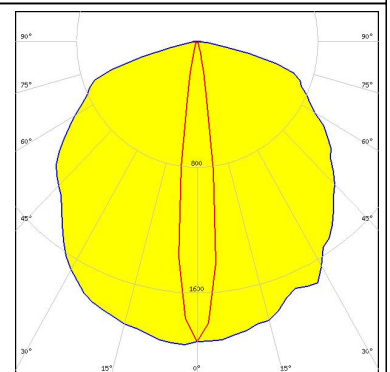

LED LUXEON A
 FWHM 104.0 + 12.0°
 Efficiency 94 %
 Peak intensity 2.100 cd/lm
 LEDs/each optic 1
 Light colour White
 Required components:

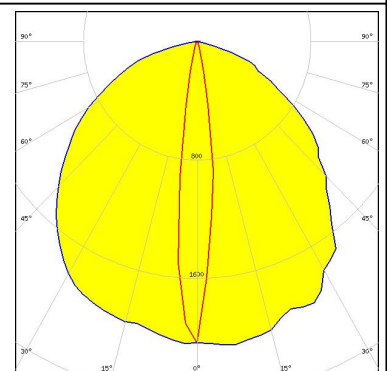

LED LUXEON M/MX
 FWHM 102.0 + 25.0°
 Efficiency 94 %
 Peak intensity 1.400 cd/lm
 LEDs/each optic 1
 Light colour White
 Required components:

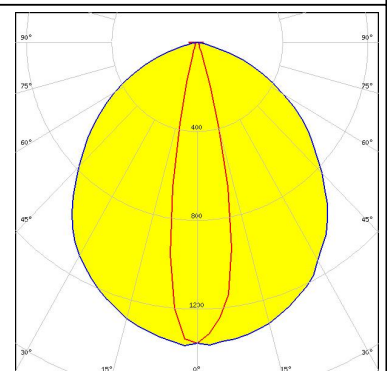
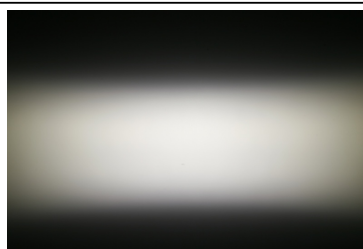

PHOTOMETRIC DATA (MEASURED):

LUMILEDS

LED LUXEON MZ
 FWHM 101.0 + 16.0°
 Efficiency 94 %
 Peak intensity 1.900 cd/lm
 LEDs/each optic 1
 Light colour White
 Required components:

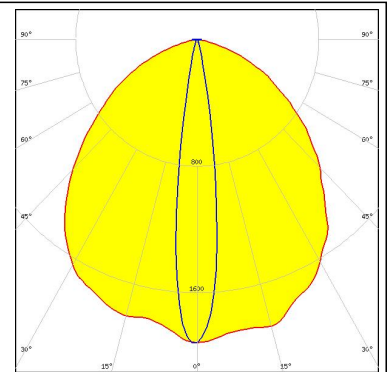

LUMILEDS

LED LUXEON Rebel ES
 FWHM 104.0 + 13.0°
 Efficiency 94 %
 Peak intensity 2.000 cd/lm
 LEDs/each optic 1
 Light colour White
 Required components:

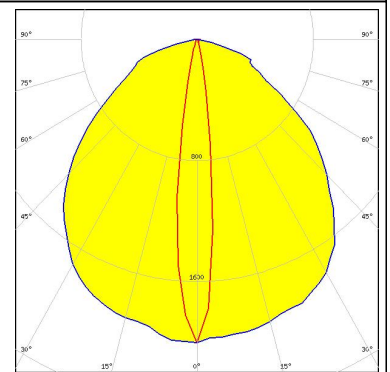

LUMILEDS

LED LUXEON T
 FWHM 102.0 + 13.0°
 Efficiency 92 %
 Peak intensity 1.800 cd/lm
 LEDs/each optic 1
 Light colour White
 Required components:

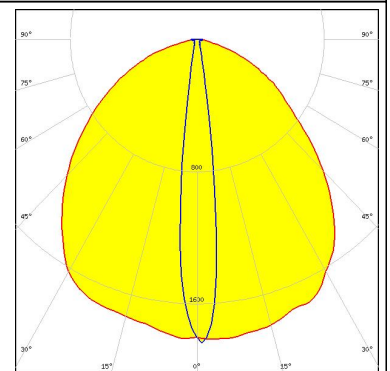

LUMILEDS

LED LUXEON TX
 FWHM 103.0 + 13.0°
 Efficiency 93 %
 Peak intensity 2.060 cd/lm
 LEDs/each optic 1
 Light colour White
 Required components:

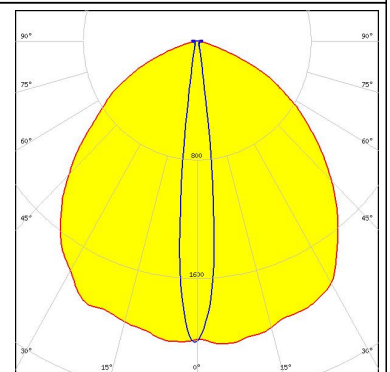
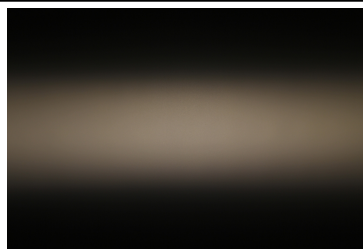

PHOTOMETRIC DATA (MEASURED):



LED NCSxx19B
 FWHM 107.0 + 13.0°
 Efficiency 94 %
 Peak intensity 2.100 cd/lm
 LEDs/each optic 1
 Light colour White
 Required components:

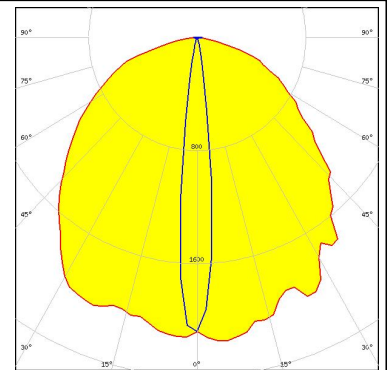

LED NS9x383
 FWHM 110.0 + 16.0°
 Efficiency 93 %
 Peak intensity 1.500 cd/lm
 LEDs/each optic 1
 Light colour White
 Required components:

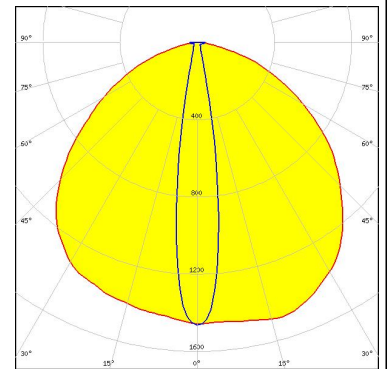

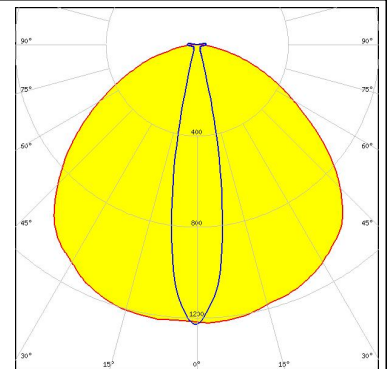

LED NV4x144A
 FWHM 111.0 + 20.0°
 Efficiency 89 %
 Peak intensity 0.600 cd/lm
 LEDs/each optic 1
 Light colour White
 Required components:

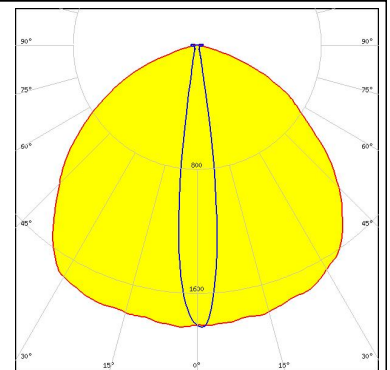
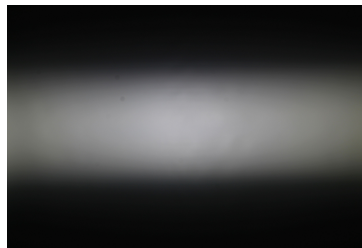

LED NVSW219F
 FWHM 109.0 + 14.0°
 Efficiency 94 %
 Peak intensity 1.900 cd/lm
 LEDs/each optic 1
 Light colour White
 Required components:

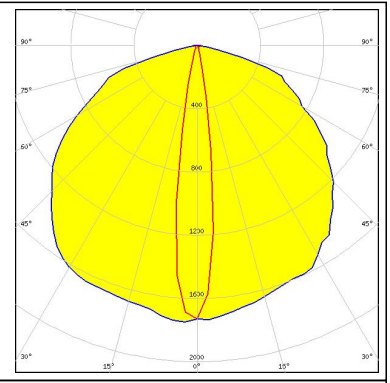
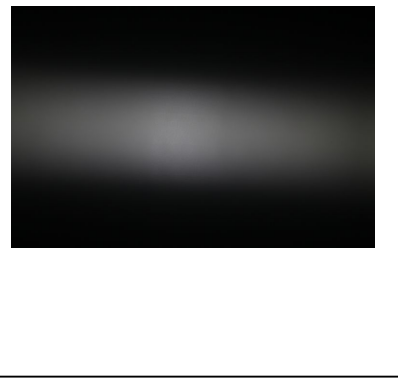
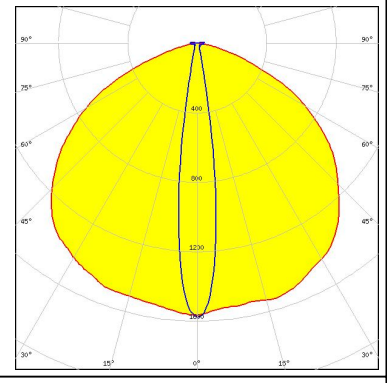

PHOTOMETRIC DATA (MEASURED):

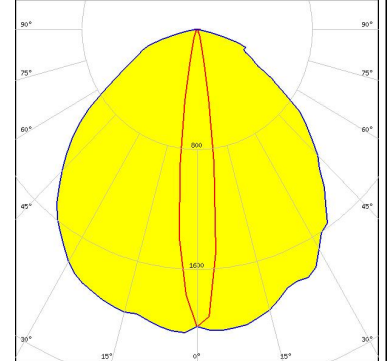
<p>NICHIA</p> <p>LED NVSxx19B/NVSxx19C FWHM 116.0 + 13.0° Efficiency 94 % Peak intensity 1.700 cd/lm LEDs/each optic 1 Light colour White Required components:</p>		
<p>NICHIA</p> <p>LED NWSx229A FWHM 117.0 + 15.0° Efficiency 92 % Peak intensity 1.600 cd/lm LEDs/each optic 1 Light colour White Required components:</p>		
<p>OSRAM <small>Opto Semiconductors</small></p> <p>LED Duris S10 FWHM 92.0 + 20.0° Efficiency 93 % Peak intensity 1.600 cd/lm LEDs/each optic 1 Light colour White Required components:</p>		
<p>OSRAM <small>Opto Semiconductors</small></p> <p>LED OSLON Square EC FWHM 99.0 + 14.0° Efficiency 94 % Peak intensity 2.000 cd/lm LEDs/each optic 1 Light colour White Required components:</p>		

PHOTOMETRIC DATA (MEASURED):

OSRAM

Opto Semiconductors

LED OSLON Square PC
 FWHM 104.0 + 12.0°
 Efficiency 94 %
 Peak intensity 2.000 cd/lm
 LEDs/each optic 1
 Light colour White
 Required components:

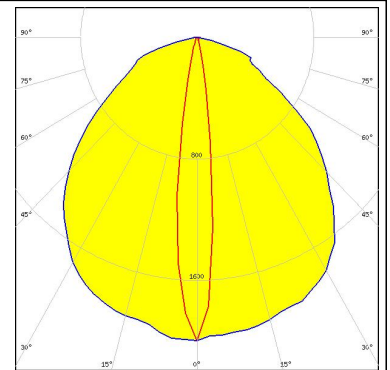

OSRAM

Opto Semiconductors

LED OSLON SSL 150
 FWHM 128.0 + 13.0°
 Efficiency 94 %
 Peak intensity 2.000 cd/lm
 LEDs/each optic 1
 Light colour White
 Required components:

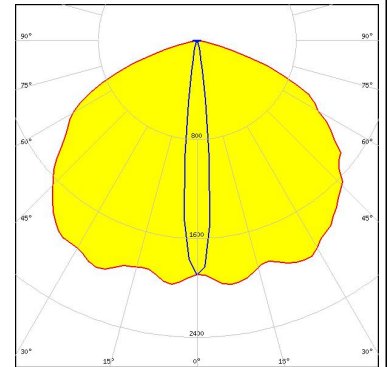
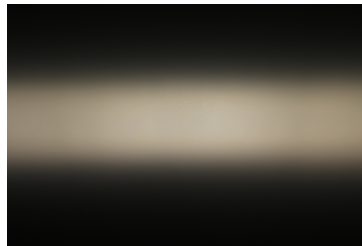

SAMSUNG

LED LH351Z
 FWHM 98.0 + 13.0°
 Efficiency 94 %
 Peak intensity 2.200 cd/lm
 LEDs/each optic 1
 Light colour White
 Required components:

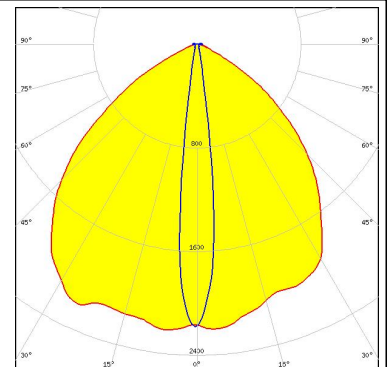
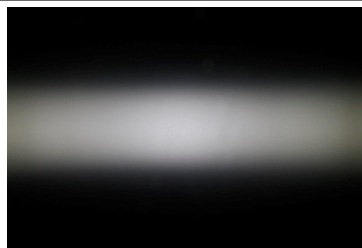

SEOUL SEMICONDUCTOR

LED Z5M1/Z5M2
 FWHM 104.0 + 14.0°
 Efficiency 94 %
 Peak intensity 2.100 cd/lm
 LEDs/each optic 1
 Light colour White
 Required components:

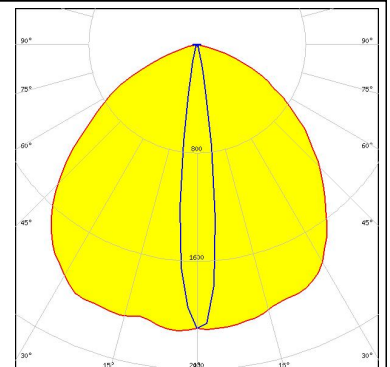
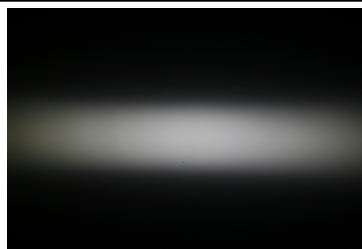

PHOTOMETRIC DATA (MEASURED):

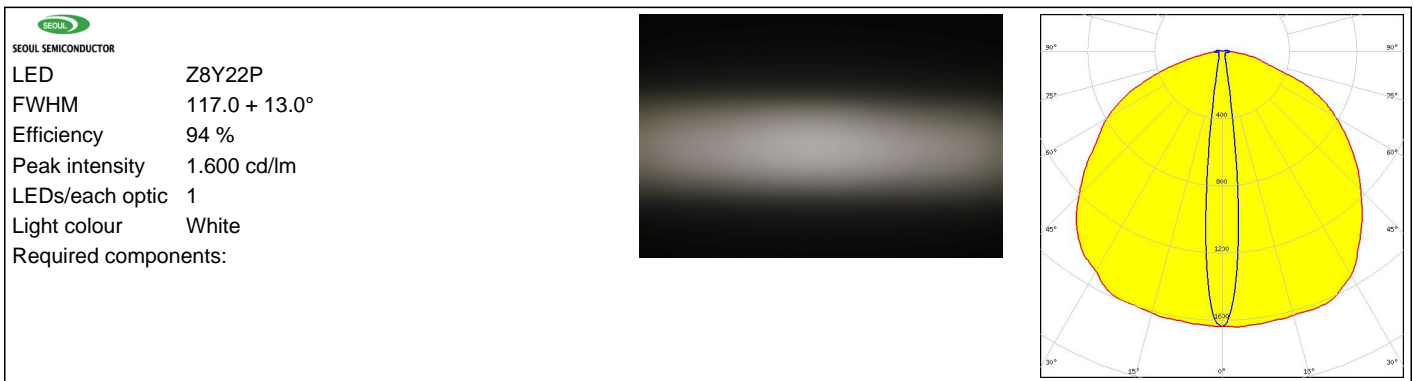

PHOTOMETRIC DATA (SIMULATED):



LED XHP50.2
 FWHM 92.0 + 20.0°
 Efficiency 94 %
 Peak intensity 1.530 cd/lm
 LEDs/each optic 1
 Light colour White
 Required components:

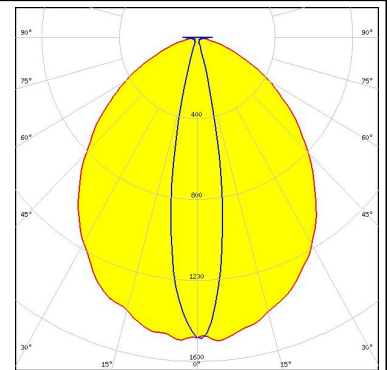

LED XP-G2 HE
 FWHM 84.0 + 13.0°
 Efficiency 95 %
 Peak intensity 2.311 cd/lm
 LEDs/each optic 1
 Light colour White
 Required components:

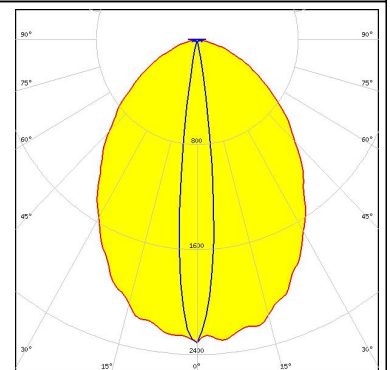

LED LUXEON H50-2
 FWHM 10.0 + 65.0°
 Efficiency 92 %
 Peak intensity 3.300 cd/lm
 LEDs/each optic 1
 Light colour White
 Required components:

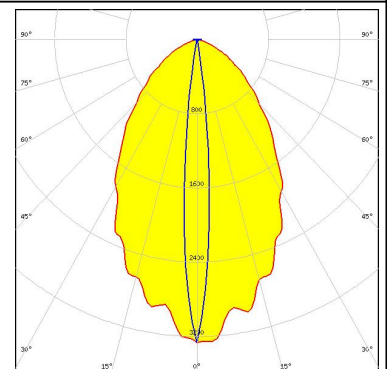

LED OSCONIQ P 7070
 FWHM 86.0 + 18.0°
 Efficiency 92 %
 Peak intensity 1.740 cd/lm
 LEDs/each optic 1
 Light colour White
 Required components:

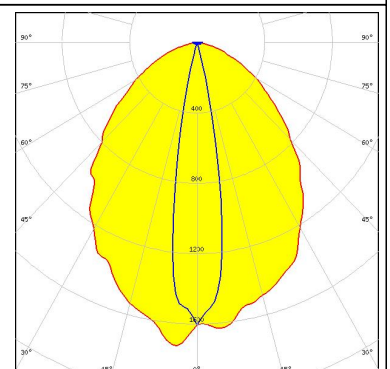
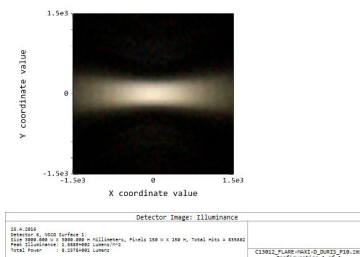

GENERAL INFORMATION:

NOTE: The typical beam angle will be changed by different color, chip size and chip position tolerance. The typical total beam angle is the full angle measured where the luminous intensity is half of the peak value.

MATERIALS:

As part of our continuous research and improvement processes, and to ensure the best possible quality and availability of our products, LEDiL reserves the right to change material grades without notice.

PRODUCT DATA USER AGREEMENT AND DISCLAIMER:

The measured data in the provided downloadable LEDiL Product Datasheets and Mechanical 2D-Drawings is rounded and provided as reference for planning. LEDiL Oy's optical specifications have been verified by conducting performance testing of the products in accordance with the company's quality system. The reported data are averaged results of multiple measurements with typical variation. LEDiL Oy reserves the right to without prior notification make changes and improvements to its products.

LEDiL Oy assumes neither warranty, nor guarantee nor any other liability of any kind for the contents and correctness of the provided data. The provided data has been generated with highest diligence but the provided data may in reality not represent the complete possible variation range of all intrinsic parameters. Therefore, in certain cases a deviation from the provided data could occur.

LEDiL Oy reserves the right to undertake technical changes of its products without further notification which could lead to changes in the provided data. LEDiL Oy assumes no liability of any kind for the possible deviation from any provided data or any other damage resulting from the usage of the provided data.

The user agrees to this disclaimer and user agreement with the download or usage of the provided files.

LEDiL Oy

Joensuunkatu 13
FI-24240 SALO
Finland

LEDiL Inc.

228 West Page Street
Suite D
Sycamore IL 60178
USA

Local sales and technical support

[www.ledil.com/
where_to_buy](http://www.ledil.com/where_to_buy)

Shipping locations

Salo, Finland
Hong Kong, China

Distribution Partners

[www.ledil.com/
where_to_buy](http://www.ledil.com/where_to_buy)

Компания «Океан Электроники» предлагает заключение долгосрочных отношений при поставках импортных электронных компонентов на взаимовыгодных условиях!

Наши преимущества:

- Поставка оригинальных импортных электронных компонентов напрямую с производств Америки, Европы и Азии, а так же с крупнейших складов мира;
- Широкая линейка поставок активных и пассивных импортных электронных компонентов (более 30 млн. наименований);
- Поставка сложных, дефицитных, либо снятых с производства позиций;
- Оперативные сроки поставки под заказ (от 5 рабочих дней);
- Экспресс доставка в любую точку России;
- Помощь Конструкторского Отдела и консультации квалифицированных инженеров;
- Техническая поддержка проекта, помощь в подборе аналогов, поставка прототипов;
- Поставка электронных компонентов под контролем ВП;
- Система менеджмента качества сертифицирована по Международному стандарту ISO 9001;
- При необходимости вся продукция военного и аэрокосмического назначения проходит испытания и сертификацию в лаборатории (по согласованию с заказчиком);
- Поставка специализированных компонентов военного и аэрокосмического уровня качества (Xilinx, Altera, Analog Devices, Intersil, Interpoint, Microsemi, Actel, Aeroflex, Peregrine, VPT, Syfer, Eurofarad, Texas Instruments, MS Kennedy, Miteq, Cobham, E2V, MA-COM, Hittite, Mini-Circuits, General Dynamics и др.);

Компания «Океан Электроники» является официальным дистрибьютором и эксклюзивным представителем в России одного из крупнейших производителей разъемов военного и аэрокосмического назначения «JONHON», а так же официальным дистрибьютором и эксклюзивным представителем в России производителя высокотехнологичных и надежных решений для передачи СВЧ сигналов «FORSTAR».



JONHON

«JONHON» (основан в 1970 г.)

Разъемы специального, военного и аэрокосмического назначения:

(Применяются в военной, авиационной, аэрокосмической, морской, железнодорожной, горно- и нефтедобывающей отраслях промышленности)

«FORSTAR» (основан в 1998 г.)

ВЧ соединители, коаксиальные кабели, кабельные сборки и микроволновые компоненты:

(Применяются в телекоммуникациях гражданского и специального назначения, в средствах связи, РЛС, а так же военной, авиационной и аэрокосмической отраслях промышленности).



Телефон: 8 (812) 309-75-97 (многоканальный)

Факс: 8 (812) 320-03-32

Электронная почта: ocean@oceanchips.ru

Web: <http://oceanchips.ru/>

Адрес: 198099, г. Санкт-Петербург, ул. Калинина, д. 2, корп. 4, лит. А