

NTC Thermistors



⚠Note • Please read rating and ⚠CAUTION (for storage, operating, rating, soldering, mounting and handling) in this catalog to prevent smoking and/or burning, etc.
• This catalog has only typical specifications. Therefore, please approve our product specifications or transact the approval sheet for product specifications before ordering.

EU RoHS Compliant

- All the products in this catalog comply with EU RoHS.
- EU RoHS is "the European Directive 2011/65/EU on the Restriction of the Use of Certain Hazardous Substances in Electrical and Electronic Equipment."
- For more details, please refer to our website 'Murata's Approach for EU RoHS' (<http://www.murata.com/info/rohs.html>).

Contents

Product specifications are as of December 2014.

Part Numbering	p2
Basic Characteristics	p6
<hr/>	
1 Temperature Sensor and Compensation 0201 (0603) Size	p7
<hr/>	
2 Temperature Sensor and Compensation 0402 (1005) Size	p8
<hr/>	
3 Temperature Sensor and Compensation 0603 (1608) Size	p10
<hr/>	
4 Temperature Sensor and Compensation 0805 (2012) Size	p12
<hr/>	
Temperature Sensor and Compensation Chip Type Standard Land Pattern Dimensions	p13
Temperature Sensor and Compensation Chip Type Temperature Characteristics (Center Value)	p14
Temperature Sensor and Compensation Chip Type ⚠Caution/Notice	p18
Temperature Sensor and Compensation Chip Type Package	p22
<hr/>	
5 Temperature Sensor Thermo String Type	p25
Temperature Sensor Thermo String Type Specifications and Test Methods	p26
<hr/>	
6 Temperature Sensor Lead Type	p28
Temperature Sensor Lead Type Specifications and Test Methods	p29
<hr/>	
7 Temperature Sensor Lead Insulation Type (Radial Type)	p30
Temperature Sensor Lead Insulation Type (Radial Type) Specifications and Test Methods ..	p31
<hr/>	
Temperature Sensor Thermo String/Lead Type Temperature Characteristics (Center Value)	p32
Temperature Sensor Thermo String/Lead Type ⚠Caution/Notice	p33
Temperature Sensor Thermo String/Lead Type Package	p35
<hr/>	
8 Inrush Current Suppression Lead Type	p36
Current - R Ratio (RT/R25)/ Current - Temperature Characteristics (Typical) ..	p38
Inrush Current Suppression Lead Type ⚠Caution/Notice	p42
Inrush Current Suppression Lead Type Package	p44

Please check the MURATA home page (<http://www.murata.com/>) if you cannot find the part number in the catalog.

1

2

3

4

5

6

7

8

● Part Numbering

NTC Thermistors for Temp. Sensor and Compensation Chip Type

(Part Number)

NC	P	18	XH	103	J	03	RB
①	②	③	④	⑤	⑥	⑦	⑧

① Product ID

Product ID	
NC	NTC Thermistors Chip Type

② Series

Code	Series
P	Plated Termination Series

③ Dimensions (L×W)

Code	Dimensions (L×W)	EIA
03	0.60×0.30mm	0201
15	1.00×0.50mm	0402
18	1.60×0.80mm	0603
21	2.00×1.25mm	0805

④ Temperature Characteristics

Code	Temperature Characteristics
XC	Nominal B-Constant 3100—3149K
XF	Nominal B-Constant 3250—3299K
XH	Nominal B-Constant 3350—3399K
XM	Nominal B-Constant 3500—3549K
XQ	Nominal B-Constant 3650—3699K
XV	Nominal B-Constant 3900—3949K
XW	Nominal B-Constant 3950—3999K
WB	Nominal B-Constant 4050—4099K
WD	Nominal B-Constant 4150—4199K
WF	Nominal B-Constant 4250—4299K
WL	Nominal B-Constant 4450—4499K
WM	Nominal B-Constant 4500—4549K

⑤ Resistance

Expressed by three-digit alphanumerics. The unit is ohm (Ω). The first and second figures are significant digits, and the third figure expresses the number of zeros that follow the two figures.

Ex.

Code	Resistance
102	1k Ω
103	10k Ω
104	100k Ω

⑥ Resistance Tolerance

Code	Resistance Tolerance
D	$\pm 0.5\%$
F	$\pm 1\%$
E	$\pm 3\%$
J	$\pm 5\%$

⑦ Individual Specifications

Structures and other specifications are expressed by two figures.

Ex.

Code	Individual Specifications
03	Standard Type

⑧ Packaging

Code	Packaging
RA	Plastic Taping 4mm Pitch (4000 pcs.)
RB	Paper Taping 4mm Pitch (4000 pcs.)
RC	Paper Taping 2mm Pitch (10000 pcs.)
RL	Paper Taping 2mm Pitch (15000 pcs.)

NTC Thermistor for Temperature Sensor Thermo String Type

(Part Number)

NXF	T	15	XH	103	F	A	2	B	025
①	②	③	④	⑤	⑥	⑦	⑧	⑨	⑩

① Product ID

Product ID	
NXF	NTC Thermistors Sensor Thermo String Type

② Individual Specifications

Code	Individual Specifications
T	Commercial Type

③ Chip Dimensions

Code	Dimensions (LxT)	EIA
15	1.00 x 0.50mm	0402

④ Temperature Characteristics

Code	Temperature Characteristics
XH	Nominal B-Constant 3350–3399K
XV	Nominal B-Constant 3900–3949K
WB	Nominal B-Constant 4050–4099K
WF	Nominal B-Constant 4250–4299K

⑤ Resistance

Expressed by three figures. The unit is (Ω). The first and second figures are significant digits, and the third figure expresses the number of zeros that follow the two figures.

Ex.

Code	Resistance
103	10kΩ
104	100kΩ

⑥ Resistance Tolerance

Code	Resistance Tolerance
F	±1%

⑦ Lead Wire Type

Code	Lead Wire Type
A	ø0.3mm Copper Lead Wire with Polyurethane Coat

⑧ Shape of the Lead Wire Kink

Code	Shape of the Lead Wire Kink
1	Twisted Lead Wire Type
2	Standard Type

⑨ Packaging

Code	Packaging
B	Bulk

⑩ Dimensions (Full Length)

Code	Dimensions (Full Length)
025	25mm
030	30mm
040	40mm
050	50mm
060	60mm
070	70mm
080	80mm
090	90mm
100	100mm
110	110mm
120	120mm
130	130mm
140	140mm
150	150mm

NTC Thermistor for Temperature Sensor/Lead Type

(Part Number)

NXR	T	15	XH	103	F	A	1	B	040
①	②	③	④	⑤	⑥	⑦	⑧	⑨	⑩

① Product ID

Product ID	
NXR	NTC Thermistor Sensor/Lead Type

② Individual Specifications

Code	Individual Specifications
T	Commercial Type

③ Chip Dimensions

Code	Dimensions (LxT)
15	1.00 x 0.50mm

④ Temperature Characteristics

Code	Temperature Characteristics
XH	Nominal B-Constant 3350–3399K
XM	Nominal B-Constant 3500–3549K
XV	Nominal B-Constant 3900–3949K
WB	Nominal B-Constant 4050–4099K
WF	Nominal B-Constant 4250–4299K

⑤ Resistance

Expressed by three figures. The unit is (Ω). The first and second figures are significant digits, and the third figure expresses the number of zeros that follow the two figures.

Ex.

Code	Resistance
202	2.0kΩ
103	10kΩ
104	100kΩ

⑥ Resistance Tolerance

Code	Resistance Tolerance
F	±1%
E	±3%
J	±5%

⑦ Lead Wire Type

Code	Lead Wire Type
A	Lead Type: ø0.4mm Copper-clad Fe Wire, Tinned Lead Insulation Type: ø0.46mm Cu Wire with Coat

⑧ Shape of the Lead Wire

Code	Shape of the Lead Wire
1	Lead Spacing 2.5mm
3	Lead Spacing 5.0mm
5	Lead Spacing 2.5mm (Insulation Type)

⑨ Packaging

Code	Packaging
A	Ammo Pack Taping
B	Bulk

⑩ Dimensions (Full Length)

Code	Dimensions (Full Length)
010	10mm
020	20mm
025	25mm (Insulation Type only)
030	30mm
035	35mm (Insulation Type only)
040	40mm
045	45mm (Insulation Type only)
016	16mm (Taping Type/Lead distance between reference and bottom planes)

NTC Thermistors for Inrush Current Suppression Lead Type

(Part Number)

NT	PA7	160	L	BM	B0
①	②	③	④	⑤	⑥

① Product ID

Product ID	
NT	NTC Thermistors

② Series

Code	Series	Nominal Body Diameter
PA5	Inrush Current Suppression Lead Type	ø5mm
PA6		ø6mm
PA7		ø7mm
PA9		ø9mm
PAA		ø10mm
PAD		ø13mm
PAJ		ø18mm
PAN		ø22mm

③ Resistance

Expressed by three-digit alphanumerics. The unit is ohm (Ω). The first and second figures are significant digits, and the third figure expresses the number of zeros that follow the two figures. If there is a decimal point, it is expressed by the capital letter "R." In this case, all figures are significant digits.

Ex.

Code	Resistance
3R0	3 Ω
100	10 Ω

④ Resistance Tolerance

Code	Resistance Tolerance
L	±15%

⑤ Individual Specifications

The lead structure and other specifications are expressed by two-digit alphanumerics.

Code	Individual Specifications	Body Diameter
B1	Standard Type (Ammo Pack)	ø7mm, ø9mm
BM	Standard Type (Bulk)	ø7mm, ø9mm
D6	Standard Type (Ammo Pack)	ø10mm, ø13mm
DK	Standard (Bulk)	ø18mm, ø22mm
DN	Standard (Bulk)	ø10mm, ø13mm

⑥ Packaging

Code	Packaging
A0	Ammo Pack Taping
B0	Bulk

Basic Characteristics

Basic Characteristics

1. Zero-power Resistance of Thermistor: R

$$R = R_0 \exp B (1/T - 1/T_0) \dots\dots\dots(1)$$

R: Resistance in ambient temperature T (K)
 (K: absolute temperature)

R₀: Resistance in ambient temperature T₀ (K)

B: B-Constant of Thermistor

2. B-Constant

as (1) formula

$$B = \ell n (R/R_0) / (1/T - 1/T_0) \dots\dots\dots(2)$$

3. Thermal Dissipation Constant

When electric power P (mW) is spent in ambient temperature T₁ and thermistor temperature rises T₂, the formula is as follows

$$P = C (T_2 - T_1) \dots\dots\dots(3)$$

C: Thermal dissipation constant (mW/°C)

Thermal dissipation constant is varied with dimensions, measurement conditions, etc.



4. Thermal Time Constant

Period in which the thermistor's temperature will change 63.2% of its temperature difference from ambient temperature T₀ (°C) to T₁ (°C).



Performance

Item	Condition
Resistance	Measured by zero-power in specified ambient temperature.
B-Constant	Calculated between two specified ambient temperatures by the next formula. T and T ₀ is absolute temperature (K). $B = \frac{\ell n (R/R_0)}{1/T - 1/T_0}$
Thermal Dissipation Constant	Shows necessary electric power that Thermistor's temperature rises 1°C by self-heating. It is calculated by the next formula (mW/°C). $C = \frac{P}{T - T_0}$
Rated Electric Power	Shows the required electric power that causes the thermistor's temperature to rise to a specified temperature by self-heating, at ambient temperature of 25 °C.
Permissible Operating Current	It is possible to keep the thermistor's temperature rising max. 1°C.

Please inquire about test conditions and ratings.

NTC Thermistors

Temperature Sensor and Compensation 0201 (0603) Size

Chip NTC Thermistors' Ni barrier termination provides excellent solderability and their unique construction offers high stability in the application's environment.

■ Features

1. Excellent solderability and high stability in the application's environment
2. Excellent long-term stability
3. High accuracy in resistance and B-Constant
4. Reflow soldering possible
5. NCP series are recognized by UL/cUL.
(UL1434, File No.E137188)



■ Applications

1. Temperature compensation for transistors, ICs, and crystal oscillators in mobile communications
2. Temperature sensor for rechargeable batteries

Part Number	Resistance (25°C) (ohm)	B-Constant (25-50°C) (K)	B-Constant (25-80°C) (Reference Value) (K)	B-Constant (25-85°C) (Reference Value) (K)	B-Constant (25-100°C) (Reference Value) (K)	Permissible Operating Current (25°C) (mA)	Rated Electric Power (25°C) (mW)	Typical Dissipation Constant (25°C) (mW/°C)
NCP03XM102□05RL	1.0k	3500 ±1%	3539	3545	3560	1.00	100	1
NCP03XM152□05RL	1.5k	3500 ±1%	3539	3545	3560	0.81	100	1
NCP03XM222□05RL	2.2k	3500 ±1%	3539	3545	3560	0.67	100	1
NCP03XM332□05RL	3.3k	3500 ±1%	3539	3545	3560	0.55	100	1
NCP03XM472□05RL	4.7k	3500 ±1%	3539	3545	3560	0.46	100	1
NCP03XH682□05RL	6.8k	3380 ±1%	3428	3434	3455	0.38	100	1
NCP03XH103F05RL	10k ±1%	3380 ±1%	3428	3434	3455	0.31	100	1
NCP03XH103□05RL	10k	3380 ±1%	3428	3434	3455	0.31	100	1
NCP03XV103□05RL	10k	3900 ±1%	3930	3934	3944	0.31	100	1
NCP03XH153□05RL	15k	3380 ±1%	3428	3434	3455	0.25	100	1
NCP03XH223□05RL	22k	3380 ±1%	3428	3434	3455	0.21	100	1
NCP03WF333□05RL	33k	4250 ±1%	4303	4311	4334	0.17	100	1
NCP03WB473□05RL	47k	4050 ±3%	4101	4108	4131	0.14	100	1
NCP03WL473□05RL	47k	4485 ±1%	4537	4543	4557	0.14	100	1
NCP03WF683□05RL	68k	4250 ±1%	4303	4311	4334	0.12	100	1
NCP03WL683□05RL	68k	4485 ±1%	4537	4543	4557	0.12	100	1
NCP03WF104F05RL	100k ±1%	4250 ±1%	4303	4311	4334	0.10	100	1
NCP03WF104□05RL	100k	4250 ±1%	4303	4311	4334	0.10	100	1
NCP03WL104□05RL	100k	4485 ±1%	4537	4543	4557	0.10	100	1
NCP03WL154□05RL	150k	4485 ±1%	4537	4543	4557	0.08	100	1
NCP03WL224□05RL	220k	4485 ±1%	4537	4543	4557	0.06	100	1

□ is filled with resistance tolerance codes (E: ±3%, J: ±5%).

Rated Electric Power shows the required electric power that the thermistor's temperature rise to 125°C by self-heating, at ambient temperature of 25 °C.

Operating Temperature Range: -40°C to +125°C

NTC Thermistors

Temperature Sensor and Compensation 0402 (1005) Size

2

Chip NTC Thermistors' Ni barrier termination provides excellent solderability and their unique construction offers high stability in the application's environment.

■ Features

1. Excellent solderability and high stability in the application's environment
2. Excellent long-term stability
3. High accuracy in resistance and B-Constant
4. Reflow soldering possible
5. Same B-constant in the same resistance in the three sizes (0805 size / 0603 size / 0402 size)
Downsize is easy for design.
6. NCP series are recognized by UL/cUL.
(UL1434, File No.E137188)

■ Applications

1. Temperature compensation for transistors, ICs, and crystal oscillators in mobile communications
2. Temperature sensor for rechargeable batteries
3. Temperature compensation of LCD
4. Temperature compensation in general use of electric circuits



Part Number	Resistance (25°C) (ohm)	B-Constant (25-50°C) (K)	B-Constant (25-80°C) (Reference Value) (K)	B-Constant (25-85°C) (Reference Value) (K)	B-Constant (25-100°C) (Reference Value) (K)	Permissible Operating Current (25°C) (mA)	Rated Electric Power (25°C) (mW)	Typical Dissipation Constant (25°C) (mW/°C)
NCP15XC220□03RC	22	3100 ±3%	3126	3128	3136	6.70	100	1
NCP15XC330□03RC	33	3100 ±3%	3126	3128	3136	5.50	100	1
NCP15XC470□03RC	47	3100 ±3%	3126	3128	3136	4.60	100	1
NCP15XC680□03RC	68	3100 ±3%	3126	3128	3136	3.80	100	1
NCP15XF101□03RC	100	3250 ±3%	3282	3284	3296	3.10	100	1
NCP15XF151□03RC	150	3250 ±3%	3282	3284	3296	2.50	100	1
NCP15XM221□03RC	220	3500 ±3%	3539	3545	3560	2.10	100	1
NCP15XM331□03RC	330	3500 ±3%	3539	3545	3560	1.70	100	1
NCP15XQ471□03RC	470	3650 ±2%	3688	3693	3706	1.40	100	1
NCP15XQ681□03RC	680	3650 ±3%	3688	3693	3706	1.20	100	1
NCP15XQ102□03RC	1.0k	3650 ±2%	3688	3693	3706	1.00	100	1
NCP15XW152□03RC	1.5k	3950 ±3%	3982	3987	3998	0.81	100	1
NCP15XW222□03RC	2.2k	3950 ±3%	3982	3987	3998	0.67	100	1
NCP15XW332□03RC	3.3k	3950 ±3%	3982	3987	3998	0.55	100	1
NCP15XM472□03RC	4.7k	3500 ±2%	3539	3545	3560	0.46	100	1
NCP15XW472□03RC	4.7k	3950 ±3%	3982	3987	3998	0.46	100	1
NCP15XW682□03RC	6.8k	3950 ±3%	3982	3987	3998	0.38	100	1
NCP15XH103D03RC	10k ±0.5%	3380 ±0.7%	3428	3434	3455	0.31	100	1
NCP15XH103F03RC	10k ±1%	3380 ±1%	3428	3434	3455	0.31	100	1
NCP15XH103□03RC	10k	3380 ±1%	3428	3434	3455	0.31	100	1
NCP15XV103□03RC	10k	3900 ±3%	3930	3934	3944	0.31	100	1
NCP15XW153□03RC	15k	3950 ±3%	3982	3987	3998	0.25	100	1
NCP15XW223□03RC	22k	3950 ±3%	3982	3987	3998	0.21	100	1
NCP15WL223□03RC	22k	4485 ±1%	4537	4543	4557	0.21	100	1
NCP15WB333□03RC	33k	4050 ±3%	4101	4108	4131	0.17	100	1
NCP15WL333□03RC	33k	4485 ±1%	4537	4543	4557	0.17	100	1

Continued on the following page. ↗

⚠Note • Please read rating and ⚠CAUTION (for storage, operating, rating, soldering, mounting and handling) in this catalog to prevent smoking and/or burning, etc.
 • This catalog has only typical specifications. Therefore, please approve our product specifications or transact the approval sheet for product specifications before ordering.

↳ Continued from the preceding page.

Part Number	Resistance (25°C) (ohm)	B-Constant (25-50°C) (K)	B-Constant (25-80°C) (Reference Value) (K)	B-Constant (25-85°C) (Reference Value) (K)	B-Constant (25-100°C) (Reference Value) (K)	Permissible Operating Current (25°C) (mA)	Rated Electric Power (25°C) (mW)	Typical Dissipation Constant (25°C) (mW/°C)
NCP15WB473D03RC	47k ±0.5%	4050 ±0.5%	4101	4108	4131	0.14	100	1
NCP15WB473F03RC	47k ±1%	4050 ±1%	4101	4108	4131	0.14	100	1
NCP15WB473□03RC	47k	4050 ±1%	4101	4108	4131	0.14	100	1
NCP15WL473□03RC	47k	4485 ±1%	4537	4543	4557	0.14	100	1
NCP15WD683□03RC	68k	4150 ±3%	4201	4209	4232	0.12	100	1
NCP15WL683□03RC	68k	4485 ±1%	4537	4543	4557	0.12	100	1
NCP15WF104D03RC	100k ±0.5%	4250 ±0.5%	4303	4311	4334	0.10	100	1
NCP15WF104F03RC	100k ±1%	4250 ±1%	4303	4311	4334	0.10	100	1
NCP15WF104□03RC	100k	4250 ±1%	4303	4311	4334	0.10	100	1
NCP15WL104□03RC	100k	4485 ±1%	4537	4543	4557	0.10	100	1
NCP15WL154□03RC	150k	4485 ±1%	4537	4543	4557	0.08	100	1
NCP15WM154□03RC	150k	4500 ±3%	4571	4582	4614	0.08	100	1
NCP15WM224□03RC	220k	4500 ±3%	4571	4582	4614	0.06	100	1
NCP15WM474□03RC	470k	4500 ±3%	4571	4582	4614	0.04	100	1

□ is filled with resistance tolerance codes (E: ±3%, J: ±5%).

Rated Electric Power shows the required electric power that the thermistor's temperature rise to 125°C by self-heating, at ambient temperature of 25 °C.

Operating Temperature Range: -40°C to +125°C

2

NTC Thermistors

Temperature Sensor and Compensation 0603 (1608) Size

Chip NTC Thermistors' Ni barrier termination provides excellent solderability and their unique construction offers high stability in the application's environment.

■ Features

1. Excellent solderability and high stability in the application's environment
2. Excellent long-term stability
3. High accuracy in resistance and B-constant
4. Flow / Reflow soldering possible
5. Same B-Constant in the same resistance in the three sizes (0805 size / 0603 size / 0402 size)
Downsize is easy for design.
6. NCP series are recognized by UL/cUL.
(UL1434, File No.E137188)



■ Applications

1. Temperature compensation for transistors, ICs, and crystal oscillators in mobile communications
2. Temperature sensor for rechargeable batteries
3. Temperature compensation of LCD
4. Temperature compensation in general use of electric circuits

Part Number	Resistance (25°C) (ohm)	B-Constant (25-50°C) (K)	B-Constant (25-80°C) (Reference Value) (K)	B-Constant (25-85°C) (Reference Value) (K)	B-Constant (25-100°C) (Reference Value) (K)	Permissible Operating Current (25°C) (mA)	Rated Electric Power (25°C) (mW)	Typical Dissipation Constant (25°C) (mW/°C)
NCP18XF101□03RB	100	3250 ±3%	3282	3284	3296	3.10	100	1
NCP18XF151□03RB	150	3250 ±3%	3282	3284	3296	2.50	100	1
NCP18XM221□03RB	220	3500 ±3%	3539	3545	3560	2.10	100	1
NCP18XM331□03RB	330	3500 ±3%	3539	3545	3560	1.70	100	1
NCP18XQ471□03RB	470	3650 ±2%	3688	3693	3706	1.40	100	1
NCP18XQ681□03RB	680	3650 ±3%	3688	3693	3706	1.20	100	1
NCP18XQ102□03RB	1.0k	3650 ±2%	3688	3693	3706	1.00	100	1
NCP18XW152□03RB	1.5k	3950 ±3%	3982	3987	3998	0.81	100	1
NCP18XW222□03RB	2.2k	3950 ±3%	3982	3987	3998	0.67	100	1
NCP18XW332□03RB	3.3k	3950 ±3%	3982	3987	3998	0.55	100	1
NCP18XM472□03RB	4.7k	3500 ±2%	3539	3545	3560	0.46	100	1
NCP18XW472□03RB	4.7k	3950 ±3%	3982	3987	3998	0.46	100	1
NCP18XW682□03RB	6.8k	3950 ±3%	3982	3987	3998	0.38	100	1
NCP18XH103D03RB	10k ±0.5%	3380 ±0.7%	3428	3434	3455	0.31	100	1
NCP18XH103F03RB	10k ±1%	3380 ±1%	3428	3434	3455	0.31	100	1
NCP18XH103□03RB	10k	3380 ±1%	3428	3434	3455	0.31	100	1
NCP18XV103□03RB	10k	3900 ±3%	3930	3934	3944	0.31	100	1
NCP18XW153□03RB	15k	3950 ±3%	3982	3987	3998	0.25	100	1
NCP18XW223□03RB	22k	3950 ±3%	3982	3987	3998	0.21	100	1
NCP18WB333□03RB	33k	4050 ±3%	4101	4108	4131	0.17	100	1
NCP18WB473D03RB	47k ±0.5%	4030 ±0.5%	4101	4108	4131	0.14	100	1
NCP18WB473F10RB	47k ±1%	4050 ±1.5%	4101	4108	4131	0.14	100	1
NCP18WB473□03RB	47k	4050 ±2%	4101	4108	4131	0.14	100	1
NCP18WD683□03RB	68k	4150 ±3%	4201	4209	4232	0.12	100	1
NCP18WF104D03RB	100k ±0.5%	4200 ±0.5%	4255	4260	4282	0.10	100	1
NCP18WF104F12RB	100k ±1%	4200 ±1%	4255	4260	4282	0.10	100	1

Continued on the following page. ↗

⚠Note • Please read rating and ⚠CAUTION (for storage, operating, rating, soldering, mounting and handling) in this catalog to prevent smoking and/or burning, etc.
 • This catalog has only typical specifications. Therefore, please approve our product specifications or transact the approval sheet for product specifications before ordering.

↳ Continued from the preceding page.

Part Number	Resistance (25°C) (ohm)	B-Constant (25-50°C) (K)	B-Constant (25-80°C) (Reference Value) (K)	B-Constant (25-85°C) (Reference Value) (K)	B-Constant (25-100°C) (Reference Value) (K)	Permissible Operating Current (25°C) (mA)	Rated Electric Power (25°C) (mW)	Typical Dissipation Constant (25°C) (mW/°C)
NCP18WF104□03RB	100k	4250 ±2%	4303	4311	4334	0.10	100	1
NCP18WM154□03RB	150k	4500 ±3%	4571	4582	4614	0.08	100	1
NCP18WM224□03RB	220k	4500 ±3%	4571	4582	4614	0.06	100	1
NCP18WM474□03RB	470k	4500 ±3%	4571	4582	4614	0.04	100	1

□ is filled with resistance tolerance codes (E: ±3%, J: ±5%).

Rated Electric Power shows the required electric power that the thermistor's temperature rise to 125°C by self-heating, at ambient temperature of 25 °C.

Operating Temperature Range: -40°C to +125°C

NTC Thermistors

Temperature Sensor and Compensation 0805 (2012) Size

Chip NTC Thermistors' Ni barrier termination provides excellent solderability and their unique construction offers high stability in the application's environment.

■ Features

1. Excellent solderability and high stability in the application's environment
2. Excellent long-term stability
3. High accuracy in resistance and B-constant
4. Flow / Reflow soldering possible
5. Same B-Constant in the same resistance in the three sizes (0805 size / 0603 size / 0402 size)
Downsize is easy for design.
6. NCP series are recognized by UL/cUL.
(UL1434, File No.E137188)



■ Applications

1. Temperature compensation for transistors, ICs, and crystal oscillators in mobile communications
2. Temperature sensor for rechargeable batteries
3. Temperature compensation of LCD
4. Temperature compensation in general use of electric circuits

Part Number	Resistance (25°C) (ohm)	B-Constant (25-50°C) (K)	B-Constant (25-80°C) (Reference Value) (K)	B-Constant (25-85°C) (Reference Value) (K)	B-Constant (25-100°C) (Reference Value) (K)	Permissible Operating Current (25°C) (mA)	Rated Electric Power (25°C) (mW)	Typical Dissipation Constant (25°C) (mW/°C)
NCP21XM221J03RA	220 ±5%	3500 ±3%	3539	3545	3560	3.00	200	2
NCP21XQ471J03RA	470 ±5%	3650 ±3%	3688	3693	3706	2.00	200	2
NCP21XQ102J03RA	1.0k ±5%	3650 ±3%	3688	3693	3706	1.40	200	2
NCP21XW222J03RA	2.2k ±5%	3950 ±3%	3982	3987	3998	0.90	200	2
NCP21XM472J03RA	4.7k ±5%	3500 ±3%	3539	3545	3560	0.65	200	2
NCP21XV103J03RA	10k ±5%	3900 ±3%	3930	3934	3944	0.44	200	2
NCP21XW153J03RA	15k ±5%	3950 ±3%	3982	3987	3998	0.36	200	2
NCP21XW223J03RA	22k ±5%	3950 ±3%	3982	3987	3998	0.30	200	2
NCP21WB333J03RA	33k ±5%	4050 ±3%	4101	4108	4131	0.24	200	2
NCP21WB473J03RA	47k ±5%	4050 ±3%	4101	4108	4131	0.20	200	2
NCP21WF104J03RA	100k ±5%	4250 ±3%	4303	4311	4334	0.14	200	2

Rated Electric Power shows the required electric power that the thermistor's temperature rise to 125°C by self-heating, at ambient temperature of 25 °C.
 Operating Temperature Range: -40°C to +125°C

Temperature Sensor and Compensation Chip Type Standard Land Pattern Dimensions



Part Number	Soldering Methods	Dimensions (mm)			
		Chip (LxW)	a	b	c
NCP03	Reflow Soldering	0.6x0.3	0.25	0.3	0.3
NCP15	Reflow Soldering	1.0x0.5	0.4	0.4-0.5	0.5
NCP18	Flow Soldering	1.6x0.8	0.6-1.0	0.8-0.9	0.6-0.8
	Reflow Soldering		0.6-0.8	0.6-0.7	0.6-0.8
NCP21	Flow Soldering	2.0x1.25	1.0-1.1	0.9-1.0	1.0-1.2
	Reflow Soldering		1.0-1.1	0.6-0.7	1.0-1.2

Temperature Sensor and Compensation Chip Type Temperature Characteristics (Center Value)

Part Number	NCP15XC220	NCP15XC330	NCP15XC470	NCP15XC680	NCP□□XF101	NCP□□XF151	NCP□□XM221	NCP□□XM331
Resistance	22Ω	33Ω	47Ω	68Ω	100Ω	150Ω	220Ω	330Ω
B-Constant	3100K	3100K	3100K	3100K	3250K	3250K	3500K	3500K
Temp. (°C)	Resistance (Ω)	Resistance (Ω)	Resistance (Ω)	Resistance (Ω)	Resistance (Ω)	Resistance (Ω)	Resistance (Ω)	Resistance (Ω)
-40	355.823	533.734	760.166	1099.815	1824.175	2736.262	4947.904	7421.856
-35	273.975	410.962	585.310	846.832	1390.685	2086.028	3703.755	5555.632
-30	213.003	319.504	455.051	658.372	1070.653	1605.979	2798.873	4198.309
-25	166.943	250.415	356.652	516.007	831.138	1246.708	2135.887	3203.831
-20	131.997	197.996	281.994	407.991	650.960	976.440	1645.037	2467.555
-15	105.318	157.978	224.998	325.529	514.441	771.661	1278.034	1917.051
-10	84.670	127.005	180.886	261.707	409.700	614.550	1000.620	1500.930
-5	68.628	102.942	146.614	212.123	328.877	493.315	789.612	1184.418
0	55.981	83.972	119.596	173.033	265.759	398.639	627.752	941.628
5	45.859	68.789	97.972	141.747	215.785	323.677	502.474	753.711
10	37.819	56.728	80.794	116.894	176.395	264.592	405.010	607.514
15	31.396	47.094	67.073	97.042	145.161	217.742	328.480	492.720
20	26.211	39.317	55.997	81.016	120.152	180.228	268.044	402.066
25	22.000	33.000	47.000	68.000	100.000	150.000	220.000	330.000
30	18.560	27.840	39.651	57.368	83.669	125.503	181.576	272.365
35	15.735	23.603	33.616	48.636	70.361	105.541	150.668	226.002
40	13.403	20.104	28.633	41.426	59.456	89.184	125.681	188.521
45	11.462	17.193	24.487	35.428	50.470	75.705	105.336	158.004
50	9.842	14.763	21.026	30.421	43.029	64.543	88.717	133.076
55	8.488	12.732	18.133	26.235	36.830	55.246	75.059	112.588
60	7.348	11.022	15.698	22.712	31.649	47.473	63.777	95.666
65	6.399	9.598	13.670	19.778	27.364	41.045	54.415	81.622
70	5.595	8.392	11.952	17.293	23.756	35.634	46.631	69.946
75	4.896	7.345	10.461	15.134	20.651	30.976	40.115	60.172
80	4.299	6.448	9.184	13.288	18.011	27.016	34.637	51.955
85	3.795	5.692	8.107	11.729	15.800	23.700	30.013	45.019
90	3.360	5.040	7.179	10.386	13.908	20.862	26.110	39.165
95	2.983	4.474	6.373	9.220	12.263	18.394	22.790	34.186
100	2.656	3.983	5.673	8.208	10.844	16.265	19.957	29.935
105	2.367	3.551	5.057	7.317	9.622	14.434	17.541	26.312
110	2.116	3.173	4.520	6.539	8.563	12.844	15.453	23.180
115	1.901	2.851	4.060	5.874	7.648	11.472	13.663	20.494
120	1.712	2.568	3.657	5.291	6.850	10.275	12.114	18.171
125	1.543	2.314	3.296	4.768	6.162	9.243	10.778	16.168

Part Number	NCP□□XQ471	NCP□□XQ681	NCP□□XM102	NCP□□XQ102	NCP□□XM152	NCP□□XW152	NCP□□XM222	NCP□□XW222
Resistance	470Ω	680Ω	1.0kΩ	1.0kΩ	1.5kΩ	1.5kΩ	2.2kΩ	2.2kΩ
B-Constant	3650K	3650K	3500K	3650K	3500K	3950K	3500K	3950K
Temp. (°C)	Resistance (Ω)	Resistance (Ω)	Resistance (kΩ)	Resistance (kΩ)	Resistance (kΩ)	Resistance (kΩ)	Resistance (kΩ)	Resistance (kΩ)
-40	11822.473	17104.854	21.266	25.154	31.899	51.791	46.786	75.961
-35	8767.745	12685.248	16.150	18.655	24.225	37.172	35.530	54.520
-30	6570.224	9505.855	12.347	13.979	18.520	27.005	27.162	39.607
-25	4971.784	7193.219	9.503	10.578	14.255	19.843	20.907	29.103
-20	3796.933	5493.436	7.365	8.079	11.047	14.728	16.203	21.601
-15	2923.400	4229.599	5.747	6.220	8.621	11.044	12.644	16.198
-10	2269.599	3283.675	4.516	4.829	6.773	8.362	9.934	12.264
-5	1775.225	2568.411	3.572	3.777	5.358	6.389	7.858	9.370
0	1399.050	2024.158	2.844	2.977	4.266	4.922	6.257	7.219
5	1110.220	1606.275	2.280	2.362	3.419	3.825	5.015	5.609
10	887.257	1283.691	1.839	1.888	2.758	2.994	4.045	4.391
15	713.463	1032.245	1.492	1.518	2.238	2.361	3.283	3.463
20	577.375	835.351	1.218	1.229	1.827	1.876	2.680	2.751
25	470.000	680.000	1.000	1.000	1.500	1.500	2.200	2.200
30	384.800	556.733	0.825	0.819	1.238	1.207	1.816	1.771
35	316.757	458.287	0.685	0.674	1.027	0.978	1.507	1.434
40	262.177	379.320	0.571	0.558	0.857	0.797	1.257	1.169
45	218.069	315.504	0.479	0.464	0.718	0.653	1.053	0.958
50	182.297	263.749	0.403	0.388	0.605	0.538	0.887	0.789
55	153.150	221.579	0.341	0.326	0.512	0.446	0.751	0.654
60	129.249	186.998	0.290	0.275	0.435	0.371	0.638	0.545
65	109.551	158.499	0.247	0.233	0.371	0.311	0.544	0.456
70	93.281	134.960	0.212	0.199	0.318	0.261	0.466	0.383
75	79.750	115.383	0.182	0.170	0.274	0.221	0.401	0.324
80	68.446	99.029	0.157	0.146	0.236	0.187	0.346	0.275
85	58.996	85.356	0.136	0.126	0.205	0.160	0.300	0.234
90	51.036	73.839	0.119	0.109	0.178	0.137	0.261	0.200
95	44.332	64.140	0.104	0.094	0.155	0.117	0.228	0.172
100	38.640	55.905	0.091	0.082	0.136	0.101	0.200	0.149
105	33.790	48.888	0.080	0.072	0.120	0.088	0.175	0.129
110	29.664	42.918	0.070	0.063	0.105	0.076	0.155	0.112
115	26.123	37.795	0.062	0.056	0.093	0.067	0.137	0.098
120	23.091	33.409	0.055	0.049	0.083	0.058	0.121	0.085
125	20.472	29.618	0.049	0.044	0.074	0.051	0.108	0.075

Detailed Resistance - Temperature Tables are downloadable from the following URL.
<http://search.murata.co.jp/Ceramy/CatsearchAction.do?sLang=en>

Continued on the following page.

Temperature Sensor and Compensation Chip Type Temperature Characteristics (Center Value)

Continued from the preceding page.

Part Number	NCP□□XM332	NCP□□XW332	NCP□□XM472	NCP□□XW472	NCP□□XH682	NCP□□XW682	NCP□□XH103D	NCP□□XH103
Resistance	3.3kΩ	3.3kΩ	4.7kΩ	4.7kΩ	6.8kΩ	6.8kΩ	10kΩ±0.5%	10kΩ
B-Constant	3500K	3950K	3500K	3950K	3380K	3950K	3380K	3380K
Temp. (°C)	Resistance (kΩ)	Resistance (kΩ)	Resistance (kΩ)	Resistance (kΩ)	Resistance (kΩ)	Resistance (kΩ)	Resistance (kΩ)	Resistance (kΩ)
-40	70.179	113.941	105.705	162.279	133.043	234.787	197.390	195.652
-35	53.295	81.779	79.126	116.474	100.756	168.515	149.390	148.171
-30	40.743	59.411	59.794	84.615	77.076	122.422	114.340	113.347
-25	31.360	43.654	45.630	62.173	59.540	89.953	88.381	87.559
-20	24.304	32.401	35.144	46.147	46.401	66.766	68.915	68.237
-15	18.966	24.297	27.303	34.604	36.482	50.066	54.166	53.650
-10	14.901	18.396	21.377	26.200	28.904	37.906	42.889	42.506
-5	11.787	14.055	16.869	20.018	23.047	28.963	34.196	33.892
0	9.386	10.829	13.411	15.423	18.509	22.313	27.445	27.219
5	7.523	8.414	10.735	11.984	14.974	17.338	22.165	22.021
10	6.067	6.586	8.653	9.380	12.189	13.571	18.010	17.926
15	4.924	5.195	7.018	7.399	9.978	10.705	14.720	14.674
20	4.019	4.126	5.726	5.877	8.215	8.503	12.099	12.081
25	3.300	3.300	4.700	4.700	6.800	6.800	10.000	10.000
30	2.724	2.656	3.879	3.783	5.654	5.474	8.309	8.315
35	2.260	2.152	3.219	3.064	4.725	4.434	6.939	6.948
40	1.885	1.753	2.685	2.497	3.967	3.613	5.824	5.834
45	1.580	1.437	2.250	2.046	3.344	2.961	4.911	4.917
50	1.331	1.184	1.895	1.686	2.829	2.440	4.160	4.161
55	1.126	0.981	1.604	1.397	2.404	2.022	3.539	3.535
60	0.957	0.817	1.363	1.164	2.050	1.683	3.024	3.014
65	0.816	0.684	1.163	0.974	1.759	1.409	2.593	2.586
70	0.700	0.575	0.996	0.819	1.515	1.185	2.233	2.228
75	0.602	0.486	0.857	0.692	1.309	1.001	1.929	1.925
80	0.520	0.412	0.740	0.587	1.135	0.849	1.673	1.669
85	0.450	0.351	0.641	0.500	0.988	0.724	1.455	1.452
90	0.392	0.301	0.558	0.428	0.862	0.620	1.270	1.268
95	0.342	0.258	0.487	0.368	0.755	0.532	1.112	1.110
100	0.299	0.223	0.426	0.318	0.662	0.459	0.976	0.974
105	0.263	0.193	0.375	0.275	0.583	0.398	0.860	0.858
110	0.232	0.168	0.330	0.239	0.515	0.346	0.759	0.758
115	0.205	0.146	0.292	0.208	0.457	0.302	0.673	0.672
120	0.182	0.128	0.259	0.182	0.406	0.264	0.598	0.596
125	0.162	0.113	0.230	0.160	0.361	0.232	0.532	0.531

Part Number	NCP□□XV103	NCP□□XH153	NCP□□XW153	NCP□□XH223	NCP□□XW223	NCP□□WL223	NCP□□WB333	NCP□□WF333
Resistance	10kΩ	15kΩ	15kΩ	22kΩ	22kΩ	22kΩ	33kΩ	33kΩ
B-Constant	3900K	3380K	3950K	3380K	3950K	4485K	4050K	4250K
Temp. (°C)	Resistance (kΩ)	Resistance (kΩ)	Resistance (kΩ)	Resistance (kΩ)	Resistance (kΩ)	Resistance (kΩ)	Resistance (kΩ)	Resistance (kΩ)
-40	328.996	293.478	517.912	430.434	759.605	1073.436	1227.263	1451.049
-35	237.387	222.256	371.724	325.976	545.196	753.900	874.449	1019.238
-30	173.185	170.021	270.048	249.364	396.070	535.073	630.851	725.084
-25	127.773	131.338	198.426	192.629	291.025	383.590	460.457	522.021
-20	95.327	102.355	147.278	150.121	216.008	277.643	339.797	379.842
-15	71.746	80.474	110.439	118.029	161.977	202.813	253.363	279.371
-10	54.564	63.759	83.617	93.514	122.638	149.462	190.766	207.566
-5	41.813	50.838	63.888	74.563	93.702	111.082	144.964	155.639
0	32.330	40.828	49.221	59.881	72.191	83.233	111.087	117.814
5	25.194	33.032	38.245	48.446	56.093	62.858	85.842	89.925
10	19.785	26.888	29.936	39.436	43.907	47.831	66.861	69.204
15	15.651	22.010	23.613	32.282	34.633	36.664	52.470	53.675
20	12.468	18.121	18.756	26.577	27.509	28.304	41.471	41.937
25	10.000	15.000	15.000	22.000	22.000	22.000	33.000	33.000
30	8.072	12.472	12.074	18.292	17.709	17.214	26.430	26.143
35	6.556	10.422	9.780	15.285	14.344	13.557	21.298	20.845
40	5.356	8.751	7.969	12.834	11.688	10.744	17.266	16.723
45	4.401	7.375	6.531	10.817	9.578	8.566	14.076	13.498
50	3.635	6.241	5.382	9.154	7.894	6.871	11.538	10.954
55	3.019	5.302	4.459	7.777	6.540	5.544	9.506	8.940
60	2.521	4.521	3.713	6.631	5.446	4.498	7.870	7.334
65	2.115	3.879	3.108	5.690	4.559	3.669	6.549	6.046
70	1.781	3.341	2.613	4.901	3.832	3.009	5.475	5.011
75	1.509	2.887	2.208	4.234	3.239	2.479	4.595	4.170
80	1.284	2.503	1.873	3.671	2.748	2.052	3.874	3.487
85	1.097	2.178	1.597	3.195	2.342	1.707	3.282	2.928
90	0.941	1.902	1.367	2.790	2.004	1.426	2.789	2.469
95	0.810	1.664	1.174	2.441	1.722	1.196	2.379	2.091
100	0.701	1.461	1.013	2.142	1.486	1.008	2.038	1.777
105	0.608	1.287	0.878	1.888	1.287	0.852	1.751	1.516
110	0.530	1.137	0.763	1.668	1.119	0.724	1.509	1.298
115	0.463	1.007	0.665	1.477	0.975	0.617	1.306	1.116
120	0.406	0.895	0.582	1.312	0.854	0.528	1.134	0.962
125	0.358	0.797	0.511	1.169	0.750	0.454	0.987	0.832

Detailed Resistance - Temperature Tables are downloadable from the following URL.
<http://search.murata.co.jp/Ceramy/CatsearchAction.do?sLang=en>

Continued on the following page.

Temperature Sensor and Compensation Chip Type Temperature Characteristics (Center Value)

Continued from the preceding page.

Part Number	NCP□□WL333	NCP15WB473D	NCP18WB473D	NCP□□WB473	NCP□□WL473	NCP□□WD683	NCP□□WF683	NCP□□WL683
Resistance	33kΩ	47kΩ	47kΩ	47kΩ	47kΩ	68kΩ	68kΩ	68kΩ
B-Constant	4485K	4050K	4030K	4050K	4485K	4150K	4250K	4485K
Temp. (°C)	Resistance (kΩ)	Resistance (kΩ)	Resistance (kΩ)	Resistance (kΩ)	Resistance (kΩ)	Resistance (kΩ)	Resistance (kΩ)	Resistance (kΩ)
-40	1610.154	1690.586	1743.085	1747.920	2293.249	2735.359	2990.041	3317.893
-35	1130.850	1215.318	1241.814	1245.428	1610.605	1937.391	2100.247	2330.237
-30	802.609	882.908	896.201	898.485	1143.110	1389.345	1494.113	1653.862
-25	575.385	647.911	654.460	655.802	819.487	1008.014	1075.679	1185.641
-20	416.464	480.069	483.172	483.954	593.146	738.978	782.705	858.168
-15	304.219	359.009	360.367	360.850	433.281	547.456	575.674	626.875
-10	224.193	270.868	271.363	271.697	319.305	409.600	427.712	461.974
-5	166.623	206.113	206.204	206.463	237.312	309.217	320.710	343.345
0	124.850	158.126	158.051	158.214	177.816	235.606	242.768	257.266
5	94.287	122.267	122.145	122.259	134.287	180.980	185.300	194.287
10	71.747	95.256	95.145	95.227	102.184	140.139	142.603	147.841
15	54.996	74.754	74.676	74.730	78.327	109.344	110.602	113.325
20	42.455	59.075	59.038	59.065	60.467	85.929	86.415	87.484
25	33.000	47.000	47.000	47.000	47.000	68.000	68.000	68.000
30	25.822	37.636	37.667	37.643	36.776	54.167	53.871	53.208
35	20.335	30.326	30.381	30.334	28.962	43.421	42.954	41.903
40	16.115	24.583	24.654	24.591	22.952	35.016	34.460	33.208
45	12.849	20.043	20.124	20.048	18.301	28.406	27.814	26.477
50	10.306	16.433	16.518	16.433	14.679	23.166	22.572	21.237
55	8.317	13.545	13.631	13.539	11.845	18.997	18.422	17.137
60	6.748	11.223	11.306	11.209	9.610	15.657	15.113	13.904
65	5.504	9.345	9.424	9.328	7.839	12.967	12.459	11.342
70	4.513	7.818	7.892	7.798	6.427	10.794	10.325	9.299
75	3.718	6.571	6.639	6.544	5.296	9.021	8.592	7.662
80	3.078	5.548	5.609	5.518	4.384	7.575	7.185	6.343
85	2.560	4.704	4.759	4.674	3.646	6.387	6.033	5.276
90	2.139	4.004	4.054	3.972	3.046	5.407	5.087	4.407
95	1.794	3.422	3.468	3.388	2.555	4.598	4.309	3.697
100	1.511	2.936	2.977	2.902	2.152	3.922	3.661	3.114
105	1.278	2.528	2.566	2.494	1.820	3.359	3.124	2.634
110	1.085	2.184	2.220	2.150	1.546	2.887	2.675	2.236
115	0.925	1.893	1.927	1.860	1.318	2.489	2.299	1.907
120	0.792	1.646	1.679	1.615	1.128	2.155	1.983	1.632
125	0.681	1.436	1.468	1.406	0.970	1.870	1.715	1.403

Part Number	NCP15WF104D	NCP18WF104D/F	NCP□□WF104	NCP□□WL104	NCP□□WL154	NCP□□WM154	NCP□□WL224	NCP□□WM224
Resistance	100kΩ±0.5%	100kΩ±1%	100kΩ	100kΩ	150kΩ	150kΩ	220kΩ	220kΩ
B-Constant	4250K	4200K	4250K	4485K	4485K	4500K	4485K	4500K
Temp. (°C)	Resistance (kΩ)	Resistance (kΩ)	Resistance (kΩ)	Resistance (kΩ)	Resistance (kΩ)	Resistance (kΩ)	Resistance (kΩ)	Resistance (kΩ)
-40	4221.283	4205.686	4397.119	4879.254	7318.881	7899.466	10734.358	11585.884
-35	2995.044	2966.436	3088.599	3426.818	5140.228	5466.118	7539.001	8016.973
-30	2146.996	2118.789	2197.225	2432.149	3648.224	3834.499	5350.729	5623.931
-25	1554.599	1531.319	1581.881	1743.590	2615.385	2720.523	3835.898	3990.100
-20	1136.690	1118.422	1151.037	1262.012	1893.018	1951.216	2776.427	2861.784
-15	839.019	825.570	846.579	921.875	1382.813	1415.565	2028.126	2076.162
-10	624.987	615.526	628.988	679.373	1019.059	1036.984	1494.620	1520.909
-5	469.678	463.104	471.632	504.919	757.379	767.079	1110.822	1125.049
0	355.975	351.706	357.012	378.333	567.499	572.667	832.332	839.912
5	272.011	269.305	272.500	285.717	428.575	431.264	628.577	632.521
10	209.489	207.891	209.710	217.414	326.121	327.405	478.310	480.194
15	162.559	161.722	162.651	166.654	249.981	250.538	366.639	367.455
20	127.057	126.723	127.080	128.653	192.979	193.166	283.036	283.310
25	100.000	100.000	100.000	100.000	150.000	150.000	220.000	220.000
30	79.222	79.439	79.222	78.247	117.370	117.281	172.143	172.012
35	63.167	63.509	63.167	61.622	92.433	92.293	135.569	135.364
40	50.677	51.084	50.677	48.835	73.252	73.090	107.436	107.198
45	40.904	41.336	40.904	38.937	58.406	58.240	85.662	85.419
50	33.195	33.628	33.195	31.231	46.846	46.665	68.708	68.441
55	27.091	27.510	27.091	25.202	37.803	37.605	55.444	55.153
60	22.224	22.621	22.224	20.448	30.671	30.453	44.984	44.665
65	18.323	18.692	18.323	16.679	25.018	24.804	36.694	36.379
70	15.184	15.525	15.184	13.675	20.513	20.293	30.085	29.763
75	12.635	12.947	12.635	11.268	16.902	16.679	24.789	24.462
80	10.566	10.849	10.566	9.329	13.993	13.776	20.523	20.205
85	8.873	9.129	8.873	7.758	11.638	11.428	17.068	16.761
90	7.481	7.713	7.481	6.481	9.721	9.520	14.258	13.962
95	6.337	6.546	6.337	5.437	8.155	7.966	11.961	11.684
100	5.384	5.572	5.384	4.580	6.869	6.688	10.075	9.809
105	4.594	4.764	4.594	3.873	5.810	5.639	8.521	8.270
110	3.934	4.087	3.934	3.289	4.933	4.772	7.236	6.998
115	3.380	3.518	3.380	2.804	4.206	4.052	6.169	5.942
120	2.916	3.040	2.916	2.400	3.601	3.454	5.281	5.067
125	2.522	2.634	2.522	2.064	3.096	2.955	4.540	4.334

Detailed Resistance - Temperature Tables are downloadable from the following URL.
<http://search.murata.co.jp/Ceramy/CatsearchAction.do?sLang=en>

Continued on the following page. ↗

Temperature Sensor and Compensation Chip Type Temperature Characteristics (Center Value)

↳ Continued from the preceding page.

Part Number	NCP□□WM474
Resistance	470kΩ
B-Constant	4500K
Temp. (°C)	Resistance (kΩ)
-40	24751.661
-35	17127.169
-30	12014.762
-25	8524.305
-20	6113.811
-15	4435.437
-10	3249.216
-5	2403.515
0	1794.358
5	1351.294
10	1025.870
15	785.018
20	605.252
25	470.000
30	367.480
35	289.186
40	229.014
45	182.485
50	146.215
55	117.828
60	95.420
65	77.718
70	63.584
75	52.260
80	43.166
85	35.808
90	29.828
95	24.961
100	20.955
105	17.668
110	14.951
115	12.695
120	10.824
125	9.259

Detailed Resistance - Temperature Tables are downloadable from the following URL.
<http://search.murata.co.jp/Ceramy/CatsearchAction.do?sLang=en>

Temperature Sensor and Compensation Chip Type ⚠Caution/Notice

■ ⚠Caution (Storage and Operating Conditions)

This product is designed for application in an ordinary environment (normal room temperature, humidity and atmospheric pressure).

Do not use under the following conditions because all of these factors can deteriorate the product characteristics or cause failures and burn-out.

1. Corrosive gas or deoxidizing gas

(Chlorine gas, Hydrogen sulfide gas, Ammonia gas, Sulfuric acid gas, Nitric oxide gas, etc.)

2. Volatile or flammable gas

3. Dusty conditions

4. Under vacuum, or under high or low pressure

5. Wet or humid locations

6. Places with salt water, oils, chemical liquids or organic solvents

7. Strong vibrations

8. Other places where similar hazardous conditions exist

■ ⚠Caution (Others)

Be sure to provide an appropriate fail-safe function on your product to prevent secondary damage that may be caused by the abnormal function or the failure of our product.

■ Notice (Storage and Operating Conditions)

To keep the solderability of the product from degrading, the following storage conditions are recommended.

1. Storage condition:

Temperature -10 to +40°C

Humidity less than 75%RH (not dewing condition)

2. Storage term:

Use this product within 6 months after delivery by first-in and first-out stocking system.

3. Storage place:

Do not store this product in corrosive gas (Sulfuric acid gas, Chlorine gas, etc.) or in direct sunlight.

■ Notice (Rating)

Use this product within the specified temperature range.

Higher temperature may cause deterioration of the characteristics or the material quality of this product.

■ Notice (Handling)

The ceramic of this product is fragile, and care must be taken not to load an excessive press-force or to cause a shock at handling.

Such forces may cause cracking or chipping.

Temperature Sensor and Compensation Chip Type ⚠Caution/Notice

■ Notice (Soldering and Mounting)

1. Mounting Position

Choose a mounting position that minimizes the stress imposed on the chip during flexing or bending of the board.



2. Allowable Soldering Temperature and Time

- (a) Solder within the temperature and time combinations indicated by the slanted lines in the following graphs.
- (b) Excessive soldering conditions may cause dissolution of metallization or deterioration of solder-wetting on the external electrode.
- (c) In case of repeated soldering, the accumulated soldering time should be within the range shown in the figure below. (For example, Reflow peak temperature: 260°C, twice -> The total accumulated soldering time at 260°C is within 30 seconds.)



Continued on the following page.

Temperature Sensor and Compensation Chip Type ⚠Caution/Notice

☐ Continued from the preceding page.

3. Recommended Temperature Profile for Soldering

- (a) Insufficient preheating may cause a crack on the ceramic body. The difference between preheating temperature and maximum temperature in the profile shall be 100 °C.
 (b) Rapid cooling by dipping in solvent or by other means is not recommended.

* In case of repeated soldering, the accumulated soldering time should be within the range shown in the figure of section 2.

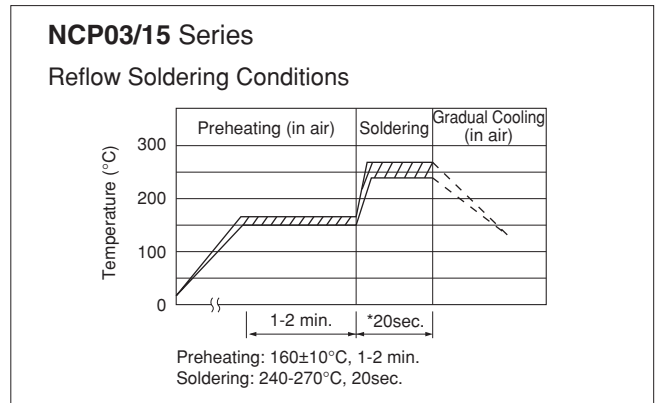

4. Solder and Flux

(1) Solder and Paste

(a) Reflow Soldering: NCP03/15/18/21 Series

Use RA/RMA type or equivalent type of solder paste. For your reference, we use the solder paste below for any internal tests of this product.

- RMA9086 90-4-M20 (Sn:Pb=63wt%:37wt%)
 (Manufactured by Alpha Metals Japan Ltd.)
- M705-221BM5-42-11 (Sn:Ag:Cu=96.5wt%:3.0wt%:0.5wt%)
 (Manufactured by Senju Metal Industry Co., Ltd.)

(b) Flow Soldering: NCP18/21 Series

We use the solder paste below for any internal tests of this product.

- Sn:Pb=63wt%:37wt%
- Sn:Ag:Cu=96.5wt%:3.0wt%:0.5wt%

(2) Flux

Use rosin type flux in the soldering process.

If the flux listed below is used, some problems might be caused in the product characteristics and reliability.

Please do not use the following flux.

- Strong acidic flux (with halide content exceeding 0.1wt%).
- Water-soluble flux
 (*Water-soluble flux can be defined as non-rosin type flux including wash-type flux and non-wash-type flux.)

5. Cleaning Conditions

For removing the flux after soldering, observe the following points in order to avoid deterioration of the characteristics or any change of the external electrodes' quality.

- Please keep mounted parts and a substrate from an occurrence of resonance in ultrasonic cleaning.
- Please do not clean the products in the case of using a non-wash-type flux.

	NCP03/15	NCP18/21
Solvent	Isopropyl Alcohol	Isopropyl Alcohol
Dipping Cleaning	Less than 5 minutes at room temp. or less than 2 minutes at 40°C max.	Less than 5 minutes at room temp. or less than 2 minutes at 40°C max.
Ultrasonic Cleaning	Less than 5 minutes and 20W/ℓ Frequency of 28kHz to 40kHz	Less than 1 minute and 20W/ℓ Frequency of several 10kHz to 100kHz

6. Drying

After cleaning, promptly dry this product.

Continued on the following page. ☐

Temperature Sensor and Compensation Chip Type ⚠Caution/Notice

☐ Continued from the preceding page.

7. Printing Conditions of Solder Paste

- The amount of solder is critical. Standard height of fillet is shown in the table below.
- Too much solder may cause mechanical stress, resulting in cracking, mechanical and/or electronic damage.



Part Number	Solder Paste Thickness	T
NCP03	100μm	$1/3E \leq T \leq E$
NCP15	150μm	$1/3E \leq T \leq E$
NCP18/NCP21	200μm	$0.2\text{mm} \leq T \leq E$

8. Adhesive Application and Curing

- Thin or insufficient adhesive may result in loose component contact with land during flow soldering.
- Low viscosity adhesive causes chips to slip after mounting.

Temperature Sensor and Compensation Chip Type Package

■ Minimum Quantity Guide

Part Number	Quantity (pcs.)	
	Paper Tape	Embossed Tape
NCP03	15,000	-
NCP15	10,000	
NCP18	4,000	
NCP21	-	4,000

■ Tape Carrier Packaging

1. Dimensions of Reel



2. Taping Method

- (1) A tape in a reel contains Leader unit and Trailer unit where products are not packed. (Please refer to the figure at the right.)
- (2) The top and base tapes or plastic and cover tape are not stuck at the first five pitches minimum.
- (3) A label should be attached on the reel. (MURATA's part number, inspection number and quantity should be marked on the label.)
- (4) Taping reels are packed in a package.



Continued on the following page.

Temperature Sensor and Compensation Chip Type Package

↳ Continued from the preceding page.

3. Paper Tape (NCP03/15/18 Series)



(1) Other Conditions

(a) Packaging

Products are packaged in the cavity of the base tape and sealed by a top tape and bottom tape.

(b) Tape

The top tape and bottom tape have no joints and products are packaged and sealed in the cavity of the base tape, continuously.

(2) Peeling Force of Top Tape



(3) Pull Strength

Pull strength of top tape is specified at 10N minimum.

Pull strength of bottom tape should be specified 5N minimum.

Continued on the following page. ↗

Temperature Sensor and Compensation Chip Type Package

☐ Continued from the preceding page.

4. Embossed Tape (NCP21 Series)

(1) Other Conditions

(a) Packaging

Products are packaged in the each cavity of Embossed tape and sealed by Cover tape.

(b) Tape

Cover tape has no joints.



(2) Peeling Force of Cover Tape



(3) Tape Strength

Pull strength of Embossed tape and Cover tape should be specified 10N minimum.

NTC Thermistors

Temperature Sensor Thermo String Type

This product is a small flexible lead type NTC Thermistor with a small head and a thin lead wire.

■ Features

1. This small and highly accurate NTC Thermistor provides extremely precise temperature sensing.
2. The small sensing head and thin lead wire deliver temperature sensing in a narrow space.
3. Flexibility and a wide variety of lengths (25mm to 150mm) enable the design of flexible temperature sensing architectures.
4. This product is compatible with our 0402 (EIA) size chip Thermistor.
5. Excellent long-term stability
6. This is a halogen free product. *
 * Cl= max.900ppm, Br=max.900ppm and
 Cl+Br=max.1500ppm
7. NXFT series are recognized by UL/cUL.
 (UL1434, File No.E137188).

■ Applications

1. Temperature compensation for transistors, ICs, and crystal oscillators in mobile communications
2. Temperature sensor for rechargeable batteries
3. Temperature compensation of LCD
4. Temperature compensation in general use of electric circuits



NXFT15_1B Type (twist)



NXFT15_2B Type (without twist)

Part Number	Resistance (25°C) (ohm)	B-Constant (25-50°C) (K)	B-Constant (25-80°C) (Reference Value) (K)	B-Constant (25-85°C) (Reference Value) (K)	B-Constant (25-100°C) (Reference Value) (K)	Operating Current for Sensor (25°C) (mA)	Rated Electric Power (25°C) (mW)	Typical Dissipation Constant (25°C) (mW/°C)	Thermal Time Constant (25°C) (s)
NXFT15XH103FA□B□□□	10k ±1%	3380 ±1%	3428	3434	3455	0.12	7.5	1.5	4
NXFT15XV103FA□B□□□	10k ±1%	3936 ±1%	3971	3977	3988	0.12	7.5	1.5	4
NXFT15WB473FA□B□□□	47k ±1%	4050 ±1%	4101	4108	4131	0.06	7.5	1.5	4
NXFT15WF104FA□B□□□	100k ±1%	4250 ±1%	4303	4311	4334	0.04	7.5	1.5	4

□ is filled with lead shape (1: twist, 2: without twist).

□□□ is filled with Total-length codes. (25mm, 30 to 150mm interval 10mm, ex. 050=50mm)

Operating Current for Sensor rises Thermistor's temperature by 0.1°C

Rated Electric Power shows the required electric power that the thermistor's temperature rise to 30°C by self-heating, at ambient temperature of 25 °C.

Operating Temperature Range: -40°C to +125°C

Temperature Sensor Thermo String Type Specifications and Test Methods

No.	Item	Specifications	Test Methods
1	High Temperature Storage Test	<ul style="list-style-type: none"> · Resistance (R25°C) fluctuation rate: less than ±1%. · B-Constant (B25/50°C) fluctuation rate: less than ±1%. 	125±2°C in air, for 1000 +48/-0 hours without loading.
2	Low Temperature Storage Test		-40 +0/-3°C in air, for 1000 +48/-0 hours without loading.
3	Humidity Storage Test		60±2°C, 90 to 95%RH in air, for 1000 +48/-0 hours without loading.
4	Temperature Cycle	<ul style="list-style-type: none"> · Resistance (R25°C) fluctuation rate: less than ±2%. · B-Constant (B25/50°C) fluctuation rate: less than ±1%. 	-40 +0/-3°C, 30 minutes in air +25±2°C, 10 to 15 minutes in air +125±2°C, 30 minutes in air +25 +2/-0°C, 10 to 15 minutes in air (1 cycle) Continuous 100 cycles, without loading.
5	High Temperature Load		85±2°C in air, with 'Operating Current for Sensor' for 1000 +48/-0 hrs.
6	Insulation Break - down Voltage	· No damage electrical characteristics at DC100 V, 1 min.	2mm length of coating resin from the top of Thermistor is to be dipped into beads of lead (Pb), and DC100V 1 minute is applied to circuit between beads of lead (Pb) and lead wire.
7	Resistance to Soldering Heat	<ul style="list-style-type: none"> · Resistance (R25°C) fluctuation rate: less than ±1%. · B-Constant (B25/50°C) fluctuation rate: less than ±1%. 	Both lead wires are dipped into 350±10°C solder for 3.5±0.5 seconds, or 260±5°C solder for 10±1 seconds according to Fig-1 (solder <JIS Z 3282 SnAgCu>).  Fig-1
8	Solderability	More than 90% of lead wire surface shall be covered by solder.	Both lead wires are dipped into flux (25wt% colophony <JIS K 5902> isopropyl alcohol <JIS K 8839>) for 5 to 10 seconds. Then both lead wires are dipped into 245±5°C solder <JIS Z 3282 SnAgCu> for 2±0.5 seconds according to Fig-1.
9	Lead Wire Pull Strength	<ul style="list-style-type: none"> · Resistance (R25°C) fluctuation rate: less than ±1%. · B-Constant (B25/50°C) fluctuation rate: less than ±1%. 	The lead wire shall be inserted in a ø1.0mm hole until resin part contacts with a substrate as shown in fig.-2, and 1N force for 10 seconds shall be applied to the lead wire.  Fig-2
10	Lead Wire Bending Strength	· Lead wire does not break.	Hold the lead wires as in Fig-3. Bend by 90 degrees and again bend back to the initial position. Then bend to the other side by 90 degrees and again bend back to the initial position. After bending process, 10N force for 3 seconds shall be applied to the lead wire.  Fig-3

* · R25 is zero-power resistance at 25°C.
 · B25/50 is calculated by zero-power resistance of Thermistor in 25°C-50°C.
 · After each test, NTC Thermistor should be kept for 1 hour at room temperature (normal humidity and normal atmospheric pressure).

Temperature Sensor Thermo String Type Specifications and Test Methods

☐ Continued from the preceding page.

No.	Item	Specifications	Test Methods
11	Free Fall		NTC Thermistor shall be dropped without any force onto concrete floor from 1 meter height one time.
12	Vibration	<ul style="list-style-type: none"> · Resistance (R25°C) fluctuation rate: less than ±1%. · B-Constant (B25/50°C) fluctuation rate: less than ±1%. · No visible damage at resin part. 	<p>NTC Thermistor shall be fixed to the vibration test equipment. Vibration of total 1.5 mm amplitude, Frequency sequence of 10Hz - 55Hz - 10Hz in 1 minute shall be applied for right angled 3 directions for 2 hours duration each.</p> 

- * · R25 is zero-power resistance at 25°C.
- B25/50 is calculated by zero-power resistance of Thermistor in 25°C-50°C.
- After each test, NTC Thermistor should be kept for 1 hour at room temperature (normal humidity and normal atmospheric pressure).

NTC Thermistors

Temperature Sensor Lead Type

This thermistor is for normal temperature level sensors having self-subsistence due to strong lead strength based on chip NTC.

■ Features

1. This highly accurate NTC Thermistor provides extremely precise temperature sensing.
2. This product is compatible with 1005 (1.0mm x 0.5mm) size NTC Thermistor.
3. The variation per hour of this product is highly stable.
4. This product is produced with an automation line that was consistent from lead to packaging so that a product of uniform quality may be obtained at low cost in large quantities.
5. Since this product has strong lead intensity with original lead mounting technique, it is bent at the time of use and can withstand processing, etc., readily.
Taping package can be supported.



■ Applications

1. For temperature detection of a rechargeable battery pack
2. For temperature detection of a charge circuit
3. For temperature detection of a printer head
4. For temperature detection of a DC fan motor
5. For temperature detection of home electronics

6

Part Number	Resistance (25°C) (ohm)	B-Constant (25-50°C) (K)	B-Constant (25-80°C) (Reference Value) (K)	B-Constant (25-85°C) (Reference Value) (K)	B-Constant (25-100°C) (Reference Value) (K)	Operating Current for Sensor (25°C) (mA)	Rated Electric Power (25°C) (mW)	Typical Dissipation Constant (25°C) (mW/°C)	Thermal Time Constant (25°C) (s)
NXRT15XM202EA1B□□□□	2k ±3%	3500 ±1%	3539	3545	3560	0.27	7.5	1.5	4
NXRT15XV502FA1B□□□□	5k ±1%	3936 ±1%	3972	3977	3989	0.17	7.5	1.5	4
NXRT15XH103FA1B□□□□	10k ±1%	3380 ±1%	3428	3434	3455	0.12	7.5	1.5	4
NXRT15XV103FA1B□□□□	10k ±1%	3936 ±1%	3971	3977	3988	0.12	7.5	1.5	4
NXRT15WB333JA1B□□□□	33k ±5%	4050 ±3%	4101	4108	4131	0.07	7.5	1.5	4
NXRT15WB473FA1B□□□□	47k ±1%	4050 ±1%	4101	4108	4131	0.06	7.5	1.5	4
NXRT15WF104FA1B□□□□	100k ±1%	4250 ±1%	4303	4311	4334	0.04	7.5	1.5	4

□□□□ is filled with Total-length codes. (10 to 40mm interval 10mm, ex. 040=40mm)

Operating Current for Sensor rises Thermistor's temperature by 0.1°C.

Rated Electric Power is necessary electric power that thermistor's temperature rises 5°C by self-heating at 25°C in still air.

Taping type of part numbers with "3A016" is available (Lead Spacing=5mm).

Operating Temperature Range: -40°C to +125°C

Temperature Sensor Lead Type Specifications and Test Methods

No.	Item	Specifications	Test Methods
1	Low Temperature Storage Test	<ul style="list-style-type: none"> · Resistance (R25°C) fluctuation rate: less than ±1%. · B-Constant (B25/50°C) fluctuation rate: less than ±1%. 	-40 +0/-3°C in air, for 1000 +48/-0 hours without loading.
2	High Temperature Storage Test		125±2°C in air, for 1000 +48/-0 hours without loading.
3	High Temperature Load	<ul style="list-style-type: none"> · Resistance (R25°C) fluctuation rate: less than ±2%. · B-Constant (B25/50°C) fluctuation rate: less than ±1%. 	85±2°C in air, with 'Operating Current for Sensor' for 1000 +48/-0 hrs.
4	Humidity Storage Test		60±2°C, 90 to 95%RH in air, for 1000 +48/-0 hours without loading.
5	Temperature Cycle		-40°C +0/-3°C, 30 minutes in air +25°C±2°C, 10 to 15 minutes in air +125°C +3/-0°C, 30 minutes in air +25°C +2/-0°C, 10 to 15 minutes in air (1 cycle) Continuous 100 cycles, without loading.
6	Insulation Break - down Voltage	<ul style="list-style-type: none"> · No damage electrical characteristics on D.C.100 V, 1 min. 	2mm length of coating resin from the top of thermistor is to be dipped into beads of lead (Pb), and DC100V 1 minute is applied to circuit between beads of lead (Pb) and lead wire.
7	Resistance to Soldering Heat	<ul style="list-style-type: none"> · Resistance (R25°C) fluctuation rate: less than ±1%. · B-Constant (B25/50°C) fluctuation rate: less than ±1%. 	Both lead wires are dipped into 350±10°C solder for 3.5±0.5 seconds, or 260±5°C solder for 10±1 seconds according to Fig-1. (solder <Sn-3Ag-0.5Cu>)  Fig-1
8	Solderability	<ul style="list-style-type: none"> · More than 90% of lead wire surface shall be covered by solder. 	Both lead wires are dipped into flux (25wt% colophony <JIS K 5902> isopropyl alcohol <JIS K 8839>) for 5 to 10 seconds. Then both lead wires are dipped into 245±5°C solder <Sn-3Ag-0.5Cu> for 2±0.5 seconds according to Fig-1.
9	Lead Wire Pull Strength	<ul style="list-style-type: none"> · Resistance(R25°C) fluctuation rate: less than ±1%. · B-Constant(B25/50°C) fluctuation rate: less than ±1%. · No visible damage at resin part. 	One end of a lead wire shall be fixed and 2.5N force for 10 seconds shall be applied to the other lead wire as shown in Fig-2.  Fig-2
10	Lead Wire Bending Strength	<ul style="list-style-type: none"> · Lead wire does not break. 	One lead wire is held and 2.5N force is applied. Then the body of NTC thermistor is bent by 90° and again bent back to the initial position. This sequence shall be completed twice. See Fig-3.  Fig-3
11	Free Fall	<ul style="list-style-type: none"> · Resistance (R25°C) fluctuation rate: less than ±1%. · B-Constant (B25/50°C) fluctuation rate: less than ±1%. · No visible damage at resin part. 	NTC thermistor shall be dropped without any force onto concrete floor from 1 meter height one time.
12	Vibration		NTC thermistor shall be fixed to the vibration test Equipment. Vibration of total 1.5mm amplitude, Frequency sequence of 10Hz – 55Hz – 10Hz in 1 minute, shall be applied for right angled 3 directions for 2 hours duration each.

* · R25 is zero-power resistance at 25°C.
 · B25/50 is calculated by zero-power resistance of Thermistor in 25°C-50°C.
 · After each test, NTC Thermistor should be kept for 1 hour at room temperature (normal humidity and normal atmospheric pressure).

NTC Thermistors

Temperature Sensor Lead Insulation Type (Radial Type)

This thermistor is for normal temperature level sensors having self-subsistence due to strong lead strength based on chip NTC.

■ Features

1. NXR series can accurately detect temperature with NCP15 series on the head of parts.
2. The insulation coat with polyurethane on the surface of lead wire : 100VDC.
3. You can choose NTC characteristics from NCP15 series.
4. The resistance drift is low in the reliability test.
5. The production capacity is bigger and NXR is produced almost entirely in an automation line.
6. Adopt to Sb regulation

■ Applications

1. Secondary battery
2. Temperature detection for charging
3. Temperature detection for DC fan motor
4. Temperature sensing for appliance
5. Self-standing temperature sensing for fire detector

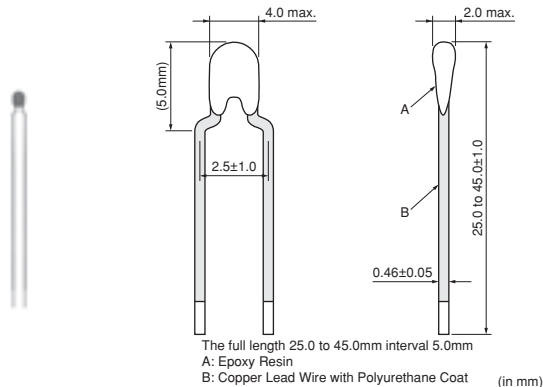

Part Number	Resistance (25°C) (ohm)	B-Constant (25-50°C) (K)	B-Constant (25-80°C) (Reference Value) (K)	B-Constant (25-85°C) (Reference Value) (K)	B-Constant (25-100°C) (Reference Value) (K)	Operating Current for Sensor (25°C) (mA)	Rated Electric Power (25°C) (mW)	Typical Dissipation Constant (25°C) (mW/°C)	Thermal Time Constant (25°C) (s)
NXRT15XM202EA5B□□□	2k ±3%	3500 ±1%	3539	3545	3560	0.36	13	2.6	4
NXRT15XV502FA5B□□□	5k ±1%	3936 ±1%	3972	3977	3989	0.22	13	2.6	4
NXRT15XH103FA5B□□□	10k ±1%	3380 ±1%	3428	3434	3455	0.16	13	2.6	4
NXRT15XV103FA5B□□□	10k ±1%	3936 ±1%	3971	3977	3988	0.16	13	2.6	4
NXRT15WB333JA5B□□□	33k ±5%	4050 ±3%	4101	4108	4131	0.08	13	2.6	4
NXRT15WB473FA5B□□□	47k ±1%	4050 ±1%	4101	4108	4131	0.07	13	2.6	4
NXRT15WF104FA5B□□□	100k ±1%	4250 ±1%	4303	4311	4334	0.05	13	2.6	4

□□□ is filled with Total-length codes. (25 to 45mm interval 5mm, ex. 040=40mm)

Operating Current for Sensor rises Thermistor's temperature by 0.1°C.

Rated Electric Power is necessary electric power that thermistor's temperature rises 5°C by self-heating at 25°C in still air.

Operating Temperature Range: -40°C to +125°C

Temperature Sensor Lead Insulation Type (Radial Type) Specifications and Test Methods

No.	Item	Specifications	Test Methods
1	Resistance to Soldering Heat (Flow)	<ul style="list-style-type: none"> Resistance (R25°C) fluctuation rate: less than ±1%. B-Constant (B25/50°C) fluctuation rate: less than ±1%. 	<p>Both lead wires are dipped into 350±10°C solder for 3.5±0.5 seconds, or 260 ±5°C solder for 10±1 seconds according to Fig-1. (solder <SnAgCu>)</p>  <p style="text-align: center;">Fig-1</p>
2	Solderability (Flow)	<ul style="list-style-type: none"> More than 90% of lead wire surface shall be covered by solder. 	<p>Both lead wires are dipped into flux (25wt% colophony <JIS K 5902> isopropyl alcohol <JIS K 8839>) for 5 to 10 seconds. Then both lead wire are dipped into 245±5°C solder <SnAgCu> for 2±0.5 seconds according to Fig-1.</p>
3	Lead Wire Breaking Strength	<ul style="list-style-type: none"> Resistance (R25°C) fluctuation rate: less than ±1%. B-Constant (B25/50°C) fluctuation rate: less than ±1%. 	<p>One end of a lead wire shall be fixed and 2.5N force for 10 seconds shall be applied to the other lead wire as shown in Fig-2.</p>  <p style="text-align: center;">Fig-2</p>
4	Lead Wire Bending Strength	<ul style="list-style-type: none"> Lead wire does not break. 	<p>One lead wire is held and 2.5N force is applied. Then the body of NTC thermistor is bent by 90° and again bent back to the initial position. This sequence shall be completed twice. See Fig-3.</p>  <p style="text-align: center;">Fig-3</p>
5	Free Fall	<ul style="list-style-type: none"> Resistance (R25°C) fluctuation rate: less than ±1%. 	<p>NTC thermistor shall be dropped without any force onto concrete floor from 1 meter height one time.</p>
6	Vibration	<ul style="list-style-type: none"> B-Constant (B25/50°C) fluctuation rate: less than ±1%. No visible damage at resin part. 	<p>NTC thermistor shall be fixed to the vibration test equipment. Vibration of total 1.5 mm amplitude, frequency sequence of 10Hz - 55Hz - 10Hz in 1 minute, shall be applied for right angled 3 directions for 2 hours duration each.</p>
7	Cold	<ul style="list-style-type: none"> Resistance (R25°C) fluctuation rate: less than ±1%. 	<p>-40 +0/-3°C in air, for 1000 +48/-0 hours without loading.</p>
8	Dry Heat	<ul style="list-style-type: none"> B-Constant (B25/50°C) fluctuation rate: less than ±1%. 	<p>125±2°C in air, for 1000 +48/-0 hours without loading.</p>
9	High Temperature with Continuous Load		<p>85±2°C in air, with 'Operating Current for Sensor' for 1000 +48/-0 hrs.</p>
10	Damp Heat	<ul style="list-style-type: none"> Resistance (R25°C) fluctuation rate: less than ±2%. 	<p>60±2°C, 90 to 95%RH in air, for 1000 +48/-0 hours without loading.</p>
11	Change of Temperature	<ul style="list-style-type: none"> B-Constant (B25/50°C) fluctuation rate: less than ±1%. 	<p>-40°C +0/-3°C, 30 minutes in air +25°C±2°C, 10 to 15 minutes in air +125°C +3/-0°C, 30 minutes in air +25°C +2/-0°C, 10 to 15 minutes in air (1 cycle) Continuous 100 +4/-0 cycles, without loading.</p>
12	Dielectric Breakdown Voltage	<ul style="list-style-type: none"> No damage electrical characteristics on D.C.100V, 1 min. 	<p>2mm length of coating resin from the top of thermistor is to be dipped into beads of lead (Pb), and DC100V 1 minute is applied to circuit between beads of lead (Pb) and lead wire.</p>

Temperature Sensor Thermo String/Lead Type Temperature Characteristics (Center Value)

Part Number	NXFT15XH103	NXFT15XV103	NXFT15WB473	NXFT15WF104
Resistance	10kΩ	10kΩ	47kΩ	100kΩ
B-Constant	3380K	3936K	4050K	4250K
Temp. (°C)	Resistance (kΩ)	Resistance (kΩ)	Resistance (kΩ)	Resistance (kΩ)
-40	197.388	337.503	1690.590	4221.280
-35	149.395	243.332	1215.320	2995.040
-30	114.345	177.496	882.908	2147.000
-25	88.381	130.859	647.911	1554.600
-20	68.915	97.428	480.069	1136.690
-15	54.166	73.230	359.009	839.019
-10	42.889	55.529	270.868	624.987
-5	34.196	42.467	206.113	469.678
0	27.445	32.747	158.126	355.975
5	22.165	25.450	122.267	272.011
10	18.010	19.932	95.256	209.489
15	14.720	15.727	74.754	162.559
20	12.099	12.498	59.075	127.057
25	10.000	10.000	47.000	100.000
30	8.309	8.054	37.636	79.222
35	6.939	6.529	30.326	63.167
40	5.824	5.324	24.583	50.677
45	4.911	4.366	20.043	40.904
50	4.160	3.601	16.433	33.195
55	3.539	2.985	13.545	27.091
60	3.024	2.488	11.223	22.224
65	2.593	2.083	9.345	18.323
70	2.233	1.752	7.818	15.184
75	1.929	1.480	6.571	12.635
80	1.673	1.256	5.548	10.566
85	1.455	1.070	4.704	8.873
90	1.270	0.916	4.004	7.481
95	1.112	0.787	3.422	6.337
100	0.976	0.679	2.936	5.384
105	0.860	0.588	2.528	4.594
110	0.759	0.512	2.184	3.934
115	0.673	0.446	1.893	3.380
120	0.598	0.391	1.646	2.916
125	0.532	0.343	1.436	2.522

Part Number	NXRT15XM202	NXRT15XV502	NXRT15XH103	NXRT15XV103	NXRT15WB333	NXRT15WB473	NXRT15WF104
Resistance	2.0kΩ	5.0kΩ	10kΩ	10kΩ	33kΩ	47kΩ	100kΩ
B-Constant	3500K	3936K	3380K	3936K	4050K	4050K	4250K
Temp. (°C)	Resistance (kΩ)	Resistance (kΩ)	Resistance (kΩ)	Resistance (kΩ)	Resistance (kΩ)	Resistance (kΩ)	Resistance (kΩ)
-40	44.981	168.752	195.652	337.503	1227.263	1747.920	4397.119
-35	33.671	121.666	148.171	243.332	874.449	1245.428	3088.599
-30	25.444	88.748	113.347	177.496	630.851	898.485	2197.225
-25	19.417	65.430	87.559	130.859	460.457	655.802	1581.881
-20	14.955	48.714	68.237	97.428	339.797	483.954	1151.037
-15	11.619	36.615	53.650	73.230	253.363	360.850	846.579
-10	9.097	27.764	42.506	55.529	190.766	271.697	628.988
-5	7.178	21.233	33.892	42.467	144.964	206.463	471.632
0	5.707	16.374	27.219	32.747	111.087	158.214	357.012
5	4.568	12.725	22.021	25.450	85.842	122.259	272.500
10	3.682	9.966	17.926	19.932	66.861	95.227	209.710
15	2.986	7.864	14.674	15.727	52.470	74.730	162.651
20	2.437	6.249	12.081	12.498	41.471	59.065	127.080
25	2.000	5.000	10.000	10.000	33.000	47.000	100.000
30	1.651	4.027	8.315	8.054	26.430	37.643	79.222
35	1.370	3.264	6.948	6.529	21.298	30.334	63.167
40	1.143	2.662	5.834	5.324	17.266	24.591	50.677
45	0.958	2.183	4.917	4.366	14.076	20.048	40.904
50	0.807	1.801	4.161	3.601	11.538	16.433	33.195
55	0.682	1.493	3.535	2.985	9.506	13.539	27.091
60	0.580	1.244	3.014	2.488	7.870	11.209	22.224
65	0.495	1.041	2.586	2.083	6.549	9.328	18.323
70	0.424	0.876	2.228	1.752	5.475	7.798	15.184
75	0.365	0.740	1.925	1.480	4.595	6.544	12.635
80	0.315	0.628	1.669	1.256	3.874	5.518	10.566
85	0.273	0.535	1.452	1.070	3.282	4.674	8.873
90	0.237	0.458	1.268	0.916	2.789	3.972	7.481
95	0.207	0.394	1.110	0.787	2.379	3.388	6.337
100	0.181	0.340	0.974	0.679	2.038	2.902	5.384
105	0.160	0.294	0.858	0.588	1.751	2.494	4.594
110	0.141	0.256	0.758	0.512	1.509	2.150	3.934
115	0.124	0.223	0.672	0.446	1.306	1.860	3.380
120	0.110	0.195	0.596	0.391	1.134	1.615	2.916
125	0.098	0.172	0.531	0.343	0.987	1.406	2.522

Detailed Resistance - Temperature Tables are downloadable from the following URL.
<http://search.murata.co.jp/Ceramy/CatsearchAction.do?sLang=en>

Temperature Sensor Thermo String/Lead Type ⚠Caution/Notice

■ ⚠Caution (Storage and Operating Conditions)

This product is designed for application in an ordinary environment (normal room temperature, humidity and atmospheric pressure).

Do not use under the following conditions because all of these factors can deteriorate the product characteristics or cause failures and burn-out.

1. Corrosive gas or deoxidizing gas

(Chlorine gas, Hydrogen sulfide gas, Ammonia gas, Sulfuric acid gas, Nitric oxide gas, etc.)

2. Volatile or flammable gas

3. Dusty conditions

4. Under vacuum, or under high or low pressure

5. Wet or humid locations

6. Places with salt water, oils, chemical liquids or organic solvents

7. Strong vibrations

8. Other places where similar hazardous conditions exist

■ ⚠Caution (Others)

Be sure to provide an appropriate fail-safe function on your product to prevent secondary damage that may be caused by the abnormal function or the failure of our product.

■ Notice (Storage and Operating Conditions)

To keep the solderability of the product from degrading, the following storage condition is recommended.

1. Storage condition:

Temperature -10 to +40°C

Humidity less than 75%RH (not dewing condition)

2. Storage term:

Use this product within 6 months after delivery by first-in and first-out stocking system.

3. Handling after unpacking:

After unpacking, reseal product promptly or store it in a sealed container with a drying agent.

4. Storage place:

Do not store this product in corrosive gas (Sulfuric acid gas, Chlorine gas, etc.) or in direct sunlight.

■ Notice (Rating)

Use this product within the specified temperature range.

Higher temperature may cause deterioration of the characteristics or the material quality of this product.

■ Notice (Soldering and Mounting) NXF Series

Please note as shown below when you mount this product.

1. Do not melt the solder in the resin head when you solder this product. If you do so, there is a possibility of wire breakage, electric short mode failure and wire coating breakage. If you cut the lead wire of this product less than 20mm from the resin head, the heat of the melted solder at the lead wire edge is propagated easily to the resin head along the lead wire.

2. Do not touch the resin head directly with the soldering iron. It may cause the melting of solder in the resin head.

3. Do not separate the parallel lead wires 10mm or less from the resin.

4. If you mold this product with resin, please evaluate the quality of this product before you use it.

5. Do not bend the lead wire radius 1mm or more.

Continued on the following page. 

Temperature Sensor Thermo String/Lead Type ⚠Caution/Notice

☐ Continued from the preceding page.

■ Notice (Soldering and Mounting) NXR Series

Please note as shown below when you mount this product.

1. Do not melt the solder in the resin head, when you solder this product. If you melt the solder in resin the head, the wire could break and short.

If you cut the lead wire of this product less than 8mm from the resin head, the heat of the melted solder at the lead wire edge is propagated easily to the resin head along the lead wire. Please do not cut this product below 9mm.

2. Do not touch the resin head directly with the solder iron. It may cause the melting of solder in the resin head.
3. If you mold this product with resin, please evaluate the quality of this product before you use it.

■ Notice (Soldering and Mounting) NXR Series (Insulation Type)

Please note as shown below when you mount this product.

1. Do not melt the solder in the resin head when you solder this product. (more than 25mm in full length of the product).

If you melt the solder in the resin head, it has possibility that the wire could break and short.

2. Do not touch the resin head directly with the solder iron. It may cause the melting of solder in the resin head.
3. When additional processing is carried out on this product (such as bonding, resin molding, and resin coating, etc.), please perform an audit of quality level on an automated machine and only use the product after confirming its reliability.

Please talk to us if you have concern matter, like process it under the high temperature and the high pressure.

(For example, exposed to high-temperature and high-pressure environment as mold sealing with injection molding.)

■ Notice (Handling) NXF/NXR Series

1. The ceramic element of this product is fragile, and care must be taken not to load an excessive press-force or not to cause a shock at handling. Such forces may cause cracking or chipping.
2. Do not apply excessive force to the lead. Otherwise, it may cause the junction between lead and element to break or crack. Holding the element by the side lead wire is recommended when lead wire is bent or cut.

■ Notice (Handling) NXR Series (Insulation Type)

1. The ceramic element of this product is fragile, and care must be taken not to load an excessive press-force or not to cause a shock at handling. Such forces may cause cracking or chipping. Especially under high-temperature environment, there is a possibility that epoxy resin will become soft. When you set up the processing environment, please examine the processing method after evaluating the quality of this product.

2. Do not apply excessive force to the lead. Otherwise, it may cause the junction between lead and element to break or crack. Holding the element by the side lead wire is recommended when lead wire is bent or cut. Handle the lead with care; there is a possibility that a crack may go into the polyurethane insulated coat when bending the lead.

Temperature Sensor Thermo String/Lead Type Package

■ Minimum Order Quantity

Bulk		Ammo Pack Taping	
Part Number	Minimum Quantity (pcs.)	Part Number	Minimum Quantity (pcs.)
NXFT	1,000	-	-
NXRT	500	NXRT_3A016	2,500

■ Taping Dimensions (NXRT_3A016 Series)



Item	Code	Dimensions (mm)
Pitch of Component	P	12.7±1.0
Pitch of Sprocket Hole	P0	12.7±0.3
Lead Spacing	F	5.0±1.0
Length from Hole Center to Component Center	P2	6.35±1.3
Length from Hole Center to Lead	P1	3.85±0.7
Body Diameter	D	4.0 max.
Deviation Along Tape, Left or Right	ΔS	0±2.0
Carrier Tape Width	W3	18.0±0.5
Position of Sprocket Hole	W1	9.0±0.5
Lead Distance between Reference and Bottom Planes	H0	16.0±1.0
Height of Component	H3	7.5±1.0
Protrusion Length	l	+0.5 to -1.0
Diameter of Sprocket Hole	øD0	4.0±0.1
Lead Diameter	ød	0.40±0.05
Total Tape Thickness	t1	0.6±0.3
Total Thickness, Tape and Lead Wire	t2	1.6 max.
Deviation Across Tape	Δh1, Δh2	1.0 max.
Portion to Cut in Case of Defect	L3	11.0 ⁺⁰ _{-2.0}
Hold down Tape Width	W0	9.5 min.
Hold down Tape Position	W2	1.5±1.5
Thickness	T	2.0 max.

NTC Thermistors

Inrush Current Suppression Lead Type

This product effectively suppresses surge currents that are generated when switching power regulators are turned on.

■ Features

1. Lead is not contained in the ceramic element, the terminations, the solder for inner connection and the coating resin.
2. Most suitable for power supplies of less than 100W
3. Excellent recovery characteristics due to resin coating with excellent heat characteristics
4. Highly reliable

■ Applications

1. Switching power supplies
2. CRT monitors
3. Color televisions
4. VCR power supplies
5. Other power circuits



Part Number	Resistance (25°C) (ohm)	Permissible Max. Current (25°C) (A)	Permissible Max. Current (55°C) (A)	Thermal Time Constant (25°C) (s)	Thermal Dissipation Constant (25°C) (mW/°C)
NTPAN3R0LDKB0	3.0 ±15%	5.4	4.7	135	26.8
NTPAN4R0LDKB0	4.0 ±15%	4.7	4.1	130	26.8
NTPAN6R0LDKB0	6.0 ±15%	3.9	3.4	130	26.8
NTPAJ4R0LDKB0	4.0 ±15%	4.0	3.5	125	21.8
NTPAJ6R0LDKB0	6.0 ±15%	3.4	2.9	125	21.8
NTPAJ8R0LDKB0	8.0 ±15%	3.0	2.6	130	21.8
NTPAJ100LDKB0	10.0 ±15%	2.6	2.2	130	21.8
NTPAD3R9LDNB0	3.9 ±15%	3.3	2.9	65	18.2
NTPAD5R1LDNB0	5.1 ±15%	3.0	2.6	85	18.8
NTPAD8R0LDNB0	8.0 ±15%	2.7	2.3	65	18.7
NTPAD160LDNB0	16.0 ±15%	2.0	1.7	100	19.1
NTPAA2R2LDNB0	2.2 ±15%	3.7	3.2	70	13.5

Continued on the following page. ↗

☞ Continued from the preceding page.

Part Number	Resistance (25°C) (ohm)	Permissible Max. Current (25°C) (A)	Permissible Max. Current (55°C) (A)	Thermal Time Constant (25°C) (s)	Thermal Dissipation Constant (25°C) (mW/°C)
NTPAA3R9LDNB0	3.9 ±15%	2.7	2.3	70	13.5
NTPAA5R1LDNB0	5.1 ±15%	2.5	2.2	70	13.5
NTPAA8R2LDNB0	8.2 ±15%	2.0	1.7	70	13.5
NTPAA100LDNB0	10.0 ±15%	1.7	1.5	70	13.5
NTPA94R0LBMB0	4.0 ±15%	2.5	2.2	65	11.6
NTPA95R0LBMB0	5.0 ±15%	2.3	2.0	65	11.6
NTPA98R0LBMB0	8.0 ±15%	1.8	1.6	65	11.6
NTPA9100LBMB0	10.0 ±15%	1.7	1.5	65	11.6
NTPA9160LBMB0	16.0 ±15%	1.4	1.2	65	11.6
NTPA74R0LBMB0	4.0 ±15%	2.3	2.0	40	9.4
NTPA75R0LBMB0	5.0 ±15%	1.9	1.6	40	9.4
NTPA78R0LBMB0	8.0 ±15%	1.7	1.5	40	9.5
NTPA7100LBMB0	10.0 ±15%	1.4	1.2	40	9.5
NTPA7160LBMB0	16.0 ±15%	1.2	1.0	40	9.9
NTPA7220LBMB0	22.0 ±15%	1.0	0.88	40	9.1
NTPA64R0LBMB0	4.0 ±15%	2.3	2.0	30	7.5
NTPA64R7LBMB0	4.7 ±15%	2.1	1.9	30	7.5
NTPA68R0LBMB0	8.0 ±15%	1.7	1.5	30	7.5
NTPA55R0LBMB0	5.0 ±15%	1.7	1.5	20	5.6
NTPA5100LBMB0	10.0 ±15%	1.2	1.1	20	5.6

NTPAD/NTPAA/NTPA9/NTPA7 series are also available on tape. The final alphabet of the part number should be "DNB0=>D6A0", "BNB0 =>B1A0".
 Operating Temperature Range: -20°C to +160°C

■ Permissible Electrolytic Capacitor

Part Number	Voltage (AC)					
	100Vrms	120Vrms	132Vrms	220Vrms	240Vrms	264Vrms
NTPAN	8600μF	5972μF	4936μF	1777μF	1493μF	1234μF
NTPAJ	5000μF	3472μF	2870μF	1033μF	868μF	717μF
NTPAD	2700μF	1875μF	1550μF	558μF	469μF	387μF
NTPAA	1400μF	972μF	803μF	289μF	243μF	201μF
NTPA9	800μF	556μF	459μF	165μF	139μF	115μF
NTPA74R0	700μF	486μF	402μF	145μF	122μF	100μF
NTPA75R0						
NTPA78R0	570μF	396μF	327μF	118μF	99μF	82μF
NTPA7100						
NTPA7160	400μF	278μF	230μF	83μF	69μF	57μF
NTPA7220						
NTPA64R0	620μF	431μF	356μF	128μF	108μF	89μF
NTPA64R7						
NTPA68R0	560μF	389μF	321μF	116μF	97μF	80μF
NTPA5	346μF	240μF	198μF	71μF	60μF	50μF

■ Application Circuit



■ Determination of Allowable Current



Current - R Ratio (RT/R25)/Current - Temperature Characteristics (Typical)

■ NTPAN3R0L Type



■ NTPAN4R0L Type



■ NTPAN6R0L Type



■ NTPAJ4R0L Type



■ NTPAJ6R0L Type



■ NTPAJ8R0L Type



8

■ NTPAJ100L Type



■ NTPAD3R9L Type



Continued on the following page. ↗

Current - R Ratio (RT/R25)/Current - Temperature Characteristics (Typical)

↳ Continued from the preceding page.

■ NTPAD5R1L Type



■ NTPAD8R0L Type



■ NTPAD160L Type



■ NTPAA2R2L Type



■ NTPAA3R9L Type



■ NTPAA5R1L Type



■ NTPAA8R2L Type



■ NTPAA100L Type



Continued on the following page. ↗

Current - R Ratio (RT/R25)/Current - Temperature Characteristics (Typical)

Continued from the preceding page.

■ NTPA94R0L Type



■ NTPA95R0L Type

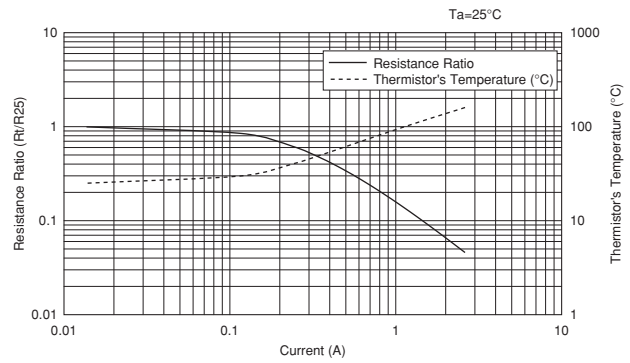

■ NTPA98R0L Type



■ NTPA9100L Type

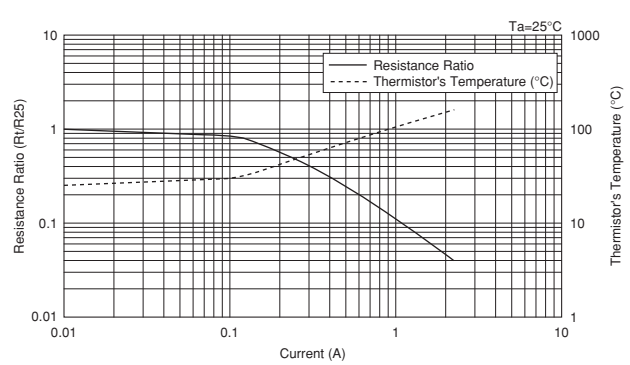

■ NTPA9160L Type



■ NTPA74R0L Type

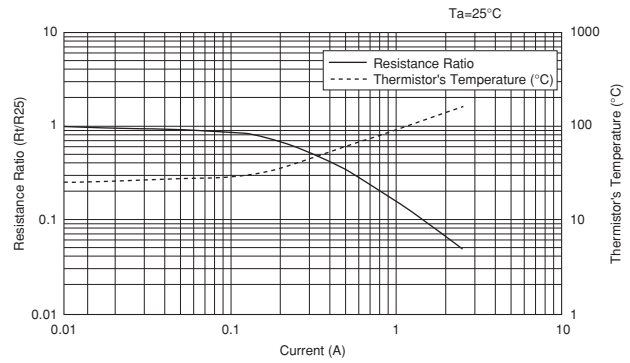

8

■ NTPA75R0L Type



■ NTPA78R0L Type

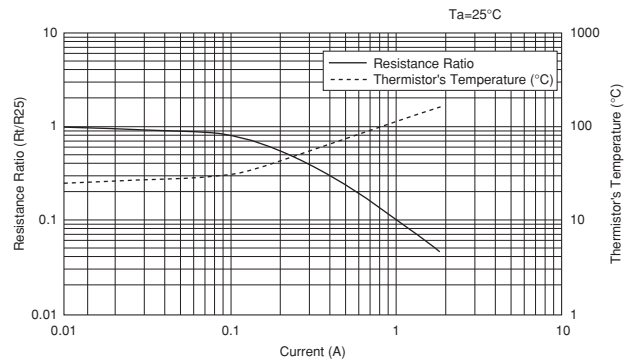

Continued on the following page. ↗

Current - R Ratio (RT/R25)/Current - Temperature Characteristics (Typical)

↳ Continued from the preceding page.

■ NTPA7100L Type



■ NTPA7160L Type



■ NTPA7220L Type



■ NTPA64R0L Type



■ NTPA64R7L Type



■ NTPA68R0L Type



■ NTPA55R0L Type

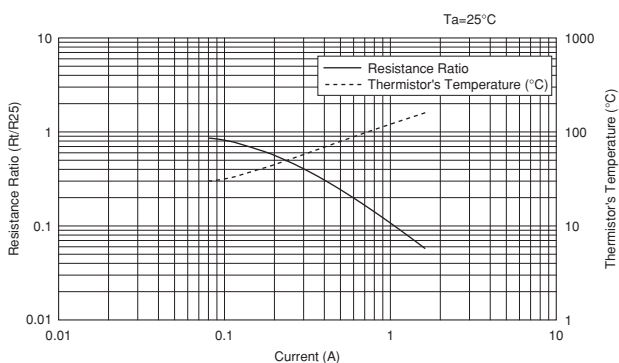

■ NTPA5100L Type

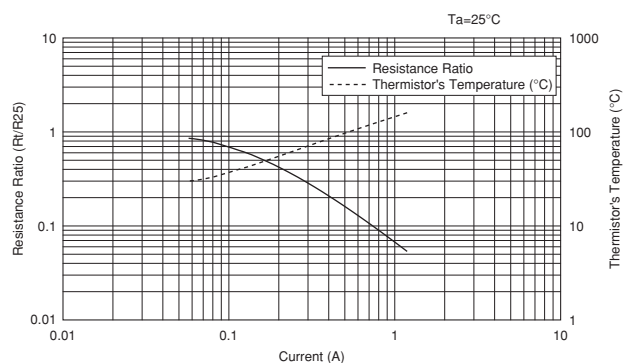

Inrush Current Suppression Lead Type ⚠Caution/Notice

■ ⚠Caution (Storage and Operating Conditions)

1. This product is designed for Switching Power Supplies with smoothing capacitors.
Other applications of this product may result in fire.
2. Use this product within the specified maximum current.
Otherwise it may catch fire in the worst case.
3. Use this product with smoothing capacitors within the specified maximum capacitance value. Otherwise it may catch fire in the worst case.
4. This product is designed for application in an ordinary environment
(normal room temperature, humidity and atmospheric pressure).

Do not use under the following conditions because all these factors can deteriorate the product characteristics cause failure and burn-out.

- (1) Corrosive gas or deoxidizing gas.
(Chlorine gas, Hydrogen sulfide gas, Ammonia gas, Sulfuric acid gas, Nitric oxide gas, etc.)
- (2) Volatile or flammable gas
- (3) Dusty conditions
- (4) Under high or low pressure
- (5) Wet or humid conditions
- (6) Near with salt water, oils, chemical liquids or organic solvents
- (7) Strong vibrations
- (8) Other places where similar hazardous conditions exist.

■ ⚠Caution (Others)

Be sure to provide an appropriate fail-safe function on your product to prevent secondary damage that may be caused by the abnormal function or the failure of our product.

■ Notice (Storage and Operating Conditions)

To keep the solderability of the product from degrading, the following storage condition is recommended.

1. Storage condition:
Temperature -10 to +40°C
Humidity less than 75%RH (not dewing condition)
2. Storage term:
Use this product within 6 months after delivery by first-in and first-out stocking system.

3. Handling after unpacking:
After unpacking, reseal product promptly or store it in a sealed container with a drying agent.
4. Storage place:
Do not store this product in corrosive gas (Sulfuric acid gas, Chlorine gas, etc.) or in direct sunlight.

■ Notice (Rating)

Use this product within the specified temperature range.
Higher temperature may cause deterioration of the characteristics or the material quality of this product.

■ Notice (Soldering and Mounting)

1. Be sure that the preheat-up does not melt the soldering of this product. Excessive heat may cause failure to open, short or insulation break down.
2. Do not touch the body with the soldering iron.
The soldering point should be min. 5mm away from the root of the lead wire.

Inrush Current Suppression Lead Type ⚠Caution/Notice

■ Notice (Handling)

1. When this product is operated, the temperature of some areas may be about 160°C.
Use proper surrounding parts and material that withstand such temperature. If they are inadequate and kept at high temperature for a long time, they may be deteriorated or may produce harmful gas. Such harmful gas may deteriorate the element of this product.
2. This product does not have waterproof construction. Splashed water may cause failure mode such as deterioration of characteristics or current leak. Therefore, do not apply clean by immersing it into water or any solvent.

3. The ceramic element of this product is fragile, and care must be taken not to load an excessive press-force or not to cause a shock at handling. Such forces may cause cracking or chipping to the element.
4. Do not apply excessive force to the lead wire. Otherwise, it may cause the junction between lead wire and element to break or crack, or may crack the element. Therefore, fix the lead wire of the element side when the lead wire is bent or cut.

■ Notice (Others)

1. This product may allow the passing of higher current than its initial value if it receives inrush current again before it cools down enough to recover its original resistance.
Be sure to consider the highest current under actual operating conditions operating temperature.
2. The resin coating of this product does not guarantee insulating. Keep an adequate insulating distance from surrounding parts.

Inrush Current Suppression Lead Type Package

Minimum Order Quantity

Bulk		Ammo Pack Taping	
Part Number	Minimum Quantity (pcs.)	Part Number	Minimum Quantity (pcs.)
NTPAN_DKB0	50	-	-
NTPAJ_DKB0	100	-	-
NTPAD_DNB0	150	NTPAD_D6A0	400
NTPAA_DNB0	300	NTPAA_D6A0	750
NTPA9_BMB0	300	NTPA9_B1A0	1,000
NTPA7_BMB0	500	NTPA7_B1A0	1,000
NTPA6_BMB0	500	NTPA6_B1A0	1,000
NTPA5_BMB0	500	NTPA5_B1A0	1,500

Taping Dimensions (NTPAD/A_D6A0 Series)



Item	Code	Dimensions (mm)
Pitch of Component	P	30.0
Pitch of Sprocket Hole	P ₀	15.0±0.3
Lead Spacing	F	7.5±0.5
Length from Hole Center to Component Center	P ₂	7.5±1.5
Length from Hole Center to Lead	P ₁	3.75±1.0
Body Diameter	D	(refer to the table below)
Body Thickness	T	(refer to the table below)
Deviation Along Tape, Left or Right	ΔS	±2.0
Carrier Tape Width	W	18.0±0.5
Position of Sprocket Hole	W ₁	9.0±0.5
Lead Distance between Reference and Bottom Plane	H ₀	16.0±0.5
Height of Component	H ₂	10.0 max.
Protrusion Length	l	+0.5 to -6.0
Diameter of Sprocket Hole	D ₀	4.0±0.1
Lead Diameter	d	0.8±0.05
Total Tape Thickness	t ₁	0.6±0.3
Total Thickness, Tape and Lead Wire	t ₂	2.0 max.
Deviation Across Tape	Δh ₁ , Δh ₂	2.0 max.
Portion to Cut in Case of Defect	L	11.0 ⁺⁰ _{-2.0}
Hold down Tape Width	W ₀	11.5 min.
Hold down Tape Position	W ₂	4.0 max.
Coating Extension on Lead	e	to line A

Type	D (mm)	T (mm)
NTPAD	16.0 max.	5.5 max.
NTPAA	12.0 max.	5.0 max.

Continued on the following page.

Inrush Current Suppression Lead Type Package

Continued from the preceding page.

Taping Dimensions (NTPA9/7/6/5_B1A0 Series)



Item	Code	Dimensions (mm)
Pitch of Component	P	12.7
Pitch of Sprocket Hole	P ₀	12.7±0.3
Lead Spacing	F	5.0 ^{+0.8} _{-0.3}
Length from Hole Center to Component Center	P ₂	6.35±1.3
Length from Hole Center to Lead	P ₁	3.85±0.8
Body Diameter	D	(refer to the table below)
Body Thickness	T	5.0 max.
Deviation Along Tape, Left or Right	ΔS	±1.5
Carrier Tape Width	W	18.0±0.5
Position of Sprocket Hole	W ₁	9.0 ^{+0.5} _{-0.75}
Lead Distance between Reference and Bottom Planes	H ₀	16.0±1.0
Height of Component	H ₂	6.0 max.
Protrusion Length	l	+0.5 to -4.0
Diameter of Sprocket Hole	D ₀	4.0±0.3
Lead Diameter	d	0.6±0.05
Total Tape Thickness	t ₁	0.6±0.3
Total Thickness, Tape and Lead Wire	t ₂	2.0 max.
Deviation Across Tape	Δh ₁ , Δh ₂	1.5 max.
Portion to Cut in Case of Defect	L	11.0 ⁺⁰ _{-2.0}
Hold down Tape Width	W ₀	11.0 min.
Hold down Tape Position	W ₂	4.0 max.
Coating Extension on Lead	e	to line A

Type	D (mm)
NTPA9	11.0 max.
NTPA7	9.0 max.
NTPA6	7.5 max.
NTPA5	6.0 max.

Global Locations

For details please visit www.murata.com



⚠ Note

1 Export Control

For customers outside Japan:

No Murata products should be used or sold, through any channels, for use in the design, development, production, utilization, maintenance or operation of, or otherwise contribution to (1) any weapons (Weapons of Mass Destruction [nuclear, chemical or biological weapons or missiles] or conventional weapons) or (2) goods or systems specially designed or intended for military end-use or utilization by military end-users.

For customers in Japan:

For products which are controlled items subject to the "Foreign Exchange and Foreign Trade Law" of Japan, the export license specified by the law is required for export.

2 Please contact our sales representatives or product engineers before using the products in this catalog for the applications listed below, which require especially high reliability for the prevention of defects which might directly damage a third party's life, body or property, or when one of our products is intended for use in applications other than those specified in this catalog.

- ① Aircraft equipment
- ② Aerospace equipment
- ③ Undersea equipment
- ④ Power plant equipment
- ⑤ Medical equipment
- ⑥ Transportation equipment (vehicles, trains, ships, etc.)
- ⑦ Traffic signal equipment
- ⑧ Disaster prevention / crime prevention equipment
- ⑨ Data-processing equipment
- ⑩ Application of similar complexity and/or reliability requirements to the applications listed above

3 Product specifications in this catalog are as of December 2014. They are subject to change or our products in it may be discontinued without advance notice. Please check with our sales representatives or product engineers before ordering. If there are any questions, please contact our sales representatives or product engineers.

4 Please read rating and ⚠CAUTION (for storage, operating, rating, soldering, mounting and handling) in this catalog to prevent smoking and/or burning, etc.

5 This catalog has only typical specifications. Therefore, please approve our product specifications or transact the approval sheet for product specifications before ordering.

6 Please note that unless otherwise specified, we shall assume no responsibility whatsoever for any conflict or dispute that may occur in connection with the effect of our and/or a third party's intellectual property rights and other related rights in consideration of your use of our products and/or information described or contained in our catalogs. In this connection, no representation shall be made to the effect that any third parties are authorized to use the rights mentioned above under licenses without our consent.

7 No ozone depleting substances (ODS) under the Montreal Protocol are used in our manufacturing process.

Murata Manufacturing Co., Ltd.

www.murata.com

muRata
INNOVATOR IN ELECTRONICS

Компания «Океан Электроники» предлагает заключение долгосрочных отношений при поставках импортных электронных компонентов на взаимовыгодных условиях!

Наши преимущества:

- Поставка оригинальных импортных электронных компонентов напрямую с производств Америки, Европы и Азии, а так же с крупнейших складов мира;
- Широкая линейка поставок активных и пассивных импортных электронных компонентов (более 30 млн. наименований);
- Поставка сложных, дефицитных, либо снятых с производства позиций;
- Оперативные сроки поставки под заказ (от 5 рабочих дней);
- Экспресс доставка в любую точку России;
- Помощь Конструкторского Отдела и консультации квалифицированных инженеров;
- Техническая поддержка проекта, помощь в подборе аналогов, поставка прототипов;
- Поставка электронных компонентов под контролем ВП;
- Система менеджмента качества сертифицирована по Международному стандарту ISO 9001;
- При необходимости вся продукция военного и аэрокосмического назначения проходит испытания и сертификацию в лаборатории (по согласованию с заказчиком);
- Поставка специализированных компонентов военного и аэрокосмического уровня качества (Xilinx, Altera, Analog Devices, Intersil, Interpoint, Microsemi, Actel, Aeroflex, Peregrine, VPT, Syfer, Eurofarad, Texas Instruments, MS Kennedy, Miteq, Cobham, E2V, MA-COM, Hittite, Mini-Circuits, General Dynamics и др.);

Компания «Океан Электроники» является официальным дистрибьютором и эксклюзивным представителем в России одного из крупнейших производителей разъемов военного и аэрокосмического назначения «JONHON», а так же официальным дистрибьютором и эксклюзивным представителем в России производителя высокотехнологичных и надежных решений для передачи СВЧ сигналов «FORSTAR».



JONHON

«JONHON» (основан в 1970 г.)

Разъемы специального, военного и аэрокосмического назначения:

(Применяются в военной, авиационной, аэрокосмической, морской, железнодорожной, горно- и нефтедобывающей отраслях промышленности)

«FORSTAR» (основан в 1998 г.)

ВЧ соединители, коаксиальные кабели,
кабельные сборки и микроволновые компоненты:

(Применяются в телекоммуникациях гражданского и специального назначения, в средствах связи, РЛС, а так же военной, авиационной и аэрокосмической отраслях промышленности).



Телефон: 8 (812) 309-75-97 (многоканальный)

Факс: 8 (812) 320-03-32

Электронная почта: ocean@oceanchips.ru

Web: <http://oceanchips.ru/>

Адрес: 198099, г. Санкт-Петербург, ул. Калинина, д. 2, корп. 4, лит. А