

Using the TPS43060 Boost Evaluation Module (EVM)

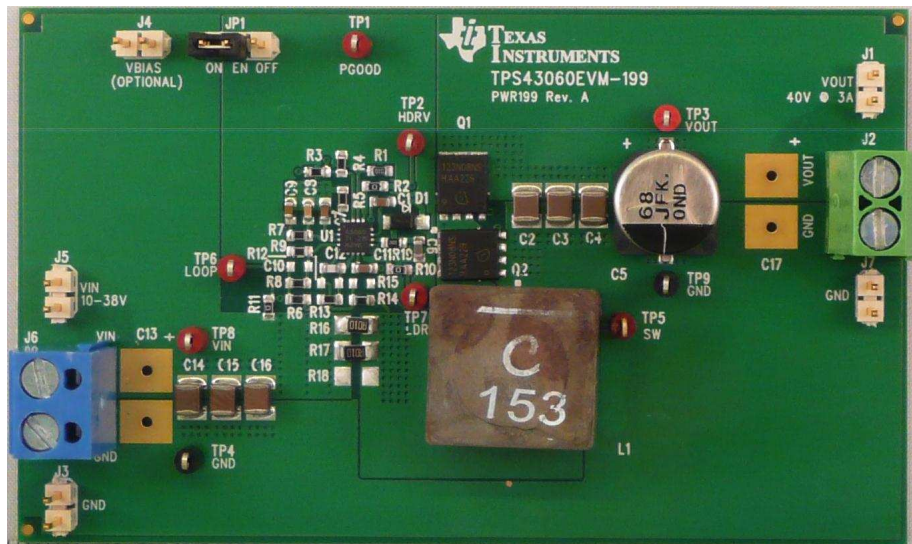

This user's guide contains information for the TPS43060EVM-199 evaluation module (PWR199) including the performance specifications, schematic, and the bill of materials.

Contents

1	Introduction	3
2	Test Setup and Results	7
3	Bill of Materials	13
4	Board Layout.....	14

List of Figures

1	TPS43060EVM-199 Schematic.....	5
2	Efficiency Versus Load Current	8
3	Light Load Efficiency Versus Load Current	8
4	Regulation Versus Output Current	8
5	Regulation Versus Input Voltage	8
6	Load Transient Response	9
7	Loop Response	9
8	Output Voltage Ripple CCM	10
9	Output Voltage Ripple DCM	10
10	Output Voltage Ripple Pulse Skip Mode	10
11	Input Voltage Ripple CCM	11
12	Input Voltage Ripple DCM	11
13	Start Up Relative to V_{IN}	11
14	Start Up Relative to EN.....	11
15	Shutdown Relative to V_{IN}	12
16	Shutdown Relative to EN.....	12

17	Gate-Drive Signals	12
18	TPS43060EVM-199 Top Assembly and Silkscreen	14
19	TPS43060EVM-199 Top-Side Layout	15
20	TPS43060EVM-199 Layer 2 Layout	15
21	TPS43060EVM-199 Layer 3 Layout	16
22	TPS43060EVM-199 Bottom-Side Layout	16

List of Tables

1	Input Voltage and Output Current Summary	3
2	TPS43060EVM-199 Performance Specification Summary.....	4
3	EVM Connectors and Test points	7
4	TPS43060EVM-199 Bill of Materials.....	13

1 Introduction

This user's guide contains background information for the TPS43060 as well as support documentation for the TPS43060EVM-199 evaluation module (PWR199). Also included are the performance specifications, schematic, and the bill of materials for the EVM.

1.1 Background

The TPS43060 is a DC-DC synchronous boost controller designed for a maximum output voltage of 58 V from an input voltage source of 4.5 V to 38 V. It has a 7.5-V gate-drive supply optimized for use with standard threshold MOSFETs. Rated input voltage and output current range for the evaluation module are given in [Table 1](#). This evaluation module is designed to demonstrate the high efficiency and high power possible when designing with the TPS43060 controller. The switching frequency is externally set at a nominal 300 kHz. The gate-drive circuitry for the external high-side and low-side FET is incorporated inside the TPS43060 package. PWR199 uses the Infineon BSC123N08NS3G for both the high-side and low-side MOSFETs. External inductor DCR or resistor current sensing allows for an adjustable cycle-by-cycle current limit. The compensation components are external to the integrated circuit (IC), and an external resistor divider allows for an adjustable output voltage. Additionally, the TPS43060 provides an adjustable undervoltage lockout with hysteresis through an external resistor divider, adjustable slow-start time with an external capacitor and a power good output voltage indicator. The absolute maximum input voltage for the PWR199 is 38 V.

Table 1. Input Voltage and Output Current Summary

EVM	Input Voltage Range	Output Current Range
TPS43060EVM-199	$V_{IN} = 10 \text{ V to } 38 \text{ V}$	$I_{OUT} = 0 \text{ A to } 3 \text{ A}$

1.2 Performance Specification Summary

A summary of the EVM performance specifications is provided in [Table 2](#). Specifications are given for an input voltage of $V_{IN} = 24\text{ V}$ and an output voltage of 40 V , unless otherwise specified. This EVM is designed and tested for $V_{IN} = 10\text{ V}$ to 38 V . The ambient temperature is 25°C for all measurements, unless otherwise noted.

Table 2. TPS43060EVM-199 Performance Specification Summary

Specification	Test Conditions	MIN	TYP	MAX	Unit	
V_{IN} voltage range		10	24	38	V	
Output voltage set point			40		V	
Output current range	$V_{IN} = 15\text{ V}$ to 38 V	0		3	A	
Output current range	$V_{IN} = 10\text{ V}$	0		2	A	
Line regulation	$V_{IN} = 10\text{ V}$ to 35 V , $I_{OUT} = 2\text{ A}$		$\pm 0.1\%$			
Load regulation	$I_{OUT} = 0.001\text{ A}$ to 3 A		$\pm 0.1\%$			
Load transient response	$I_{OUT} = 0.75\text{ A}$ to 2.25 A	Voltage change	-700		mV	
		Recovery time	1		ms	
	$I_{OUT} = 2.25\text{ A}$ to 0.75 A	Voltage change		600		mV
		Recovery time		1		ms
Loop bandwidth	$I_{OUT} = 3\text{ A}$		4.7		kHz	
Phase margin	$I_{OUT} = 3\text{ A}$		64		°	
Input voltage ripple	$I_{OUT} = 3\text{ A}$		100		mVpp	
Output voltage ripple	$I_{OUT} = 3\text{ A}$		350		mVpp	
Output rise time			25		ms	
Operating frequency			300		kHz	
Peak efficiency	$I_{OUT} = 3\text{ A}$		97.7%			
DCM threshold			660		mA	
Pulse skipping threshold			3.5		mA	
No load input current			1.3		mA	
UVLO start threshold			9.66		V	
UVLO stop threshold			7.92		V	

1.3 Schematic

Figure 1 is the schematic for the EVM.

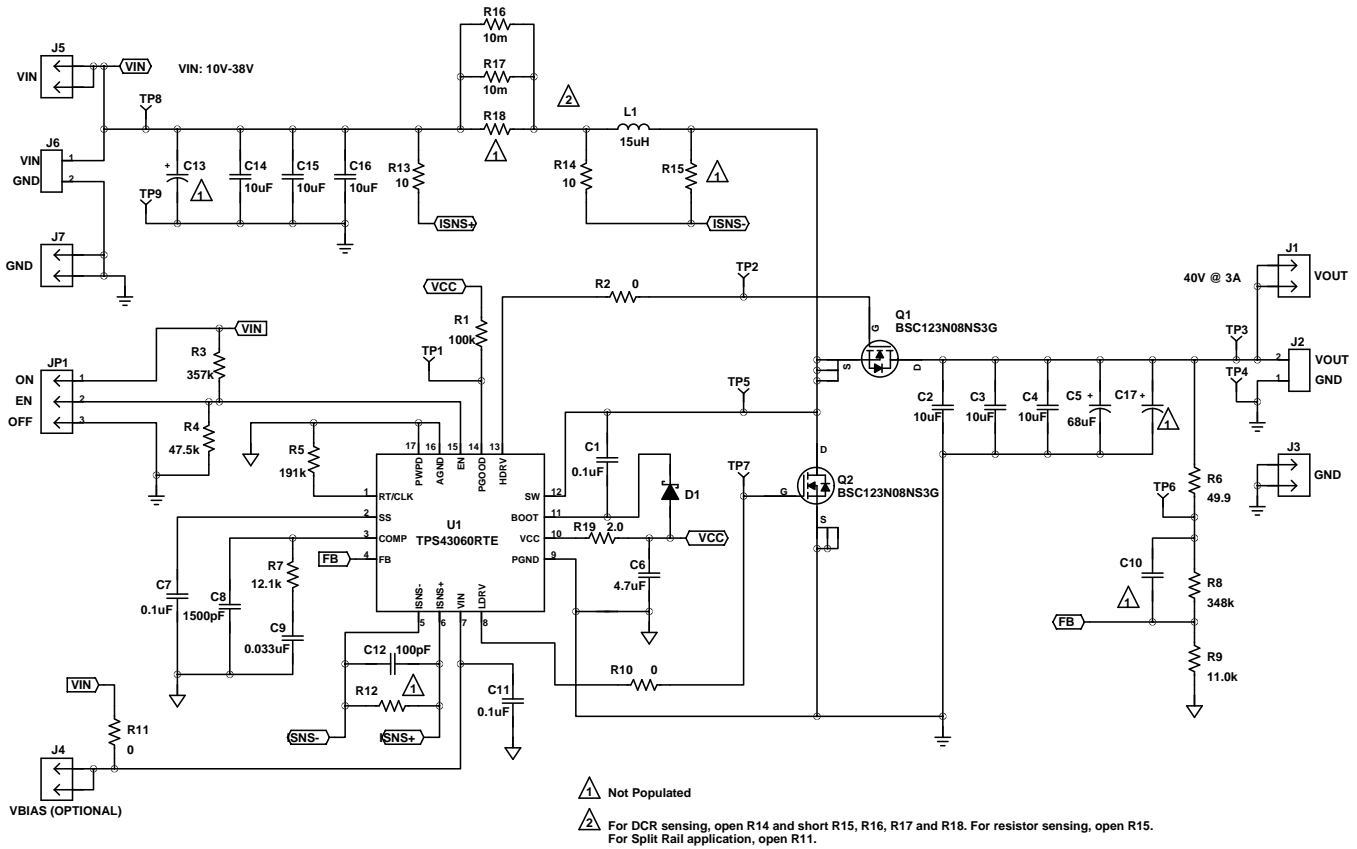

Figure 1. TPS43060EVM-199 Schematic

1.4 Modifications

The EVM is designed to provide access to the features of the TPS43060. Some modifications can be made to this module. For further details please see the product data sheet.

1.4.1 Output Voltage Set Point

To change the output voltage of the EVM, it is necessary to change the value of resistor R8. The value of R8 for a specific output voltage can be calculated using Equation 1, where R_{HS} is R8, R_{LS} is R9 and V_{FB} is 1.22 V. It is recommended to use a value of R9 near 10 kΩ.

$$R_{HS} = R_{LS} \times \frac{V_{OUT} - V_{FB}}{V_{FB}} \tag{1}$$

Note: V_{IN} must be in a range so the minimum on-time is greater than the typical 100 ns and the minimum off-time is greater than the largest of typical 250 ns and 5% of the switching period.

1.4.2 Current Sensing

The default configuration of the EVM is for resistor current sensing. R13 and R14 are populated with R15 open. When adjusting the input voltage, output voltage or desired maximum output voltage, the current sense resistors R16 and R17 may need to be adjusted. The peak inductor current should first be calculated with Equation 2. Equation 3 is then used to calculate the required current sense resistor where $V_{CS\text{typ}}$ is the current sense threshold. $V_{CS\text{typ}}$ should be determined from the TPS43060 data sheet with the maximum duty cycle in the application. Ensure the current sense resistor is rated for the expected power dissipation. For inductor DCR current sensing, R14 should be left open while R15, R16, R17 and R18 are shorted.

$$I_{L\text{peak}} = \frac{I_{\text{OUT}}}{1 - \frac{V_{\text{OUT}} - V_{\text{IN min}}}{V_{\text{OUT}}}} + \frac{V_{\text{IN min}} \times \frac{V_{\text{OUT}} - V_{\text{IN min}}}{V_{\text{OUT}}}}{2 \times L \times f_{\text{SW}}} \quad (2)$$

$$R_{\text{CS}} = \frac{V_{\text{CS typ}}}{1.2 \times I_{L\text{peak}}} \quad (3)$$

1.4.3 Slow-Start Time

Adjust the slow-start time by changing the value of C7. Equation 4 can be used to calculate the required capacitance based on a desired slow-start time, t_{SS} . I_{SS} is the charging current of 5- μA typical and V_{REF} is the internal reference voltage of 1.22 V. The EVM is set for a slow-start time of 25 ms using $C7 = 0.1 \mu\text{F}$.

$$C_{\text{SS}} = \frac{t_{\text{SS}} \times I_{\text{SS}}}{V_{\text{REF}}} \quad (4)$$

1.4.4 Adjustable UVLO

The undervoltage lockout (UVLO) can be adjusted externally using R3 and R4. The EVM is set for a start voltage of 9.66 V and stop voltage of 7.92 V, using $R3 = 357 \text{ k}\Omega$ and $R4 = 47.5 \text{ k}\Omega$. Use Equation 5 and Equation 6 to calculate the required resistor values for R3 and R4, respectively, for different start and stop voltages. The typical values of the constants in the two equations are as follows: $V_{\text{EN_DIS}} = 1.14 \text{ V}$, $V_{\text{EN_ON}} = 1.21 \text{ V}$, $I_{\text{EN_pup}} = 1.8 \mu\text{A}$, and $I_{\text{EN_hys}} = 3.2 \mu\text{A}$.

$$R_{\text{UVLO_H}} = \frac{V_{\text{START}} \times \left(\frac{V_{\text{EN_DIS}}}{V_{\text{EN_ON}}} \right) - V_{\text{STOP}}}{I_{\text{EN_pup}} \times \left(1 - \frac{V_{\text{EN_DIS}}}{V_{\text{EN_ON}}} \right) + I_{\text{EN_hys}}} \quad (5)$$

$$R_{\text{UVLO_L}} = \frac{R_{\text{UVLO_H}} \times V_{\text{EN_DIS}}}{V_{\text{STOP}} - V_{\text{EN_DIS}} + R_{\text{UVLO_H}} \times (I_{\text{EN_pup}} + I_{\text{EN_hys}})} \quad (6)$$

1.4.5 Input Voltage Rails

The EVM is designed to accommodate different input voltage levels for the power stage and control logic. In the default configuration, the VIN inputs connected with R11 populated with a 0- Ω resistor. The input voltage is supplied to J6. If desired, the two input voltage rails may be separated by unpopulating R11. The control logic input voltage can be supplied to J4 and the power stage input voltage to J6.

1.4.6 Further Modification

Changing the input and output of conditions of the EVM will impact the design. It may also be necessary to modify the inductor, output capacitor and compensation components for the desired performance in the application. Please see the data sheet or the excel design spreadsheet located in the product folder for details.

2 Test Setup and Results

This section describes how to properly connect, set up, and use the EVM. The section also includes test results typical for the EVM covering efficiency, output voltage regulation, load transients, loop response, output ripple, input ripple, start up and shutdown.

2.1 Input/Output Connections

This EVM includes I/O connectors and test points as shown in [Table 3](#). A power supply capable of supplying at least 12 A must be connected to J6 through a pair of 20-AWG wires. The load must be connected to J2 through a pair of 20-AWG wires. The maximum load-current capability must be 3 A. Wire lengths must be minimized to reduce losses in the wires. If any modification is done to the EVM design, an input supply and load rated for the new design are required. Test point TP8 provides a connection to monitor the V_{IN} input voltages with TP9 providing a convenient ground reference. TP3 is used to monitor the output voltage with TP4 as the ground reference.

Table 3. EVM Connectors and Test points

Reference Designator	Function
J1	2-pin header for V_{OUT} voltage connections
J2	V_{OUT} , 40 V at 3-A maximum
J3	2-pin header for GND connections
J4	2-pin header for optional V_{BIAS} input voltage connections (see Section 1.4.5)
J5	2-pin header for V_{IN} input voltage connections
J6	V_{IN} (see Table 1 for V_{IN} range)
J7	2-pin header for GND connections
JP1	3-pin header for EN jumper. Install jumper from pins 1-2 to enable or pins 2-3 to disable.
TP1	PGOOD test point for power good output voltage indicator
TP2	HDRV test point for high-side gate-drive voltage
TP3	V_{OUT} test point at V_{OUT} connector
TP4	GND test point at V_{OUT} connector
TP5	SW test point for switch node voltage
TP6	Test point between voltage divider network and output used for loop response measurements
TP7	LDRV test point for low-side gate-drive voltage
TP8	V_{IN} test point at V_{IN} connector
TP9	GND test point at V_{IN} connector

2.2 Efficiency

With the nominal V_{IN} of 24 V, the efficiency of this EVM peaks at a load current of about 3 A, and then decreases as the load current increases towards maximum load. Figure 2 shows the efficiency for the EVM up to current limit with 1-V input and up to a 5-A load with 24-V and 38-V input. Figure 3 shows the light load efficiency using a semi-log scale. Measurements are taken at ambient temperature of 25°C. The efficiency may be lower at higher ambient temperatures due to temperature variation in the drain-to-source resistance of the selected external MOSFETs.

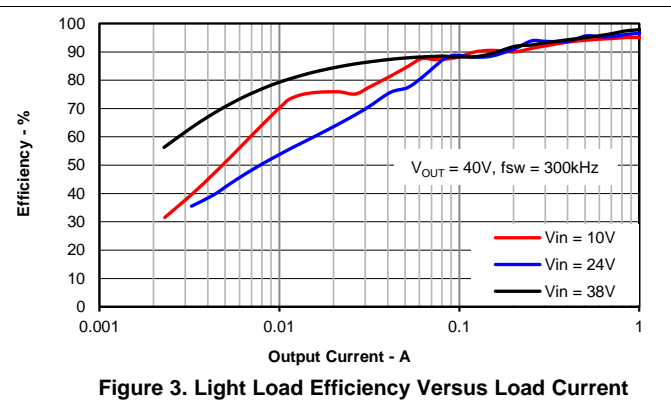
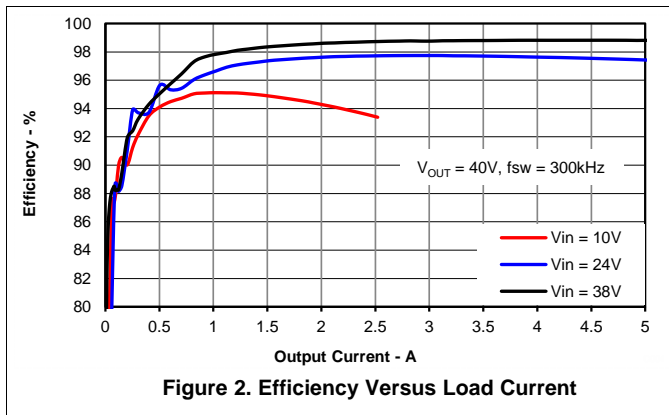

2.3 Output Voltage Regulation

The load regulation for the EVM is shown in Figure 4. The line regulation for the EVM is shown in Figure 5. Measurements are given for an ambient temperature of 25°C.

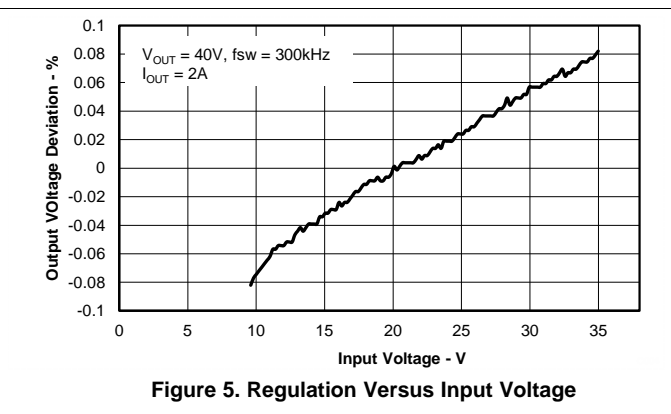
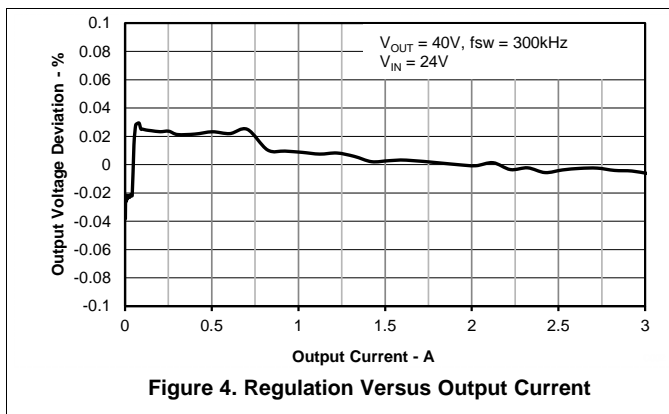

2.4 Load Transients and Loop Response

The EVM response to load transients is shown in Figure 6. The current step is from 25% to 75% of maximum rated load at nominal 24-V input. Total peak-to-peak voltage variation is as shown, including ripple and noise on the output. The EVM loop-response characteristics are shown in Figure 7. Gain and phase plots are shown for nominal V_{IN} voltage of 24 V. Load current for the measurement is 3 A.

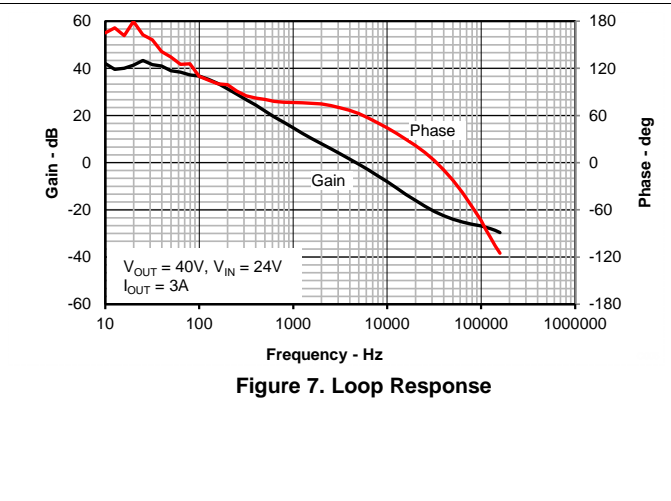
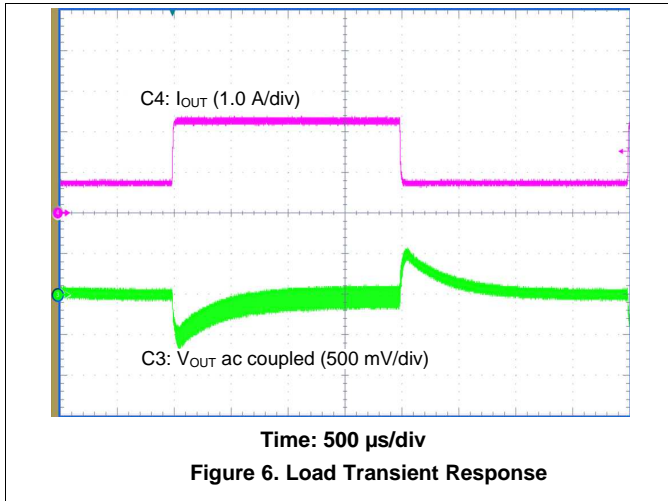

2.5 Output Voltage Ripple

The EVM continuous conduction mode (CCM) output voltage ripple is shown in Figure 8. The output current is the rated full load of 3 A and nominal V_{IN} of 24 V. The voltage ripple is measured directly across the output capacitors with a short ground lead. The discontinuous conduction mode (DCM) output voltage ripple is shown in Figure 9. The output current is 0.3 A and nominal V_{IN} of 24 V. The pulse skip mode output voltage ripple is shown in Figure 10. There is no external load on the output and nominal V_{IN} of 24 V.

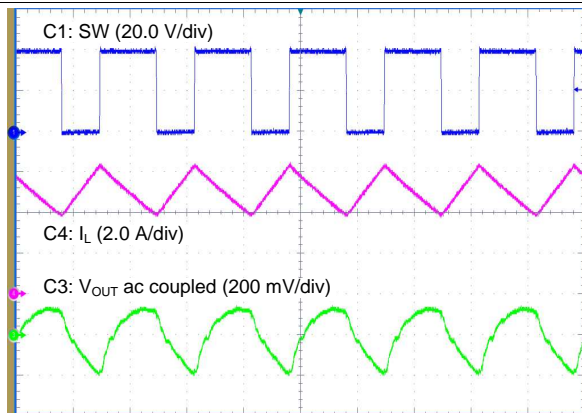

Time: 2.0 μ s/div
Figure 8. Output Voltage Ripple CCM

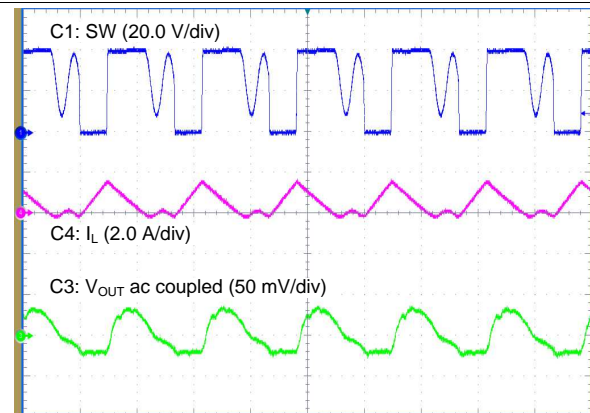

Time: 2.0 μ s/div
Figure 9. Output Voltage Ripple DCM

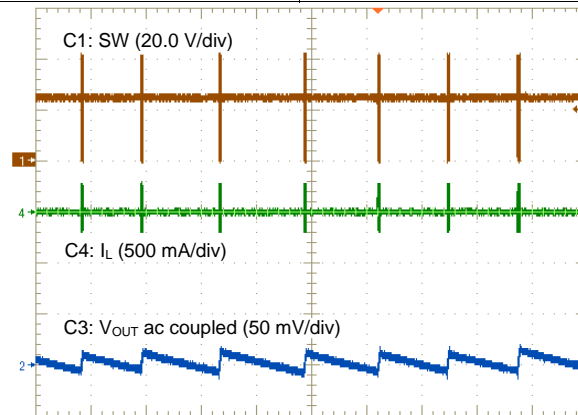

Time: 10.0 ms/div
Figure 10. Output Voltage Ripple Pulse Skip Mode

2.6 Input Voltage Ripple

The EVM CCM input voltage ripple is shown in Figure 11. The output current is the rated full load of 3 A and nominal V_{IN} of 24 V. The voltage ripple is measured directly across the input capacitors. The DCM input voltage ripple is shown in Figure 12. The output current is 0.3 A and nominal V_{IN} of 24 V.

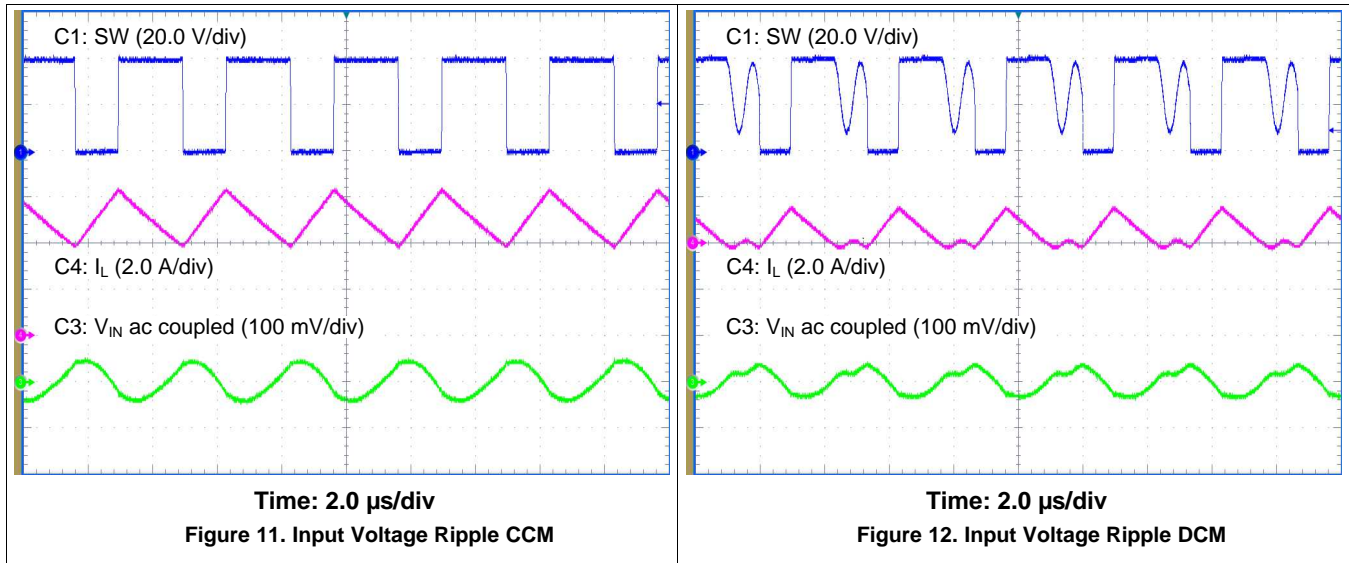

2.7 Start Up

The start up waveforms are shown in Figure 13 and Figure 14. The input voltage for these plots is the nominal 24 V and the output has a 2.5-A resistive load. In Figure 13 the input voltage supply is turned on and V_{IN} begins rising. Both the V_{CC} and V_{OUT} rail initially rise with V_{IN} . When the input reaches the undervoltage lockout threshold set by the external resistor divider, the device can begin switching and the output ramps up to the set value of 40 V with the slow-start voltage. PGOOD goes high when V_{OUT} is in regulation.

In Figure 14 the input voltage is applied with EN held low. The output voltage is a diode drop below the input voltage and V_{CC} is disabled. When EN is released, the start up sequence begins with V_{CC} coming into regulation and the output ramps up to the set value of 40 V. PGOOD goes high when V_{OUT} is in regulation.

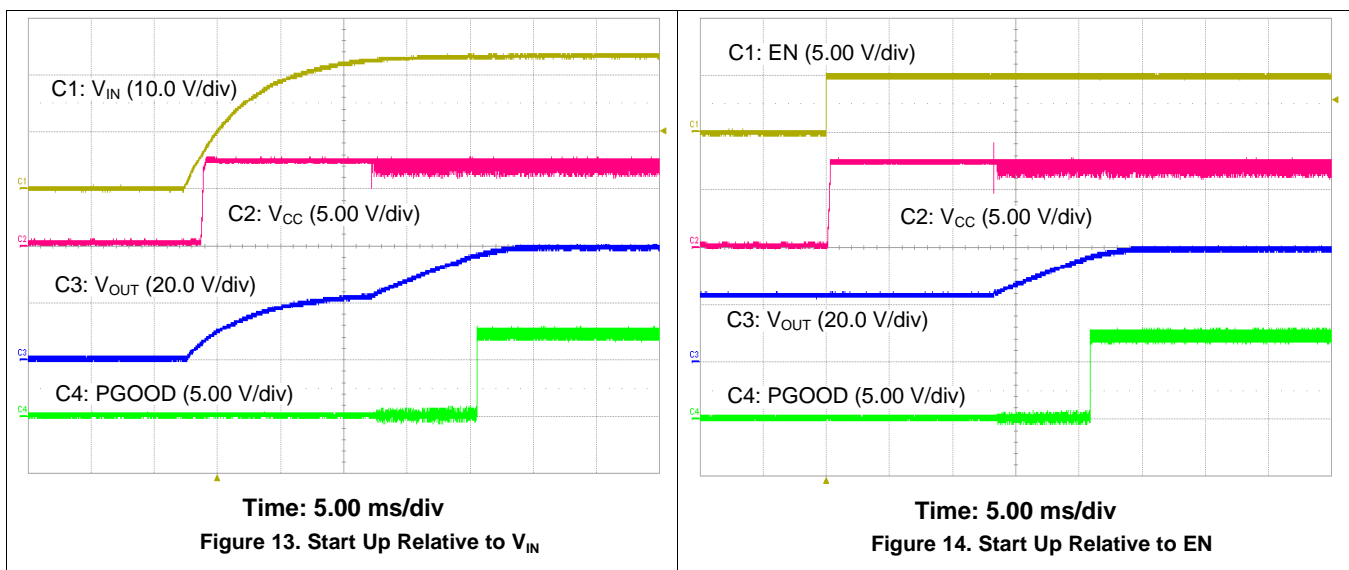

2.8 Shutdown

The shutdown waveforms are shown in [Figure 15](#) and [Figure 16](#). In [Figure 15](#) the input voltage is removed, and when the input falls below the undervoltage lockout threshold set by the EN resistor divider, the TPS43060 shuts down, PGOOD is pulled low and the output falls to ground. The output has a 2.5-A resistive load.

In [Figure 16](#) the input voltage is held at 24 V with no load and EN is shorted to ground. When EN is grounded, the TPS43060 is disabled, PGOOD is pulled low and the output voltage discharges to V_{IN} .

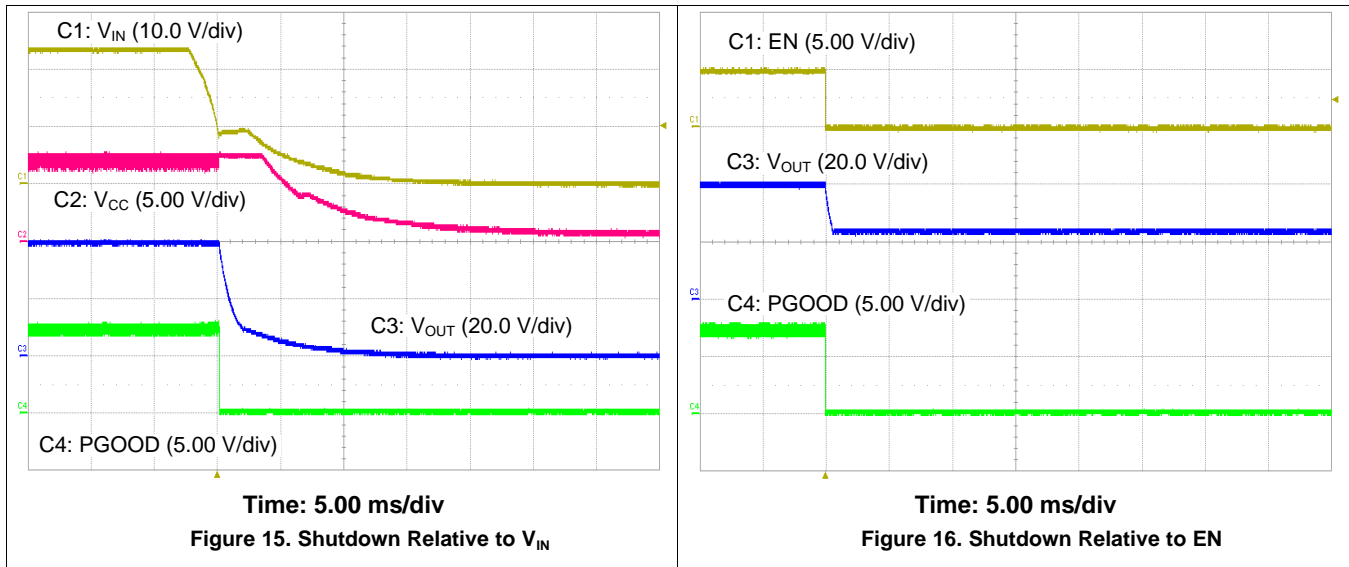

2.9 Gate-Drive Signals

In [Figure 17](#) the gate-drive signals for the high-side and low-side FETs can be seen with the switching node. The input voltage is 24 V and the output has a 3-A load.

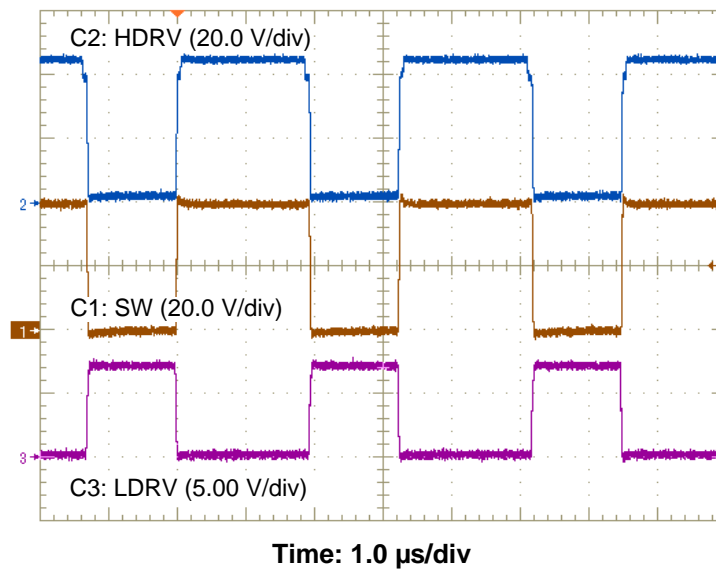

Figure 17. Gate-Drive Signals

3 Bill of Materials

Table 4 presents the bill of materials for the EVM.

Table 4. TPS43060EVM-199 Bill of Materials

COUNT	RefDes	Value	Description	Size	Part Number	MFR
1	C5	68 μ F	Capacitor, Aluminum, 63V, 20%	0.406 x 0.406 inch	EEVFK1J680P	Panasonic
1	C6	4.7 μ F	Capacitor, Ceramic, 16V, X5R, 10%	0603	STD	STD
1	C8	1200pF	Capacitor, Ceramic, 10V, X5R, 10%	0603	STD	STD
1	C9	0.022 μ F	Capacitor, Ceramic, 10V, X5R, 10%	0603	STD	STD
0	C10	Open	Capacitor, Ceramic, 10V, X7R, 10%	0603	STD	STD
1	C12	100pF	Capacitor, Ceramic, 50V, X7R, 20%	0603	STD	STD
3	C1 C7 C11	0.1 μ F	Capacitor, Ceramic, 50V, X7R, 10%	0603	STD	STD
5	C2-4 C14-16	10 μ F	Capacitor, Ceramic, 50V, X7R, 10%	1210	STD	STD
0	C13 C17	Open	Capacitor	Multi sizes	Engineering Only	STD
1	D1	MBR1H100SFT3G	Diode, Schottky Power Rectifier, 1A, 100V	SOD-123LF	MBR1H100SFT3G	On Semi
5	J1 J3-5 J7	PEC02SAAN	Header, Male 2-pin, 100mil spacing	0.100 inch x 2	PEC02SAAN	Sullins
2	J2 J6	ED120/2DS	Terminal Block, 2-pin, 15-A, 5.1mm	0.40 x 0.35 inch	ED120/2DS	OST
1	JP1	PEC03SAAN	Header, Male 3-pin, 100mil spacing	0.100 inch x 3	PEC03SAAN	Sullins
1	L1	15 μ H	Inductor, Shielded Power, 14A, 9m Ω	15.2x16.2 mm	XAL1510-153 alt:74435571500	Coilcraft alt:WE
2	Q1 Q2	BSC123N08NS3G	MOSFET, Nch, 80V, 55A, 12.3m Ω	TDSON-8	BSC123N08NS3G	Infineon
1	R1	100k	Resistor, Chip, 1/16W, 1%	0603	STD	STD
1	R3	357k	Resistor, Chip, 1/16W, 1%	0603	STD	STD
1	R4	47.5k	Resistor, Chip, 1/16W, 1%	0603	STD	STD
1	R5	191k	Resistor, Chip, 1/16W, 1%	0603	STD	STD
1	R6	49.9	Resistor, Chip, 1/16W, 1%	0603	STD	STD
1	R7	15.4k	Resistor, Chip, 1/16W, 1%	0603	STD	STD
1	R8	348k	Resistor, Chip, 1/16W, 1%	0603	STD	STD
1	R9	11.0k	Resistor, Chip, 1/16W, 1%	0603	STD	STD
0	R18	Open	Resistor, Chip, 1W, 1%	1206	STD	STD
0	R12 R15	Open	Resistor, Chip, 1/16W, 1%	0603	STD	STD
2	R13-14	10	Resistor, Chip, 1/16W, 1%	0603	STD	STD
2	R16-17	10m	Resistor, Chip, 1W, 1%	1206	STD	STD
3	R2 R10-11	0	Resistor, Chip, 1/16W, 1%	0603	STD	STD
1	SH1		Short jumper, 100mil	0.100 inch	929950-00	3M
2	TP4 TP9	5001	Test Point, Black, Thru Hole Color Keyed	0.100 x 0.100 inch	5001	Keystone
7	TP1-3 TP5-8	5000	Test Point, Red, Thru Hole Color Keyed	0.100 x 0.100 inch	5000	Keystone
1	U1	TPS43060RTE	IC, Wide VIN Current Mode Synchronous Boost Controller	VQFN	TPS43060RTE	TI
1	--		PCB, 3.5 in x 2.1 in x 0.062 in		PWR199	Any
Notes:	1. These assemblies are ESD sensitive, ESD precautions shall be observed.					
	2. These assemblies must be clean and free from flux and all contaminants.					
	Use of no clean flux is not acceptable.					
	3. These assemblies must comply with workmanship standards IPC-A-610 Class 2.					
	4. Ref designators marked with an asterisk (***) cannot be substituted.					
	All other components can be substituted with equivalent MFG's components.					

4 Board Layout

This section provides a description of the EVM, board layout, and layer illustrations.

4.1 Layout

The board layout for the EVM is shown in [Figure 18](#) through [Figure 22](#). This design has 4 layers of 2-oz copper.

The top layer contains the main power traces for V_{IN} , V_{OUT} , and SW. Also on the top layer are all other components to allow the user to easily view, probe, and evaluate the TPS43060 control IC. The remaining area is filled with ground. The remaining three layers have additional copper for VIN, VOUT, AGND, and PGND connected with multiple vias. Additional copper is also connected to the sense resistor to aid with thermal dissipation. The second internal layer and bottom layer contain signal routes. Four vias directly under the TPS43060 device provide a thermal path from the top-side ground plane to the bottom-side and internal AGND plane. Lastly, the layout guidelines should be followed for Q1 and Q2. Vias are placed near both FETs to aid with thermal dissipation.

All noise-sensitive analog circuitry are placed as close as possible to the IC. The voltage divider network ties to the output voltage at the point of regulation on the bottom layer, near the output capacitors. Q1 and Q2 are placed as close as possible to the IC to keep the gate-drive traces as short as possible. The output capacitors are placed next to Q1 and Q2 to limit the length of the high frequency switching current path. The SW copper is kept as small as possible to limit radiated noise from the high-frequency switching voltage node. The power pad is connected to the AGND pin and all noise-sensitive circuitry must use this as the ground return path. The ground return for the power components are connected to the PGND pin. The AGND and PGND are connected at one point near the PGND pin. The bypass capacitors for VIN and VCC are placed next to their respective pins. The filter capacitor between ISNS+ and ISNS- is located next to the pins to help filter out switching noise. An additional input bulk capacitor may be required (C13) depending on the connection to the EVM from the input supply. See the product datasheet for all layout recommendations.

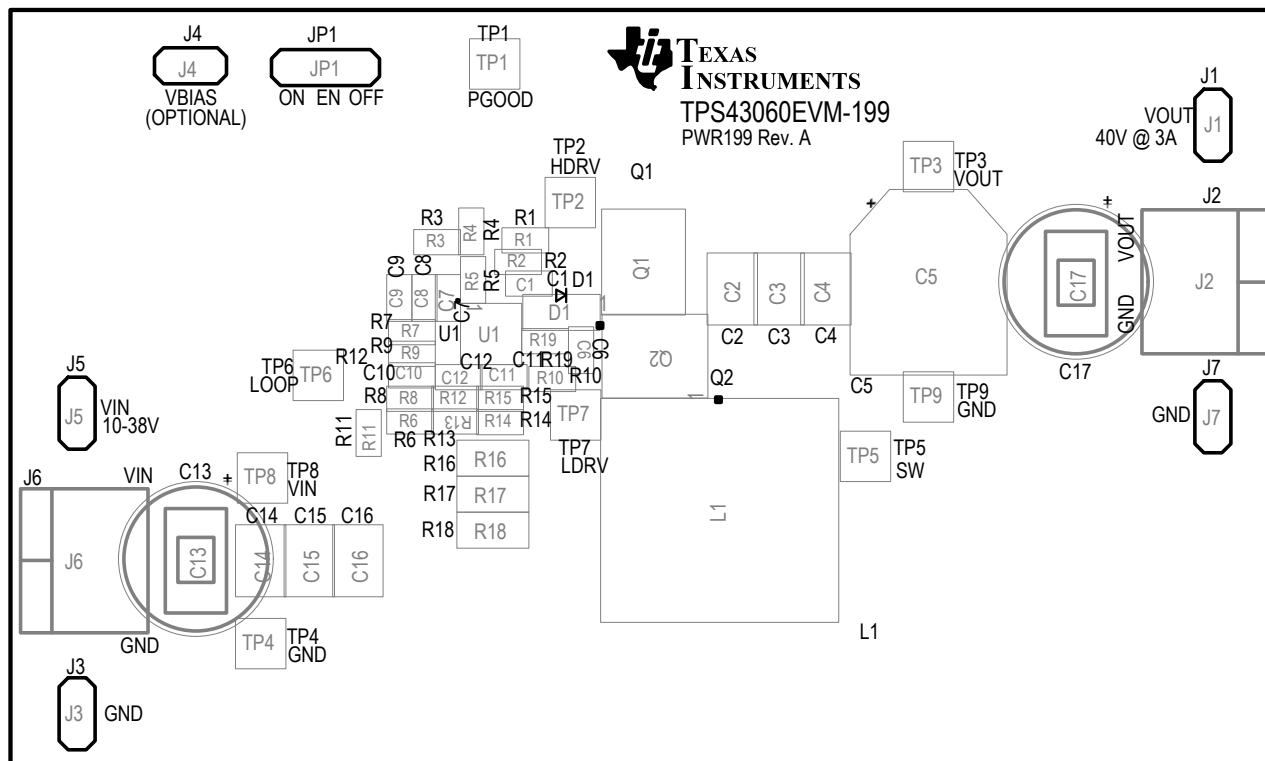

Figure 18. TPS43060EVM-199 Top Assembly and Silkscreen

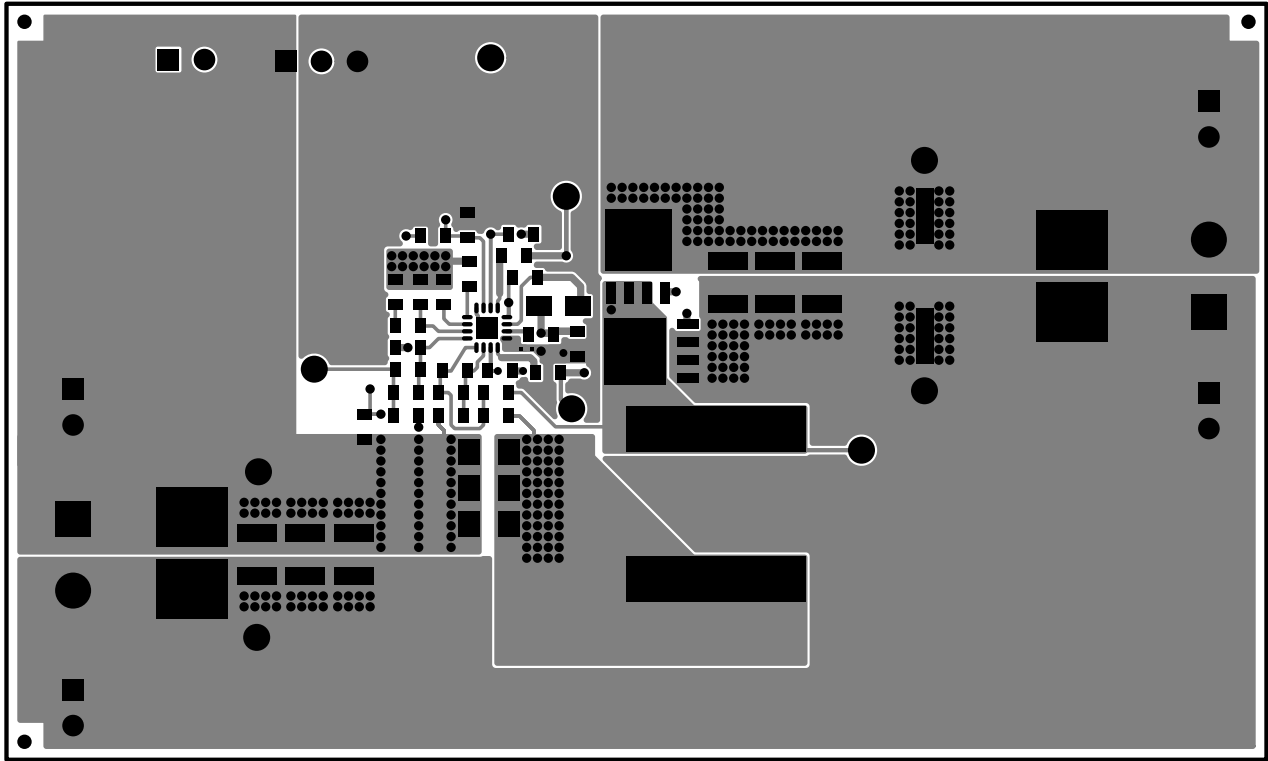

Figure 19. TPS43060EVM-199 Top-Side Layout

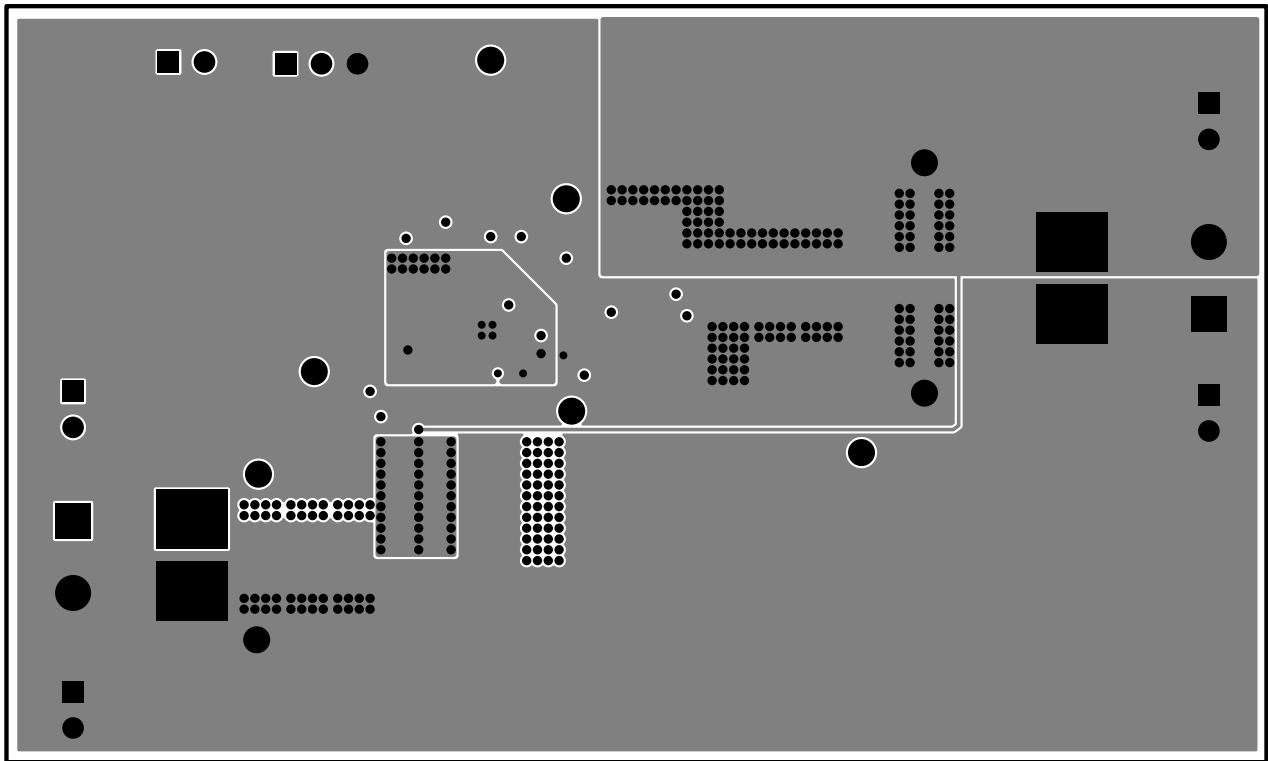

Figure 20. TPS43060EVM-199 Layer 2 Layout

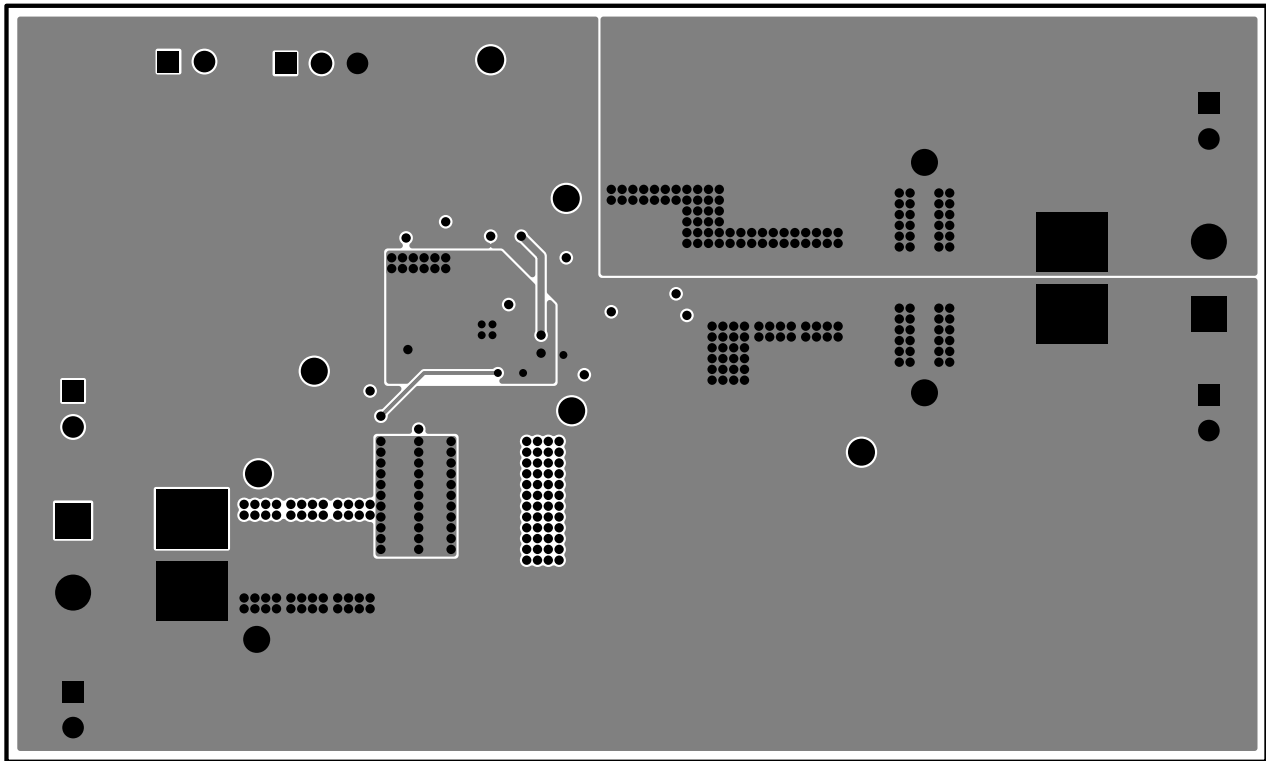

Figure 21. TPS43060EVM-199 Layer 3 Layout

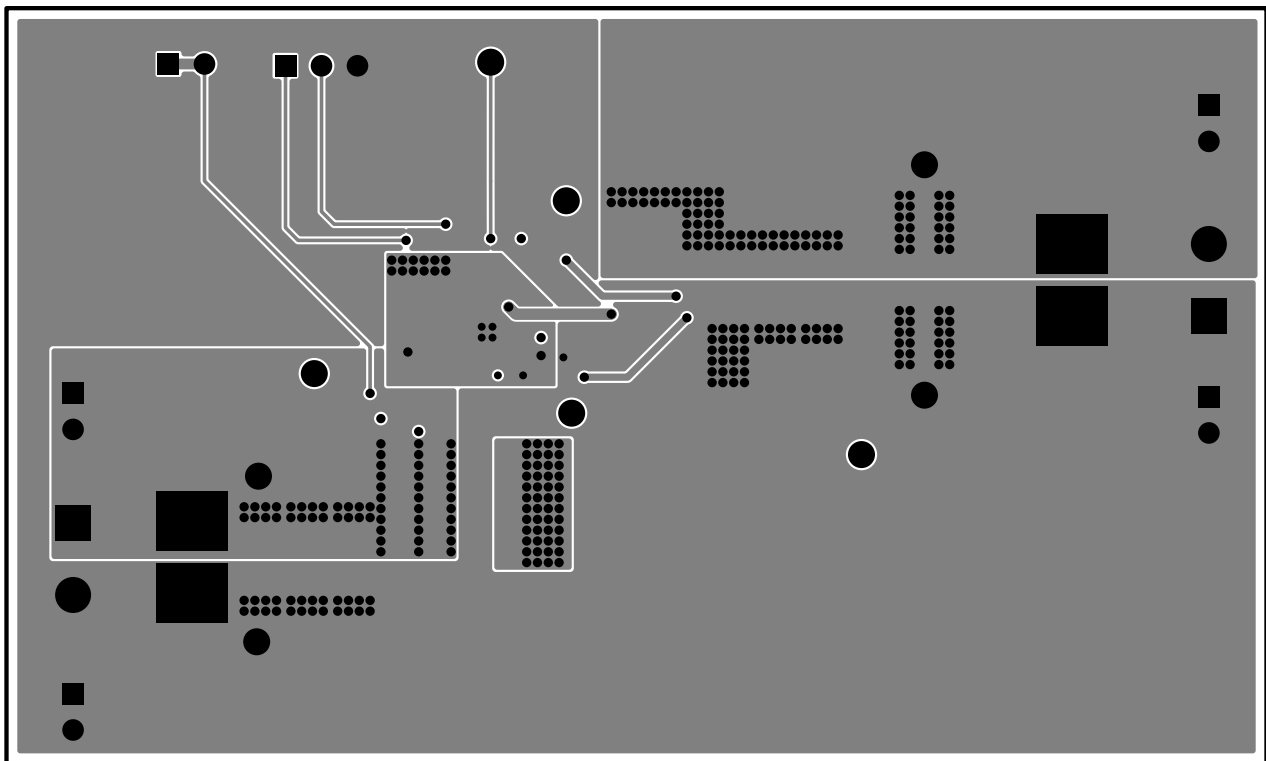

Figure 22. TPS43060EVM-199 Bottom-Side Layout

4.2 Estimated Circuit Area

The estimated printed-circuit-board area by outlining the components and the routing between them is 1.86 in² (1202 mm²). This area does not include test points or connectors. Also note, this design uses 0603 components for easy modifications and places all components on one layer so the area can be reduced.

Revision History

Changes from Original (January 2013) to A Revision	Page
• Changed Table 4 , L1 Part Number From: XAL1510-103 To: XAL1510-153.....	13

NOTE: Page numbers for previous revisions may differ from page numbers in the current version.

ADDITIONAL TERMS AND CONDITIONS, WARNINGS, RESTRICTIONS, AND DISCLAIMERS FOR EVALUATION MODULES

Texas Instruments Incorporated (TI) markets, sells, and loans all evaluation boards, kits, and/or modules (EVMs) pursuant to, and user expressly acknowledges, represents, and agrees, and takes sole responsibility and risk with respect to, the following:

1. User agrees and acknowledges that EVMs are intended to be handled and used for feasibility evaluation only in laboratory and/or development environments. Notwithstanding the foregoing, in certain instances, TI makes certain EVMs available to users that do not handle and use EVMs solely for feasibility evaluation only in laboratory and/or development environments, but may use EVMs in a hobbyist environment. All EVMs made available to hobbyist users are FCC certified, as applicable. Hobbyist users acknowledge, agree, and shall comply with all applicable terms, conditions, warnings, and restrictions in this document and are subject to the disclaimer and indemnity provisions included in this document.
2. Unless otherwise indicated, EVMs are not finished products and not intended for consumer use. EVMs are intended solely for use by technically qualified electronics experts who are familiar with the dangers and application risks associated with handling electrical mechanical components, systems, and subsystems.
3. User agrees that EVMs shall not be used as, or incorporated into, all or any part of a finished product.
4. User agrees and acknowledges that certain EVMs may not be designed or manufactured by TI.
5. User must read the user's guide and all other documentation accompanying EVMs, including without limitation any warning or restriction notices, prior to handling and/or using EVMs. Such notices contain important safety information related to, for example, temperatures and voltages. For additional information on TI's environmental and/or safety programs, please visit www.ti.com/esh or contact TI.
6. User assumes all responsibility, obligation, and any corresponding liability for proper and safe handling and use of EVMs.
7. Should any EVM not meet the specifications indicated in the user's guide or other documentation accompanying such EVM, the EVM may be returned to TI within 30 days from the date of delivery for a full refund. THE FOREGOING LIMITED WARRANTY IS THE EXCLUSIVE WARRANTY MADE BY TI TO USER AND IS IN LIEU OF ALL OTHER WARRANTIES, EXPRESSED, IMPLIED, OR STATUTORY, INCLUDING ANY WARRANTY OF MERCHANTABILITY OR FITNESS FOR ANY PARTICULAR PURPOSE. TI SHALL NOT BE LIABLE TO USER FOR ANY INDIRECT, SPECIAL, INCIDENTAL, OR CONSEQUENTIAL DAMAGES RELATED TO THE HANDLING OR USE OF ANY EVM.
8. No license is granted under any patent right or other intellectual property right of TI covering or relating to any machine, process, or combination in which EVMs might be or are used. TI currently deals with a variety of customers, and therefore TI's arrangement with the user is not exclusive. TI assumes no liability for applications assistance, customer product design, software performance, or infringement of patents or services with respect to the handling or use of EVMs.
9. User assumes sole responsibility to determine whether EVMs may be subject to any applicable federal, state, or local laws and regulatory requirements (including but not limited to U.S. Food and Drug Administration regulations, if applicable) related to its handling and use of EVMs and, if applicable, compliance in all respects with such laws and regulations.
10. User has sole responsibility to ensure the safety of any activities to be conducted by it and its employees, affiliates, contractors or designees, with respect to handling and using EVMs. Further, user is responsible to ensure that any interfaces (electronic and/or mechanical) between EVMs and any human body are designed with suitable isolation and means to safely limit accessible leakage currents to minimize the risk of electrical shock hazard.
11. User shall employ reasonable safeguards to ensure that user's use of EVMs will not result in any property damage, injury or death, even if EVMs should fail to perform as described or expected.
12. User shall be solely responsible for proper disposal and recycling of EVMs consistent with all applicable federal, state, and local requirements.

Certain Instructions. User shall operate EVMs within TI's recommended specifications and environmental considerations per the user's guide, accompanying documentation, and any other applicable requirements. Exceeding the specified ratings (including but not limited to input and output voltage, current, power, and environmental ranges) for EVMs may cause property damage, personal injury or death. If there are questions concerning these ratings, user should contact a TI field representative prior to connecting interface electronics including input power and intended loads. Any loads applied outside of the specified output range may result in unintended and/or inaccurate operation and/or possible permanent damage to the EVM and/or interface electronics. Please consult the applicable EVM user's guide prior to connecting any load to the EVM output. If there is uncertainty as to the load specification, please contact a TI field representative. During normal operation, some circuit components may have case temperatures greater than 60°C as long as the input and output are maintained at a normal ambient operating temperature. These components include but are not limited to linear regulators, switching transistors, pass transistors, and current sense resistors which can be identified using EVMs' schematics located in the applicable EVM user's guide. When placing measurement probes near EVMs during normal operation, please be aware that EVMs may become very warm. As with all electronic evaluation tools, only qualified personnel knowledgeable in electronic measurement and diagnostics normally found in development environments should use EVMs.

Agreement to Defend, Indemnify and Hold Harmless. User agrees to defend, indemnify, and hold TI, its directors, officers, employees, agents, representatives, affiliates, licensors and their representatives harmless from and against any and all claims, damages, losses, expenses, costs and liabilities (collectively, "Claims") arising out of, or in connection with, any handling and/or use of EVMs. User's indemnity shall apply whether Claims arise under law of tort or contract or any other legal theory, and even if EVMs fail to perform as described or expected.

Safety-Critical or Life-Critical Applications. If user intends to use EVMs in evaluations of safety critical applications (such as life support), and a failure of a TI product considered for purchase by user for use in user's product would reasonably be expected to cause severe personal injury or death such as devices which are classified as FDA Class III or similar classification, then user must specifically notify TI of such intent and enter into a separate Assurance and Indemnity Agreement.

RADIO FREQUENCY REGULATORY COMPLIANCE INFORMATION FOR EVALUATION MODULES

Texas Instruments Incorporated (TI) evaluation boards, kits, and/or modules (EVMs) and/or accompanying hardware that is marketed, sold, or loaned to users may or may not be subject to radio frequency regulations in specific countries.

General Statement for EVMs Not Including a Radio

For EVMs not including a radio and not subject to the U.S. Federal Communications Commission (FCC) or Industry Canada (IC) regulations, TI intends EVMs to be used only for engineering development, demonstration, or evaluation purposes. EVMs are not finished products typically fit for general consumer use. EVMs may nonetheless generate, use, or radiate radio frequency energy, but have not been tested for compliance with the limits of computing devices pursuant to part 15 of FCC or the ICES-003 rules. Operation of such EVMs may cause interference with radio communications, in which case the user at his own expense will be required to take whatever measures may be required to correct this interference.

General Statement for EVMs including a radio

User Power/Frequency Use Obligations: For EVMs including a radio, the radio included in such EVMs is intended for development and/or professional use only in legally allocated frequency and power limits. Any use of radio frequencies and/or power availability in such EVMs and their development application(s) must comply with local laws governing radio spectrum allocation and power limits for such EVMs. It is the user's sole responsibility to only operate this radio in legally acceptable frequency space and within legally mandated power limitations. Any exceptions to this are strictly prohibited and unauthorized by TI unless user has obtained appropriate experimental and/or development licenses from local regulatory authorities, which is the sole responsibility of the user, including its acceptable authorization.

U.S. Federal Communications Commission Compliance

For EVMs Annotated as FCC – FEDERAL COMMUNICATIONS COMMISSION Part 15 Compliant

Caution

This device complies with part 15 of the FCC Rules. Operation is subject to the following two conditions: (1) This device may not cause harmful interference, and (2) this device must accept any interference received, including interference that may cause undesired operation. Changes or modifications could void the user's authority to operate the equipment.

FCC Interference Statement for Class A EVM devices

This equipment has been tested and found to comply with the limits for a Class A digital device, pursuant to part 15 of the FCC Rules. These limits are designed to provide reasonable protection against harmful interference when the equipment is operated in a commercial environment. This equipment generates, uses, and can radiate radio frequency energy and, if not installed and used in accordance with the instruction manual, may cause harmful interference to radio communications. Operation of this equipment in a residential area is likely to cause harmful interference in which case the user will be required to correct the interference at its own expense.

FCC Interference Statement for Class B EVM devices

This equipment has been tested and found to comply with the limits for a Class B digital device, pursuant to part 15 of the FCC Rules. These limits are designed to provide reasonable protection against harmful interference in a residential installation. This equipment generates, uses and can radiate radio frequency energy and, if not installed and used in accordance with the instructions, may cause harmful interference to radio communications. However, there is no guarantee that interference will not occur in a particular installation. If this equipment does cause harmful interference to radio or television reception, which can be determined by turning the equipment off and on, the user is encouraged to try to correct the interference by one or more of the following measures:

- Reorient or relocate the receiving antenna.
- Increase the separation between the equipment and receiver.
- Connect the equipment into an outlet on a circuit different from that to which the receiver is connected.
- Consult the dealer or an experienced radio/TV technician for help.

Industry Canada Compliance (English)

For EVMs Annotated as IC – INDUSTRY CANADA Compliant:

This Class A or B digital apparatus complies with Canadian ICES-003.

Changes or modifications not expressly approved by the party responsible for compliance could void the user's authority to operate the equipment.

Concerning EVMs Including Radio Transmitters

This device complies with Industry Canada licence-exempt RSS standard(s). Operation is subject to the following two conditions: (1) this device may not cause interference, and (2) this device must accept any interference, including interference that may cause undesired operation of the device.

Concerning EVMs Including Detachable Antennas

Under Industry Canada regulations, this radio transmitter may only operate using an antenna of a type and maximum (or lesser) gain approved for the transmitter by Industry Canada. To reduce potential radio interference to other users, the antenna type and its gain should be so chosen that the equivalent isotropically radiated power (e.i.r.p.) is not more than that necessary for successful communication.

This radio transmitter has been approved by Industry Canada to operate with the antenna types listed in the user guide with the maximum permissible gain and required antenna impedance for each antenna type indicated. Antenna types not included in this list, having a gain greater than the maximum gain indicated for that type, are strictly prohibited for use with this device.

Canada Industry Canada Compliance (French)

Cet appareil numérique de la classe A ou B est conforme à la norme NMB-003 du Canada

Les changements ou les modifications pas expressément approuvés par la partie responsable de la conformité ont pu vider l'autorité de l'utilisateur pour actionner l'équipement.

Concernant les EVMs avec appareils radio

Le présent appareil est conforme aux CNR d'Industrie Canada applicables aux appareils radio exempts de licence. L'exploitation est autorisée aux deux conditions suivantes : (1) l'appareil ne doit pas produire de brouillage, et (2) l'utilisateur de l'appareil doit accepter tout brouillage radioélectrique subi, même si le brouillage est susceptible d'en compromettre le fonctionnement.

Concernant les EVMs avec antennes détachables

Conformément à la réglementation d'Industrie Canada, le présent émetteur radio peut fonctionner avec une antenne d'un type et d'un gain maximal (ou inférieur) approuvé pour l'émetteur par Industrie Canada. Dans le but de réduire les risques de brouillage radioélectrique à l'intention des autres utilisateurs, il faut choisir le type d'antenne et son gain de sorte que la puissance isotrope rayonnée équivalente (p.i.r.e.) ne dépasse pas l'intensité nécessaire à l'établissement d'une communication satisfaisante.

Le présent émetteur radio a été approuvé par Industrie Canada pour fonctionner avec les types d'antenne énumérés dans le manuel d'usage et ayant un gain admissible maximal et l'impédance requise pour chaque type d'antenne. Les types d'antenne non inclus dans cette liste, ou dont le gain est supérieur au gain maximal indiqué, sont strictement interdits pour l'exploitation de l'émetteur.

Mailing Address: Texas Instruments, Post Office Box 655303, Dallas, Texas 75265
Copyright © 2014, Texas Instruments Incorporated

Important Notice for Users of EVMs Considered “Radio Frequency Products” in Japan

EVMs entering Japan are NOT certified by TI as conforming to Technical Regulations of Radio Law of Japan.

If user uses EVMs in Japan, user is required by Radio Law of Japan to follow the instructions below with respect to EVMs:

1. Use EVMs in a shielded room or any other test facility as defined in the notification #173 issued by Ministry of Internal Affairs and Communications on March 28, 2006, based on Sub-section 1.1 of Article 6 of the Ministry's Rule for Enforcement of Radio Law of Japan,
2. Use EVMs only after user obtains the license of Test Radio Station as provided in Radio Law of Japan with respect to EVMs, or
3. Use of EVMs only after user obtains the Technical Regulations Conformity Certification as provided in Radio Law of Japan with respect to EVMs. Also, do not transfer EVMs, unless user gives the same notice above to the transferee. Please note that if user does not follow the instructions above, user will be subject to penalties of Radio Law of Japan.

<http://www.tij.co.jp>

【無線電波を送信する製品の開発キットをお使いになる際の注意事項】本開発キットは技術基準適合証明を受けておりません。本製品のご使用に際しては、電波法遵守のため、以下のいずれかの措置を取っていただく必要がありますのでご注意ください。

1. 電波法施行規則第6条第1項第1号に基づく平成18年3月28日総務省告示第173号で定められた電波暗室等の試験設備でご使用いただく。
2. 実験局の免許を取得後ご使用いただく。
3. 技術基準適合証明を取得後ご使用いただく。。

なお、本製品は、上記の「ご使用にあたっての注意」を譲渡先、移転先に通知しない限り、譲渡、移転できないものとします

上記を遵守頂けない場合は、電波法の罰則が適用される可能性があることをご留意ください。

日本テキサス・インスツルメンツ株式会社

東京都新宿区西新宿6丁目24番1号

西新宿三井ビル

<http://www.tij.co.jp>

Texas Instruments Japan Limited

(address) 24-1, Nishi-Shinjuku 6 chome, Shinjuku-ku, Tokyo, Japan

IMPORTANT NOTICE

Texas Instruments Incorporated and its subsidiaries (TI) reserve the right to make corrections, enhancements, improvements and other changes to its semiconductor products and services per JESD46, latest issue, and to discontinue any product or service per JESD48, latest issue. Buyers should obtain the latest relevant information before placing orders and should verify that such information is current and complete. All semiconductor products (also referred to herein as "components") are sold subject to TI's terms and conditions of sale supplied at the time of order acknowledgment.

TI warrants performance of its components to the specifications applicable at the time of sale, in accordance with the warranty in TI's terms and conditions of sale of semiconductor products. Testing and other quality control techniques are used to the extent TI deems necessary to support this warranty. Except where mandated by applicable law, testing of all parameters of each component is not necessarily performed.

TI assumes no liability for applications assistance or the design of Buyers' products. Buyers are responsible for their products and applications using TI components. To minimize the risks associated with Buyers' products and applications, Buyers should provide adequate design and operating safeguards.

TI does not warrant or represent that any license, either express or implied, is granted under any patent right, copyright, mask work right, or other intellectual property right relating to any combination, machine, or process in which TI components or services are used. Information published by TI regarding third-party products or services does not constitute a license to use such products or services or a warranty or endorsement thereof. Use of such information may require a license from a third party under the patents or other intellectual property of the third party, or a license from TI under the patents or other intellectual property of TI.

Reproduction of significant portions of TI information in TI data books or data sheets is permissible only if reproduction is without alteration and is accompanied by all associated warranties, conditions, limitations, and notices. TI is not responsible or liable for such altered documentation. Information of third parties may be subject to additional restrictions.

Resale of TI components or services with statements different from or beyond the parameters stated by TI for that component or service voids all express and any implied warranties for the associated TI component or service and is an unfair and deceptive business practice. TI is not responsible or liable for any such statements.

Buyer acknowledges and agrees that it is solely responsible for compliance with all legal, regulatory and safety-related requirements concerning its products, and any use of TI components in its applications, notwithstanding any applications-related information or support that may be provided by TI. Buyer represents and agrees that it has all the necessary expertise to create and implement safeguards which anticipate dangerous consequences of failures, monitor failures and their consequences, lessen the likelihood of failures that might cause harm and take appropriate remedial actions. Buyer will fully indemnify TI and its representatives against any damages arising out of the use of any TI components in safety-critical applications.

In some cases, TI components may be promoted specifically to facilitate safety-related applications. With such components, TI's goal is to help enable customers to design and create their own end-product solutions that meet applicable functional safety standards and requirements. Nonetheless, such components are subject to these terms.

No TI components are authorized for use in FDA Class III (or similar life-critical medical equipment) unless authorized officers of the parties have executed a special agreement specifically governing such use.

Only those TI components which TI has specifically designated as military grade or "enhanced plastic" are designed and intended for use in military/aerospace applications or environments. Buyer acknowledges and agrees that any military or aerospace use of TI components which have **not** been so designated is solely at the Buyer's risk, and that Buyer is solely responsible for compliance with all legal and regulatory requirements in connection with such use.

TI has specifically designated certain components as meeting ISO/TS16949 requirements, mainly for automotive use. In any case of use of non-designated products, TI will not be responsible for any failure to meet ISO/TS16949.

Products

Audio	www.ti.com/audio
Amplifiers	amplifier.ti.com
Data Converters	dataconverter.ti.com
DLP® Products	www.dlp.com
DSP	dsp.ti.com
Clocks and Timers	www.ti.com/clocks
Interface	interface.ti.com
Logic	logic.ti.com
Power Mgmt	power.ti.com
Microcontrollers	microcontroller.ti.com
RFID	www.ti-rfid.com
OMAP Applications Processors	www.ti.com/omap
Wireless Connectivity	www.ti.com/wirelessconnectivity

Applications

Automotive and Transportation	www.ti.com/automotive
Communications and Telecom	www.ti.com/communications
Computers and Peripherals	www.ti.com/computers
Consumer Electronics	www.ti.com/consumer-apps
Energy and Lighting	www.ti.com/energy
Industrial	www.ti.com/industrial
Medical	www.ti.com/medical
Security	www.ti.com/security
Space, Avionics and Defense	www.ti.com/space-avionics-defense
Video and Imaging	www.ti.com/video

TI E2E Community

e2e.ti.com

Компания «Океан Электроники» предлагает заключение долгосрочных отношений при поставках импортных электронных компонентов на взаимовыгодных условиях!

Наши преимущества:

- Поставка оригинальных импортных электронных компонентов напрямую с производств Америки, Европы и Азии, а так же с крупнейших складов мира;
- Широкая линейка поставок активных и пассивных импортных электронных компонентов (более 30 млн. наименований);
- Поставка сложных, дефицитных, либо снятых с производства позиций;
- Оперативные сроки поставки под заказ (от 5 рабочих дней);
- Экспресс доставка в любую точку России;
- Помощь Конструкторского Отдела и консультации квалифицированных инженеров;
- Техническая поддержка проекта, помощь в подборе аналогов, поставка прототипов;
- Поставка электронных компонентов под контролем ВП;
- Система менеджмента качества сертифицирована по Международному стандарту ISO 9001;
- При необходимости вся продукция военного и аэрокосмического назначения проходит испытания и сертификацию в лаборатории (по согласованию с заказчиком);
- Поставка специализированных компонентов военного и аэрокосмического уровня качества (Xilinx, Altera, Analog Devices, Intersil, Interpoint, Microsemi, Actel, Aeroflex, Peregrine, VPT, Syfer, Eurofarad, Texas Instruments, MS Kennedy, Miteq, Cobham, E2V, MA-COM, Hittite, Mini-Circuits, General Dynamics и др.);

Компания «Океан Электроники» является официальным дистрибьютором и эксклюзивным представителем в России одного из крупнейших производителей разъемов военного и аэрокосмического назначения «**JONHON**», а так же официальным дистрибьютором и эксклюзивным представителем в России производителя высокотехнологичных и надежных решений для передачи СВЧ сигналов «**FORSTAR**».



JONHON

«**JONHON**» (основан в 1970 г.)

Разъемы специального, военного и аэрокосмического назначения:

(Применяются в военной, авиационной, аэрокосмической, морской, железнодорожной, горно- и нефтедобывающей отраслях промышленности)

«**FORSTAR**» (основан в 1998 г.)

ВЧ соединители, коаксиальные кабели, кабельные сборки и микроволновые компоненты:

(Применяются в телекоммуникациях гражданского и специального назначения, в средствах связи, РЛС, а так же военной, авиационной и аэрокосмической отраслях промышленности).



Телефон: 8 (812) 309-75-97 (многоканальный)

Факс: 8 (812) 320-03-32

Электронная почта: ocean@oceanchips.ru

Web: <http://oceanchips.ru/>

Адрес: 198099, г. Санкт-Петербург, ул. Калинина, д. 2, корп. 4, лит. А