

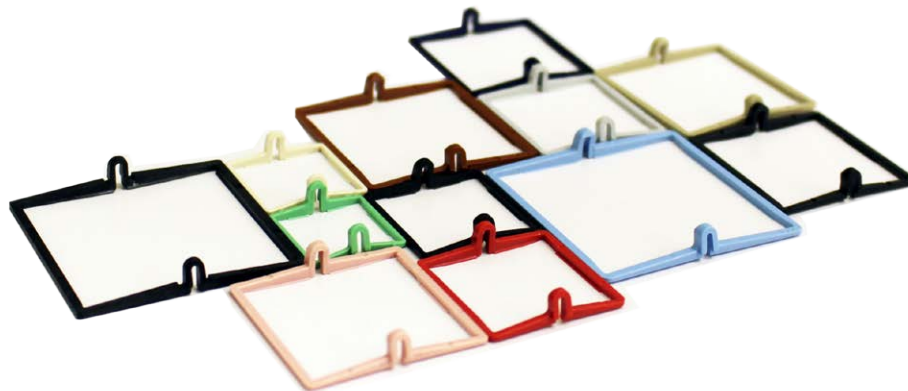

clipKIT™

THE BEST HEAT SINK ATTACHMENT TECHNOLOGY ON THE MARKET

- Patented superGRIP™ and maxiGRIP™ technology available for straight fin, slant fin, cross cut and pin fin heat sinks
- To be used with heat sinks that have a 1.75 to 4mm base thickness
- Plastic frame and stainless steel spring clips available for 15mm to 45mm components
- Secure heat sink attachment system passes Telcordia Shock & Vibration standards
- Attachment force improves TIM performance by up to 20%
- Eliminates the need to drill holes in a PCB & allows the heat sink to be detached and reattached without damaging the component



Advanced Thermal Solutions, Inc., has introduced clipKIT™ the ultimate heat sink attachment system that can be used with straight fin, pin fin, cross cut or slant fin heat sinks. clipKIT™ is a line of patented, reliable heat sink attachment assemblies featuring the widely used maxiGRIP™ and superGRIP™ frame clip and spring clip. clipKIT™ is available for 15 – 45mm component packages and is designed for standard heat sinks that have a base thickness of 1.75 to 4mm.

Instead of relying on thermal tape or epoxy, which can damage the board or component during rework, the reliable clip attachment system provides a secure hold without the risk of damaging the component or PCB, saving time and cost. The ultra-thin plastic frame clip and stainless steel spring clip are corrosion-resistant, flame retardant and pass Telcordia shock and vibration standards, ensuring the heat sink will securely stay in place on the component in harsh conditions. clipKIT™ attachments eliminate the need to drill holes in a PCB, saving additional board and rework costs. The thin frame clip occupies minimal space around the components perimeter, compared to push pin attachments or stand-off hardware which leaves little space on already overcrowded PCBs. The two-part attachment system provides a uniform force which enhancing heat transfer and improves TIM performance by up to 20%.



maxiGRIP™ Spring (above) & Frame Clips (below)

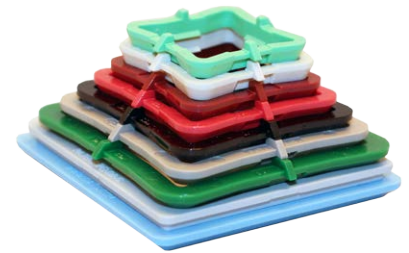

COMPONENT SIZES

- 15 mm x 15 mm
- 17 mm x 17 mm
- 19 mm x 19 mm
- 21 mm x 21 mm
- 23 mm x 23 mm
- 25 mm x 25 mm
- 27 mm x 27 mm
- 29 mm x 29 mm
- 30 mm x 30 mm
- 31 mm x 31 mm
- 32.5 mm x 32.5 mm
- 33 mm x 33 mm
- 35 mm x 35 mm
- 37.5 mm x 37.5 mm
- 40 mm x 40 mm
- 42.5 mm x 42.5 mm
- 45 mm x 45 mm

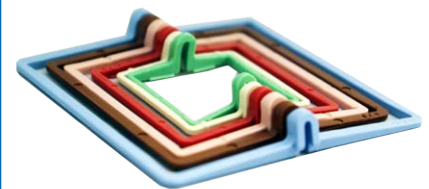

superGRIP™ Frame (above) & Spring Clips (below)





maxiGRIP™
ASSEMBLY

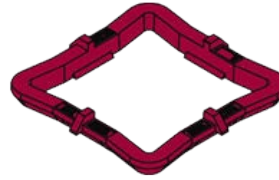
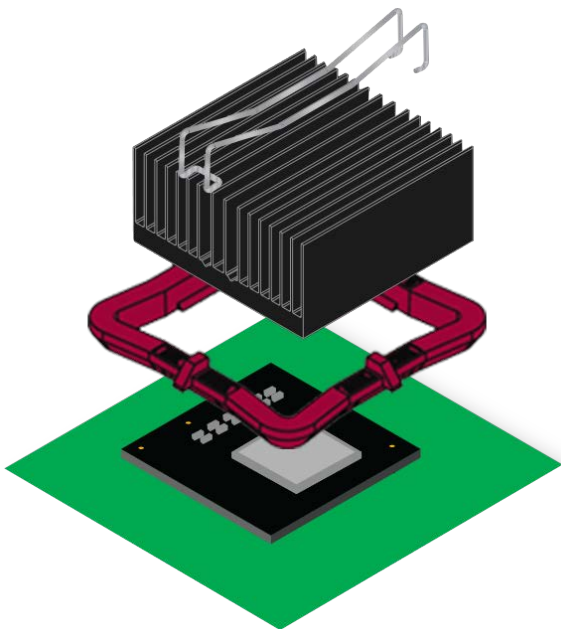

FRAME CLIP

- High-strength, high-performance plastic meets stringent UL-94V-0 fire rating which has exceptional thermal stability
- Frame geometry has been optimized for strength and minimal space requirements
- Tapered wall provides clearance for adjacent components
- Hour glass shape provides additional room for metal spring clip
- Uniformity in design allows for omnidirectional frame clip orientation



SPRING CLIP

- Metal spring clip, placed through the heat sink's fin field, locks securely to both ends to the plastic frame
- Double "M" shape provides steady, even pressure to the component, improving thermal performance and long-term reliability
- Spring clip is quickly installed with the maxiGRIP™ Installation Tool
- Specifically designed for different component heights.
- Imposes minimal restriction to air flow
- Accommodates varied fin-to-fin spacing

superGRIP™
ASSEMBLY

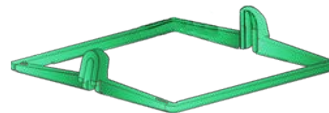
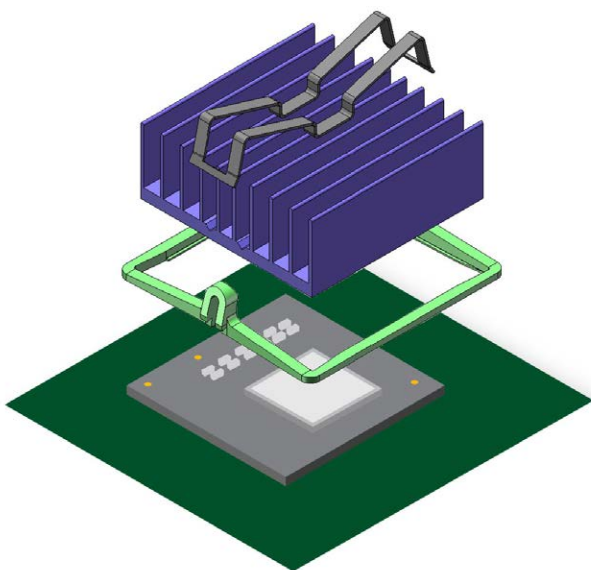

FRAME CLIP

- Thin, yet strong plastic Frame Clip occupies minimal area around chip, allowing its use in densely populated PCBs
- No custom installation tooling required— mounts easily by hand.
- Interior frame profile locks securely around bottom edge and sides of component package
- Integral horseshoe tabs in clip lock in Spring Clip edges for tight, movement-free heat sink retention
- Frame Clip is easily and safely removed with a common hand tool



SPRING CLIP

- Metal spring clip, placed through the heat sink's fin field, locks securely to both ends of the plastic frame
- Applies a steady, even pressure to the component, improving thermal performance and long-term reliability
- Spring Clip design is quickly installed or released using a common hand tool, such as a flat blade screwdriver
- Flat, twin-channel clip provides stronger retention forces and minimizes spring clip movement



clipKIT™ Packages

COMPONENT SIZE	ASSEMBLY	PART NUMBER
15x15mm	superGRIP™	ATS-SG150-R0
17x17mm	maxiGRIP™	ATS-MG170-R0
17x17mm	superGRIP™	ATS-SG170-R0
19x19mm	maxiGRIP™	ATS-MG190-R0
19x19mm	superGRIP™	ATS-SG190-R0
21x21mm	maxiGRIP™	ATS-MG210-R0
21x21mm	superGRIP™	ATS-SG210-R0
23x23mm	maxiGRIP™	ATS-MG230-R0
23x23mm	superGRIP™	ATS-SG230-R0
25x25mm	maxiGRIP™	ATS-MG250-R0
25x25mm	superGRIP™	ATS-SG250-R0
27x27mm	maxiGRIP™	ATS-MG270-R0
27x27mm	superGRIP™	ATS-SG270-R0
29x29mm	maxiGRIP™	ATS-MG290-R0
29x29mm	superGRIP™	ATS-SG290-R0
30x30mm	maxiGRIP™	ATS-MG300-R0
30x30mm	superGRIP™	ATS-SG300-R0
31x31mm	maxiGRIP™	ATS-MG310-R0
31x31mm	superGRIP™	ATS-SG310-R0
32.5x32.5mm	maxiGRIP™	ATS-MG325-R0
32.5x32.5mm	superGRIP™	ATS-SG325-R0
33x33mm	maxiGRIP™	ATS-MG330-R0
33x33mm	superGRIP™	ATS-SG330-R0
35x35mm	maxiGRIP™	ATS-MG350-R0
35x35mm	superGRIP™	ATS-SG350-R0
37.5x37.5mm	maxiGRIP™	ATS-MG375-R0
37.5x37.5mm	superGRIP™	ATS-SG375-R0
40x40mm	maxiGRIP™	ATS-MG400-R0
40x40mm	superGRIP™	ATS-SG400-R0
42.5x42.5mm	maxiGRIP™	ATS-MG425-R0
42.5x42.5mm	superGRIP™	ATS-SG425-R0
45x45mm	maxiGRIP™	ATS-MG450-R0
45x45mm	superGRIP™	ATS-SG450-R0

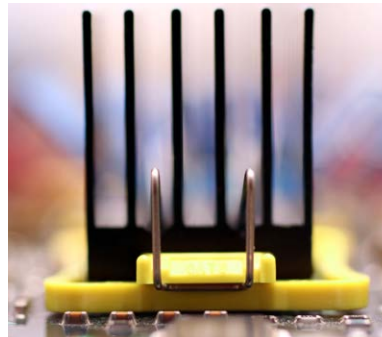

maxiGRIP™ Assembly

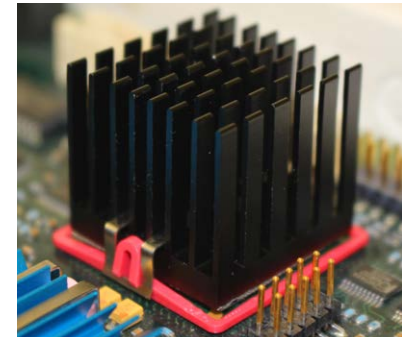
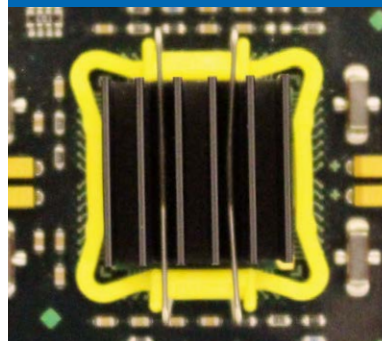

superGRIP™ Assembly

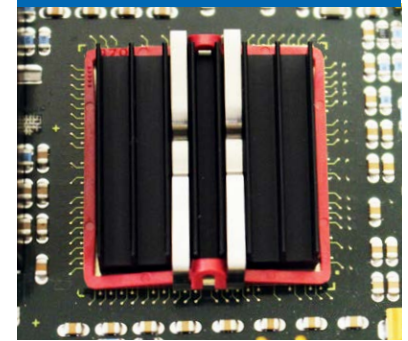

GUIDELINES FOR DETERMINING HEAT SINK COMPATIBILITY WITH clipKIT™

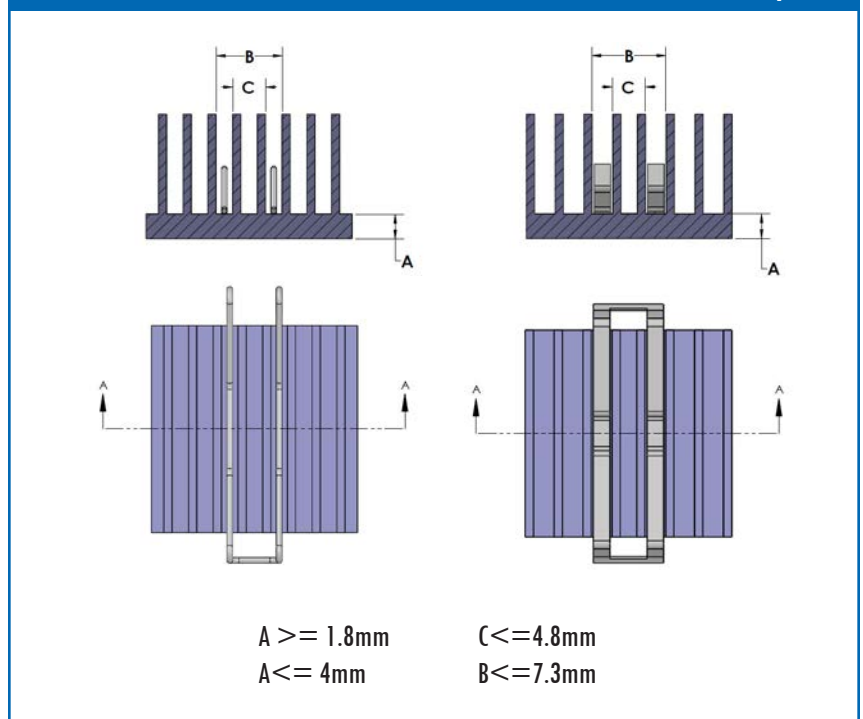



ATS ADVANCED
THERMAL
SOLUTIONS, INC.
Innovations in Thermal Management®

We Have Your PCB Covered

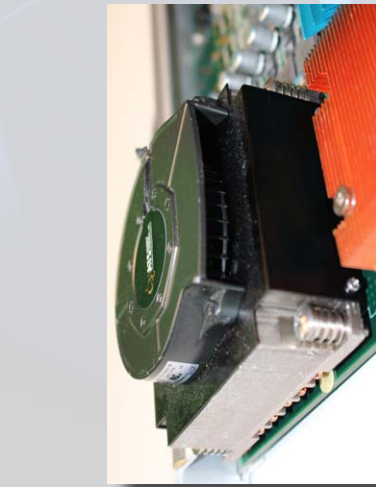

CPU Cooler

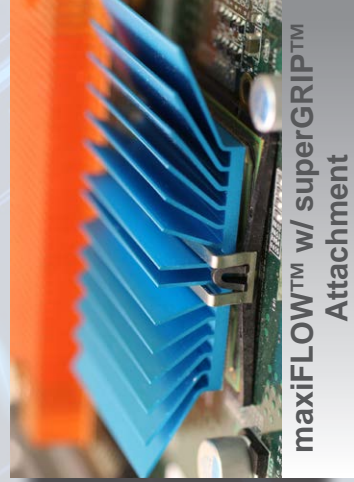

maxiFLOW™ w/ superGRIP™
Attachment

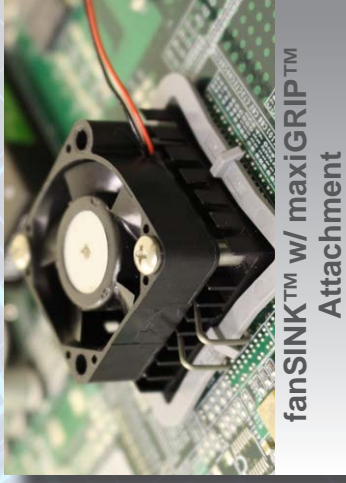

fanSINK™ w/ maxiGRIP™
Attachment

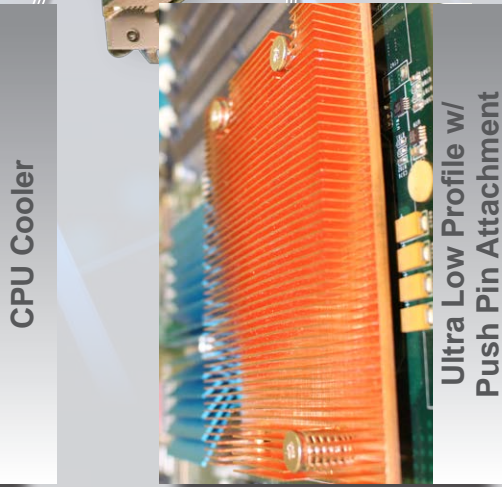

Ultra Low Profile w/
Push Pin Attachment



Power Brick Heat Sink

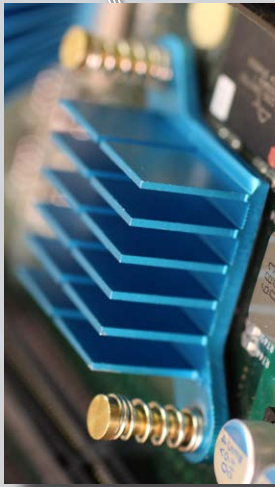
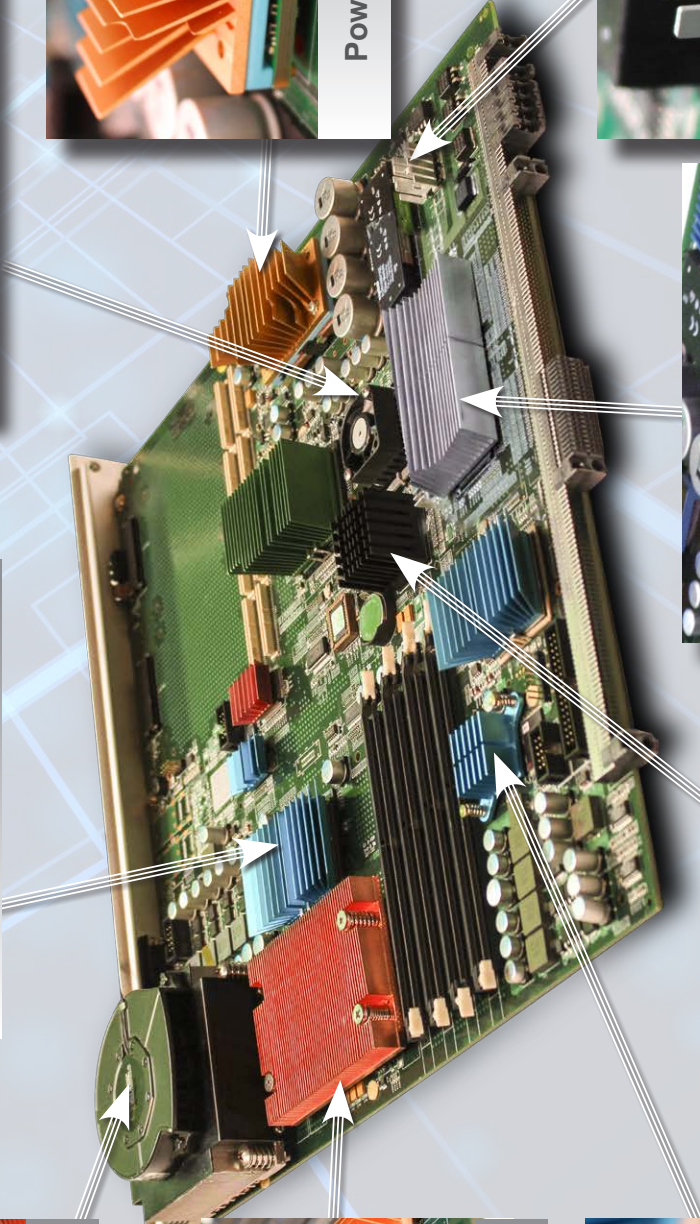

pushPIN™ Heat Sinks

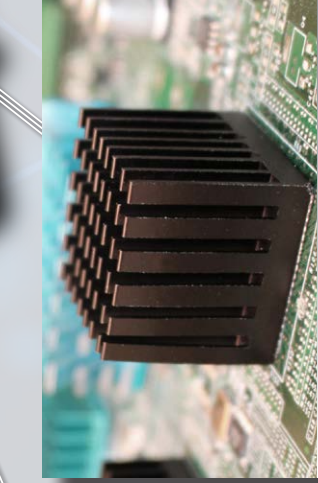

Cross Cut Heat Sink



Extrusion Profile Heat Sink

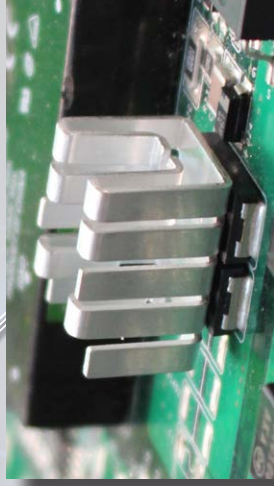

Standard Board Level Heat Sink

Компания «Океан Электроники» предлагает заключение долгосрочных отношений при поставках импортных электронных компонентов на взаимовыгодных условиях!

Наши преимущества:

- Поставка оригинальных импортных электронных компонентов напрямую с производств Америки, Европы и Азии, а так же с крупнейших складов мира;
- Широкая линейка поставок активных и пассивных импортных электронных компонентов (более 30 млн. наименований);
- Поставка сложных, дефицитных, либо снятых с производства позиций;
- Оперативные сроки поставки под заказ (от 5 рабочих дней);
- Экспресс доставка в любую точку России;
- Помощь Конструкторского Отдела и консультации квалифицированных инженеров;
- Техническая поддержка проекта, помощь в подборе аналогов, поставка прототипов;
- Поставка электронных компонентов под контролем ВП;
- Система менеджмента качества сертифицирована по Международному стандарту ISO 9001;
- При необходимости вся продукция военного и аэрокосмического назначения проходит испытания и сертификацию в лаборатории (по согласованию с заказчиком);
- Поставка специализированных компонентов военного и аэрокосмического уровня качества (Xilinx, Altera, Analog Devices, Intersil, Interpoint, Microsemi, Actel, Aeroflex, Peregrine, VPT, Syfer, Eurofarad, Texas Instruments, MS Kennedy, Miteq, Cobham, E2V, MA-COM, Hittite, Mini-Circuits, General Dynamics и др.);

Компания «Океан Электроники» является официальным дистрибьютором и эксклюзивным представителем в России одного из крупнейших производителей разъемов военного и аэрокосмического назначения «JONHON», а так же официальным дистрибьютором и эксклюзивным представителем в России производителя высокотехнологичных и надежных решений для передачи СВЧ сигналов «FORSTAR».



JONHON

«JONHON» (основан в 1970 г.)

Разъемы специального, военного и аэрокосмического назначения:

(Применяются в военной, авиационной, аэрокосмической, морской, железнодорожной, горно- и нефтедобывающей отраслях промышленности)

«FORSTAR» (основан в 1998 г.)

ВЧ соединители, коаксиальные кабели, кабельные сборки и микроволновые компоненты:

(Применяются в телекоммуникациях гражданского и специального назначения, в средствах связи, РЛС, а так же военной, авиационной и аэрокосмической отраслях промышленности).



Телефон: 8 (812) 309-75-97 (многоканальный)

Факс: 8 (812) 320-03-32

Электронная почта: ocean@oceanchips.ru

Web: <http://oceanchips.ru/>

Адрес: 198099, г. Санкт-Петербург, ул. Калинина, д. 2, корп. 4, лит. А