



N-Channel Depletion-Mode DMOS FET

Features

- ▶ Free from secondary breakdown
- ▶ Low power drive requirement
- ▶ Ease of paralleling
- ▶ Excellent thermal stability
- ▶ Integral source-drain diode
- ▶ High input impedance and low C_{ISS}
- ▶ ESD gate protection

Applications

- ▶ Solid state relays
- ▶ Normally-on switches
- ▶ Converters
- ▶ Power supply circuits
- ▶ Constant current sources
- ▶ Input protection circuits

General Description

The LND150 is a high voltage N-channel depletion mode (normally-on) transistor utilizing Supertex's lateral DMOS technology. The gate is ESD protected.

The LND150 is ideal for high voltage applications in the areas of normally-on switches, precision constant current sources, voltage ramp generation and amplification.

Ordering Information

Part Number	Package Options	Packing
LND150K1-G	TO-236AB (SOT-23)	3000/Reel
LND150N3-G	TO-92	1000/Bag
LND150N3-G P002	TO-92	2000/Reel
LND150N3-G P003	TO-92	2000/Reel
LND150N3-G P005	TO-92	2000/Reel
LND150N3-G P013	TO-92	2000/Reel
LND150N3-G P014	TO-92	2000/Reel
LND150N8-G	TO-243AA (SOT-89)	2000/Reel

-G denotes a lead (Pb)-free / RoHS compliant package

Product Summary

BV_{DSX}/BV_{DGX} (V)	$R_{DS(ON)}$ (max)	I_{DSS} (min)
500	1.0kΩ	1.0mA

Pin Configuration

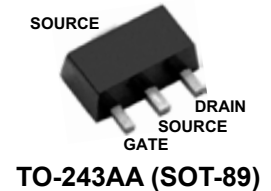
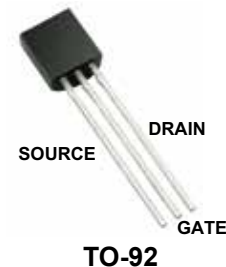

Absolute Maximum Ratings

Parameter	Value
Drain-to-source	BV_{DSX}
Drain-to-gate	BV_{DGX}
Gate-to-source	±20V
Operating and storage temperature	-55°C to +150°C

Absolute Maximum Ratings are those values beyond which damage to the device may occur. Functional operation under these conditions is not implied. Continuous operation of the device at the absolute rating level may affect device reliability. All voltages are referenced to device ground.

Product Marking

NDEW W = Code for Week Sealed
 = "Green" Packaging

TO-236AB (SOT-23)

SiLN YY = Year Sealed
D 1 5 0 WW = Week Sealed
YYWW = "Green" Packaging

TO-92

LN1EW W = Code for Week Sealed
 = "Green" Packaging

TO-243AA (SOT-89)

Packages may or may not include the following marks: Si or

Thermal Characteristics

Package	I_D (continuous) [†] (mA)	I_D (pulsed) (mA)	Power Dissipation @ $T_A = 25^\circ\text{C}$ (W)	θ_{ja} ($^\circ\text{C}/\text{W}$)	I_{DR} (mA)	I_{DRM}^{\dagger} (mA)
TO-236AB (SOT-23)	13	30	0.36	203	13	30
TO-92	30	30	0.74	132	30	30
TO-243AA (SOT-89)	30	30	1.6 [‡]	133	30	30

Notes:

[†] I_D (continuous) is limited by max rated T_j .

Electrical Characteristics ($T_A = 25^\circ\text{C}$ unless otherwise specified)

Sym	Parameter	Min	Typ	Max	Units	Conditions
BV_{DSX}	Drain-to-source breakdown voltage	500	-	-	V	$V_{GS} = -10\text{V}$, $I_D = 1.0\text{mA}$
$V_{GS(OFF)}$	Gate-to-source off voltage	-1.0	-	-3.0	V	$V_{GS} = 25\text{V}$, $I_D = 100\text{nA}$
$\Delta V_{GS(OFF)}$	Change in $V_{GS(OFF)}$ with temperature	-	-	5.0	mV/ $^\circ\text{C}$	$V_{GS} = 25\text{V}$, $I_D = 100\text{nA}$
I_{GSS}	Gate body leakage current	-	-	100	nA	$V_{GS} = \pm 20\text{V}$, $V_{DS} = 0\text{V}$
$I_{D(OFF)}$	Drain-to-source leakage current	-	-	100	nA	$V_{GS} = -10\text{V}$, $V_{DS} = 450\text{V}$
		-	-	100	μA	$V_{DS} = 0.8\text{V}$ Max Rating, $V_{GS} = -10\text{V}$, $T_A = 125^\circ\text{C}$
I_{DSS}	Saturated drain-to-source current	1.0	-	3.0	mA	$V_{GS} = 0\text{V}$, $V_{DS} = 25\text{V}$
$R_{DS(ON)}$	Static drain-to-source on-state resistance	-	850	1000	Ω	$V_{GS} = 0\text{V}$, $I_D = 0.5\text{mA}$
$\Delta R_{DS(ON)}$	Change in $R_{DS(ON)}$ with temperature	-	-	1.2	%/ $^\circ\text{C}$	$V_{GS} = 0\text{V}$, $I_D = 0.5\text{mA}$
G_{FS}	Forward transductance	1.0	2.0	-	m $\bar{\Omega}$	$V_{DS} = 0\text{V}$, $I_D = 1.0\text{mA}$
C_{ISS}	Input capacitance	-	7.5	10	pF	$V_{GS} = -10\text{V}$, $V_{DS} = 25\text{V}$, $f = 1.0\text{MHz}$
C_{OSS}	Common source output capacitance	-	2.0	3.5		
C_{RSS}	Reverse transfer capacitance	-	0.5	1.0		
$t_{d(ON)}$	Turn-on delay time	-	0.09	-	μs	$V_{DD} = 25\text{V}$, $I_D = 1.0\text{mA}$, $R_{GEN} = 25\Omega$
t_r	Rise time	-	0.45	-		
$t_{d(OFF)}$	Turn-off delay time	-	0.1	-		
t_f	Fall time	-	1.3	-		
V_{SD}	Diode forward voltage drop	-	-	0.9	V	$V_{GS} = -10\text{V}$, $I_{SD} = 1.0\text{mA}$
t_{rr}	Reverse recovery time	-	200	-	ns	$V_{GS} = -10\text{V}$, $I_{SD} = 1.0\text{mA}$

Notes:

- All D.C. parameters 100% tested at 25°C unless otherwise stated. (Pulse test: 300 μs pulse, 2% duty cycle.)
- All A.C. parameters sample tested.

Switching Waveforms and Test Circuit

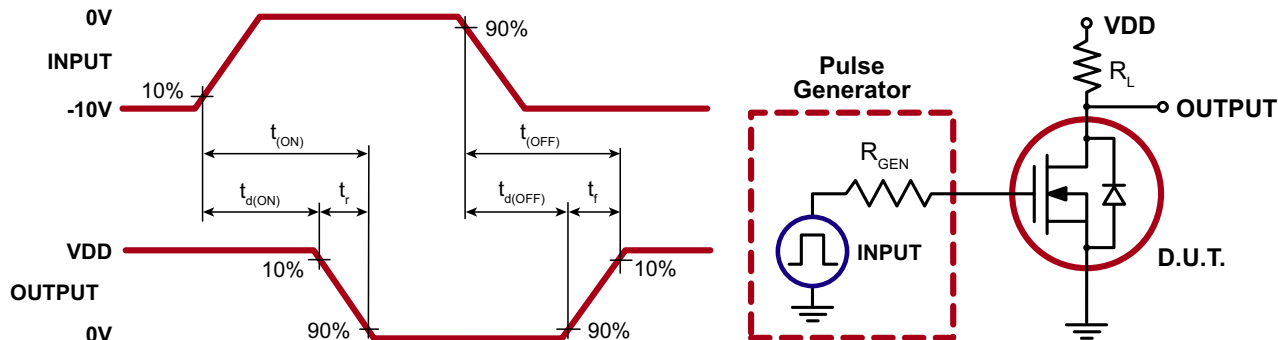

Typical Performance Curves

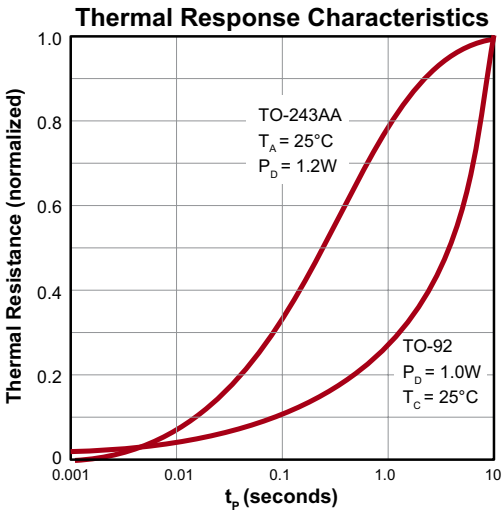
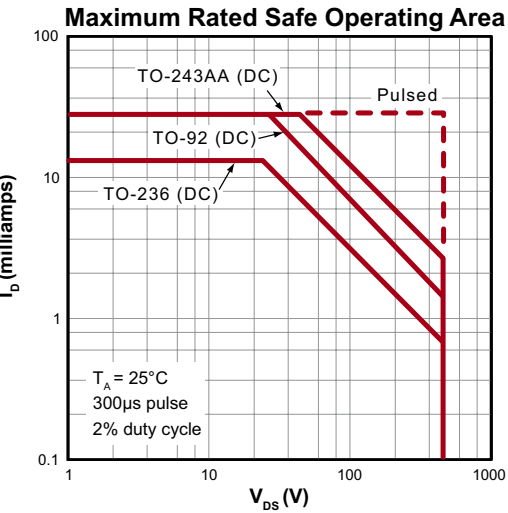
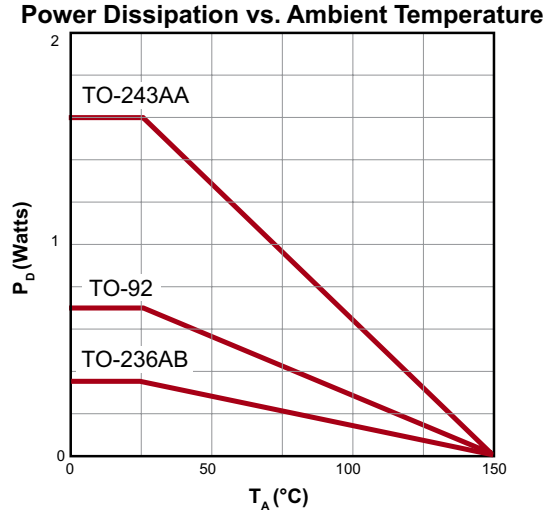
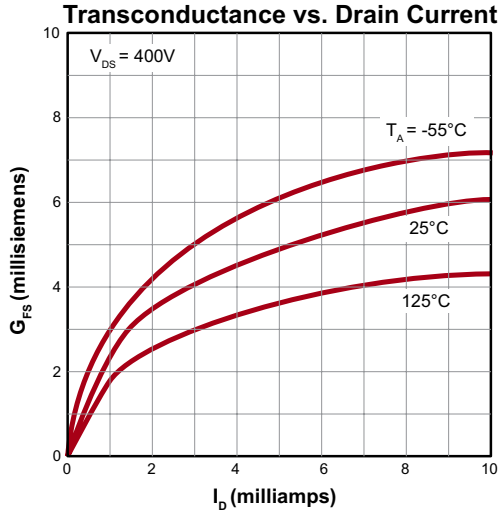
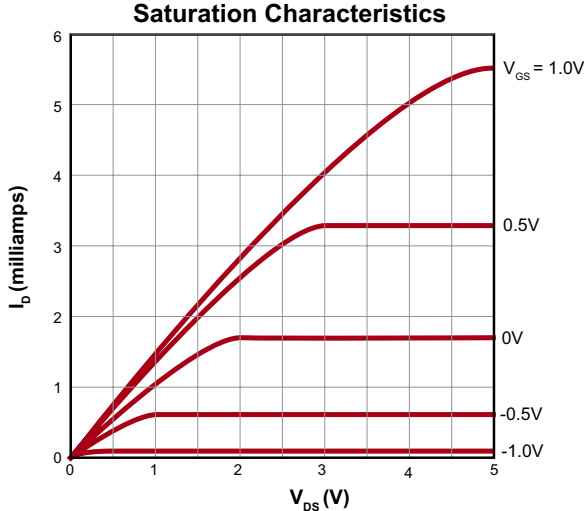
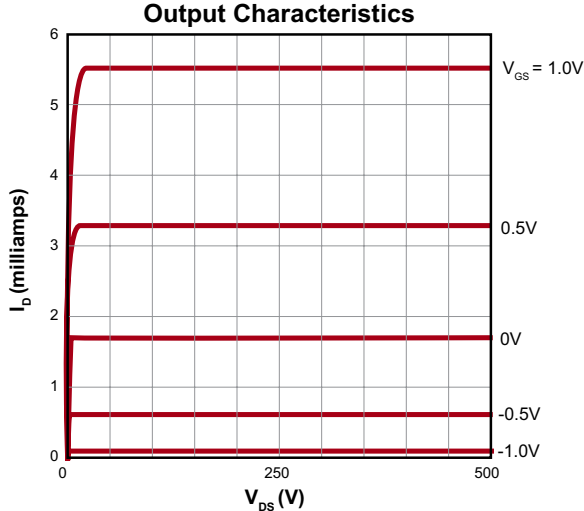

Typical Performance Curves (cont.)

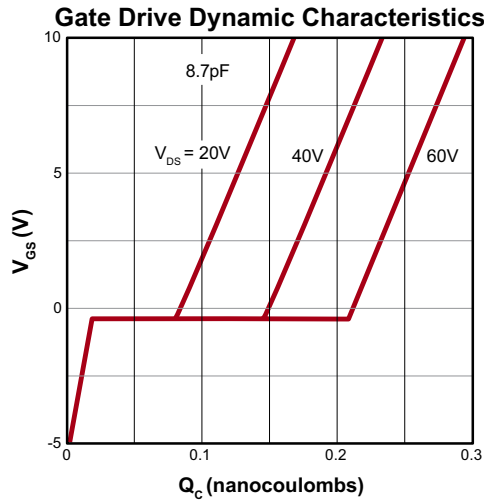
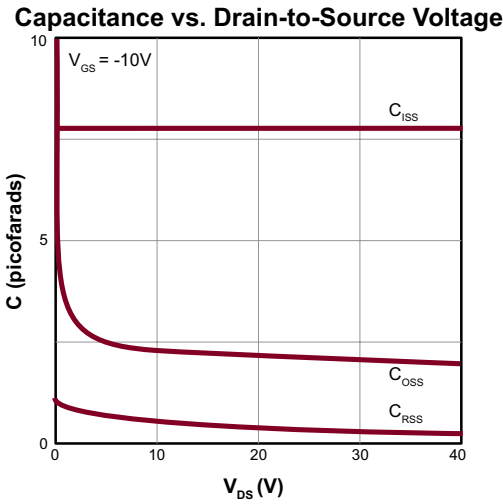
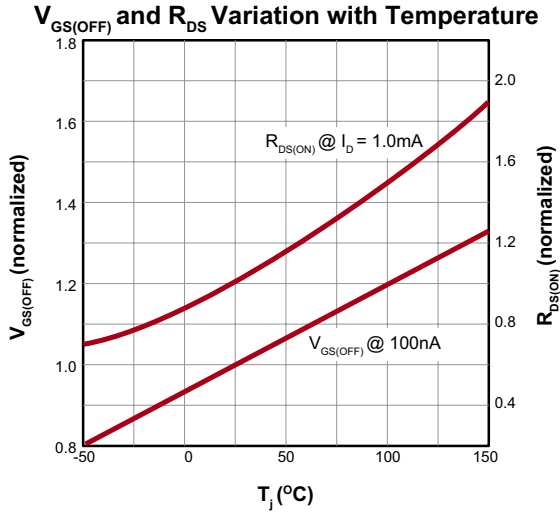
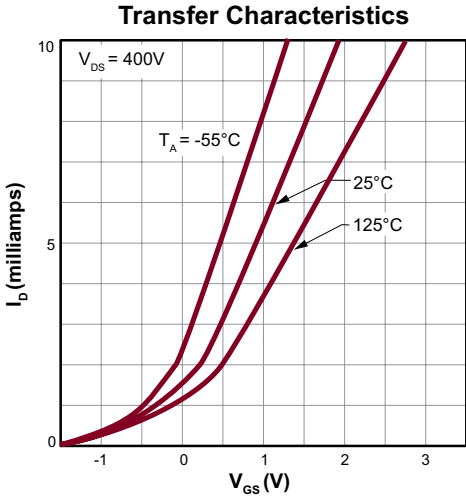
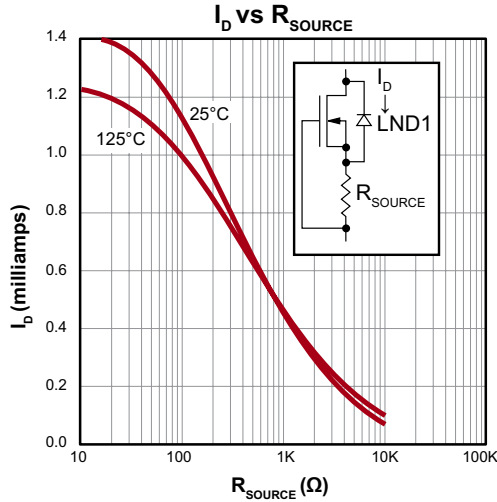
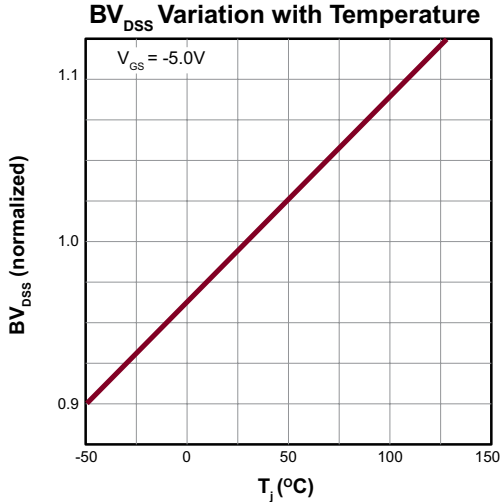

3-Lead TO-236AB (SOT-23) Package Outline (K1)

2.90x1.30mm body, 1.12mm height (max), 1.90mm pitch

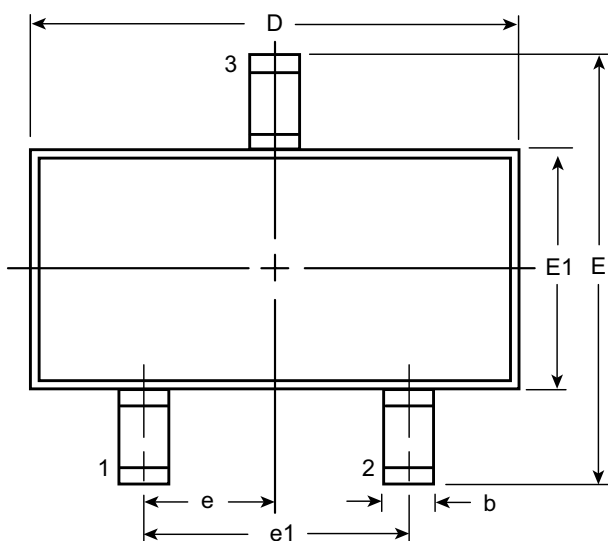

Top View

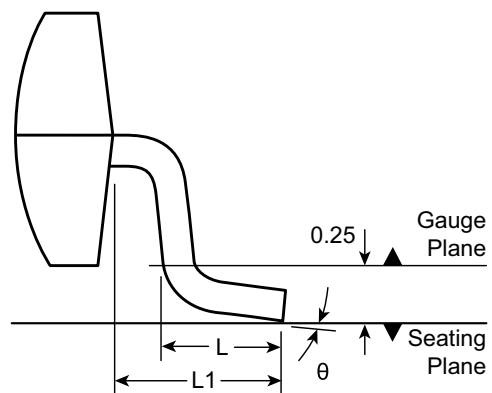

View B

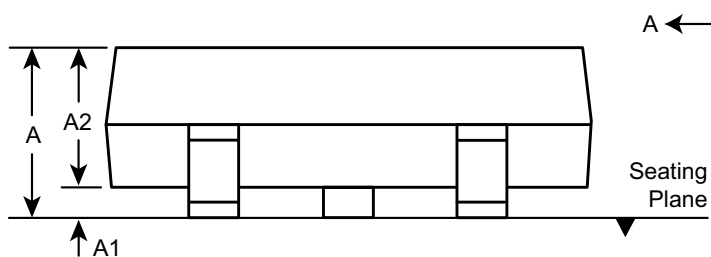

Side View

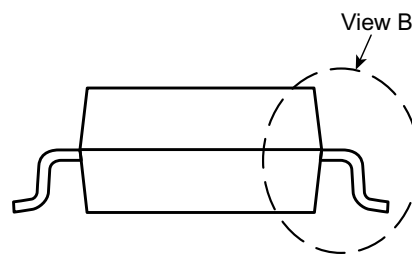

View A - A

Symbol		A	A1	A2	b	D	E	E1	e	e1	L	L1	θ
Dimension (mm)	MIN	0.89	0.01	0.88	0.30	2.80	2.10	1.20	0.95 BSC	1.90 BSC	0.20 [†]	0.54 REF	0°
	NOM	-	-	0.95	-	2.90	-	1.30			0.50		-
	MAX	1.12	0.10	1.02	0.50	3.04	2.64	1.40			0.60		8°

JEDEC Registration TO-236, Variation AB, Issue H, Jan. 1999.

[†] This dimension differs from the JEDEC drawing.

Drawings not to scale.

Supertex Doc.#: DSPD-3TO236ABK1, Version C041309.

3-Lead TO-92 Package Outline (N3)

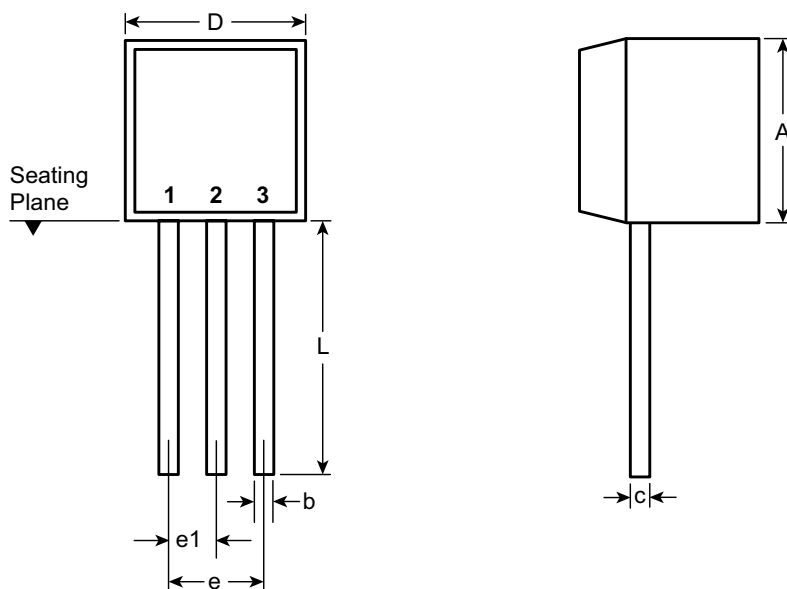

Front View

Side View

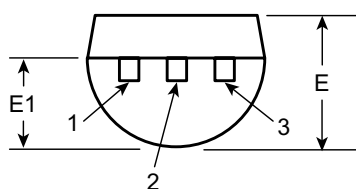

Bottom View

Symbol		A	b	c	D	E	E1	e	e1	L
Dimensions (inches)	MIN	.170	.014 [†]	.014 [†]	.175	.125	.080	.095	.045	.500
	NOM	-	-	-	-	-	-	-	-	-
	MAX	.210	.022 [†]	.022 [†]	.205	.165	.105	.105	.055	.610*

JEDEC Registration TO-92.

* This dimension is not specified in the JEDEC drawing.

† This dimension differs from the JEDEC drawing.

Drawings not to scale.

Supertex Doc.#: DSPD-3TO92N3, Version E041009.

3-Lead TO-243AA (SOT-89) Package Outline (N8)

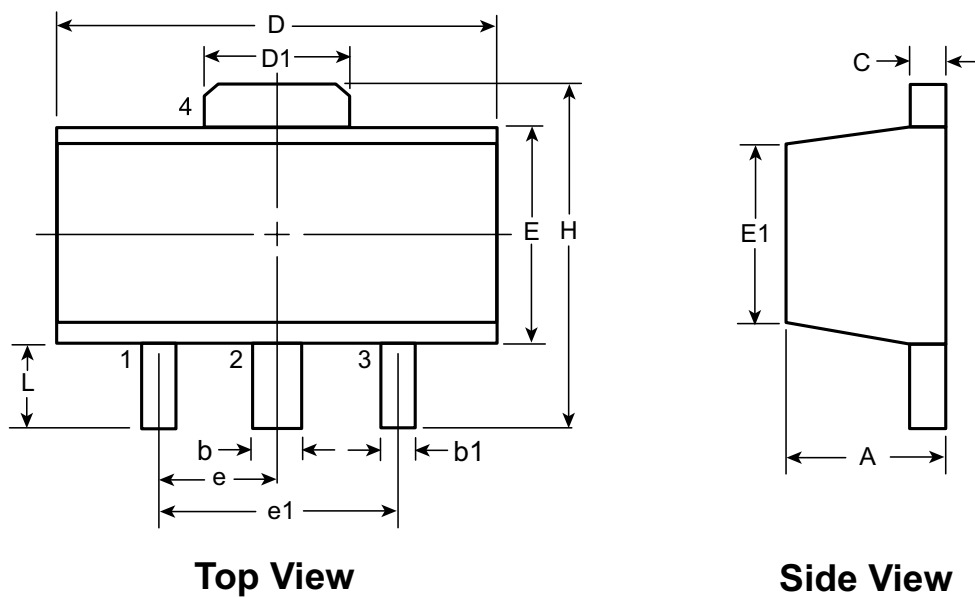

Symbol		A	b	b1	C	D	D1	E	E1	e	e1	H	L
Dimensions (mm)	MIN	1.40	0.44	0.36	0.35	4.40	1.62	2.29	2.00 [†]	1.50 BSC	3.00 BSC	3.94	0.73 [†]
	NOM	-	-	-	-	-	-	-	-			-	-
	MAX	1.60	0.56	0.48	0.44	4.60	1.83	2.60	2.29			4.25	1.20

JEDEC Registration TO-243, Variation AA, Issue C, July 1986.

[†] This dimension differs from the JEDEC drawing

Drawings not to scale.

Supertex Doc. #: DSPD-3TO243AAN8, Version F111010.

(The package drawing(s) in this data sheet may not reflect the most current specifications. For the latest package outline information go to <http://www.supertex.com/packaging.html>.)

Supertex inc. does not recommend the use of its products in life support applications, and will not knowingly sell them for use in such applications unless it receives an adequate "product liability indemnification insurance agreement." **Supertex inc.** does not assume responsibility for use of devices described, and limits its liability to the replacement of the devices determined defective due to workmanship. No responsibility is assumed for possible omissions and inaccuracies. Circuitry and specifications are subject to change without notice. For the latest product specifications refer to the **Supertex inc.** (website: <http://www.supertex.com>)

Компания «Океан Электроники» предлагает заключение долгосрочных отношений при поставках импортных электронных компонентов на взаимовыгодных условиях!

Наши преимущества:

- Поставка оригинальных импортных электронных компонентов напрямую с производств Америки, Европы и Азии, а так же с крупнейших складов мира;
- Широкая линейка поставок активных и пассивных импортных электронных компонентов (более 30 млн. наименований);
- Поставка сложных, дефицитных, либо снятых с производства позиций;
- Оперативные сроки поставки под заказ (от 5 рабочих дней);
- Экспресс доставка в любую точку России;
- Помощь Конструкторского Отдела и консультации квалифицированных инженеров;
- Техническая поддержка проекта, помощь в подборе аналогов, поставка прототипов;
- Поставка электронных компонентов под контролем ВП;
- Система менеджмента качества сертифицирована по Международному стандарту ISO 9001;
- При необходимости вся продукция военного и аэрокосмического назначения проходит испытания и сертификацию в лаборатории (по согласованию с заказчиком);
- Поставка специализированных компонентов военного и аэрокосмического уровня качества (Xilinx, Altera, Analog Devices, Intersil, Interpoint, Microsemi, Actel, Aeroflex, Peregrine, VPT, Syfer, Eurofarad, Texas Instruments, MS Kennedy, Miteq, Cobham, E2V, MA-COM, Hittite, Mini-Circuits, General Dynamics и др.);

Компания «Океан Электроники» является официальным дистрибьютором и эксклюзивным представителем в России одного из крупнейших производителей разъемов военного и аэрокосмического назначения «JONHON», а так же официальным дистрибьютором и эксклюзивным представителем в России производителя высокотехнологичных и надежных решений для передачи СВЧ сигналов «FORSTAR».



JONHON

«JONHON» (основан в 1970 г.)

Разъемы специального, военного и аэрокосмического назначения:

(Применяются в военной, авиационной, аэрокосмической, морской, железнодорожной, горно- и нефтедобывающей отраслях промышленности)

«FORSTAR» (основан в 1998 г.)

ВЧ соединители, коаксиальные кабели, кабельные сборки и микроволновые компоненты:

(Применяются в телекоммуникациях гражданского и специального назначения, в средствах связи, РЛС, а так же военной, авиационной и аэрокосмической отраслях промышленности).



Телефон: 8 (812) 309-75-97 (многоканальный)

Факс: 8 (812) 320-03-32

Электронная почта: ocean@oceanchips.ru

Web: <http://oceanchips.ru/>

Адрес: 198099, г. Санкт-Петербург, ул. Калинина, д. 2, корп. 4, лит. А