

OUTLINE

The RN5RKxx1A/xx1B/xx2A Series are CMOS-based VFM (Chopper) Step-up DC/DC converter ICs with ultra low supply current and high output voltage accuracy.

Each of the RN5RKxx1A/xx1B consists of an oscillator, a VFM control circuit, a driver transistor to have low ON resistance (Lx switch), a reference voltage unit, a high speed comparator, resistors for voltage detection, an Lx switch protection circuit and an internal chip enable circuit. A low ripple, high efficiency step-up DC/DC converter can be composed of this RN5RKxx1A/xx1B with only three external components: an inductor, a diode and a capacitor.

The RN5RKxx2A uses the same chip as what is employed in the RN5RKxx1A/1B IC and has a drive pin (EXT) for an external transistor instead of an Lx pin. As it is possible to load a large output current with a power transistor which has a low saturation voltage, RN5RKxx2A IC is recommendable to users who need an output current as large as between several tens mA and several hundreds mA.

Using the chip enable function, it is possible to make the supply current on standby minimized.

Since the package for these ICs is SOT-23-5 (Mini-mold), high density mounting of the ICs on board is possible.

FEATURES

- Small Number of External Components Only an inductor, a diode and a capacitor
(RN5RKxx1A/xx1B)
- Ultra Low Input Current on Standby..... Typ. $0\mu\text{A}$
- High Output Voltage Accuracy $\pm 2.5\%$
- Low Ripple and Low Noise
- Low Start-up Voltage..... Max. 0.9V
- High Efficiency Typ. 80%
- Including a Driver Transistor with Low ON Resistance
- Two Kinds of Duty Ratio 77% (xx1A, xx2A)/ 55% (xx1B)
- Output Voltage..... Stepwise setting with a step of 0.1V in the range of 2.0V to 5.5V is possible (refer to Selection Guide)
- Low Temperature-Drift Coefficient of Output Voltage..... Typ. $\pm 100\text{ppm}/^\circ\text{C}$
- Small Package SOT-23-5 (Mini-Mold)

APPLICATIONS

- Power source for battery-powered equipment.
- Power source for cameras, camcorders, VCRs, and hand-held communication equipment.
- Power source for those appliances which require higher cell voltage than that of batteries.

BLOCK DIAGRAM

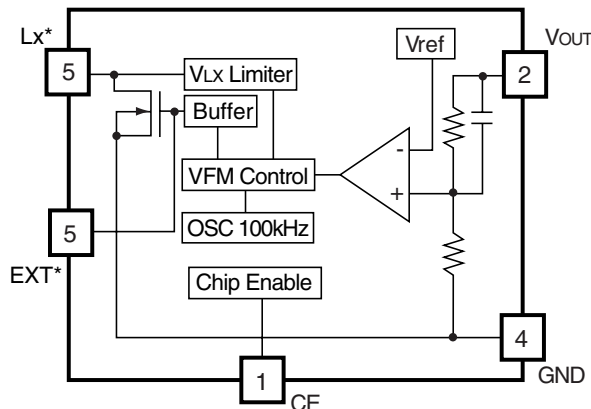

*) Lx pin: only for RN5RKxx1A/xx1B

SELECTION GUIDE

The output voltage, the driver type, the duty cycle and the taping type for the ICs can be selected at the user's request.

The selection can be made by designating the part number as shown below:

RN5RK xxxx-xx ← Part Number
 ↑↑↑↑
 a bc d

Code	Contents
a	Setting Output Voltage (V_{OUT}) : Stepwise setting with a step of 0.1V in the range of 2.0V to 5.5V is possible.
b	Designation of Driver 1: Internal Lx Tr. Driver 2: External Tr. Driver
c	Designation of Duty Cycle A: 77% B: 55%
d	Designation of Taping type Ex. TR, TL (refer to Taping Specifications, TR type is prescribed as a standard.)

PIN CONFIGURATION

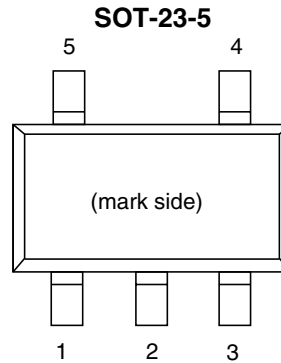

PIN DESCRIPTION

Pin No.	Symbol	Pin description
1	CE	Chip Enable Pin
2	V _{OUT}	Step-up Output Monitoring Pin, Power Supply (for device itself)
3	NC	No Connection
4	GND	Ground Pin
5	L _x	Switching Pin (Nch Open Drain)

Pin No.	Symbol	Pin description
1	CE	Chip Enable Pin
2	V _{OUT}	Step-up Output Monitoring Pin, Power Supply (for device itself)
3	NC	No Connection
4	GND	Ground Pin
5	EXT	External Tr. Drive Pin (CMOS Output)

ABSOLUTE MAXIMUM RATINGS

Symbol	Item	Rating	Unit
V _{OUT}	Step-up Output Pin Voltage	9	V
V _{LX}	Lx Pin Voltage	9	V
V _{EXT}	EXT Pin Voltage	-0.3 to V _{OUT} +0.3	V
V _{CE}	CE Pin Voltage	-0.3 to V _{OUT} +0.3	V
I _{LX}	Lx Pin Output Current	500	mA
I _{EXT}	EXT Pin Output Current	±30	mA
P _D	Power Dissipation	250	mW
T _{opt}	Operating Temperature Range	-40 to +85	°C
T _{stg}	Storage Temperature Range	-55 to +125	°C

ABSOLUTE MAXIMUM RATINGS

Absolute Maximum ratings are threshold limit values that must not be exceeded even for an instant under any conditions. Moreover, such values for any two items must not be reached simultaneously. Operation above these absolute maximum ratings may cause degradation or permanent damage to the device. These are stress ratings only and do not necessarily imply functional operation below these limits.

ELECTRICAL CHARACTERISTICS

• RN5RKxx1A/xx1B

T_{opt}=25°C

Symbol	Item	Conditions	Min.	Typ.	Max.	Unit
V _{OUT}	Output Voltage	V _{IN} =set V _{OUT} ×0.6, I _{OUT} =1mA	×0.975		×1.025	V
V _{IN}	Input Voltage				8	V
ΔV _{OUT} /ΔT _{opt}	Output Voltage Temperature Coefficient	-40°C≤T _{opt} ≤85°C		±100		ppm/°C
V _{start}	Start-Up Voltage	V _{IN} =0V→2V*1		0.75	0.90	V
ΔV _{start} /ΔT _{opt}	Start-Up Voltage Temperature Coefficient	-40°C≤T _{opt} ≤85°C V _{IN} =0V→2V*1		-1.6		mV/°C
V _{hold}	Hold-on Voltage (xx1A)	V _{IN} =2V→0V*1	0.7			V
V _{hold}	Hold-on Voltage (xx1B)	V _{IN} =2V→0V*1	0.9			V
I _{DD2}	Supply Current2	V _{OUT} =V _{CE} =set V _{OUT} +0.5V		2	5	μA
I _{standby}	Standby Current	V _{OUT} =6V, V _{CE} =0V			0.5	μA
I _{LXleak}	Lx Leakage Current	V _{OUT} =V _{LX} =8V			1	μA
f _{osc}	Maximum Oscillator Frequency	V _{OUT} =V _{CE} =set V _{OUT} ×0.96	80	100	120	kHz
Δf _{osc} /ΔT _{opt}	Frequency Temperature Coefficient	-40°C≤T _{opt} ≤85°C		0.41		kHz/°C
Duty	Oscillator Duty Cycle (xx1A)	V _{OUT} =V _{CE} =set V _{OUT} ×0.96, ON (VLx “L” side)	70	77	85	%
Duty	Oscillator Duty Cycle (xx1B)	V _{OUT} =V _{CE} =set V _{OUT} ×0.96, ON (VLx “L” side)	47	55	63	%
V _{Lxlim}	VLx Voltage Limit	V _{OUT} =V _{CE} =1.95V, Lx Switch ON	0.4	0.6	0.8	V
V _{CEH}	CE “H” Input Voltage	V _{OUT} =V _{CE} =set V _{OUT} ×0.96, Judgment is made by the Lx waveform	0.9			V
V _{CEL}	CE “L” Input Voltage	V _{OUT} =V _{CE} =set V _{OUT} ×0.96, Judgment is made by the Lx waveform			0.3	V
I _{CEH}	CE “H” Input Current	V _{OUT} =6.0V, V _{CE} =6.0V	-0.5	0.0	0.5	μA
I _{CEL}	CE “L” Input Current	V _{OUT} =6.0V, V _{CE} =0.0V	-0.5	0.0	0.5	μA
I _{DD1}	Supply Current1 *2	2.0V≤V _{OUT} ≤2.4V		25	50	μA
I _{DD1}	Supply Current1 *2	2.5V≤V _{OUT} ≤2.9V		30	55	μA

Symbol	Item	Conditions	Min.	Typ.	Max.	Unit
I _{DD1}	Supply Current1 *2	3.0V≤V _{OUT} ≤3.4V		35	60	μA
I _{DD1}	Supply Current1 *2	3.5V≤V _{OUT} ≤3.9V		40	65	μA
I _{DD1}	Supply Current1 *2	4.0V≤V _{OUT} ≤4.4V		45	75	μA
I _{DD1}	Supply Current1 *2	4.5V≤V _{OUT} ≤4.9V		50	80	μA
I _{DD1}	Supply Current1 *2	5.0V≤V _{OUT} ≤5.5V		60	90	μA
I _{LX}	Lx Switching Current	2.0V≤V _{OUT} ≤2.4V, V _{LX} =0.4V	80			mA
I _{LX}	Lx Switching Current	2.5V≤V _{OUT} ≤2.9V, V _{LX} =0.4V	100			mA
I _{LX}	Lx Switching Current	3.0V≤V _{OUT} ≤3.4V, V _{LX} =0.4V	120			mA
I _{LX}	Lx Switching Current	3.5V≤V _{OUT} ≤3.9V, V _{LX} =0.4V	140			mA
I _{LX}	Lx Switching Current	4.0V≤V _{OUT} ≤4.4V, V _{LX} =0.4V	160			mA
I _{LX}	Lx Switching Current	4.5V≤V _{OUT} ≤4.9V, V _{LX} =0.4V	180			mA
I _{LX}	Lx Switching Current	5.0V≤V _{OUT} ≤5.5V, V _{LX} =0.4V	200			mA

- *1) Condition: An Output load resistor R_L is connected between V_{OUT} and GND.
 Note that the resistor R_L has a resistance which makes an output current 1mA after step-up operation.
- *2) The Supply Current 1 (I_{DD1}) for IC itself is measured when the internal oscillator works continuously.
 If the oscillator works intermittently, the supply current becomes smaller than the value which is written on the above table.
 Measurement condition: V_{OUT}=V_{CE}=Setting Output Voltage ×0.96

• RN5RKxx2A

T_{opt}=25°C

Symbol	Item	Conditions	Min.	Typ.	Max.	Unit
V _{OUT}	Output Voltage	V _{IN} =set V _{OUT} ×0.6, I _{OUT} =1mA	×0.975		×1.025	V
V _{IN}	Input Voltage				8	V
ΔV _{OUT} /ΔT _{opt}	Output Voltage Temperature Coefficient	-40°C≤T _{opt} ≤85°C		±100		ppm/°C
V _{start}	Start-Up Voltage	V _{IN} =0V→2V*1		0.7	0.8	V
ΔV _{start} /ΔT _{opt}	Start-Up Voltage Temperature Coefficient	-40°C≤T _{opt} ≤85°C V _{IN} =0V→2V*1	-1.6			mV/°C
I _{DD2}	Supply Current2	V _{OUT} =V _{CE} =set V _{OUT} +0.5V		2	5	μA
I _{standby}	Standby Current	V _{OUT} =6V, V _{CE} =0V			0.5	μA
F _{osc}	Maximum Oscillator Frequency	V _{OUT} =V _{CE} =set V _{OUT} ×0.96	80	100	120	kHz
Δf _{osc} /ΔT _{opt}	Frequency Temperature Coefficient	-40°C≤T _{opt} ≤85°C		0.41		kHz/°C
Duty	Oscillator Duty Cycle	V _{OUT} =V _{CE} =set V _{OUT} ×0.96, ON (V _{EXT} “H” side)	70	77	85	%
V _{CEH}	CE “H” Input Voltage	V _{OUT} =V _{CE} =set V _{OUT} ×0.96, Judgment is made by the EXT waveform	0.9			V
V _{CEL}	CE “L” Input Voltage	V _{OUT} =V _{CE} =set V _{OUT} ×0.96 Judgment is made by the EXT waveform			0.3	V
I _{CEH}	CE “H” Input Current	V _{OUT} =6.0V, V _{CE} =6.0V	-0.5	0.0	0.5	μA
I _{CEL}	CE “L” Input Current	V _{OUT} =6.0V, V _{CE} =0.0V	-0.5	0.0	0.5	μA
I _{DD1}	Supply Current1	2.0V≤V _{OUT} ≤2.9V, EXT no load*2		20	40	μA
I _{DD1}	Supply Current1	3.0V≤V _{OUT} ≤3.9V, EXT no load*2		25	50	μA
I _{DD1}	Supply Current1	4.0V≤V _{OUT} ≤4.9V, EXT no load*2		30	60	μA
I _{DD1}	Supply Current1	5.0V≤V _{OUT} ≤5.5V, EXT no load*2		35	70	μA
I _{EXTH}	EXT “H” Output Voltage	2.0V≤V _{OUT} ≤2.9V, V _{EXT} =V _{OUT} -0.4V			-1.0	mA
I _{EXTH}	EXT “H” Output Voltage	3.0V≤V _{OUT} ≤3.9V, V _{EXT} =V _{OUT} -0.4V			-1.5	mA

Symbol	Item	Conditions	Min.	Typ.	Max.	Unit
I_{EXTH}	EXT “H” Output Voltage	$4.0V \leq V_{OUT} \leq 5.5V$, $V_{EXT} = V_{OUT} - 0.4V$			-2.0	mA
I_{EXTH}	EXT “L” Output Voltage	$2.0V \leq V_{OUT} \leq 2.9V$, $V_{EXT} = 0.4V$	1.0			mA
I_{EXTH}	EXT “L” Output Voltage	$3.0V \leq V_{OUT} \leq 3.9V$, $V_{EXT} = 0.4V$	1.5			mA
I_{EXTH}	EXT “L” Output Voltage	$4.0V \leq V_{OUT} \leq 5.5V$, $V_{EXT} = 0.4V$	2.0			mA

- *1) Condition: An Output load resistor R_L is connected between V_{OUT} and GND.
Note that the resistor R_L has a resistance which makes an output current 1mA after step-up operation.
- *2) The Supply Current 1 (I_{DD1}) for IC itself is measured when the internal oscillator works continuously.
If the oscillator works intermittently, the supply current becomes smaller than the value which is written on the above table. Measurement condition: $V_{OUT} = V_{CE} = \text{Setting Output Voltage} \times 0.96$

TEST CIRCUITS

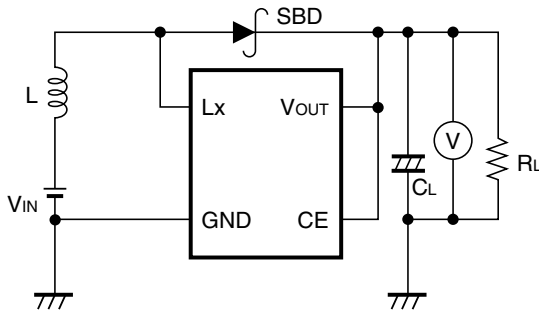

Test Circuit 1

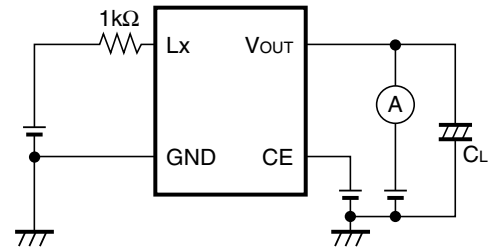

Test Circuit 2

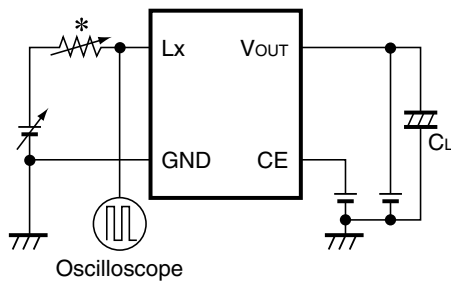

Test Circuit 3

*) When V_{Lxlim} and I_{Lx} are measured, the 5Ω resistor is used. Otherwise $1k\Omega$ is used.

Components Inductor (L) : $100\mu H$, $220\mu H$ (Sumida Electric Co., Ltd; CD-54)

Diode (SBD) : MA721 (Matsushita Electronics Corporation; Schottky Type)

Capacitor (C_L) : $47\mu F$ (Tantalum Type)

Using these test circuits characteristics data has been obtained as shown on the following pages.

Test Circuit 1 : Typical Characteristics (1)-(7)

Test Circuit 2 : Typical Characteristics (9)-(11)

Test Circuit 3 : Typical Characteristics (8), (12)-(16)

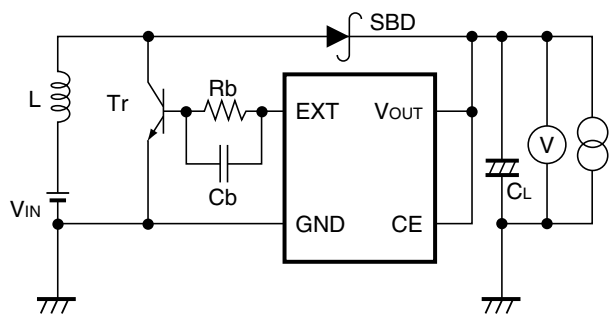

Test Circuit 1

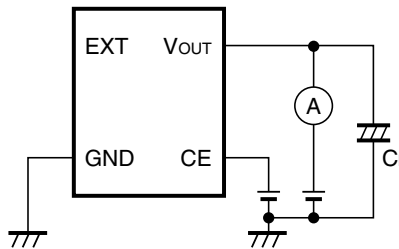

Test Circuit 2

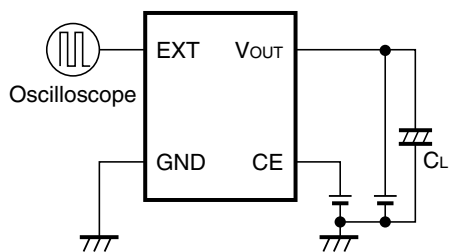

Test Circuit 3

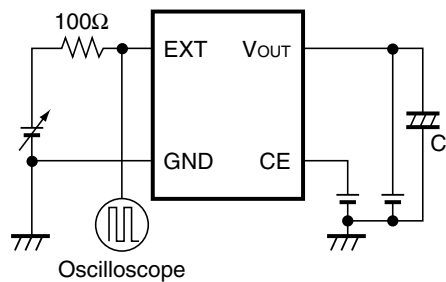

Test Circuit 4

- Components Inductor (L) : 27 μ H (Sumida Electric Co., Ltd; CD-104)
- Diode (SBD) : RB111C (Rohm Co., Ltd; Schottky Type)
- Capacitor (CL) : 47 μ F \times 2(Tantalum Type)
- Transistor (Tr) : 2SD1628G
- Base Resistor (Rb) : 300 Ω Base Capacitor (Cb): 0.01 μ F

The typical characteristics were obtained with using these test circuits.

- Test Circuit 1 : Typical Characteristics (1)-(5)
- Test Circuit 2 : Typical Characteristics (8)-(10)
- Test Circuit 3 : Typical Characteristics (11)-(14)
- Test Circuit 4 : Typical Characteristics (6), (7)

TYPICAL CHARACTERISTICS

- RN5RKxx1A/B

1) Output Voltage vs. Output Current (Topt=25°C)

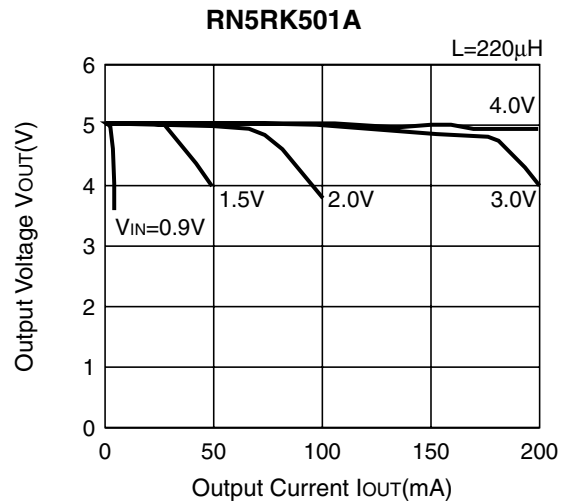
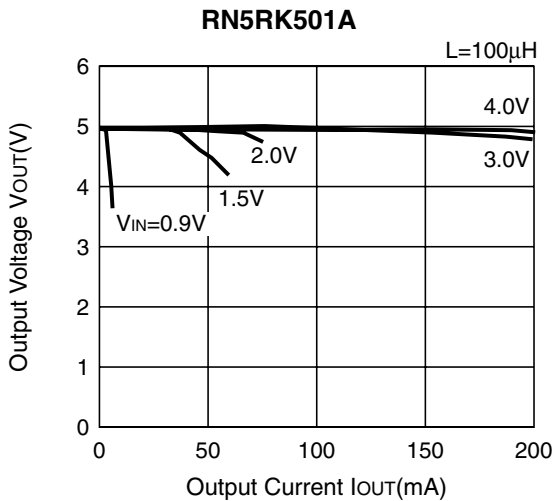
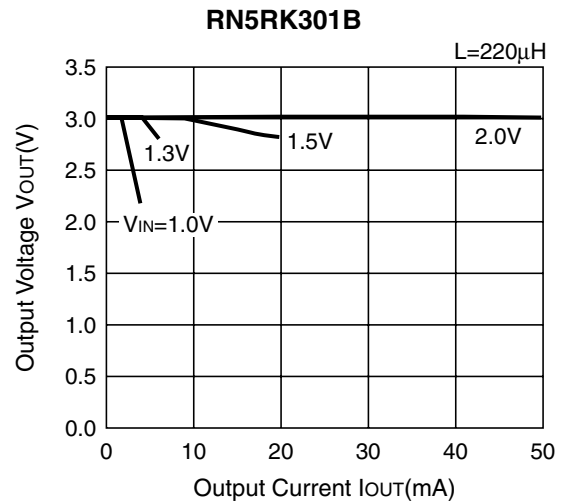
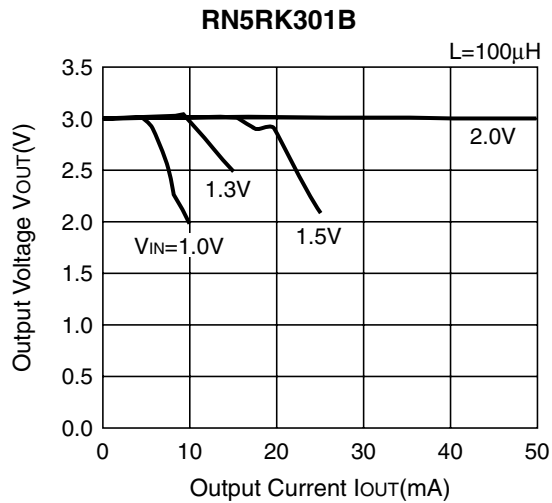
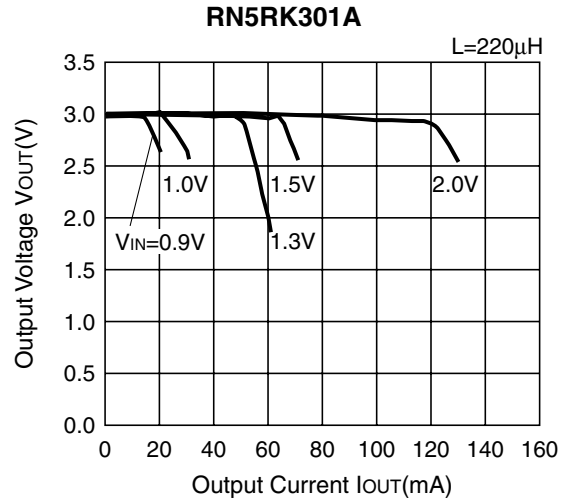
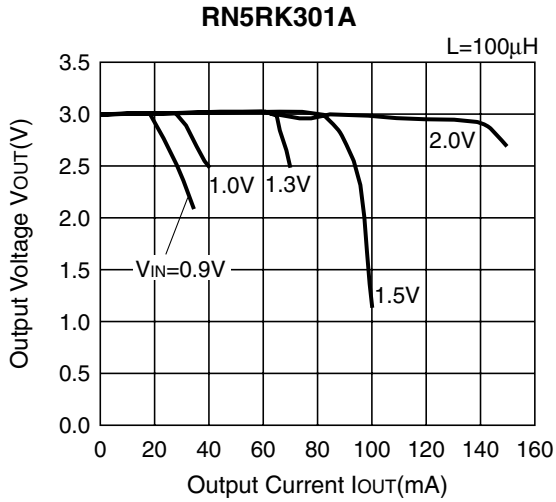

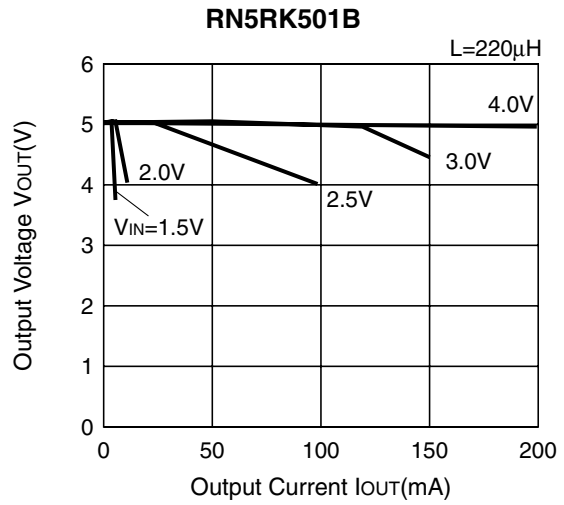
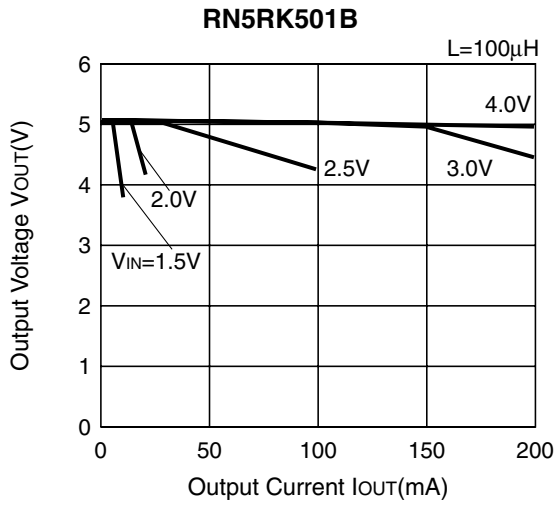

2) Efficiency vs. Output Current ($T_{opt}=25^{\circ}C$)

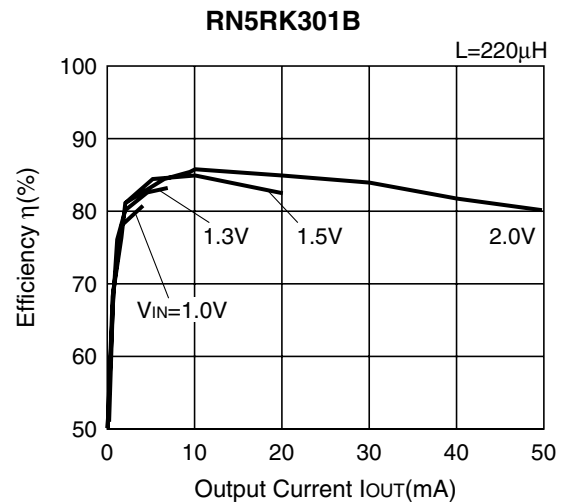
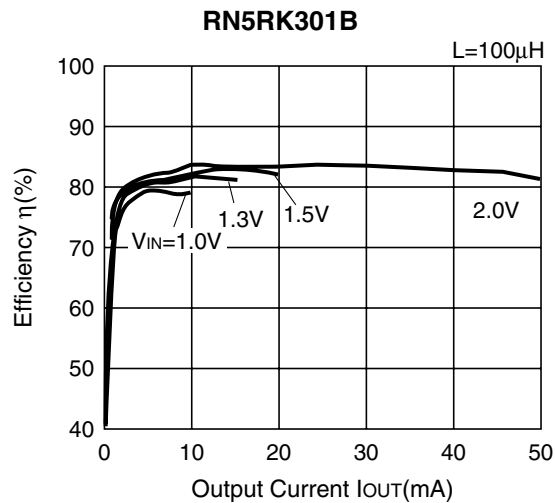
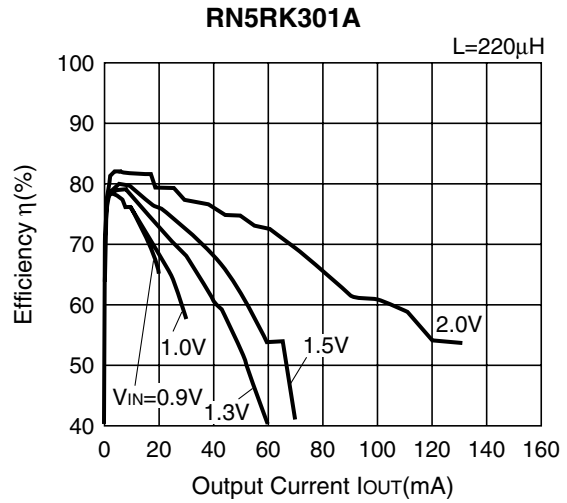
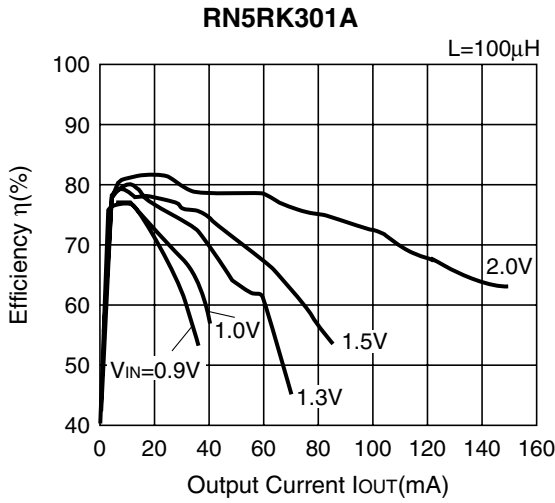

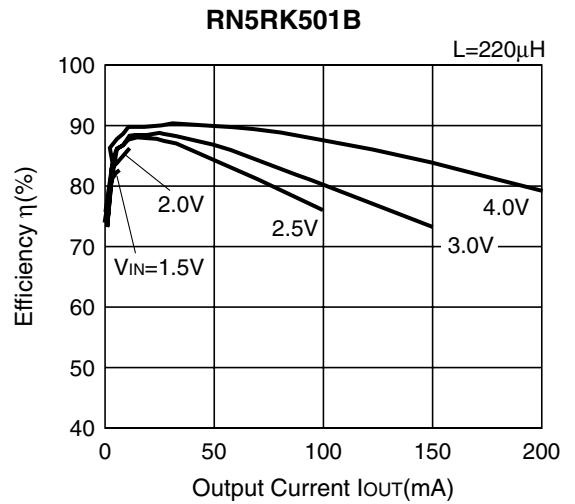
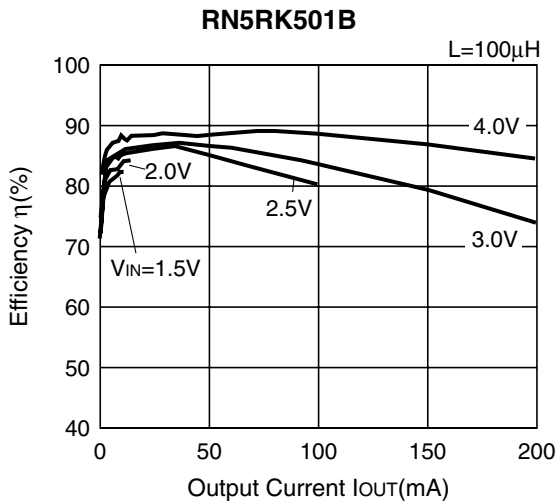
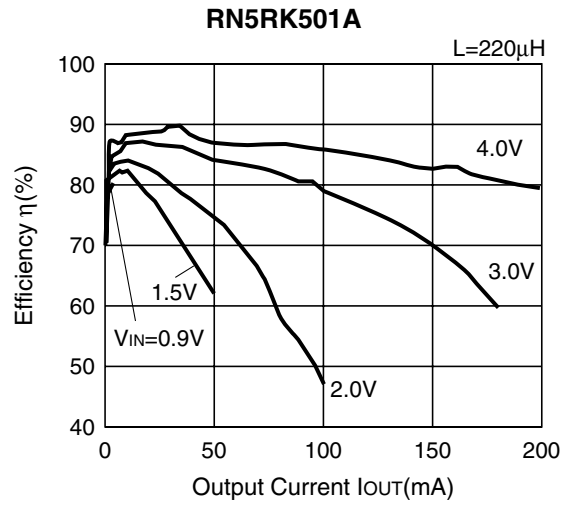
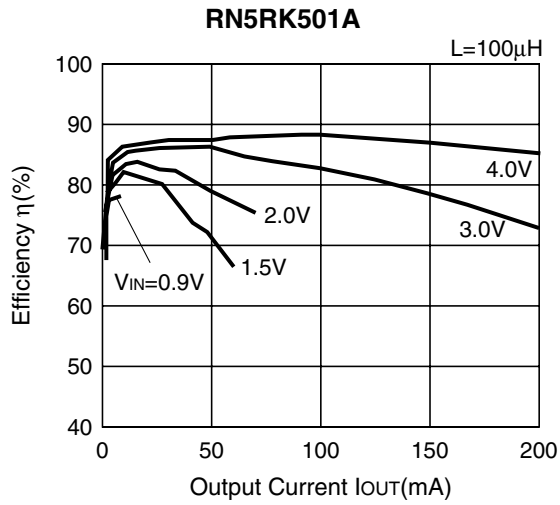

3) Ripple Voltage vs. Output Current (Topt=25°C)

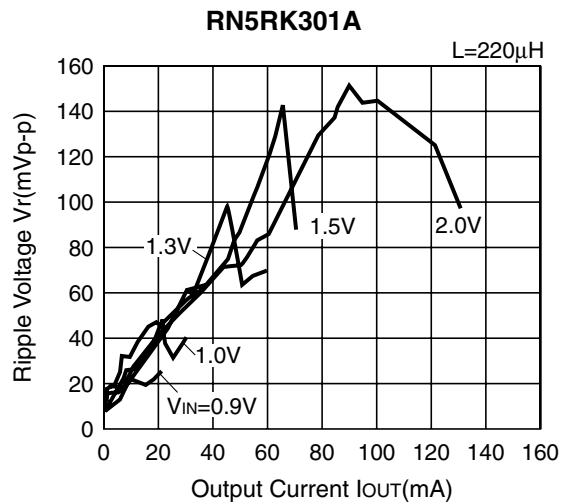
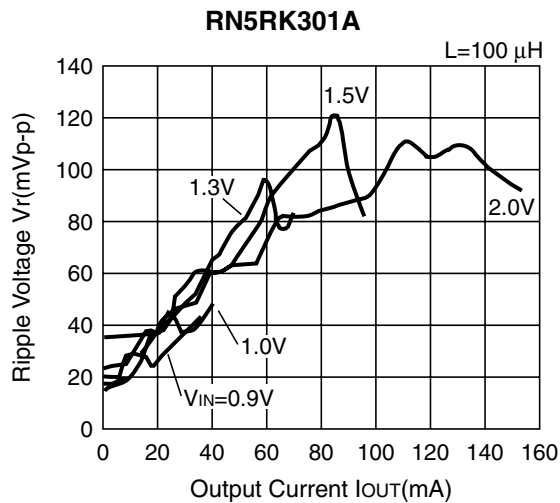

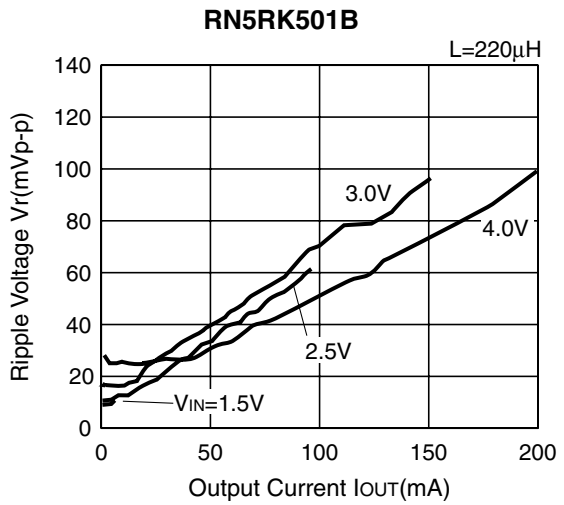
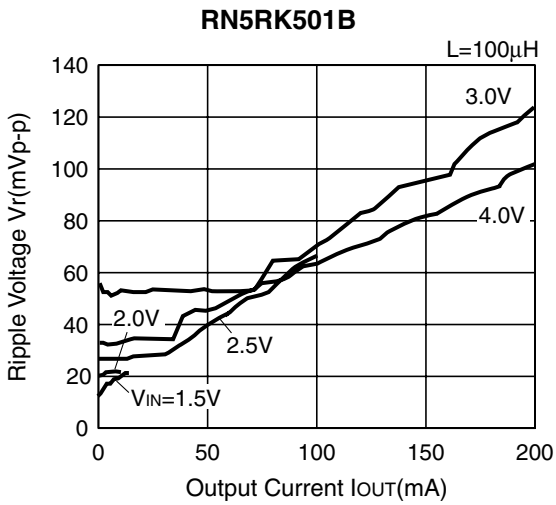
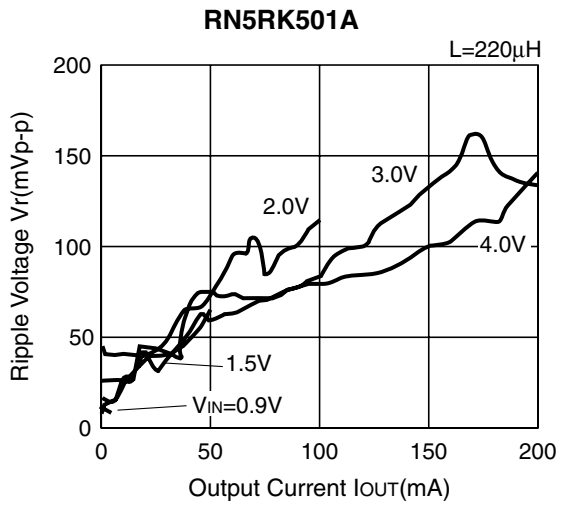
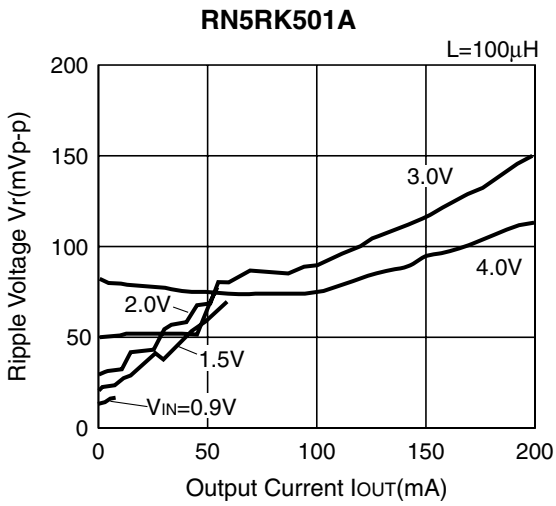
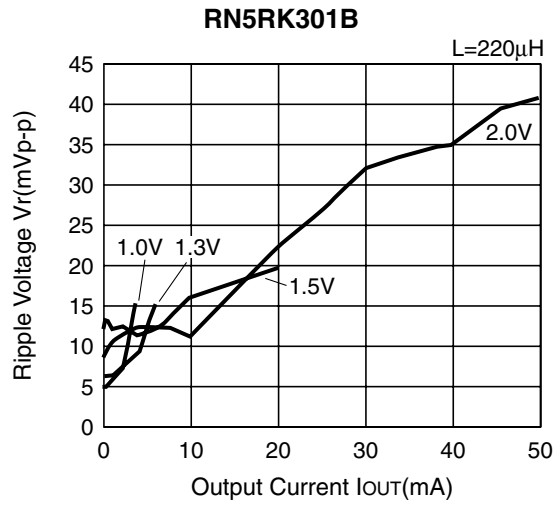
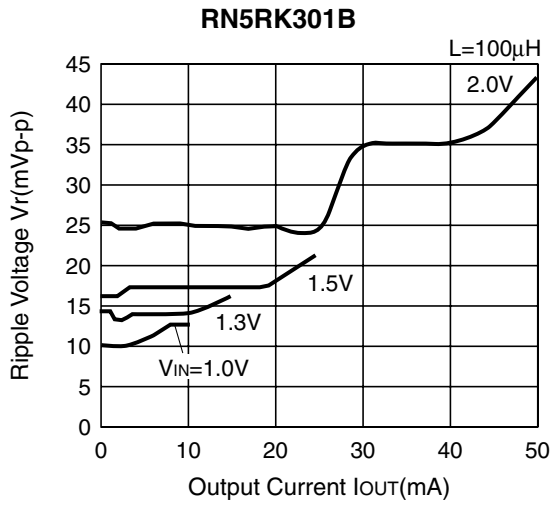

4) Start-up/Hold-on Voltage vs. Output Current (Topt=25°C)

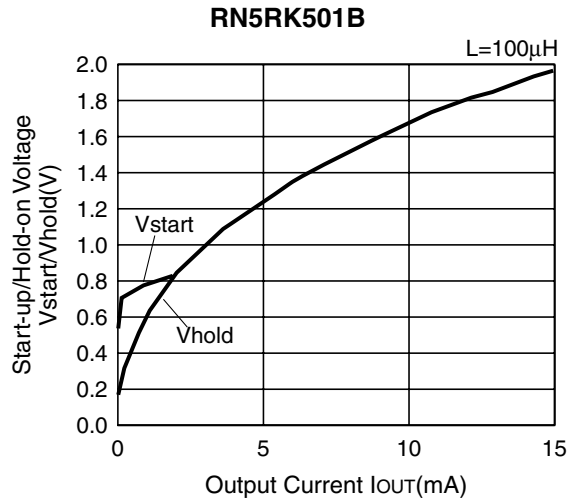
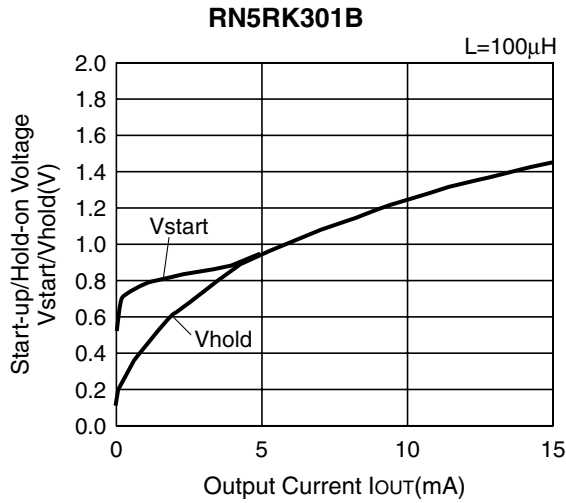
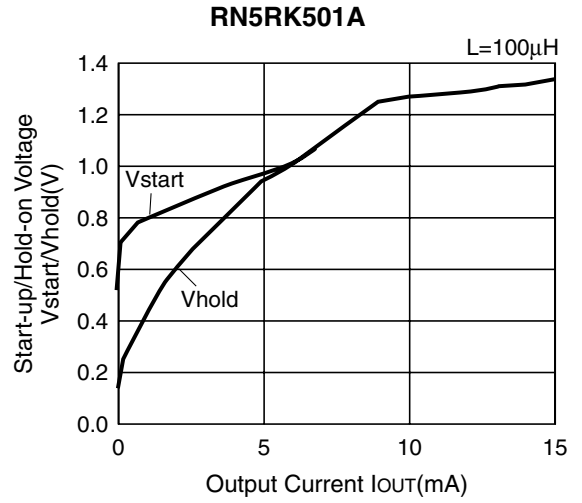
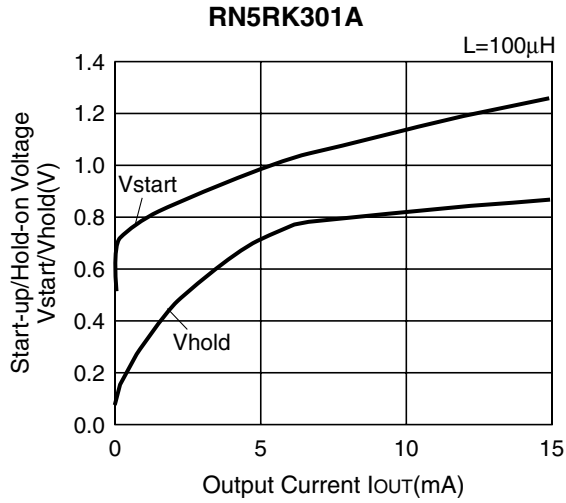

5) Output Voltage vs. Temperature

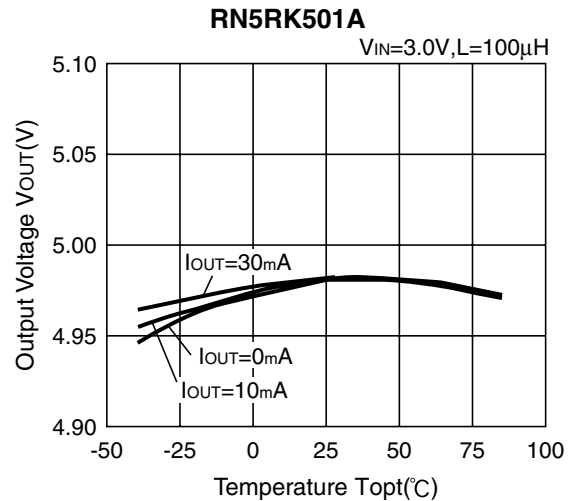
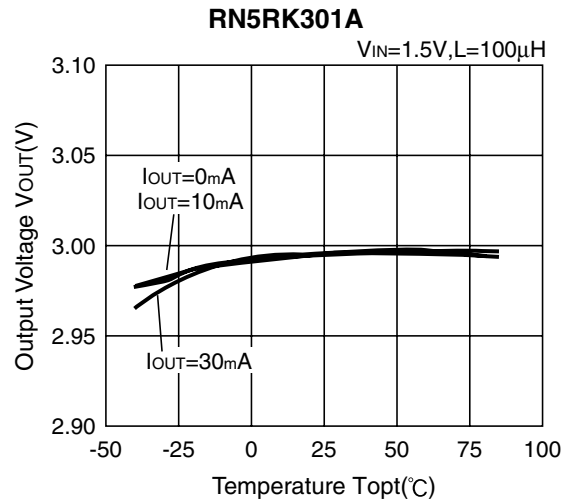

6) Start-up Voltage vs. Temperature

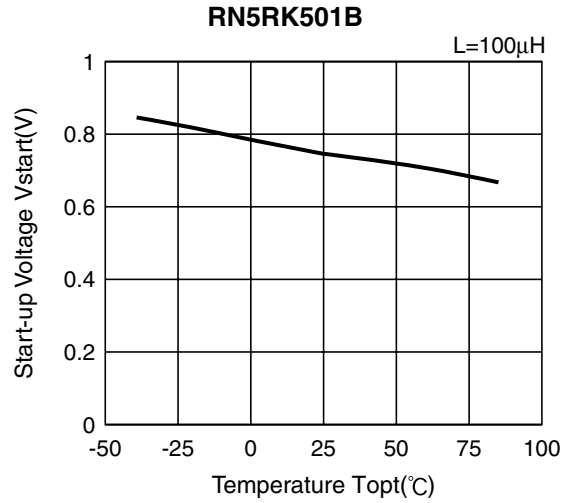
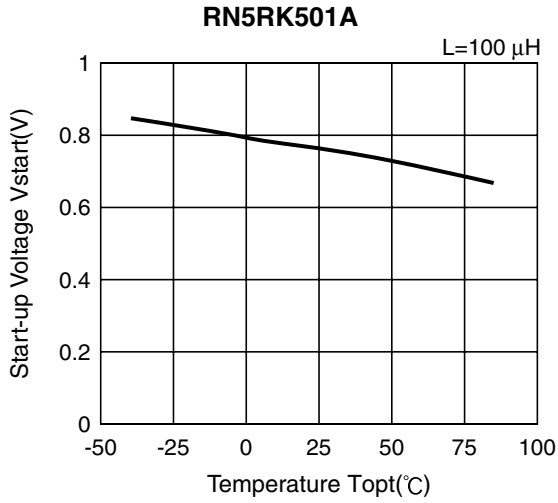

7) Hold-on Voltage vs. Temperature

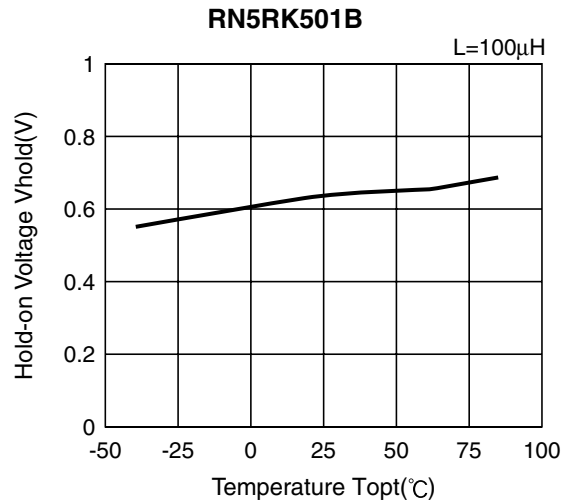
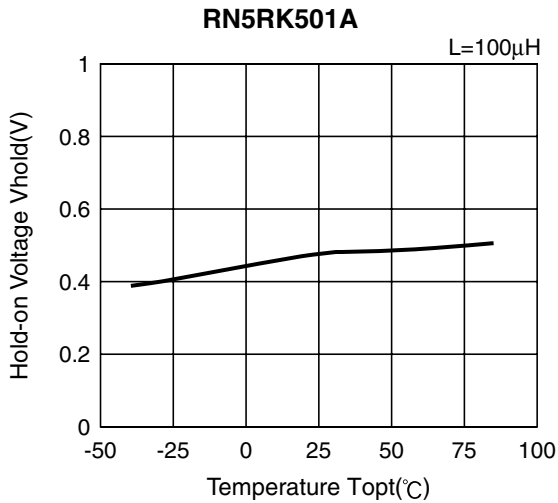

8) Lx Switching Current vs. Temperature

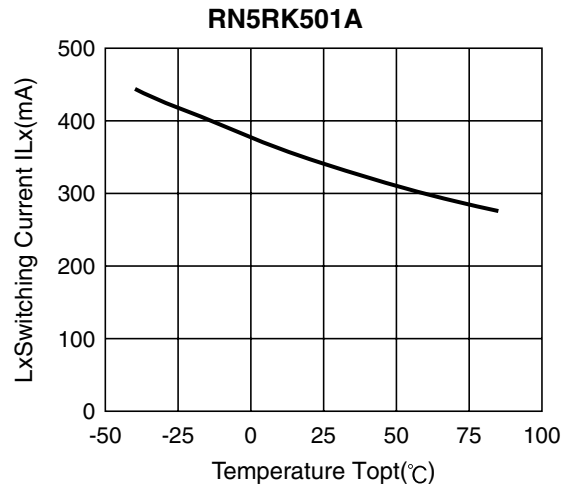
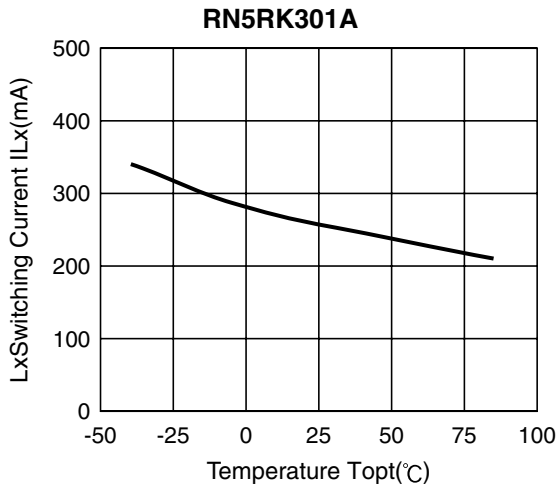

9) Supply Current 1 vs. Temperature

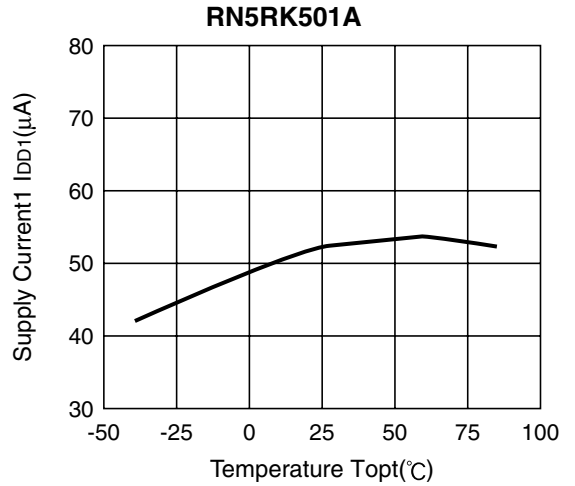
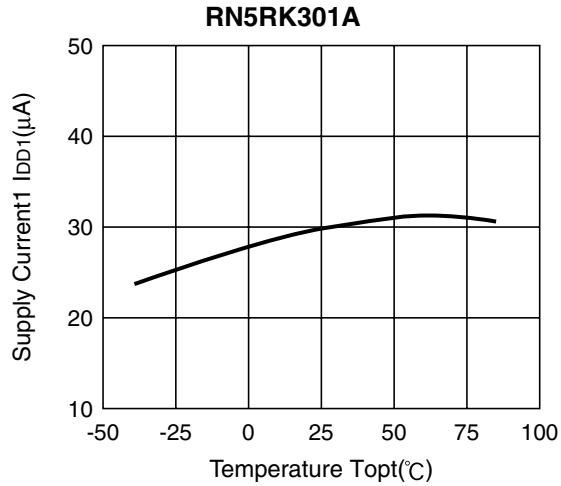

10) Supply Current 2 vs. Temperature

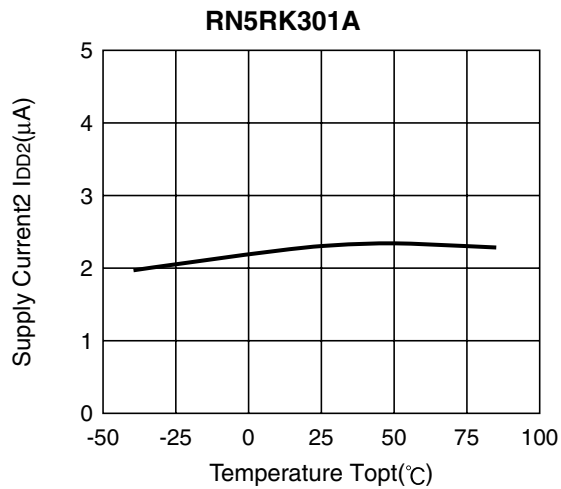

11) Standby Current 3 vs. Temperature

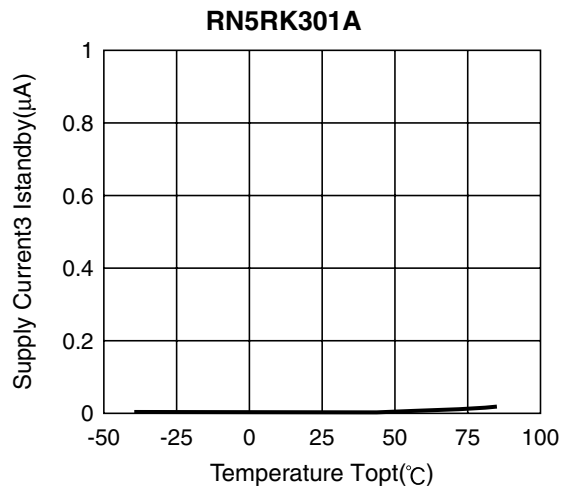

12) Oscillator Duty Cycle vs. Temperature

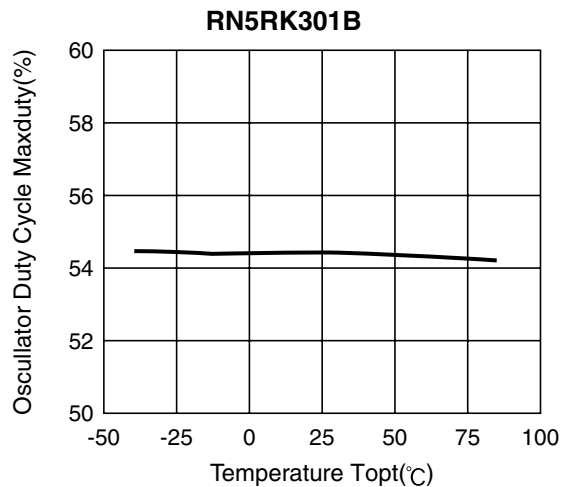
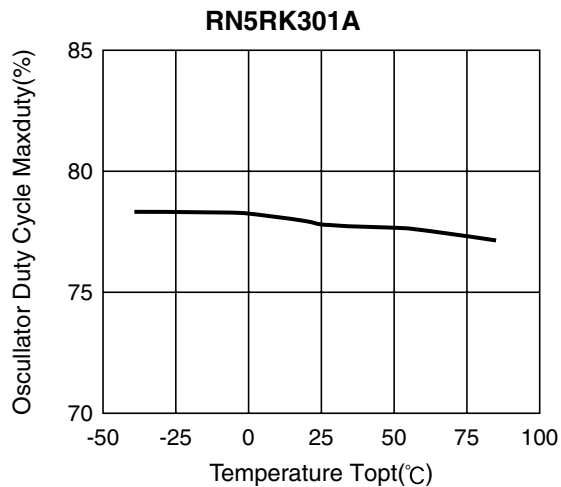

13) CE "H" Input Voltage vs. Temperature

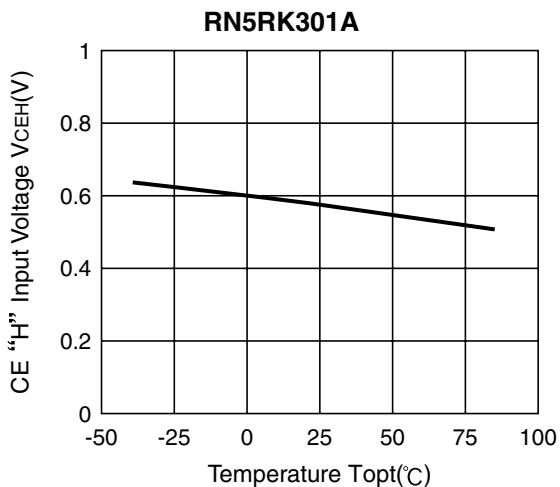

14) CE "L" Input Voltage vs. Temperature

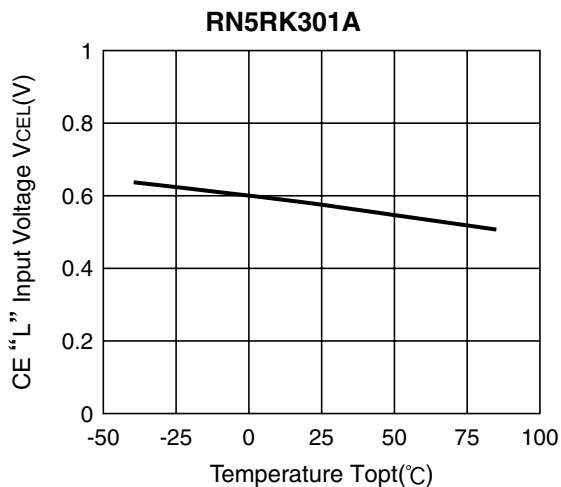

15) Maximum Oscillator Frequency vs. Temperature

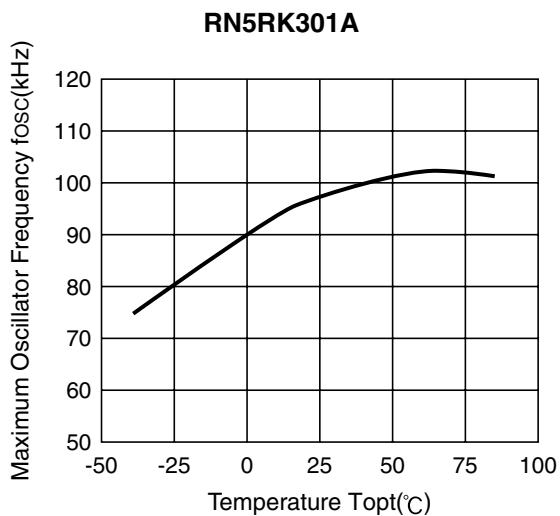

16) VLX Voltage Limit vs. Temperature

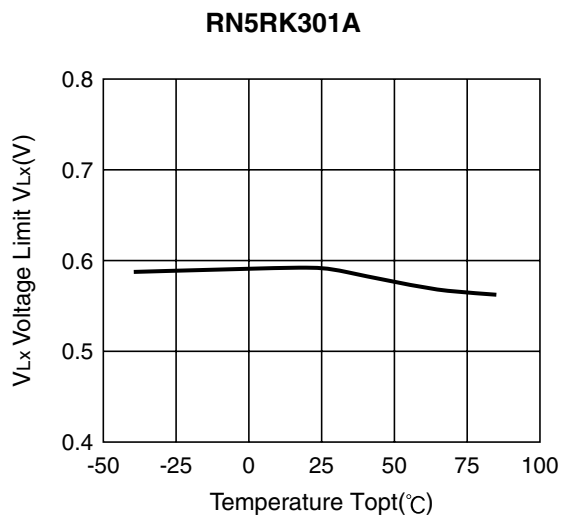

• RN5RKxx2A

1) Output Voltage vs. Output Current (Topt=25°C)

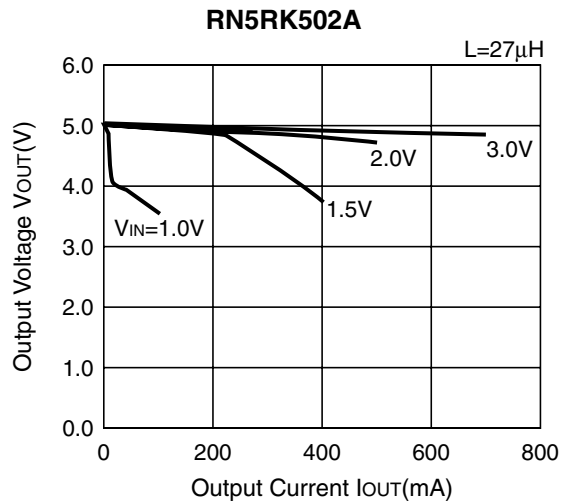
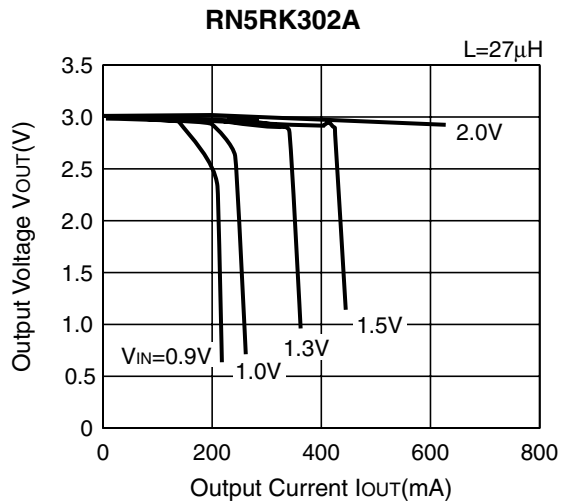

2) Efficiency vs. Output Current (Topt=25°C)

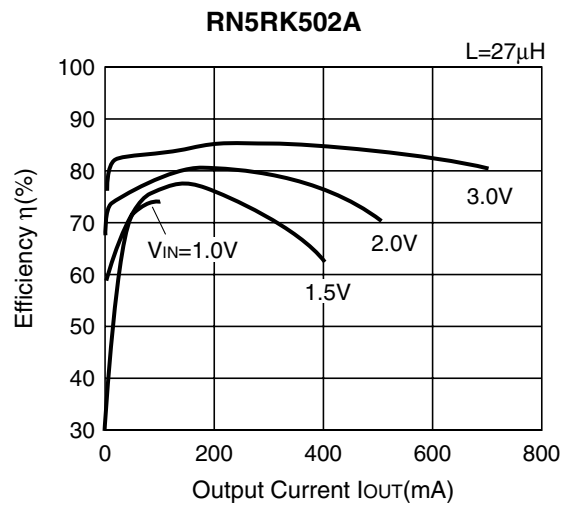
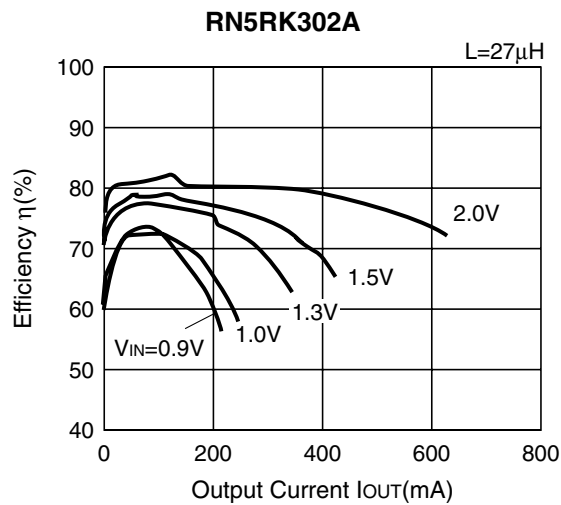

3) Ripple Voltage vs. Output Current (Topt=25°C)

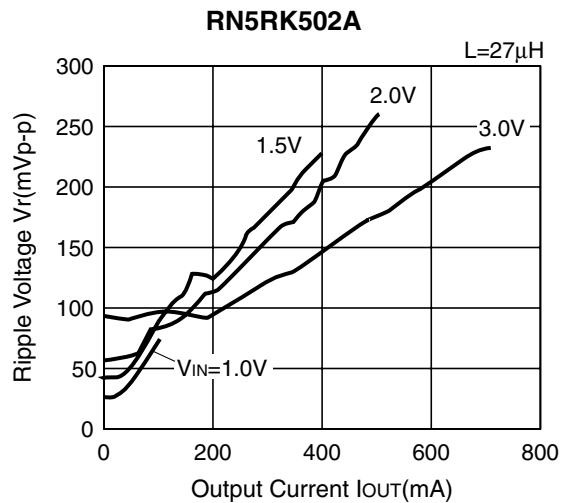
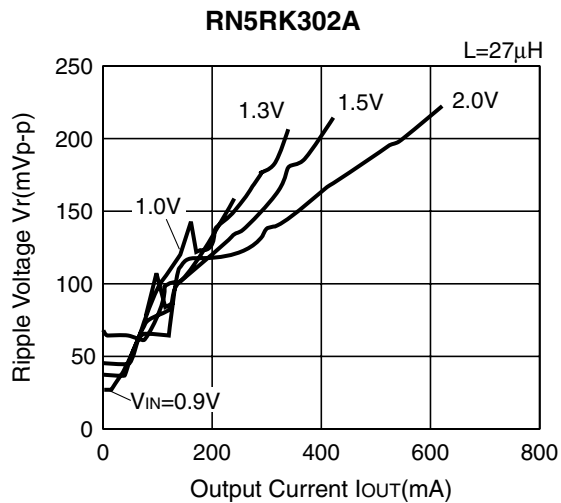

4) Start-up/Hold-on Voltage vs. Output Current (Topt=25°C)

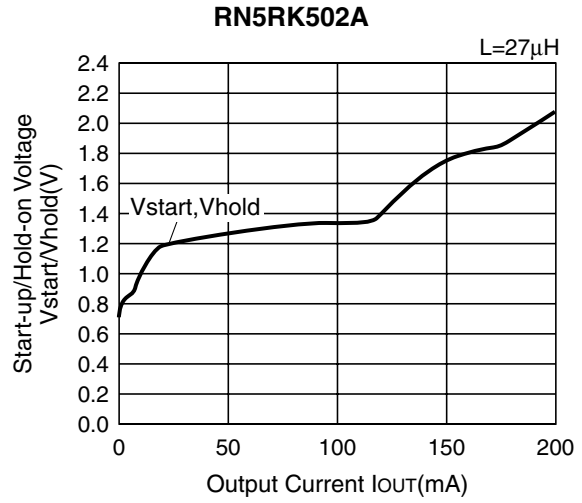
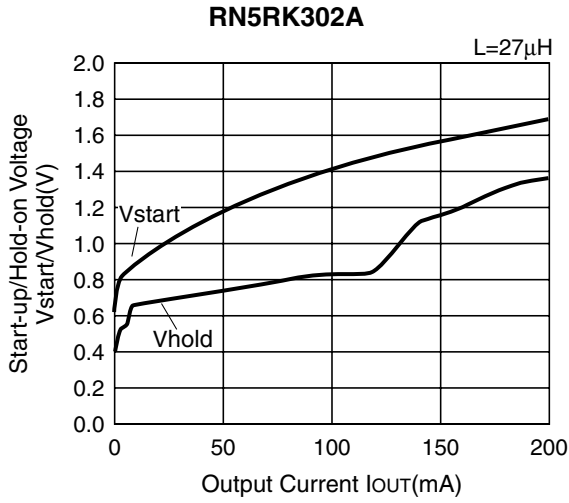

5) Output Voltage vs. Temperature

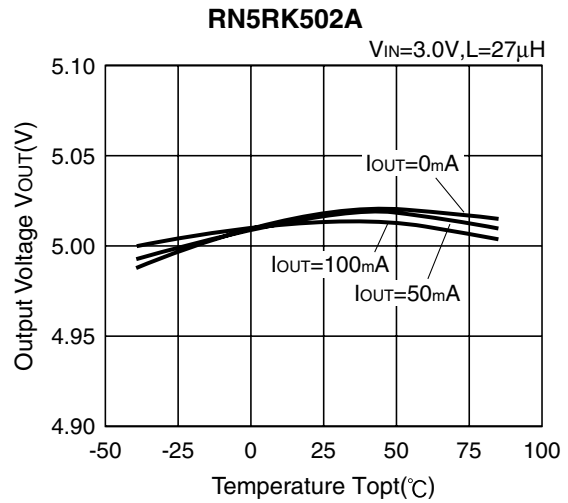
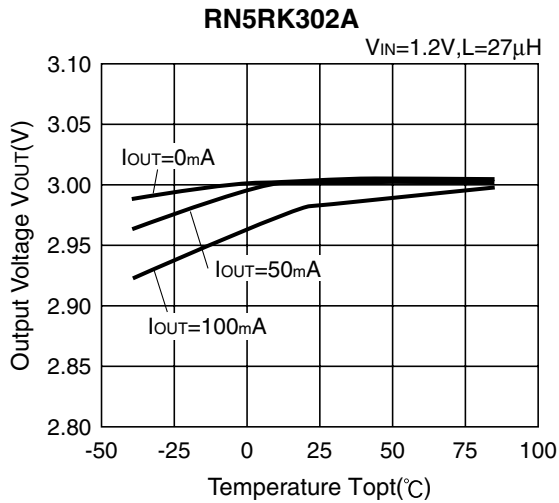

6) EXT "H" Output Current vs. Temperature

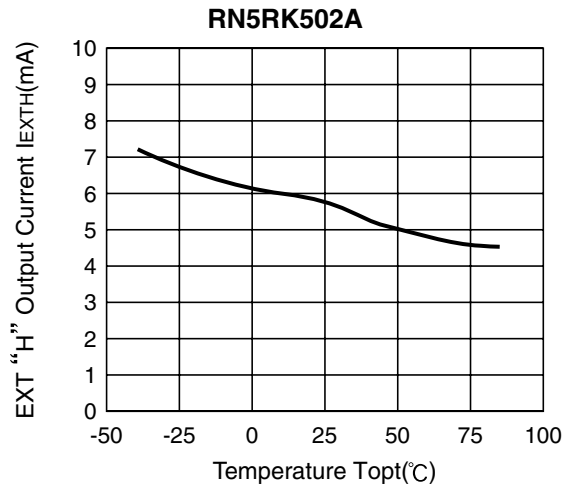
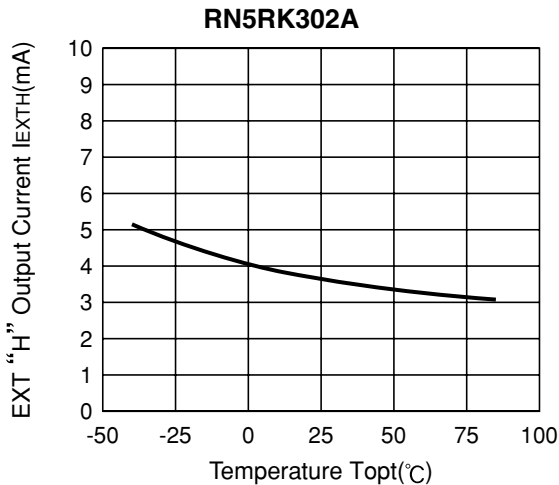

7) EXT "L" Output Current vs. Temperature

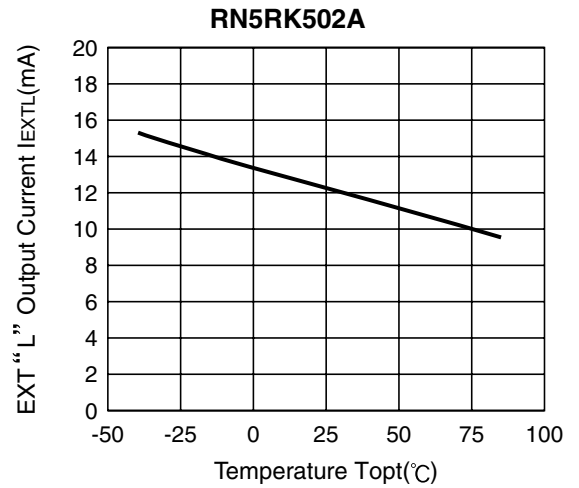
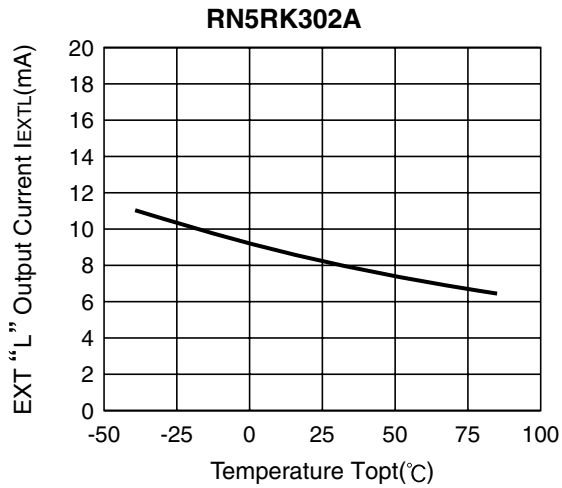

8) Supply Current 1 vs. Temperature

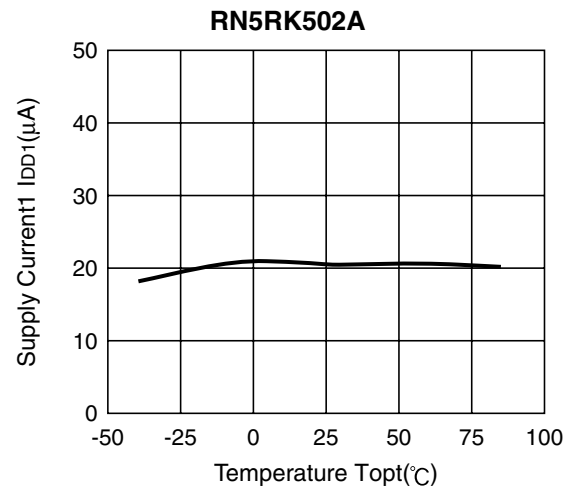
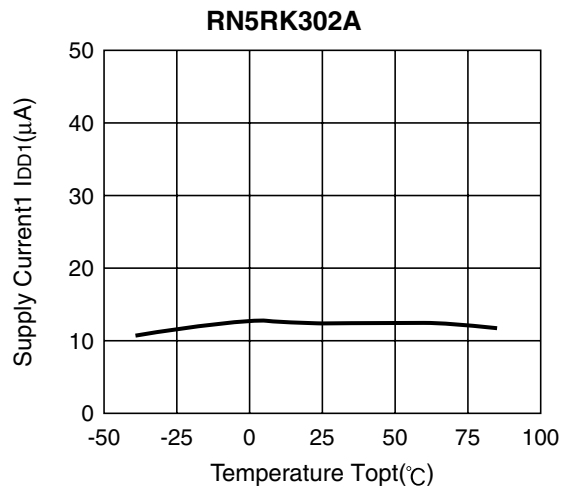

9) Supply Current 2 vs. Temperature

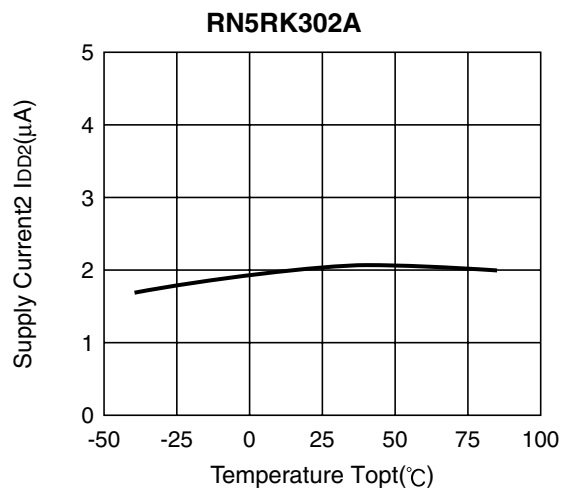

10) Standby Current vs. Temperature

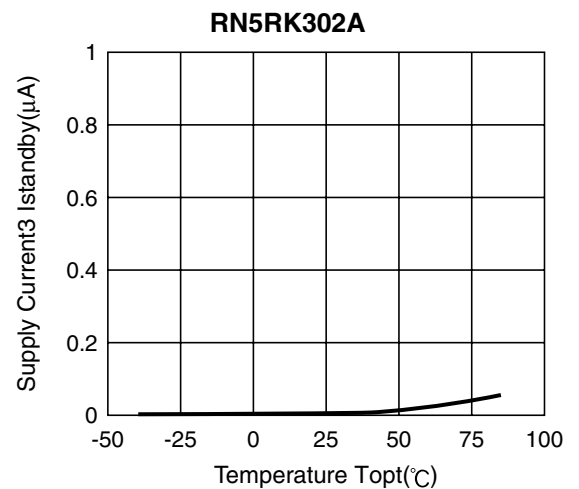

11) Oscillator Duty Cycle vs. Temperature

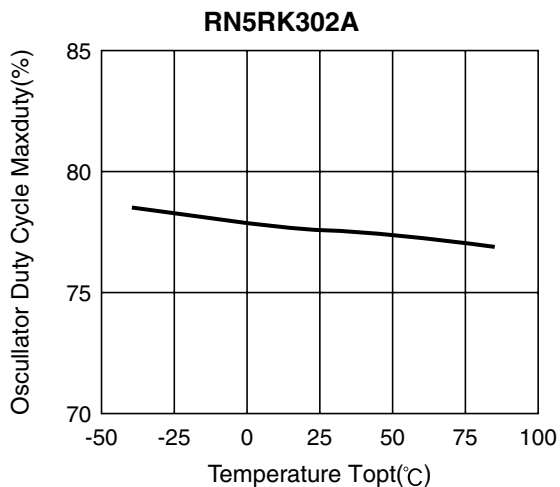

12) Maximum Oscillator Frequency vs. Temperature

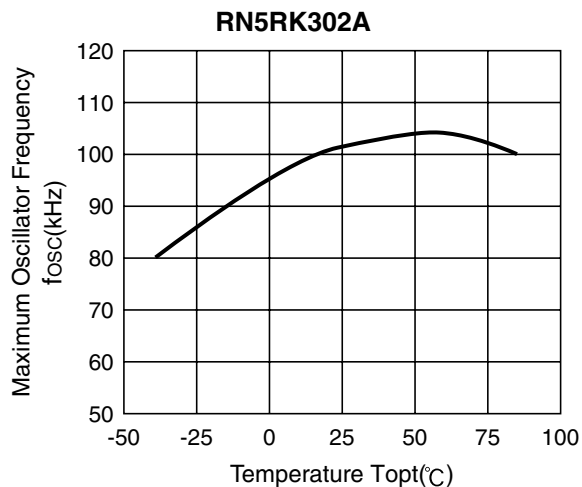

13) CE "H" Input Voltage vs. Temperature

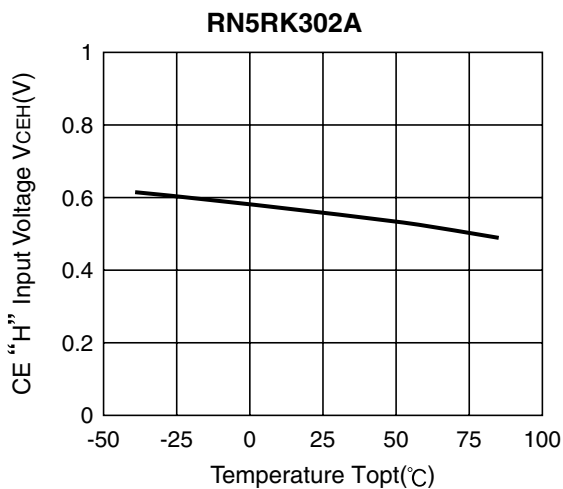

14) CE "L" Input Voltage vs. Temperature

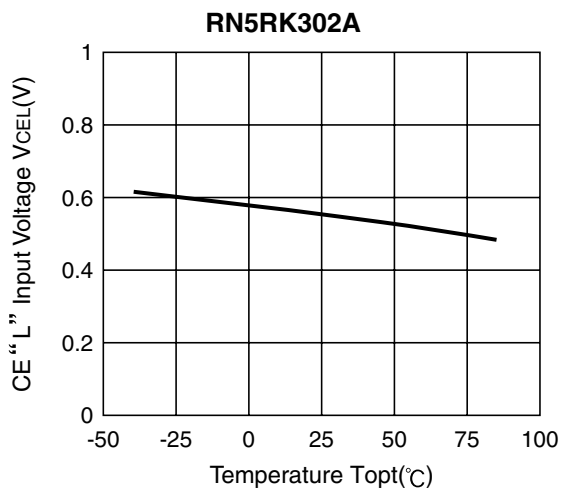

Компания «Океан Электроники» предлагает заключение долгосрочных отношений при поставках импортных электронных компонентов на взаимовыгодных условиях!

Наши преимущества:

- Поставка оригинальных импортных электронных компонентов напрямую с производств Америки, Европы и Азии, а так же с крупнейших складов мира;
- Широкая линейка поставок активных и пассивных импортных электронных компонентов (более 30 млн. наименований);
- Поставка сложных, дефицитных, либо снятых с производства позиций;
- Оперативные сроки поставки под заказ (от 5 рабочих дней);
- Экспресс доставка в любую точку России;
- Помощь Конструкторского Отдела и консультации квалифицированных инженеров;
- Техническая поддержка проекта, помощь в подборе аналогов, поставка прототипов;
- Поставка электронных компонентов под контролем ВП;
- Система менеджмента качества сертифицирована по Международному стандарту ISO 9001;
- При необходимости вся продукция военного и аэрокосмического назначения проходит испытания и сертификацию в лаборатории (по согласованию с заказчиком);
- Поставка специализированных компонентов военного и аэрокосмического уровня качества (Xilinx, Altera, Analog Devices, Intersil, Interpoint, Microsemi, Actel, Aeroflex, Peregrine, VPT, Syfer, Eurofarad, Texas Instruments, MS Kennedy, Miteq, Cobham, E2V, MA-COM, Hittite, Mini-Circuits, General Dynamics и др.);

Компания «Океан Электроники» является официальным дистрибьютором и эксклюзивным представителем в России одного из крупнейших производителей разъемов военного и аэрокосмического назначения «JONHON», а так же официальным дистрибьютором и эксклюзивным представителем в России производителя высокотехнологичных и надежных решений для передачи СВЧ сигналов «FORSTAR».



JONHON

«JONHON» (основан в 1970 г.)

Разъемы специального, военного и аэрокосмического назначения:

(Применяются в военной, авиационной, аэрокосмической, морской, железнодорожной, горно- и нефтедобывающей отраслях промышленности)

«FORSTAR» (основан в 1998 г.)

ВЧ соединители, коаксиальные кабели, кабельные сборки и микроволновые компоненты:

(Применяются в телекоммуникациях гражданского и специального назначения, в средствах связи, РЛС, а так же военной, авиационной и аэрокосмической отраслях промышленности).



Телефон: 8 (812) 309-75-97 (многоканальный)

Факс: 8 (812) 320-03-32

Электронная почта: ocean@oceanchips.ru

Web: <http://oceanchips.ru/>

Адрес: 198099, г. Санкт-Петербург, ул. Калинина, д. 2, корп. 4, лит. А