



### Applications

- Telecommunications
- Data communications
- Wireless communications
- Servers

### Benefits

- High efficiency – no heat sink required
- Higher current capability at elevated temperatures than most competitors' 20 A quarter-bricks
- Extremely small footprint: 0.896" x 2.30" (2.06 in<sup>2</sup>), 38% smaller than conventional quarter-bricks

### Description

The new high temperature SQE48-Series of dc-dc converter provides a high efficiency single output in a physical package that is only 62% the size of the industry-standard quarter-brick. Specifically designed for operation in systems that have limited airflow and increased ambient temperatures, the SQE48-Series of converters utilizes the same pinout and functionality of the industry-standard quarter-bricks.

The SQE48-Series of converters provides thermal performance in high temperature environments that exceeds most competitors' 20 A quarter-bricks. This performance is accomplished through the use of patented/patent-pending circuits, packaging, and processing techniques to achieve ultra-high efficiency, excellent thermal management, and a low-body profile.

Low-body profile and the preclusion of heat sinks minimize airflow shadowing, thus enhancing cooling for downstream devices. The use of 100% automation for assembly, coupled with advanced electronic circuits, and thermal design, results in a product with extremely high reliability.

The SQE48T20050 operates over an input voltage range of 36 to 75 VDC, and provides an output current up to 20 A with a standard output voltage of 5.0 VDC. The output can be trimmed from –20% to +10% of the nominal output voltage, thus providing outstanding design flexibility.

With standard pinout and trim equations, the SQE48 converters are perfect drop-in replacements for the competing quarter-brick designs. Inclusion of this converter in new designs can result in significant board space and cost savings. The designer can expect reliability improvement over other available converters because of the SQE48-Series' optimized thermal efficiency.

### Features

- RoHS lead free solder and lead solder exempted products are available
- Delivers up to 20 A
- Industry-standard quarter-brick pinout
- On-board input differential LC-filter
- Start-up into pre-biased load
- No minimum load required
- Weight: 0.72 oz [20.6 g]
- Meets Basic Insulation requirements of EN60950
- Withstands 100 V input transient for 100 ms
- Fixed-frequency operation
- Fully protected
- Latching and non-latching protection available
- Positive or negative logic ON/OFF option
- Remote output sense
- Output voltage trim range: +10%/–20% with industry-standard trim equations
- High reliability: MTBF = 13.19 million hours, calculated per Telcordia TR-332, Method I Case 1
- UL60950 recognized in US and Canada and DEMKO certified per IEC/EN60950
- Designed to meet Class B conducted emissions per FCC and EN55022 when used with external filter
- All materials meet UL94, V-0 flammability rating

# SQE48T20050 DC-DC Converter Data Sheet

## 36-75 VDC Input; 5.0 VDC @ 20 A Output



### Electrical Specifications

Conditions:  $T_A = 25\text{ }^\circ\text{C}$ , Airflow=300 LFM (1.5 m/s),  $V_{in} = 48\text{ VDC}$ , unless otherwise specified.

Parameter	Notes	Min	Typ	Max	Units
<b>Absolute Maximum Ratings</b>					
Input Voltage	Continuous	0		80	VDC
Operating Ambient Temperature		-40		85	$^\circ\text{C}$
Storage Temperature		-55		125	$^\circ\text{C}$
<b>Input Characteristics</b>					
Operating Input Voltage Range		36	48	75	VDC
Input Under Voltage Lockout	Non-latching				
Turn-on Threshold		33	34	35	VDC
Turn-off Threshold		31	32	33	VDC
Input Voltage Transient	100 ms			100	VDC
<b>Isolation Characteristics</b>					
I/O Isolation		2250			VDC
	See note *	1500			VDC
Isolation Capacitance			190		pF
	See note *		1200		pF
Isolation Resistance		10			M $\Omega$
<b>Feature Characteristics</b>					
Switching Frequency			460		kHz
Output Voltage Trim Range <sup>1</sup>	Industry-std. equations	-20		+10	%
Remote Sense Compensation <sup>1</sup>	Percent of $V_{OUT(NOM)}$			+10	%
Output Overvoltage Protection	Latching or Non-latching	117	122	127	%
	Non-latching*	120	125	130	%
Overtemperature Shutdown (PCB)	Non-latching		125		$^\circ\text{C}$
Peak Back-drive Output Current (Sinking current from external source) during startup into pre-biased output	Peak amplitude		1		ADC
	Peak duration		50		$\mu\text{s}$
Back-drive Output Current (Sinking Current from external source)	Converter Off; external voltage 5 VDC		10	30	mADC
Auto-Restart Period (For non-latching option)	Applies to all protection features		200		ms
Turn-On Time			4		ms
<b>ON/OFF Control (Positive Logic)</b>					
Converter Off (logic low)		-20		0.8	VDC
Converter On (logic high)		2.4		20	VDC
<b>ON/OFF Control (Negative Logic)</b>					
Converter Off (logic high)		2.4		20	VDC
Converter On (logic low)		-20		0.8	VDC

Additional Notes:

<sup>1</sup>  $V_{out}$  can be increased up to 10% via the sense leads or up to 10% via the trim function. However, the total output voltage trim from all sources should not exceed 10% of  $V_{OUT(NOM)}$ , in order to ensure specified operation of overvoltage protection circuitry.

\* For models with the special feature "K".

# SQE48T20050 DC-DC Converter Data Sheet

## 36-75 VDC Input; 5.0 VDC @ 20 A Output



### Electrical Specifications (continued)

Conditions:  $T_A = 25^\circ\text{C}$ , Airflow = 300 LFM (1.5 m/s),  $V_{in} = 48\text{ VDC}$ , unless otherwise specified.

Parameter	Notes	Min	Typ	Max	Units
<b>Input Characteristics</b>					
Maximum Input Current	20 ADC, 5.0 VDC Out @ 36 VDC In			3.1	ADC
Input Stand-by Current	$V_{in} = 48\text{ V}$ , converter disabled		2		mADC
Input No Load Current (0 load on the output)	$V_{in} = 48\text{ V}$ , converter enabled		40		mADC
Input Reflected-Ripple Current	20 MHz bandwidth		8		$\text{mA}_{\text{PK-PK}}$
Input Voltage Ripple Rejection	120Hz		75		dB
<b>Output Characteristics</b>					
Output Voltage Set Point (no load)		4.950	5.000	5.050	VDC
Output Regulation					
Over Line			$\pm 2$	$\pm 5$	mV
Over Load			$\pm 2$	$\pm 5$	mV
Output Voltage Range	Over line, load and temperature <sup>2</sup>	4.925		5.075	VDC
Output Ripple and Noise - 20MHz bandwidth	Full load + 10 $\mu\text{F}$ tantalum + 1 $\mu\text{F}$ ceramic		50	100	$\text{mV}_{\text{PK-PK}}$
External Load Capacitance	Plus full load (resistive)			10,000	$\mu\text{F}$
Output Current Range		0		20	ADC
Current Limit Inception	Non-latching	22	25	29	ADC
Peak Short-Circuit Current	For non-latching option, Short = 10 m $\Omega$		25		A
RMS Short-Circuit Current	For non-latching option		4	8	Arms
<b>Dynamic Response</b>					
Load Change 50%-100%-50%, di/dt = 0.1 A/ $\mu\text{s}$	$C_o = 1\ \mu\text{F}$ ceramic		40		mV
	$C_o = 470\ \mu\text{F}$ POS + 1 $\mu\text{F}$ ceramic		180		mV
Settling Time to 1%			20		$\mu\text{s}$
Load Change 50%-75%-50%, di/dt = 2.5 A/ $\mu\text{s}$	$C_o = 2 \times 100\ \mu\text{F}$ TA + 1 $\mu\text{F}$ ceramic		100*		mV
<b>Efficiency</b>					
100% Load			91		%
50% Load			92.5		%

Additional Notes: <sup>2</sup>.  $-40^\circ\text{C}$  to  $85^\circ\text{C}$ .

\* For models with the special feature "K".



## Operations

### Input and Output Impedance

These power converters have been designed to be stable with no external capacitors when used in low inductance input and output circuits.

In many applications, the inductance associated with the distribution from the power source to the input of the converter can affect the stability of the converter. The addition of a 33  $\mu\text{F}$  electrolytic capacitor with an ESR  $< 1 \Omega$  across the input helps ensure stability of the converter. In many applications, the user has to use decoupling capacitance at the load. The power converter will exhibit stable operation with external load capacitance up to 10,000  $\mu\text{F}$  on 5.0 V output.

Additionally, see the EMC section of this data sheet for discussion of other external components which may be required for control of conducted emissions

### ON/OFF (Pin 2)

The ON/OFF pin is used to turn the power converter on or off remotely via a system signal. There are two remote control options available, positive and negative logic, with both referenced to  $V_{in(-)}$ . A typical connection is shown in Fig. A.

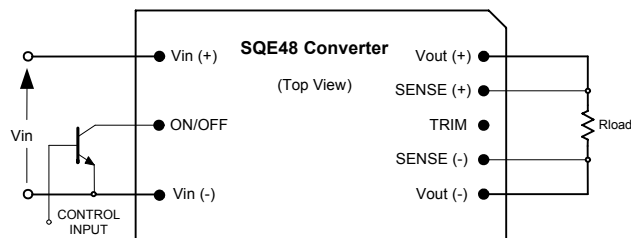

**Fig. A: Circuit configuration for ON/OFF function.**

The positive logic version turns on when the ON/OFF pin is at a logic high and turns off when at a logic low. The converter is on when the ON/OFF pin is left open. See the Electrical Specifications for logic high/low definitions.

The negative logic version turns on when the pin is at a logic low and turns off when the pin is at a logic high. The ON/OFF pin can be hard wired directly to  $V_{in(-)}$  to enable automatic power up of the converter without the need of an external control signal.

The ON/OFF pin is internally pulled up to 5 V through a resistor. A properly de-bounced mechanical switch, open-collector transistor, or FET can be used to drive the input of the ON/OFF pin.

The device must be capable of sinking up to 0.2 mA at a low level voltage of  $\leq 0.8 \text{ V}$ . An external voltage source ( $\pm 20 \text{ V}$  maximum) may be connected directly to the ON/OFF input, in which case it must be capable of sourcing or sinking up to 1 mA depending on the signal polarity. See the Startup Information section for system timing waveforms associated with use of the ON/OFF pin.

### Remote Sense (Pins 5 and 7)

The remote sense feature of the converter compensates for voltage drops occurring between the output pins of the converter and the load. The SENSE(-) (Pin 5) and SENSE(+) (Pin 7) pins should be connected at the load or at the point where regulation is required (see Fig. B).

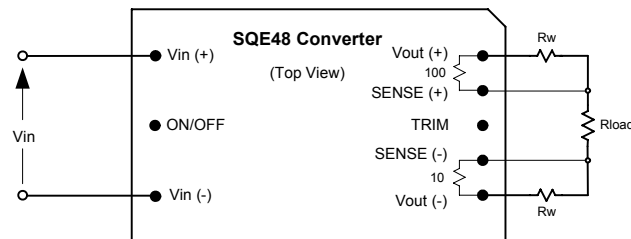

**Fig. B: Remote sense circuit configuration.**

### CAUTION

**If remote sensing is not utilized, the SENSE(-) pin must be connected to the Vout(-) pin (Pin 4), and the SENSE(+) pin must be connected to the Vout(+) pin (Pin 8) to ensure the converter will regulate at the specified output voltage. If these connections are not made, the converter will deliver an output voltage that is slightly higher than the specified data sheet value.**

Because the sense leads carry minimal current, large traces on the end-user board are not required. However, sense traces should be run side by side and located close to a ground plane to minimize system noise and ensure optimum performance.

The converter's output overvoltage protection (OVP) senses the voltage across  $V_{out(+)}$  and  $V_{out(-)}$ , and not across the sense lines, so the resistance (and resulting voltage drop) between the output pins of the converter and the load should be minimized to prevent unwanted triggering of the OVP.

When utilizing the remote sense pin feature, care must be taken not to exceed the maximum allowable output power capability of the converter, which is equal to the product of the nominal output voltage and the allowable output current for the given conditions.



When using remote sense, the output voltage at the converter can be increased by as much as 10% above the nominal rating in order to maintain the required voltage across the load. Therefore, the designer must, if necessary, decrease the maximum current (originally obtained from the derating curves) by the same percentage to ensure the converter's actual output power remains at or below the maximum allowable output power.

**Output Voltage Adjust /TRIM (Pin 6)**

The output voltage can be adjusted up 10% or down 20% relative to the rated output voltage by the addition of an externally connected resistor.

The TRIM pin should be left open if trimming is not being used. To minimize noise pickup, a 0.1  $\mu$ F capacitor is connected internally between the TRIM and SENSE(-) pins.

To increase the output voltage, refer to Fig. C. A trim resistor,  $R_{T-INCR}$ , should be connected between the TRIM (Pin 6) and SENSE(+) (Pin 7), with a value of:

$$R_{T-INCR} = \frac{5.11(100 + \Delta)V_{O-NOM} - 626}{1.225\Delta} - 10.22 \quad [k\Omega]$$

where,

$R_{T-INCR}$  = Required value of trim-up resistor  $k\Omega$

$V_{O-NOM}$  = Nominal value of output voltage [V]

$$\Delta = \left| \frac{(V_{O-REQ} - V_{O-NOM})}{V_{O-NOM}} \right| \times 100 \quad [\%]$$

$V_{O-REQ}$  = Desired (trimmed) output voltage [V].

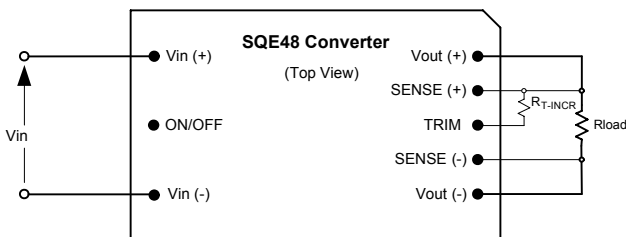

**Fig. C: Configuration for increasing output voltage.**

When trimming up, care must be taken not to exceed the converter's maximum allowable output power. See the previous section for a complete discussion of this requirement.

To decrease the output voltage (Fig. D), a trim resistor,  $R_{T-DECR}$ , should be connected between the TRIM (Pin 6) and SENSE(-) (Pin 5), with a value of:

$$R_{T-DECR} = \frac{511}{\Delta} - 10.22 \quad [k\Omega]$$

where,

$R_{T-DECR}$  = Required value of trim-down resistor  $[k\Omega]$

and  $\Delta$  is defined above.

**Note:**

The above equations for calculation of trim resistor values match those typically used in conventional industry-standard quarter-bricks and one-eighth bricks.

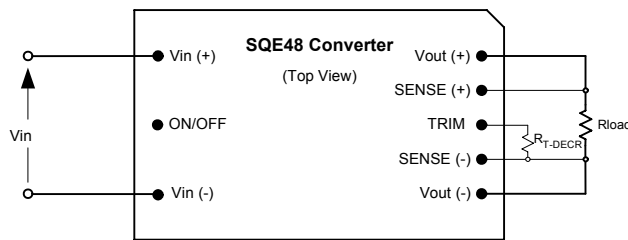

**Fig. D: Configuration for decreasing output voltage.**

Trimming/sensing beyond 110% of the rated output voltage is not an acceptable design practice, as this condition could cause unwanted triggering of the output overvoltage protection (OVP) circuit. The designer should ensure that the difference between the voltages across the converter's output pins and its sense pins does not exceed 10% of  $V_{OUT(NOM)}$ , or:

$$[V_{OUT(+)} - V_{OUT(-)}] - [V_{SENSE(+)} - V_{SENSE(-)}] \leq V_{O-NOM} \times 10\% \quad [V]$$

This equation is applicable for any condition of output sensing and/or output trim.

**Protection Features**

**Input Undervoltage Lockout**

Input undervoltage lockout is standard with this converter. The converter will shut down when the input voltage drops below a pre-determined voltage.

The input voltage must be typically 34 V for the converter to turn on. Once the converter has been turned on, it will shut off when the input voltage drops typically below 32 V. This feature is beneficial in preventing deep discharging of batteries used in telecom applications.

**Output Overcurrent Protection (OCP)**

The converter is protected against overcurrent or short circuit conditions. Upon sensing an overcurrent condition, the converter will switch to constant current operation and thereby begin to



reduce output voltage. When the output voltage drops below 60% of its nominal value, the converter will shut down (Fig. 15).

Once the converter has shut down, it will attempt to restart nominally every 200 ms with a typical 3-5% duty cycle (Fig. 16). The attempted restart will continue indefinitely until the overload or short circuit conditions are removed or the output voltage rises above 60% of its nominal value.

Once the output current is brought back into its specified range, the converter automatically exits the hiccup mode and continues normal operation.

For implementations where latching is required, a "Latching" option (L) is available for short circuit and OVP protections. The converters with the latching feature will latch off if either event occurs. The converter will attempt to restart after either the input voltage is removed and reapplied OR the ON/OFF pin is cycled.

#### **Output Overvoltage Protection (OVP)**

The converter will shut down if the output voltage across Vout(+) (Pin 8) and Vout(-) (Pin 4) exceeds the threshold of the OVP circuitry. The OVP circuitry contains its own reference, independent of the output voltage regulation loop. Once the converter has shut down, it will attempt to restart every 200 ms until the OVP condition is removed.

For implementations where latching is required, a "Latching" option (L) is available for short circuit and OVP protections. Converters with the latching feature will latch off if either event occurs. The converter will attempt to restart after either the input voltage is removed and reapplied OR the ON/OFF pin is cycled.

#### **Overtemperature Protection (OTP)**

The converter will shut down under an overtemperature condition to protect itself from overheating caused by operation outside the thermal derating curves, or operation in abnormal conditions such as system fan failure. Converter with the non-latching option will automatically restart after it has cooled to a safe operating temperature.

#### **Safety Requirements**

The converters meet North American and International safety regulatory requirements per UL60950 and EN60950. Basic Insulation is provided between input and output.

To comply with safety agencies' requirements, an input line fuse must be used external to the

converter. A 5 A fuse is recommended for use with this product.

All SQE converters are UL approved for maximum fuse rating of 15 A. To protect a group of converters with a single fuse, the rating can be increased from the recommended values above.

#### **Electromagnetic Compatibility (EMC)**

EMC requirements must be met at the end-product system level, as no specific standards dedicated to EMC characteristics of board mounted component dc-dc converters exist. However, Power-One tests its converters to several system level standards, primary of which is the more stringent EN55022, *Information technology equipment - Radio disturbance characteristics - Limits and methods of measurement*.

An effective internal LC differential filter significantly reduces input reflected ripple current (Fig. 13), and improves EMC.

With the addition of a simple external filter, all versions of the SQE48-Series of converters pass the requirements of Class B conducted emissions per EN55022 and FCC requirements. Please contact Power-One Applications Engineering for details of this testing.

#### **Characterization**

##### **General Information**

The converter has been characterized for many operational aspects, to include thermal derating (maximum load current as a function of ambient temperature and airflow) for vertical and horizontal mounting, efficiency, startup and shutdown parameters, output ripple and noise, transient response to load step-change, overload, and short circuit.

The figures are numbered as Fig. x.y, where x indicates the different output voltages, and y associates with specific plots (y = 1 for the vertical thermal derating, ...). For example, Fig. x.1 will refer to the vertical thermal derating for all the output voltages in general.

The following pages contain specific plots or waveforms associated with the converter. Additional comments for specific data are provided below.

#### **Test Conditions**



All data presented were taken with the converter soldered to a test board, specifically a 0.060" thick printed wiring board (PWB) with four layers. The top and bottom layers were not metalized. The two inner layers, comprised of two-ounce copper, were used to provide traces for connectivity to the converter.

The lack of metalization on the outer layers as well as the limited thermal connection ensured that heat transfer from the converter to the PWB was minimized. This provides a worst-case but consistent scenario for thermal derating purposes.

All measurements requiring airflow were made in the vertical and horizontal wind tunnel using Infrared (IR) thermography and thermocouples for thermometry.

Ensuring components on the converter do not exceed their ratings is important to maintaining high reliability. If one anticipates operating the converter at or close to the maximum loads specified in the derating curves, it is prudent to check actual operating temperatures in the application. Thermographic imaging is preferable; if this capability is not available, then thermocouples may be used. The use of AWG #40 gauge thermocouples is recommended to ensure measurement accuracy. Careful routing of the thermocouple leads will further minimize measurement error. Refer to Fig. E for optimum measuring thermocouple location.

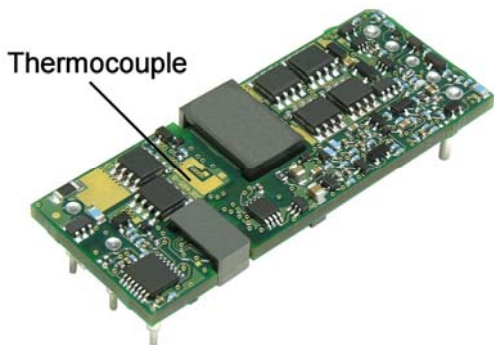

**Fig. E:** Location of the thermocouple for thermal testing.

### Thermal Derating

Load current vs. ambient temperature and airflow rates are given in Fig. 1 and Fig. 2. Ambient temperature was varied between 25 °C and 85 °C, with airflow rates from 30 to 500 LFM (0.15 to 2.5 m/s), for vertical and horizontal converter mounting.

For each set of conditions, the maximum load current was defined as the lowest of:

(i) The output current at which any FET junction temperature does not exceed a maximum

specified temperature (120 °C) as indicated by the thermographic image, or

(ii) The temperature of the transformer does not exceed 120 °C, or

(iii) The nominal rating of the converter (20 A).

During normal operation, derating curves with maximum FET temperature less or equal to 120 °C should not be exceeded. Temperature at the thermocouple location shown in Fig. E should not exceed 120 °C in order to operate inside the derating curves.

### Efficiency

Efficiency vs. load current plot is shown in Fig. 3 for ambient temperature of 25 °C, airflow rate of 300 LFM (1.5 m/s), vertical converter mounting, and input voltages of 36 V, 48 V, and 72 V. Also, a plot of efficiency vs. load current, as a function of ambient temperature with  $V_{in} = 48$  V, airflow rate of 200 LFM (1 m/s) with vertical mounting is shown in Fig. 4.

### Power Dissipation

Fig. 5 shows the power dissipation vs. load current plot for  $T_a = 25$  °C, airflow rate of 300 LFM (1.5 m/s) with vertical mounting and input voltages of 36 V, 48 V, and 72 V. Also, a plot of power dissipation vs. load current, as a function of ambient temperature with  $V_{in} = 48$  V, airflow rate of 200 LFM (1 m/s) with vertical mounting is shown in Fig. 6.

### Startup

Output voltage waveforms, during the turn-on transient using the ON/OFF pin for full rated load currents (resistive load) are shown without and with external load capacitance in Fig. 7 and Fig. 8, respectively.

### Ripple and Noise

Fig. 11 shows the output voltage ripple waveform, measured at full rated load current with a 10  $\mu$ F tantalum and 1  $\mu$ F ceramic capacitor across the output. Note that all output voltage waveforms are measured across a 1  $\mu$ F ceramic capacitor.

The input reflected ripple current waveforms are obtained using the test setup shown in Fig. 12. The corresponding waveforms are shown in Fig. 13 and Fig. 14.



**Startup Information (using negative ON/OFF)**

**Scenario #1: Initial Startup From Bulk Supply**

ON/OFF function enabled, converter started via application of  $V_{IN}$ . See Figure. F.

Time	Comments
$t_0$	ON/OFF pin is ON; system front end power is toggled on, $V_{IN}$ to converter begins to rise.
$t_1$	$V_{IN}$ crosses Undervoltage Lockout protection circuit threshold; converter enabled.
$t_2$	Converter begins to respond to turn-on command (converter turn-on delay).
$t_3$	Converter $V_{OUT}$ reaches 100% of nominal value.

For this example, the total converter startup time ( $t_3 - t_1$ ) is typically 4 ms.

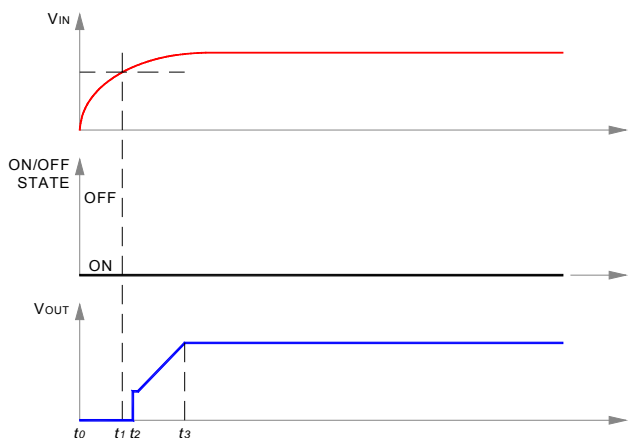

Fig. F: Startup scenario #1.

**Scenario #2: Initial Startup Using ON/OFF Pin**

With  $V_{IN}$  previously powered, converter started via ON/OFF pin. See Figure. G.

Time	Comments
$t_0$	$V_{INPUT}$ at nominal value.
$t_1$	Arbitrary time when ON/OFF pin is enabled (converter enabled).
$t_2$	End of converter turn-on delay.
$t_3$	Converter $V_{OUT}$ reaches 100% of nominal value.

For this example, the total converter startup time ( $t_3 - t_1$ ) is typically 4 ms.

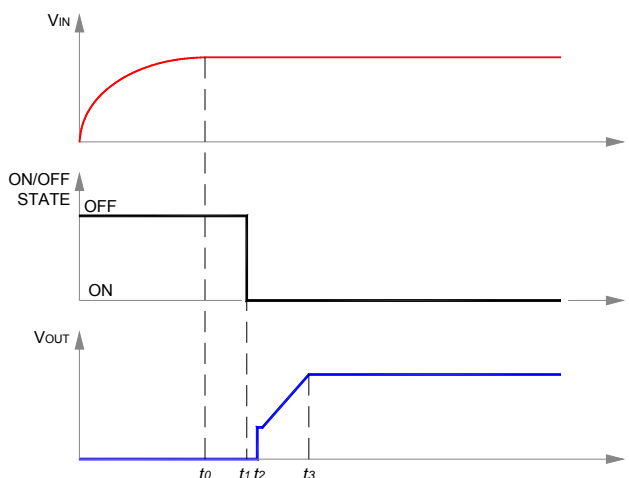

Fig. G: Startup scenario #2.

**Scenario #3: Turn-off and Restart Using ON/OFF Pin**

With  $V_{IN}$  previously powered, converter is disabled and then enabled via ON/OFF pin. See Figure. H.

Time	Comments
$t_0$	$V_{IN}$ and $V_{OUT}$ are at nominal values; ON/OFF pin ON.
$t_1$	ON/OFF pin arbitrarily disabled; converter output falls to zero; turn-on inhibit delay period (200 ms typical) is initiated, and ON/OFF pin action is internally inhibited.
$t_2$	ON/OFF pin is externally re-enabled. If $(t_2 - t_1) \leq 200$ ms, external action of ON/OFF pin is locked out by startup inhibit timer. If $(t_2 - t_1) > 200$ ms, ON/OFF pin action is internally enabled.
$t_3$	Turn-on inhibit delay period ends. If ON/OFF pin is ON, converter begins turn-on; if off, converter awaits ON/OFF pin ON signal; see Figure. G.
$t_4$	End of converter turn-on delay.
$t_5$	Converter $V_{OUT}$ reaches 100% of nominal value.

For the condition  $(t_2 - t_1) \leq 200$  ms, the total converter startup time ( $t_5 - t_2$ ) is typically 204 ms. For  $(t_2 - t_1) > 200$  ms, startup will be typically 4 ms after release of ON/OFF pin.

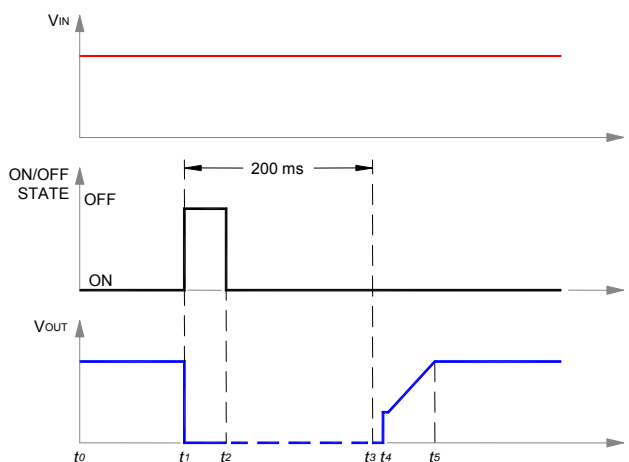

Fig. H: Startup scenario #3.



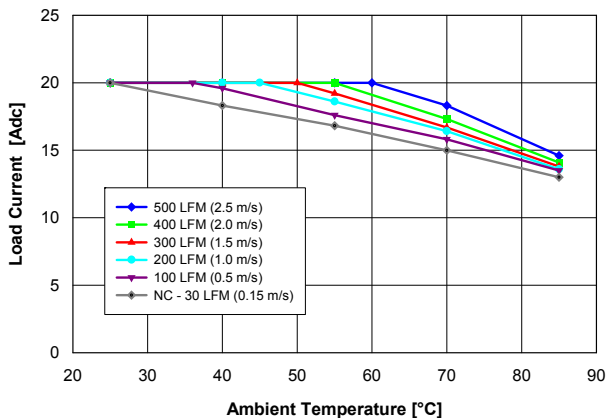

Fig. 1: Available load current vs. ambient air temperature and airflow rates for converter with G height pins mounted vertically with air flowing from pin 1 to pin 3 and maximum FET temperature  $\leq 120^\circ\text{C}$ ,  $V_{in} = 48\text{ V}$ .

Note: NC – Natural convection

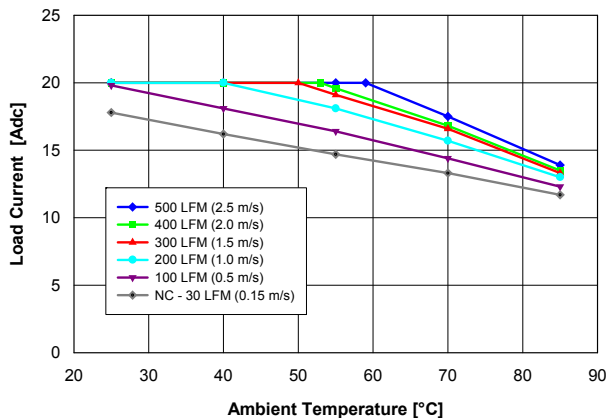

Fig. 2: Available load current vs. ambient air temperature and airflow rates for converter with G height pins mounted horizontally with air flowing from pin 1 to pin 3 and maximum FET temperature  $\leq 120^\circ\text{C}$ ,  $V_{in} = 48\text{ V}$ .

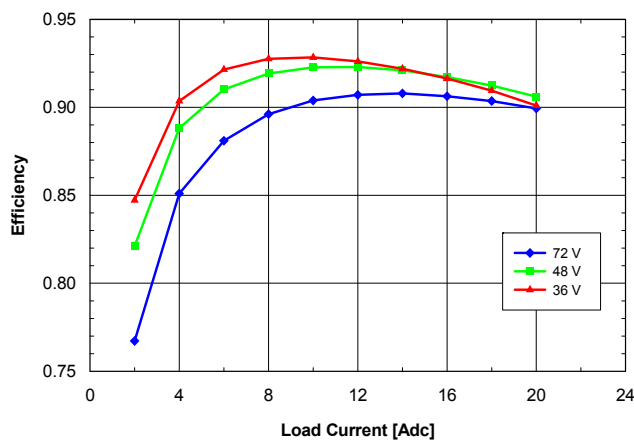

Fig. 3: Efficiency vs. load current and input voltage for converter mounted vertically with air flowing from pin 1 to pin 3 at a rate of 300 LFM (1.5 m/s) and  $T_a = 25^\circ\text{C}$ .

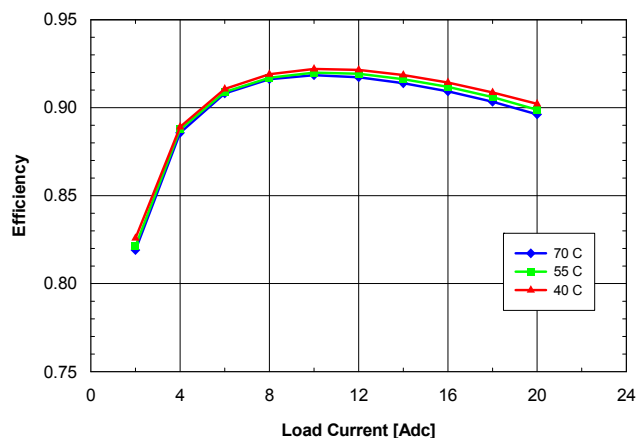

Fig. 4: Efficiency vs. load current and ambient temperature for converter mounted vertically with  $V_{in} = 48\text{ V}$  and air flowing from pin 1 to pin 3 at a rate of 200 LFM (1.0 m/s).

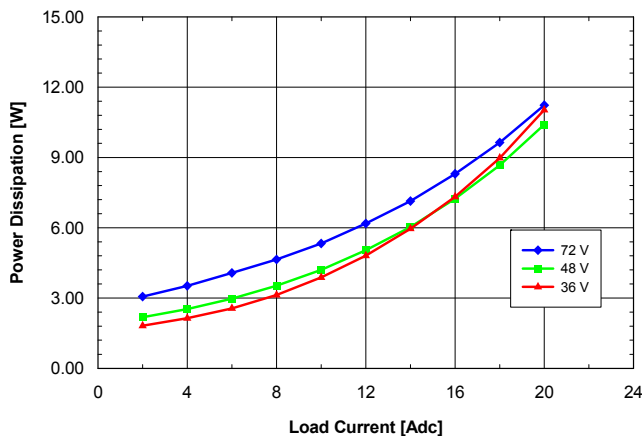

Fig. 5: Power dissipation vs. load current and input voltage for converter mounted vertically with air flowing from pin 1 to pin 3 at a rate of 300 LFM (1.5 m/s) and  $T_a = 25\text{ }^\circ\text{C}$ .

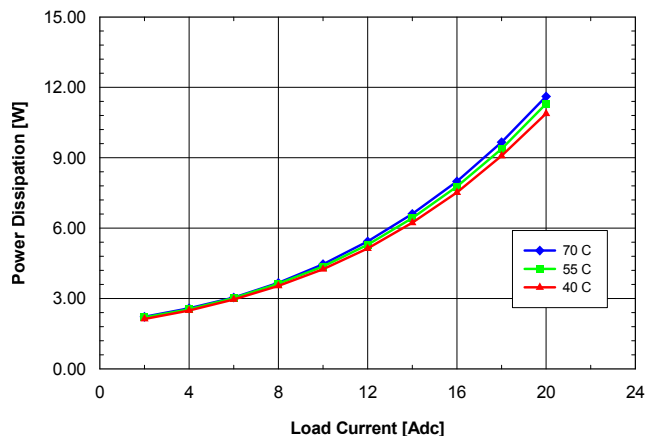

Fig. 6: Power dissipation vs. load current and ambient temperature for converter mounted vertically with  $V_{in} = 48\text{ V}$  and air flowing from pin 1 to pin 3 at a rate of 200 LFM (1.0 m/s).

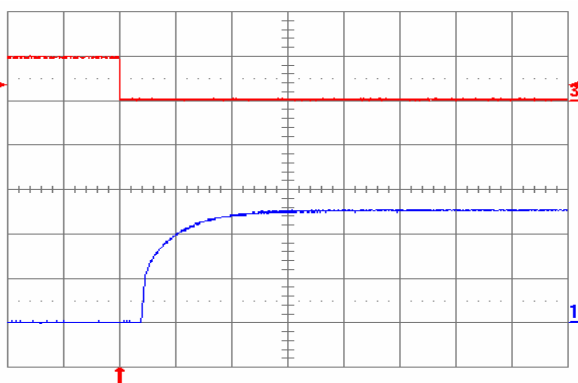

Fig. 7: Turn-on transient at full rated load current (resistive) with no output capacitor at  $V_{in} = 48\text{ V}$ , triggered via ON/OFF pin. Top trace: ON/OFF signal (5 V/div.). Bottom trace: output voltage (2 V/div.). Time scale: 2 ms/div.

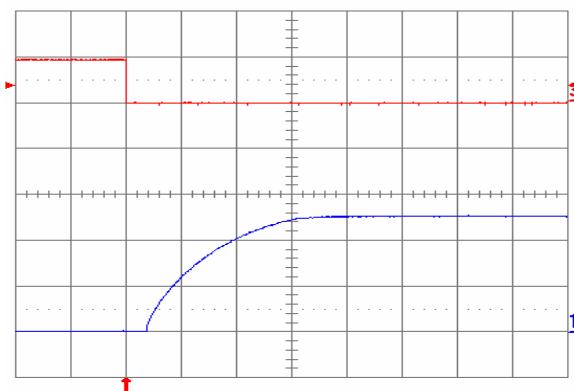

Fig. 8: Turn-on transient at full rated load current (resistive) plus 10,000  $\mu\text{F}$  at  $V_{in} = 48\text{ V}$ , triggered via ON/OFF pin. Top trace: ON/OFF signal (5 V/div.). Bottom trace: output voltage (2 V/div.). Time scale: 2 ms/div.

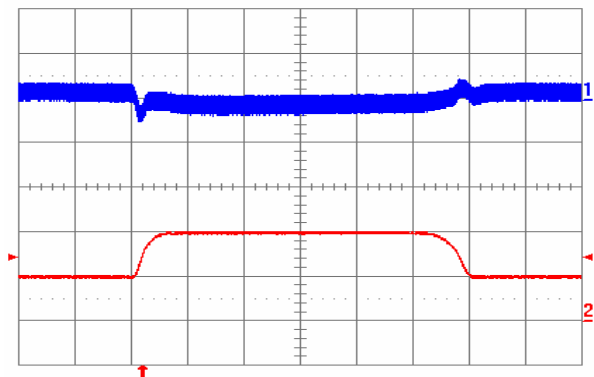

Fig. 9: Output voltage response to load current step-change (10 A – 20 A – 10 A) at  $V_{in} = 48$  V. Top trace: output voltage (100 mV/div.). Bottom trace: load current (10 A/div.). Current slew rate: 0.1 A/ $\mu$ s.  $C_o = 1$   $\mu$ F ceramic. Time scale: 0.2 ms/div.

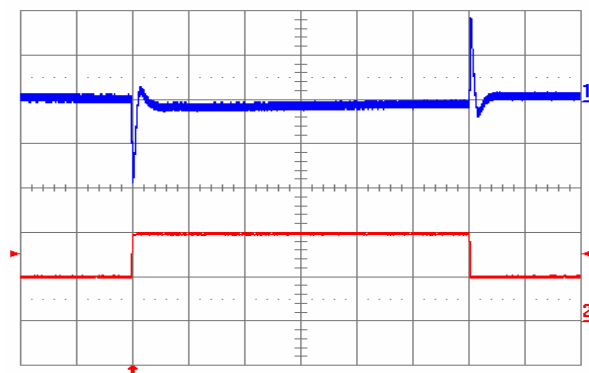

Fig. 10: Output voltage response to load current step-change (10 A – 20 A – 10 A) at  $V_{in} = 48$  V. Top trace: output voltage (100 mV/div.). Bottom trace: load current (10 A/div.). Current slew rate: 5 A/ $\mu$ s.  $C_o = 470$   $\mu$ F POS + 1  $\mu$ F ceramic. Time scale: 0.2 ms/div.

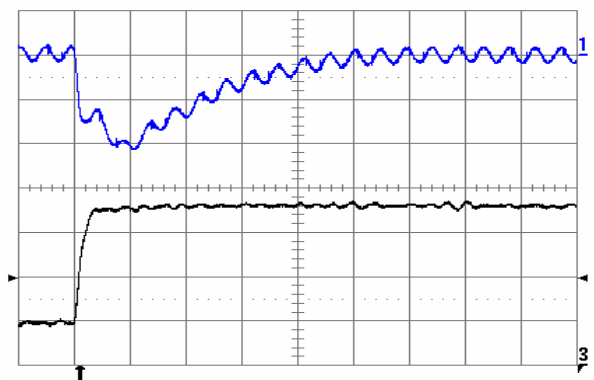

Fig. 10a\*: Output voltage response to load current step-change (10 A – 15 A – 10 A) at  $V_{in} = 48$  V. Top trace: output voltage (50 mV/div.). Bottom trace: load current (2 A/div.). Current slew rate: 2.5 A/ $\mu$ s.  $C_o = 2 \times 100$   $\mu$ F TA + 1  $\mu$ F ceramic. Time scale: 5  $\mu$ s/div.

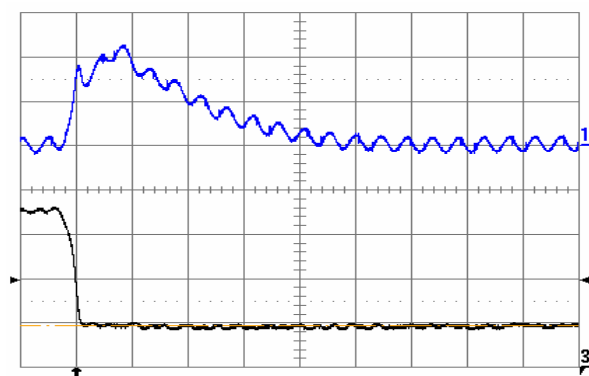

Fig. 10b\*: Output voltage response to load current step-change (10 A – 15 A – 10 A) at  $V_{in} = 48$  V. Top trace: output voltage (50 mV/div.). Bottom trace: load current (2 A/div.). Current slew rate: 2.5 A/ $\mu$ s.  $C_o = 2 \times 100$   $\mu$ F TA + 1  $\mu$ F ceramic. Time scale: 5  $\mu$ s/div.

\* For models with the special feature "K".

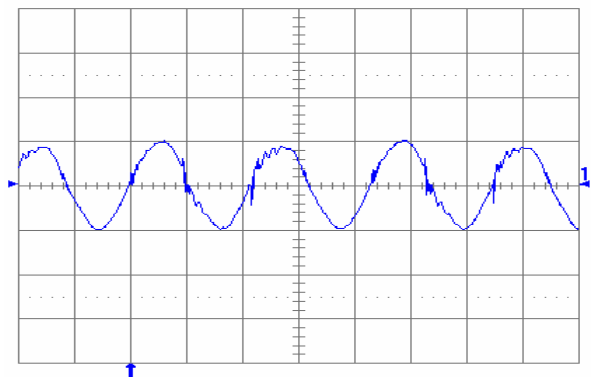

Fig. 11: Output voltage ripple (20 mV/div.) at full rated load current into a resistive load with  $C_o = 10$   $\mu$ F tantalum + 1  $\mu$ F ceramic and  $V_{in} = 48$  V. Time scale: 1  $\mu$ s/div.

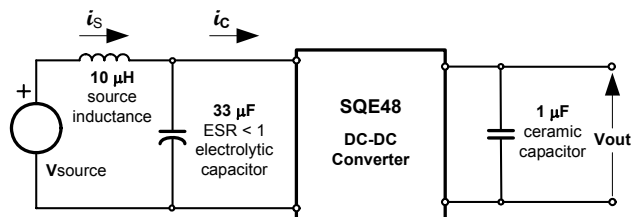

Fig. 12: Test Setup for measuring input reflected ripple currents,  $i_c$  and  $i_s$ .

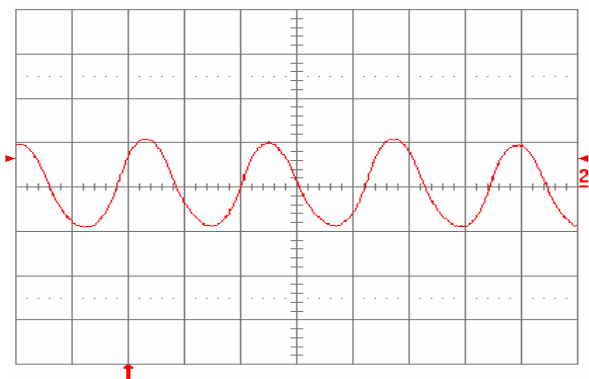

Fig. 13: Input reflected ripple current,  $i_c$  (100 mA/div.), measured at input terminals at full rated load current and  $V_{in} = 48$  V. Refer to Fig. 12 for test setup. Time scale: 1  $\mu$ s/div.

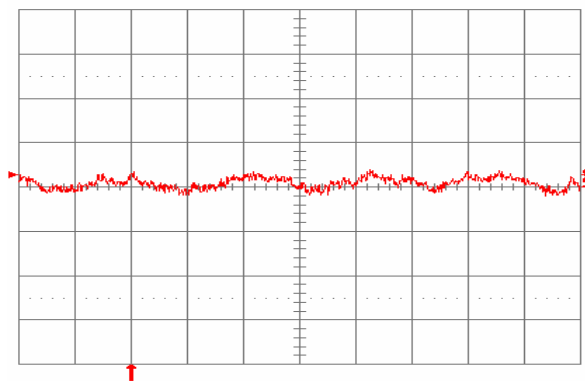

Fig. 14: Input reflected ripple current,  $i_s$  (10 mA/div.), measured through 10  $\mu$ H at the source at full rated load current and  $V_{in} = 48$  V. Refer to Fig. 12 for test setup. Time scale: 1  $\mu$ s/div.

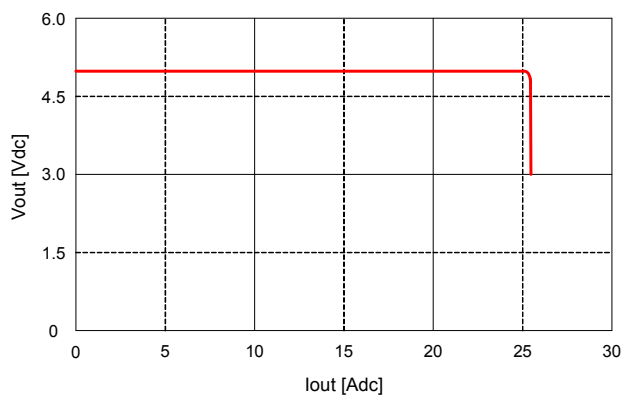

Fig. 15: Output voltage vs. load current showing current limit point and converter shutdown point. Input voltage has almost no effect on current limit characteristic.

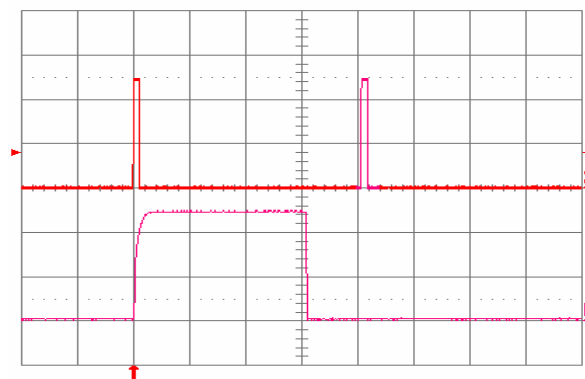

Fig. 16: Load current (top trace, 10 A/div., 50 ms/div.) into a 10  $m\Omega$  short circuit during restart, at  $V_{in} = 48$  V. Bottom trace (10 A/div., 2 ms/div.) is an expansion of the on-time portion of the top trace.

# SQE48T20050 DC-DC Converter Data Sheet

## 36-75 VDC Input; 5.0 VDC @ 20 A Output



### Physical Information (For standard and latching option)

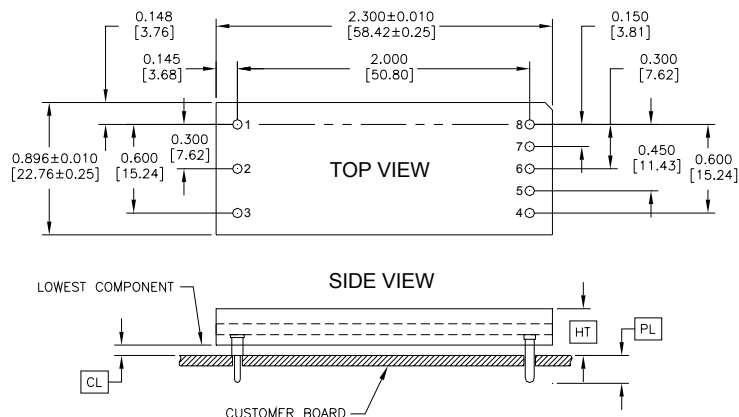

Pad/Pin Connections	
Pad/Pin #	Function
1	Vin (+)
2	ON/OFF
3	Vin (-)
4	Vout (-)
5	SENSE(-)
6	TRIM
7	SENSE(+)
8	Vout (+)

### SQE48T Pinout (Through-hole)

Height Option	HT (Max. Height)	CL (Min. Clearance)	Pin Option	PL Pin Length
	+0.000 [+0.00] -0.038 [- 0.97]	+0.016 [+0.41] -0.000 [- 0.00]		
G	0.407 [10.34]	0.035 [0.89]	A	0.188 [4.77]
			B	0.145 [3.68]

### SQE48T Platform Notes

- All dimensions are in inches [mm]
- Pins 1-3 and 5-7 are  $\varnothing$  0.040" [1.02] with  $\varnothing$  0.078" [1.98] shoulder
- Pins 4 and 8 are  $\varnothing$  0.062" [1.57] without shoulder
- Pin Material: Brass Alloy 360
- Pin Finish: Matte Tin over Nickel
- Converter Weight: 0.72 oz [20.6 g]

### Converter Part Numbering/Ordering Information

Product Series	Input Voltage	Mounting Scheme	Rated Load Current	Output Voltage	ON/OFF Logic	Maximum Height [HT]	Pin Length [PL]	Special Features	RoHS
SQE	48	T	20	050	-	N	G	0	G
One-Eighth Brick Format	36-75 V	T $\Rightarrow$ Through-hole	20 A	050 $\Rightarrow$ 5.0 V	N $\Rightarrow$ Negative P $\Rightarrow$ Positive	Through hole G $\Rightarrow$ 0.407"	Through hole A $\Rightarrow$ 0.188" B $\Rightarrow$ 0.145"	0 $\Rightarrow$ STD (Non-Latching) L $\Rightarrow$ Latching Option	No Suffix $\Rightarrow$ RoHS lead-solder-exemption compliant G $\Rightarrow$ RoHS compliant for all six substances

The example above describes P/N SQE48T20050-NGB0G: 36-75 V input, through-hole mounting, 20 A @ 5.0 V output, negative ON/OFF logic, a maximum height of 0.407", and a through the board pin length of 0.145", standard (non-latching), and RoHS compliant. Please consult factory for the complete list of available options.

# SQE48T20050 DC-DC Converter Data Sheet

## 36-75 VDC Input; 5.0 VDC @ 20 A Output



### Physical Information (For special feature "K")

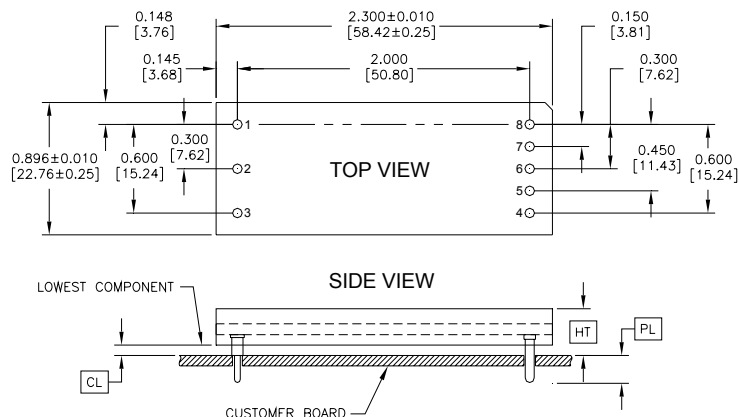

Pad/Pin Connections	
Pad/Pin #	Function
1	Vin (+)
2	ON/OFF
3	Vin (-)
4	Vout (-)
5	SENSE(-)
6	TRIM
7	SENSE(+)
8	Vout (+)

### SQE48T Pinout (Through-hole)

Height Option	HT (Max. Height)	CL (Min. Clearance)	Pin Option	PL Pin Length
	+0.000 [+0.00] -0.038 [-0.97]	+0.016 [+0.41] -0.000 [-0.00]		
D*	0.374 [9.5]	0.045 [1.14]	A	0.188 [4.77]
			B	0.145 [3.68]

### SQE48T Platform Notes

- All dimensions are in inches [mm]
- Pins 1-3 and 5-7 are Ø 0.040" [1.02] with Ø 0.078" [1.98] shoulder
- Pins 4 and 8 are Ø 0.062" [1.57] without shoulder
- Pin Material: CDA 145
- Pin Finish: Tin over Nickel
- Converter Weight: 0.72 oz [20.6 g]

### Converter Part Numbering/Ordering Information

Product Series	Input Voltage	Mounting Scheme	Rated Load Current	Output Voltage	ON/OFF Logic	Maximum Height [HT]	Pin Length [PL]	Special Features	RoHS	
SQE	48	T	20	050	-	N	D	A	K	G
One-Eighth Brick Format	36-75 V	T ⇒ Through-hole	20 A	050 ⇒ 5.0 V	N ⇒ Negative P ⇒ Positive	Through hole D* ⇒ 0.374"	Through hole A ⇒ 0.188" B ⇒ 0.145"	K ⇒ Overall Max. Height of 9.5 mm	No Suffix ⇒ RoHS lead solder exemption compliant G ⇒ RoHS compliant for all six substances	

The example above describes P/N SQE48T20050-NDAKG: 36-75 V input, through-hole mounting, 20 A @ 5.0 V output, negative ON/OFF logic, a maximum height of 0.374", and a through the board pin length of 0.188", standard (non-latching), and RoHS compliant. Please consult factory for the complete list of available options.

\* Models have an overall maximum height of 0.374" [9.5 mm] and a standard non-latching feature.

**NUCLEAR AND MEDICAL APPLICATIONS** - Power-One products are not designed, intended for use in, or authorized for use as critical components in life support systems, equipment used in hazardous environments, or nuclear control systems without the express written consent of the respective divisional president of Power-One, Inc.

**TECHNICAL REVISIONS** - The appearance of products, including safety agency certifications pictured on labels, may change depending on the date manufactured. Specifications are subject to change without notice.

Компания «Океан Электроники» предлагает заключение долгосрочных отношений при поставках импортных электронных компонентов на взаимовыгодных условиях!

Наши преимущества:

- Поставка оригинальных импортных электронных компонентов напрямую с производств Америки, Европы и Азии, а так же с крупнейших складов мира;
- Широкая линейка поставок активных и пассивных импортных электронных компонентов (более 30 млн. наименований);
- Поставка сложных, дефицитных, либо снятых с производства позиций;
- Оперативные сроки поставки под заказ (от 5 рабочих дней);
- Экспресс доставка в любую точку России;
- Помощь Конструкторского Отдела и консультации квалифицированных инженеров;
- Техническая поддержка проекта, помощь в подборе аналогов, поставка прототипов;
- Поставка электронных компонентов под контролем ВП;
- Система менеджмента качества сертифицирована по Международному стандарту ISO 9001;
- При необходимости вся продукция военного и аэрокосмического назначения проходит испытания и сертификацию в лаборатории (по согласованию с заказчиком);
- Поставка специализированных компонентов военного и аэрокосмического уровня качества (Xilinx, Altera, Analog Devices, Intersil, Interpoint, Microsemi, Actel, Aeroflex, Peregrine, VPT, Syfer, Eurofarad, Texas Instruments, MS Kennedy, Miteq, Cobham, E2V, MA-COM, Hittite, Mini-Circuits, General Dynamics и др.);

Компания «Океан Электроники» является официальным дистрибьютором и эксклюзивным представителем в России одного из крупнейших производителей разъемов военного и аэрокосмического назначения «JONHON», а так же официальным дистрибьютором и эксклюзивным представителем в России производителя высокотехнологичных и надежных решений для передачи СВЧ сигналов «FORSTAR».



## JONHON

«JONHON» (основан в 1970 г.)

Разъемы специального, военного и аэрокосмического назначения:

(Применяются в военной, авиационной, аэрокосмической, морской, железнодорожной, горно- и нефтедобывающей отраслях промышленности)

«FORSTAR» (основан в 1998 г.)

ВЧ соединители, коаксиальные кабели, кабельные сборки и микроволновые компоненты:

(Применяются в телекоммуникациях гражданского и специального назначения, в средствах связи, РЛС, а так же военной, авиационной и аэрокосмической отраслях промышленности).



Телефон: 8 (812) 309-75-97 (многоканальный)

Факс: 8 (812) 320-03-32

Электронная почта: [ocean@oceanchips.ru](mailto:ocean@oceanchips.ru)

Web: <http://oceanchips.ru/>

Адрес: 198099, г. Санкт-Петербург, ул. Калинина, д. 2, корп. 4, лит. А