



**BOURNS®**

### Features

- Incremental encoder / quadrature output
- Exceptionally long operating life
- High operating temperature capabilities - up to 125°C
- Sturdy construction
- Bushing mount
- Available with PC board mounting bracket (optional)

## ECW - Digital Contacting Encoder

### Electrical Characteristics

Output .....	2-bit gray code, Channel A leads Channel B by 90° electrically turning clockwise (CW)
Closed Circuit Resistance .....	5 ohms maximum
Open Circuit Resistance .....	100K ohms minimum
Contact Rating .....	10 milliamp @ 10 VDC or 0.1 watt maximum
Insulation Resistance (500 VDC) .....	1,000 megohms minimum
Dielectric Withstanding Voltage .....	MIL-STD-202 Method 301
Sea Level .....	1,000 VAC minimum
Electrical Travel .....	Continuous
Contact Bounce (15 RPM) .....	5 milliseconds maximum
RPM (Operating) .....	120 maximum

### Environmental Characteristics

Storage Temperature Range .....	-40°C to +140°C
Operating Temperature Range .....	+1°C to +125°C
Humidity .....	MIL-STD-202, Method 103B, Condition B
Vibration .....	15G
Contact Bounce .....	0.1 millisecond maximum
Shock .....	50G
Contact Bounce .....	0.1 millisecond maximum
Rotational Life .....	200,000 shaft revolutions*

### Mechanical Characteristics

Mechanical Angle .....	Continuous
Weight .....	Approximately 0.75 oz.
Torque (Detented) .....	0.75 to 2.25 oz-in.
Mounting Torque .....	7 in-lbs. maximum
Shaft Side Load (Static) .....	10 lbs. minimum

\*Applies to EC Option.

### QUADRATURE OUTPUT TABLE

This table is intended to show available outputs as currently defined.

#### 1/4 CYCLE PER DETENT

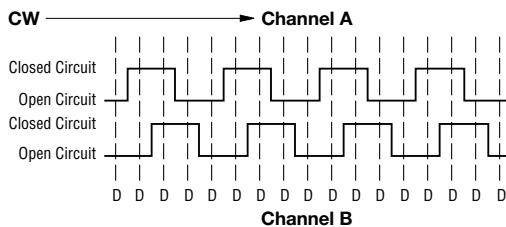

#### FULL CYCLE PER DETENT (Normally Open in Detent Shown)

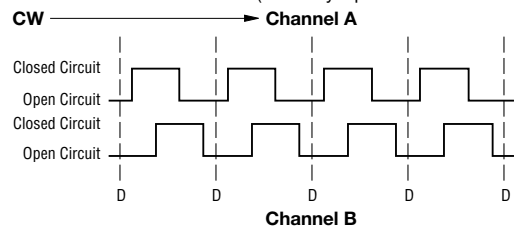

### RECOMMENDED INCREMENTAL CONTROL DIAGRAM

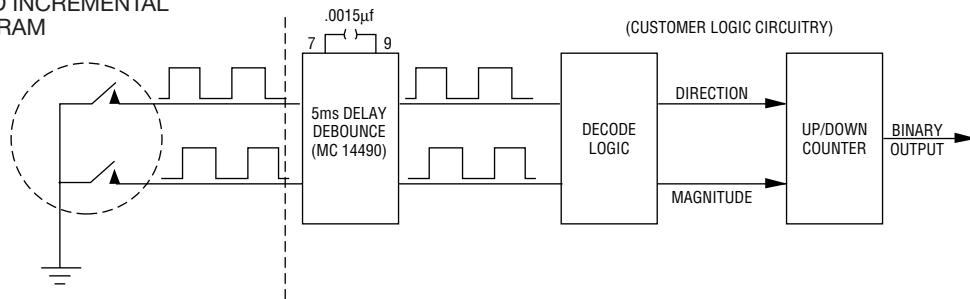

## DIGITAL CONTACTING

The Digital Contacting Encoder is commonly referred to by such names as Digital Panel Control, Bit Switch, Gray Switch and Digital Switch. All such names are synonymous with a device whose output is a digital gray code signal, rather than a conventional potentiometric voltage ratio output.

The advantage of the Digital Contacting Encoder is that it permits the direct entry of digitized analog data into a digital circuit without A/D

conversion. The two (2) channel gray coded signal of this incremental encoder allows the user's decoder circuit to sense analog direction of rotation, as well as up-down counter capabilities . . . all without the time and cost required for A/D conversion. This approach can reduce memory overhead, wiring and wiring interconnects, and can provide greater MPU program speed.

# ECW - Digital Contacting Encoder

# BOURNS®

### BUSHING MOUNTED - HOUSING A

W style bushing shown.

Shaft lengths "L" for B, C, R and Y styles  
 24 = .750" (19mm)  
 36 = 1.125" (28.5mm)

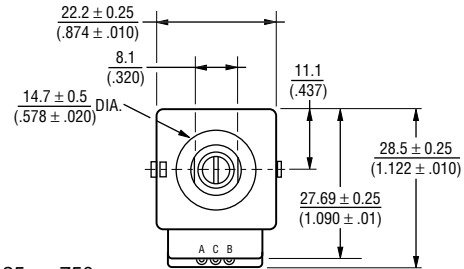
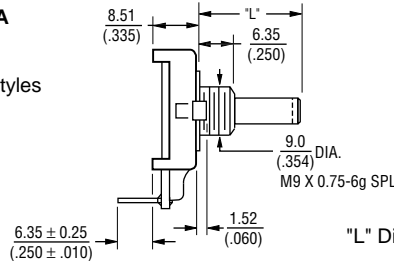

"L" Dim. = 1.125 or .750

### PCB BRACKET MOUNTED - HOUSING B

Dimensions not given are the same as Bushing Mounted.



### SOLDER HOLES - HOUSING C

Dimensions not given are the same as Bushing Mounted.

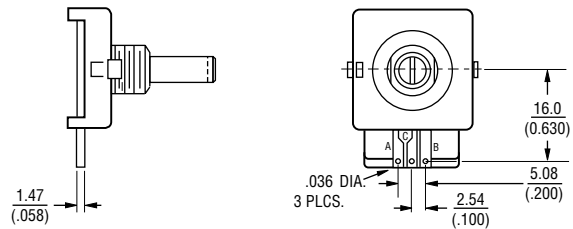

### SNAP-IN MOUNT - Housing G

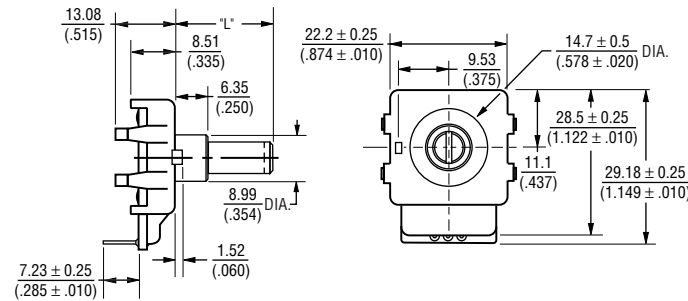

### PCB MOUNTING DIMENSIONS

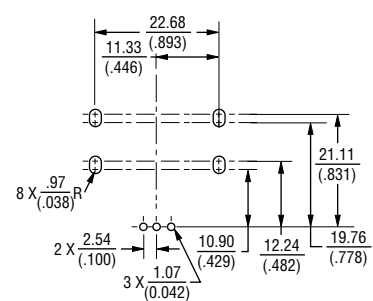

### Shaft Style B

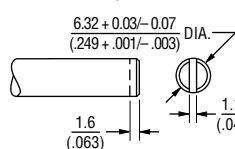

### Shaft Style C

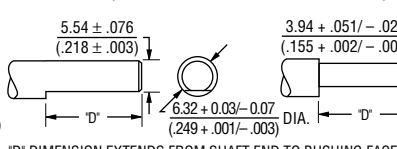

### Shaft Style J

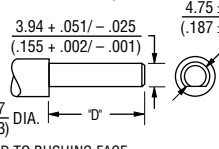

### Shaft Style R

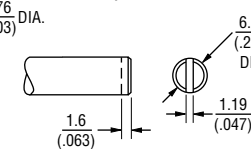

### Shaft Style Y

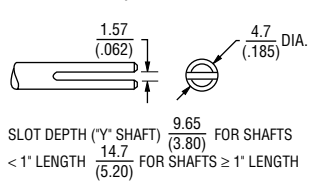

"D" DIMENSION EXTENDS FROM SHAFT END TO BUSHING FACE  
 "D" = (SHAFT LENGTH, FMS) - (BUSHING LENGTH)

### PANEL HOLE DIMENSIONS

Bushing Mounted

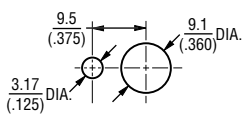

### PCB MOUNTING DIMENSIONS

(Housing Styles B and E)

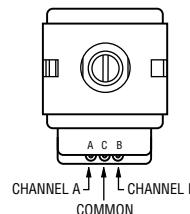
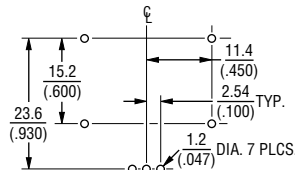

FOR TOLERANCES NOT SHOWN  
 .XX = ± .010  
 .XXX = ± .005  
 SHAFT DIMENSIONS ± 1/32"

DIMENSIONS ARE: METRIC / INCHES

# ECW - Digital Contacting Encoder - How To Order



## PART NUMBERING SYSTEM

**E C W 1 J - B 2 4 - B C 0 0 2 4**

Code	Rotational Life
C	200,000 Revolutions

BUSHING CONFIGURATION	
Code	Description
W	9mm x 1/4" Length. Threaded M9x0.75
L	9mm x 3/8" Length. Threaded M9x0.75 (Use B shaft only.)
T	9mm x 1/4". No Thread.

**SWITCHING CONFIGURATION (In Detent Position)**  
Applies to performance codes B0012 and C0024 only, use code "0" for all other performance codes.

Code	Description
0	Not Applicable
1	Normally Open
2	Normally Closed

ANTI-ROTATION LUG POSITION	
Code	Description
J	9:00 Position
D	None

SHAFT STYLE (See Outline Drawing for Details)	
Code	Description
B	Plain with Inserted Slot (1/4" Dia.)
C	Single Flatted (1/4" Dia.)
R	Plain with Inserted Slot (6mm Dia.)
Y	Split Shaft Version (.185" Dia.)
J	Flatted Shaft (3/16" Dia.)

PERFORMANCE CODE		
Code	Detents	Cycles/Rev.
E0006		6
E0009		9
E0012	0	12
E0024		24
B0012	12	12
C0006		6
C0024	24	24
D0009	36	9

## HOUSING TERMINAL CONFIGURATION (X indicates "Equipped With")

Features	Code						
	A	B	C	D	E	F	G*
Terminal Cover	X	X			X		X
Terminals	X	X			X		X
Solder Holes			X	X		X	
PCB Bracket		X		X	X	X	
Hardware Included	X		X		X	X	
Snap-In Mount							X

\*Bushing code T only.

## SHAFT LENGTH (FMS)

Code	Description	Available Shaft Styles
16	1/2" Length	B
20	5/8" (15.9mm) Length	J
24	3/4" (19mm) Length	B, C, J, Y
28	7/8" (22.2mm) Length	B, C, J, Y
32	1" (25.4mm) Length	B, C, J, Y
36	1-1/8" (28.6mm) Length	B, C, J, Y
Metric		
19	19mm Length	R
22	22mm Length	R
24	24mm Length	R

The sample part number demonstrates the identification code for Bourns contacting encoders. The part number shown is a commonly used model, typically available from stock.

Компания «Океан Электроники» предлагает заключение долгосрочных отношений при поставках импортных электронных компонентов на взаимовыгодных условиях!

Наши преимущества:

- Поставка оригинальных импортных электронных компонентов напрямую с производств Америки, Европы и Азии, а так же с крупнейших складов мира;
- Широкая линейка поставок активных и пассивных импортных электронных компонентов (более 30 млн. наименований);
- Поставка сложных, дефицитных, либо снятых с производства позиций;
- Оперативные сроки поставки под заказ (от 5 рабочих дней);
- Экспресс доставка в любую точку России;
- Помощь Конструкторского Отдела и консультации квалифицированных инженеров;
- Техническая поддержка проекта, помощь в подборе аналогов, поставка прототипов;
- Поставка электронных компонентов под контролем ВП;
- Система менеджмента качества сертифицирована по Международному стандарту ISO 9001;
- При необходимости вся продукция военного и аэрокосмического назначения проходит испытания и сертификацию в лаборатории (по согласованию с заказчиком);
- Поставка специализированных компонентов военного и аэрокосмического уровня качества (Xilinx, Altera, Analog Devices, Intersil, Interpoint, Microsemi, Actel, Aeroflex, Peregrine, VPT, Syfer, Eurofarad, Texas Instruments, MS Kennedy, Miteq, Cobham, E2V, MA-COM, Hittite, Mini-Circuits, General Dynamics и др.);

Компания «Океан Электроники» является официальным дистрибьютором и эксклюзивным представителем в России одного из крупнейших производителей разъемов военного и аэрокосмического назначения «JONHON», а так же официальным дистрибьютором и эксклюзивным представителем в России производителя высокотехнологичных и надежных решений для передачи СВЧ сигналов «FORSTAR».



## JONHON

«JONHON» (основан в 1970 г.)

Разъемы специального, военного и аэрокосмического назначения:

(Применяются в военной, авиационной, аэрокосмической, морской, железнодорожной, горно- и нефтедобывающей отраслях промышленности)

«FORSTAR» (основан в 1998 г.)

ВЧ соединители, коаксиальные кабели, кабельные сборки и микроволновые компоненты:

(Применяются в телекоммуникациях гражданского и специального назначения, в средствах связи, РЛС, а так же военной, авиационной и аэрокосмической отраслях промышленности).



Телефон: 8 (812) 309-75-97 (многоканальный)

Факс: 8 (812) 320-03-32

Электронная почта: [ocean@oceanchips.ru](mailto:ocean@oceanchips.ru)

Web: <http://oceanchips.ru/>

Адрес: 198099, г. Санкт-Петербург, ул. Калинина, д. 2, корп. 4, лит. А