

## 4 W Power Amplifier 7.1 - 7.9 GHz

Rev. V1

### Features

- 22.0 dB Small Signal Gain
- 46.5 dBm Third Order Intercept Point (OIP3)
- >36.5 dBm Saturated Output Power ( $P_{SAT}$ )
- Bias 2000 mA at 8 V
- Lead-Free 7mm Copper Coin Air Cavity Package
- RoHS\* Compliant

### Description

The MAAP-011161 is a packaged linear power amplifier that operates from 7.1 - 7.9 GHz. The device provides 22 dB gain and 46.5 dBm Output Third Order Intercept Point (OIP3) with >35.5 dBm saturated output power ( $P_{SAT}$ ).

The packaged amplifier comes in an air cavity 7 mm surface mount package with a copper coin paddle and is comprised of a two stage power amplifier MMIC. The device includes on-chip ESD protection structures and DC by-pass capacitors to ease the implementation and volume assembly of the packaged part.

The device is specifically designed for use in 7 GHz point-to-point radios for cellular backhaul applications.

### Ordering Information<sup>1</sup>

| Part Number        | Package        |
|--------------------|----------------|
| MAAP-011161        | Bulk Quantity  |
| MAAP-011161-TR0500 | 500 Piece Reel |
| MAAP-011161-001SMB | Sample Board   |

1. Reference Application Note M513 for reel size information.

### Functional Schematic

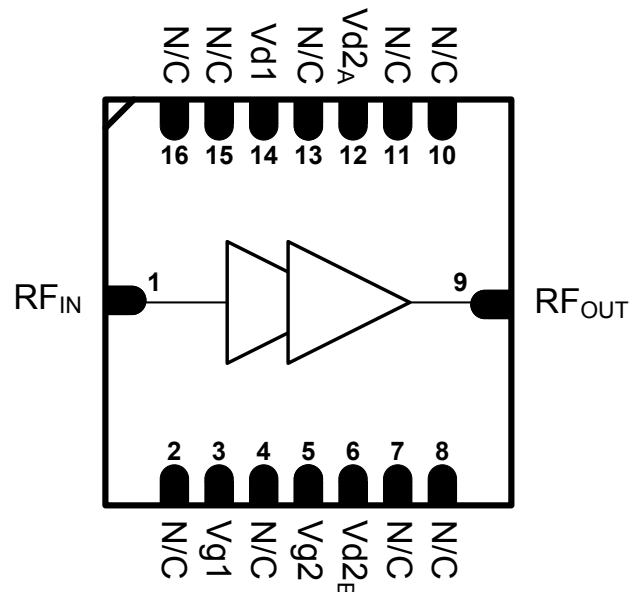

### Pin Configuration<sup>3</sup>

| Pin No.        | Function        | Pin No.         | Function        |
|----------------|-----------------|-----------------|-----------------|
| 1              | RF Input        | 9               | RF Output       |
| 2              | No Connection   | 10              | No Connection   |
| 3              | Gate Stg1 Bias  | 11              | No Connection   |
| 4              | No Connection   | 12 <sup>2</sup> | Drain Stg2 Bias |
| 5              | Gate Stg2 Bias  | 13              | No Connection   |
| 6 <sup>2</sup> | Drain Stg2 Bias | 14              | Drain Stg1 Bias |
| 7              | No Connection   | 15              | No Connection   |
| 8              | No Connection   | 16              | No Connection   |

2. Drain 2 Bias can be connected from either pins 6 or 12
3. The exposed pad centered on the package bottom must be connected to RF and DC ground.

\* Restrictions on Hazardous Substances, European Union Directive 2011/65/EU.

## 4 W Power Amplifier 7.1 - 7.9 GHz

Rev. V1

**Electrical Specifications: Freq. = 7.1 - 7.9 GHz,  $V_D = 8\text{ V}$ ,  $I_{DQ}^4 = 2000\text{ mA}$ ,  $T_A = +25^\circ\text{C}$**

| Parameter                                 | Units | Min. | Typ. | Max. |
|---|-------|------|------|------|
| Small Signal Gain                         | dB    | 18.5 | 22   | 23.5 |
| Input Return Loss                         | dB    | —    | 12   | —    |
| Output Return Loss                        | dB    | 7    | 12   | —    |
| Power at 1dB Gain Compression, P1dB       | dB    | —    | 35.5 | —    |
| Power at 3dB Gain Compression, P3dB       | dBm   | —    | 36   | —    |
| Saturated Output Power, $P_{SAT}$         | dBm   | 35.5 | 36.5 | —    |
| Output IP3, 25.5 dBm SCL @ Freq = 7.5 GHz | dBm   | 44.5 | 46.5 | —    |
| Drain Bias voltage                        | V     | —    | 8.0  | —    |
| Drain Current                             | mA    | —    | 2000 | —    |
| Gate Voltage                              | V     | -1.5 | —    | -0.5 |

4. Adjust  $V_{G1}$  and  $V_{G2}$  between  $-1.2$  and  $-0.7\text{V}$  to achieve specified  $I_{DQ}$  ( $I_{DQ} = I_{D1} + I_{D2}$ ).  $V_{G1}$  and  $V_{G2}$  should be the same voltage.

### Absolute Maximum Ratings<sup>5,6,7</sup>

| Parameter                           | Absolute Max.   |
|-------------------------------------|-----------------|
| Input Power                         | 18 dBm          |
| Drain Voltage ( $V_D$ ,1,2)         | +9 V            |
| Gate Voltage ( $V_G$ ,1,2)          | -3 V            |
| Continuous Power Dissipation @ 85°C | 33.3 W          |
| Junction Temperature (max.)         | +175°C          |
| Junction Temperature                | +150°C          |
| Operating Temperature               | -40°C to +85°C  |
| Storage Temperature                 | -65°C to +150°C |

- Exceeding any one or combination of these limits may cause permanent damage to this device.
- MACOM does not recommend sustained operation near these survivability limits.
- Operating at nominal conditions with  $T_j \leq 150^\circ\text{C}$  will ensure  $MTTF > 1 \times 10^6$  hours. Channel temperature should be kept as low as possible to maximize lifetime.

### Handling Procedures

Please observe the following precautions to avoid damage:

### Static Sensitivity

Gallium Arsenide Integrated Circuits are sensitive to electrostatic discharge (ESD) and can be damaged by static electricity. Proper ESD control techniques should be used when handling these Class 1A HBM devices.

## Recommended PCB Layout

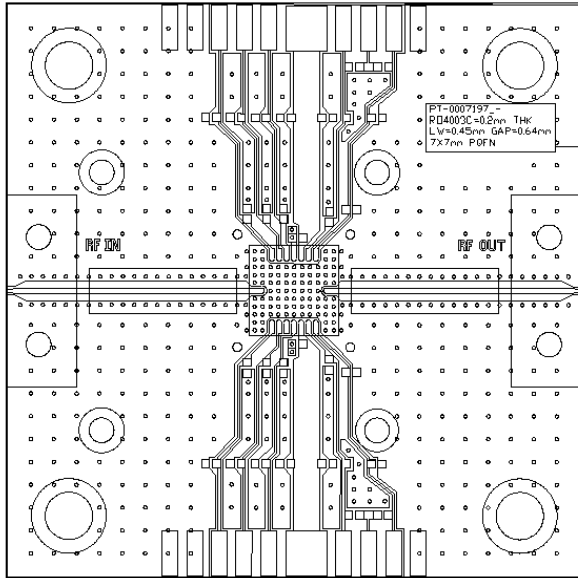

## Schematic

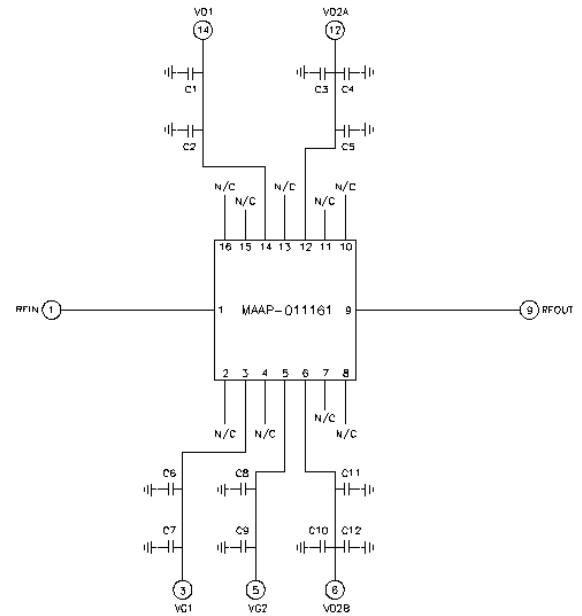

## Parts List

| Component           | Value        | Package |
|---------------------|--------------|---------|
| C1, C4, C7, C9, C12 | 2.2 $\mu$ F  | 0603    |
| C3, C10             | 0.47 $\mu$ F | 0603    |
| C2, C5, C6, C8, C11 | 1.0 nF       | 0603    |

## 4 W Power Amplifier 7.1 - 7.9 GHz

Rev. V1

Typical Performance Curves:  $V_D = 8\text{ V}$ ,  $I_{DQ} = 2\text{ A}$ ,  $V_G = -1.05 \sim -0.95\text{ V}$ ,  $T_A = +25^\circ\text{C}$

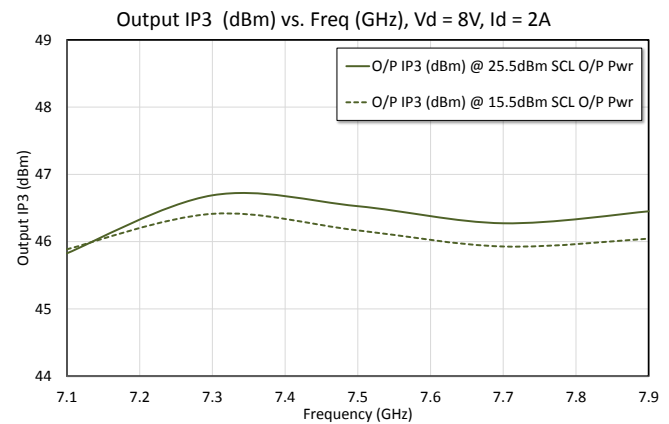
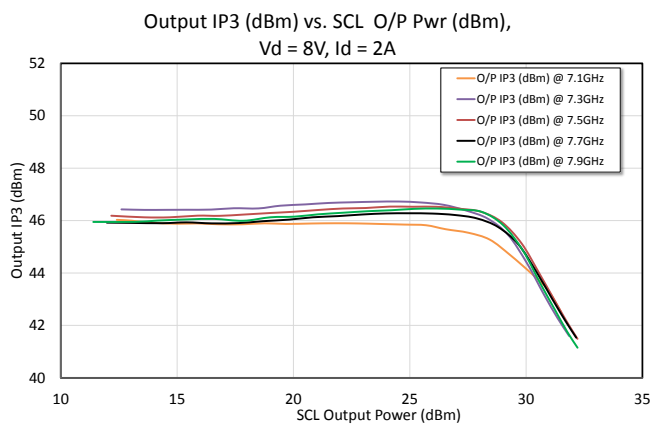
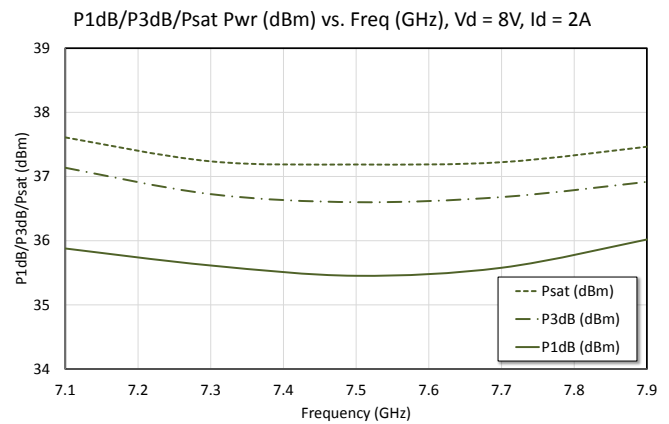
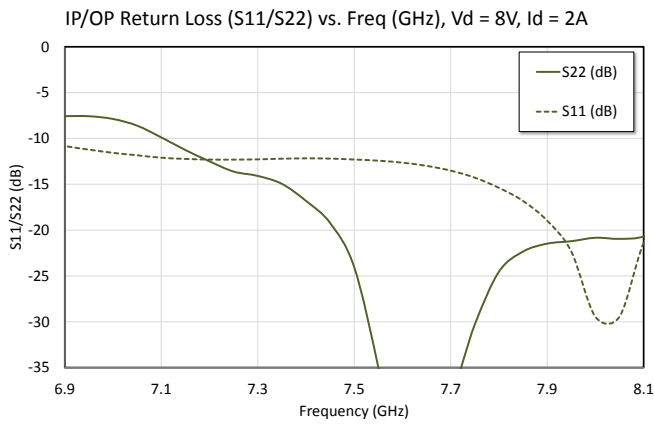
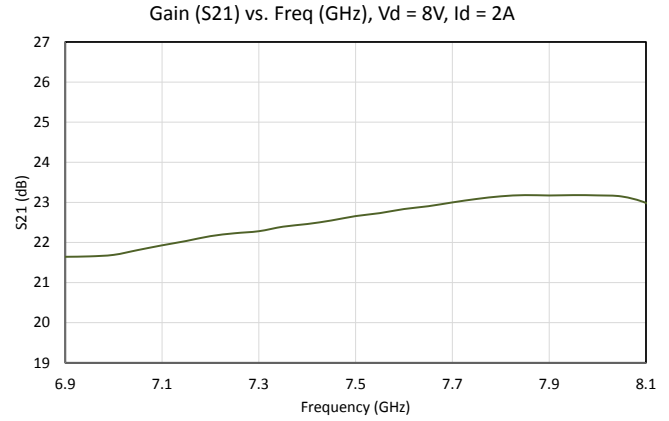
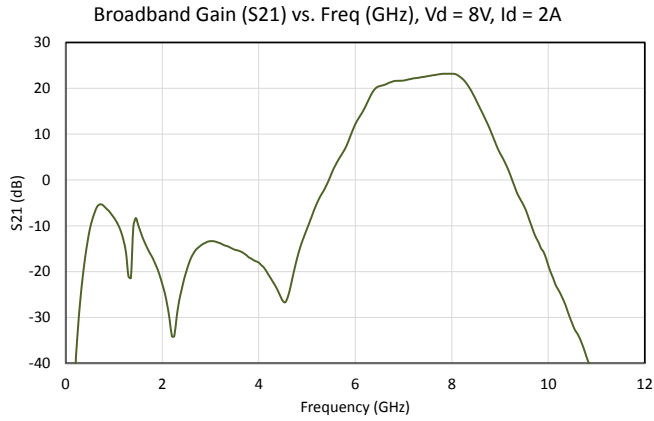

## 4 W Power Amplifier 7.1 - 7.9 GHz

Rev. V1

Typical Performance Curves:  $V_D = 8\text{ V}$ ,  $I_{DQ} = 2\text{ A}$ ,  $V_G = -1.05 \sim -0.95\text{ V}$ ,  $T_A = +25^\circ\text{C}$

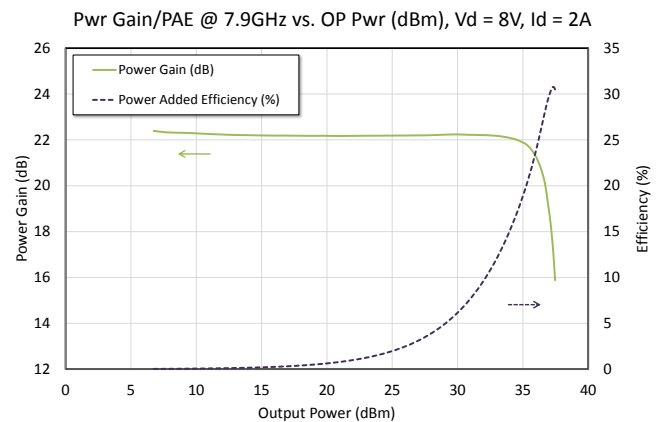
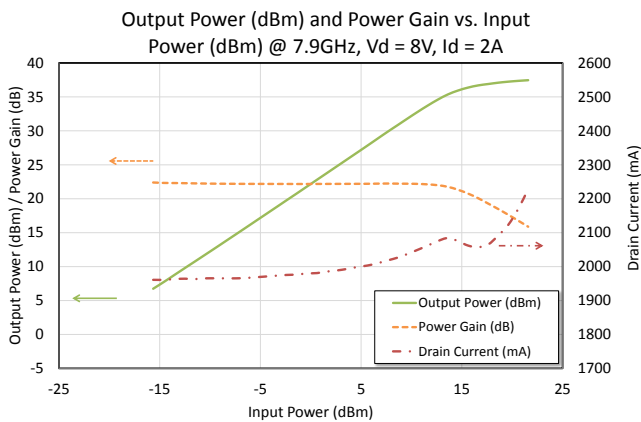
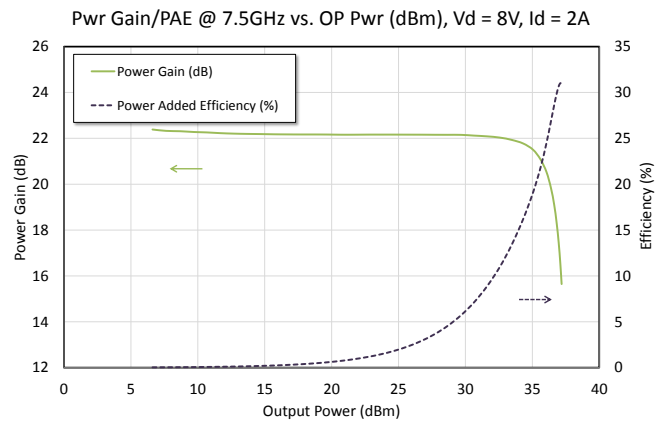
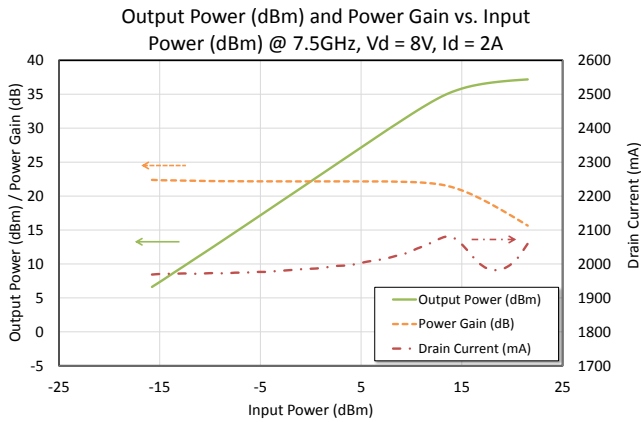
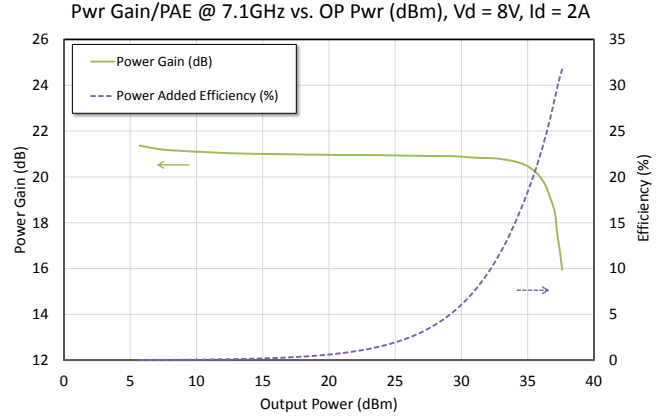
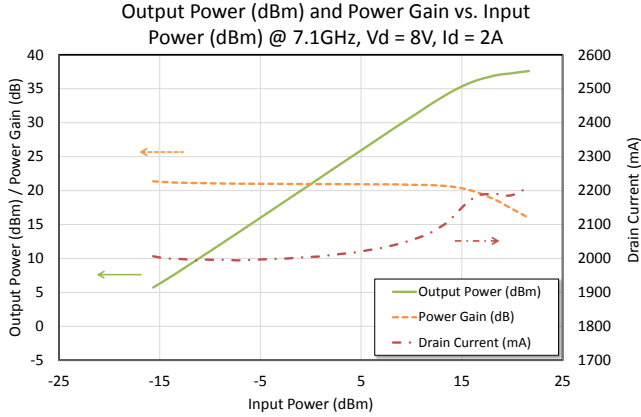

## 4 W Power Amplifier 7.1 - 7.9 GHz

Rev. V1

Typical Performance Curves:  $V_D = 8\text{ V}$ ,  $I_{DQ} = 2\text{ A}$ ,  $V_G = -1.05 \sim -0.95\text{ V}$ ,  $T_A = +25^\circ\text{C}$

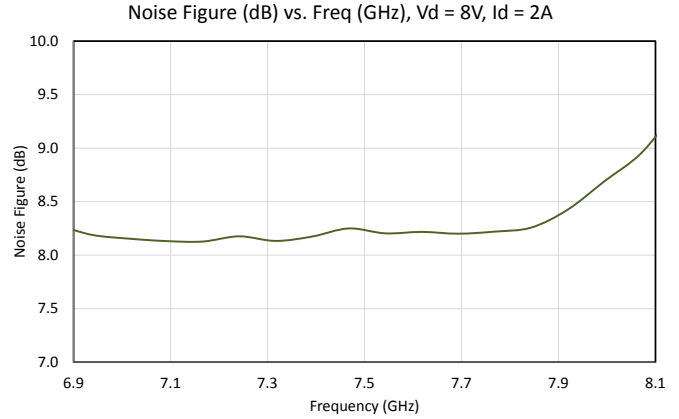
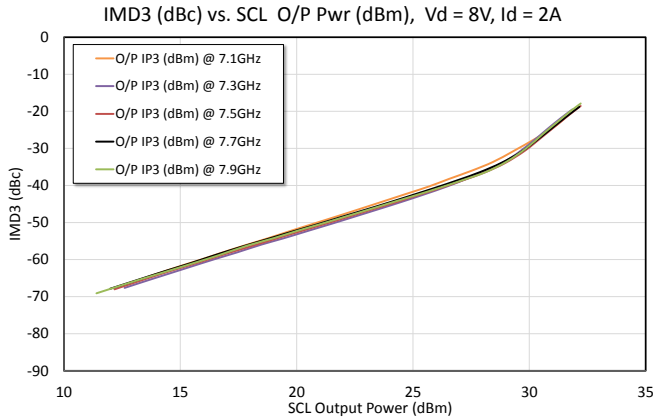

Typical Performance Curves:  $V_D = 8\text{ V}$ ,  $I_{DQ} = 2\text{ A}$ ,  $V_G = -1.05 \sim -0.95\text{ V}$ ,  $T_A = -40^\circ\text{C} \sim +85^\circ\text{C}$

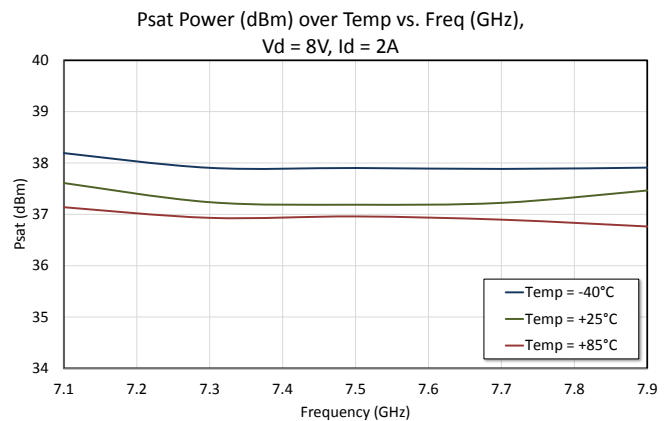
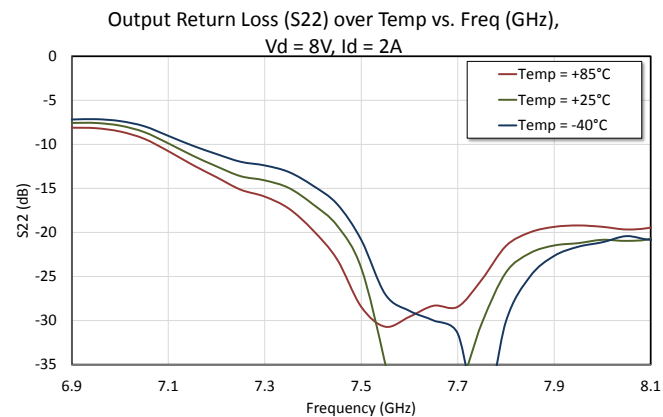
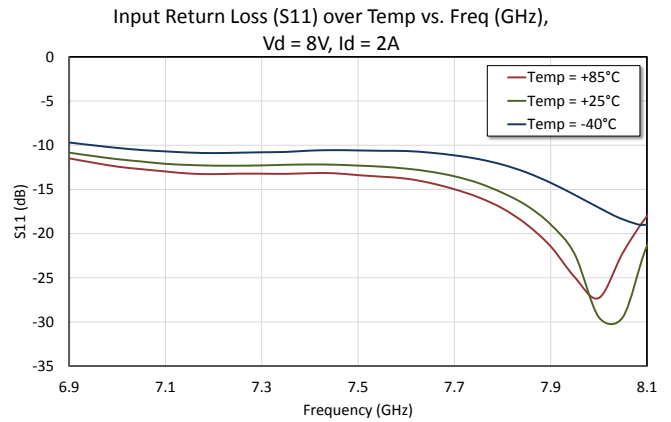
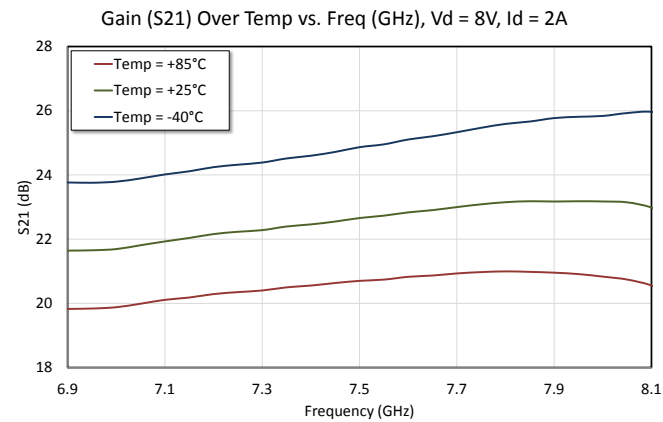

## 4 W Power Amplifier 7.1 - 7.9 GHz

Rev. V1

Typical Performance Curves:  $V_D = 8\text{ V}$ ,  $I_{DQ} = 2\text{ A}$ ,  $V_G = -1.05 \sim -0.95\text{ V}$ ,  $T_A = -40^\circ\text{C} \sim +85^\circ\text{C}$

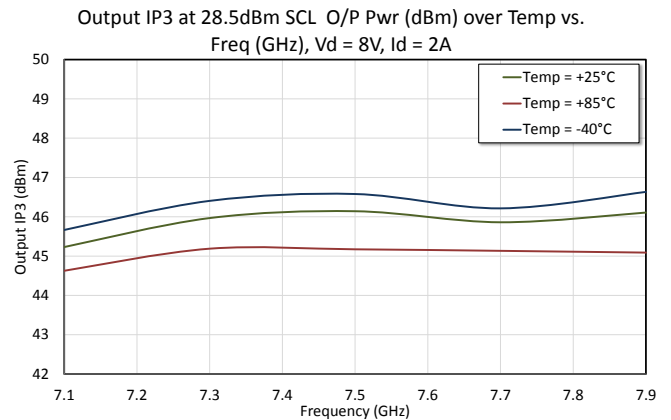
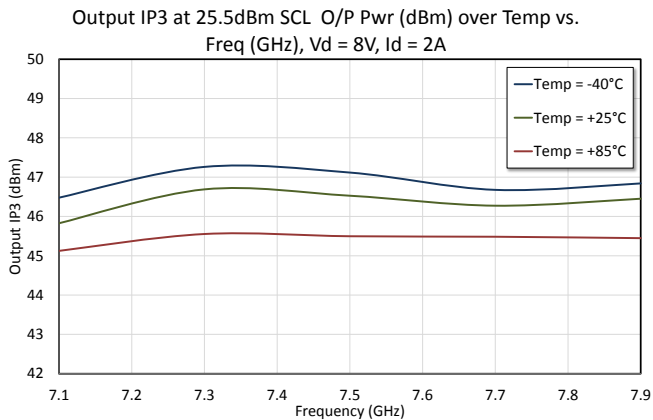
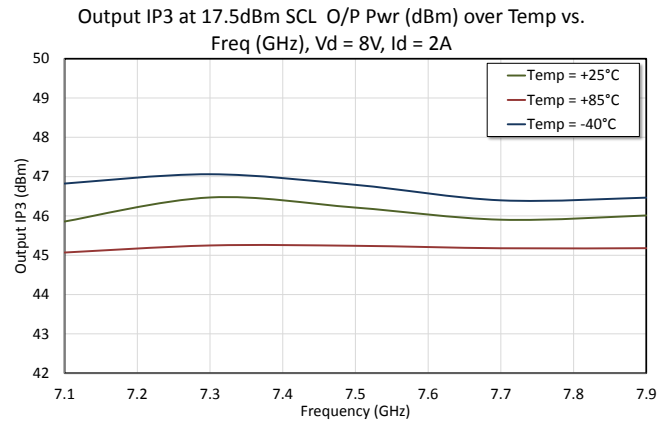
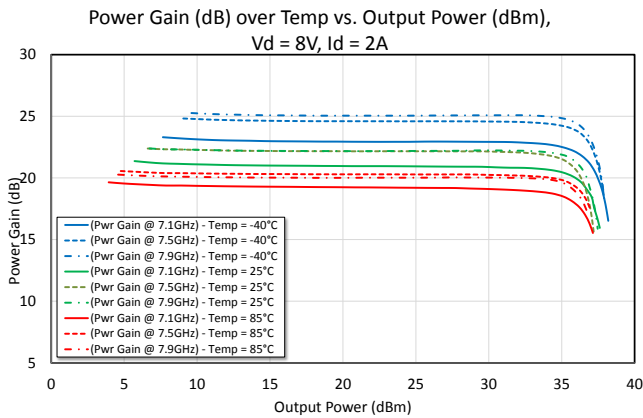
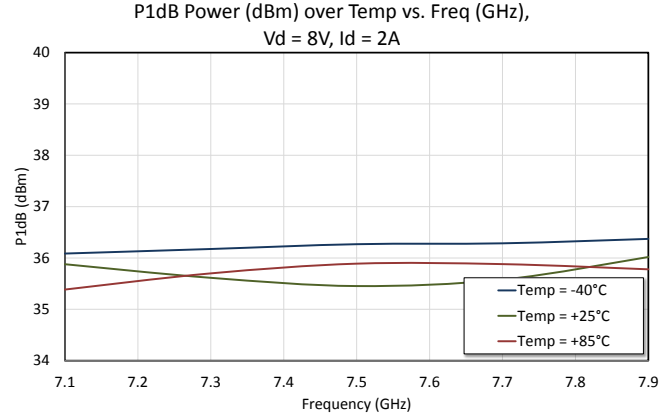
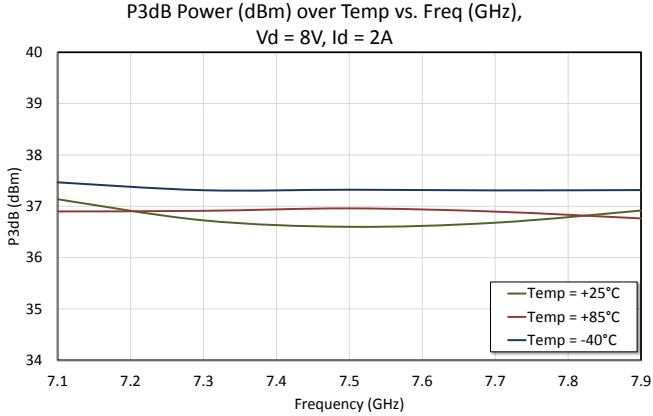

## 4 W Power Amplifier 7.1 - 7.9 GHz

Rev. V1

Typical Performance Curves:  $V_D = \text{Various}$ ,  $I_{DQ} = 2 \text{ A}$ ,  $V_G = -1.05 \sim -0.95 \text{ V}$ ,  $T_A = +25^\circ\text{C}$

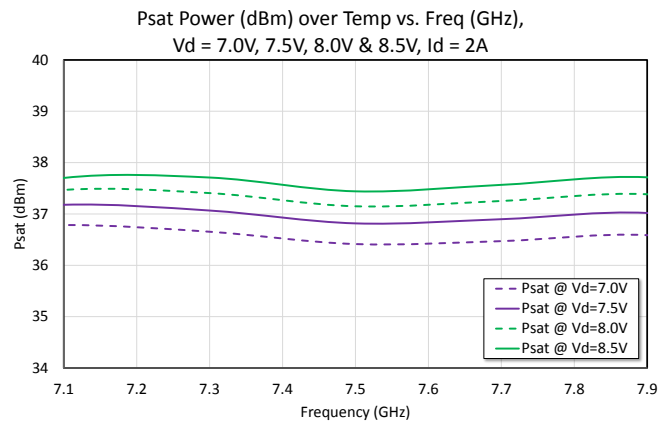
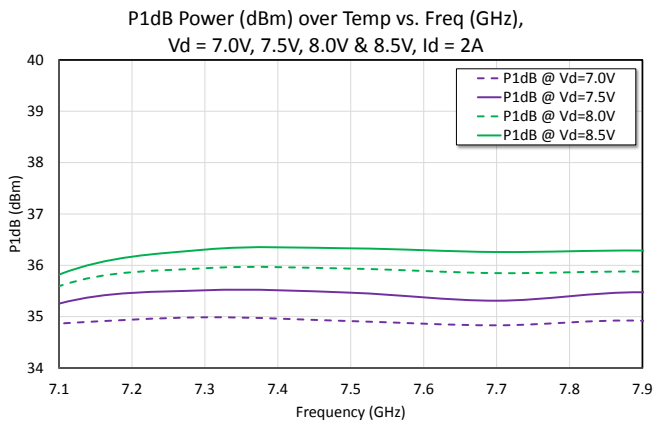
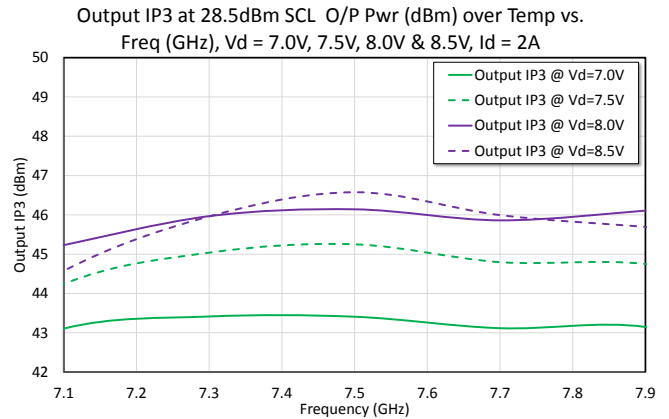
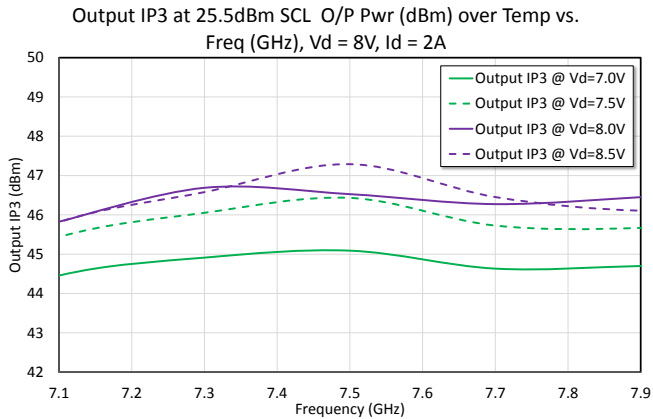

## Typical Performance Curves:

$V_D = \text{Various}$ ,  $I_{DQ} = 1.5 \text{ A}, 1.65 \text{ A}, 2.0 \text{ A}$ ,  $V_G = -1.15 \sim -0.95 \text{ V}$ ,  $T_A = +25^\circ\text{C}$

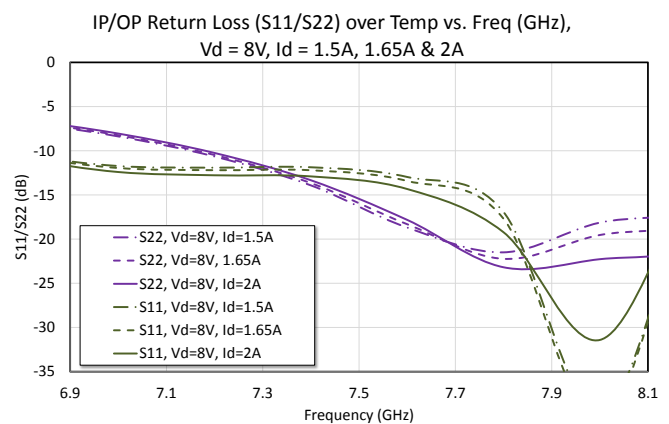
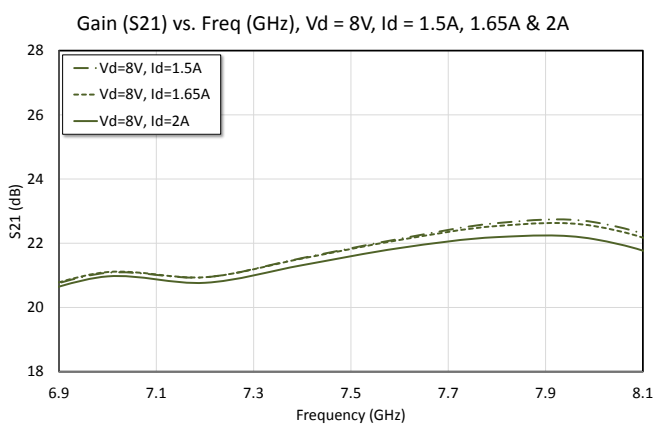



## 4 W Power Amplifier 7.1 - 7.9 GHz

Rev. V1

### Typical Performance Curves:

$V_D = \text{Various}$ ,  $I_{DQ} = 1.5 \text{ A}, 1.65 \text{ A}, 2.0 \text{ A}$ ,  $V_G = -1.15 \sim -0.95 \text{ V}$ ,  $T_A = +25^\circ\text{C}$

Output IP3 at 17.5dBm SCL O/P Pwr (dBm) vs. Freq (GHz),  
 $V_d = 8\text{V}$ ,  $I_d = 1.5\text{A}, 1.65\text{A} \ \& \ 2\text{A}$

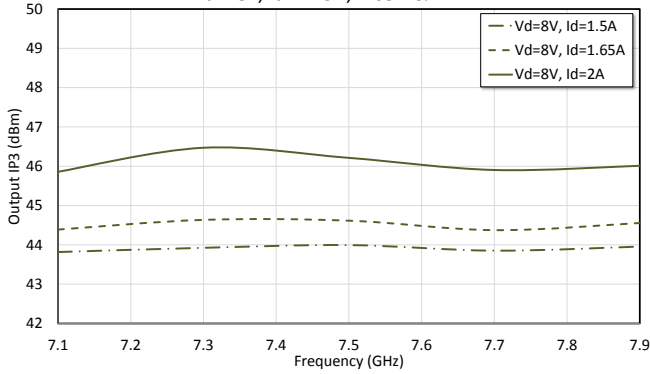

Output IP3 at 25.5dBm SCL O/P Pwr (dBm) vs. Freq (GHz),  
 $V_d = 8\text{V}$ ,  $I_d = 1.5\text{A}, 1.65\text{A} \ \& \ 2\text{A}$

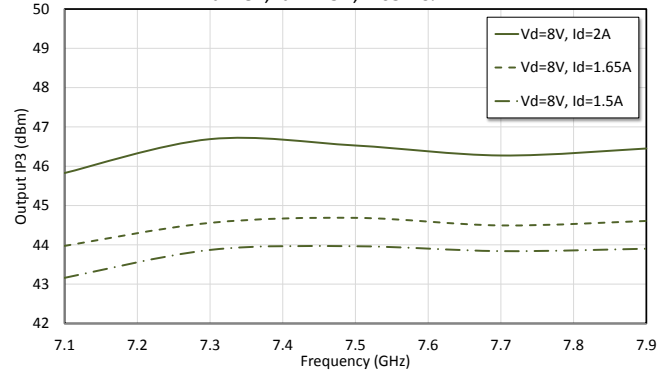

Output IP3 at 28.5dBm SCL O/P Pwr (dBm) vs. Freq (GHz),  
 $V_d = 8\text{V}$ ,  $I_d = 1.5\text{A}, 1.65\text{A} \ \& \ 2\text{A}$

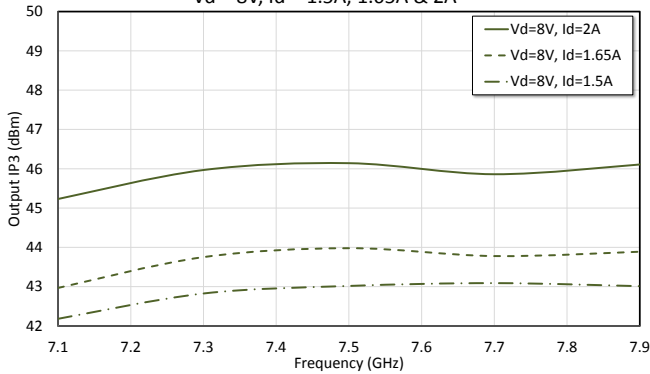

P1dB Power (dBm) vs. Freq (GHz),  
 $V_d = 8\text{V}$ ,  $I_d = 1.5\text{A}, 1.65\text{A} \ \& \ 2\text{A}$

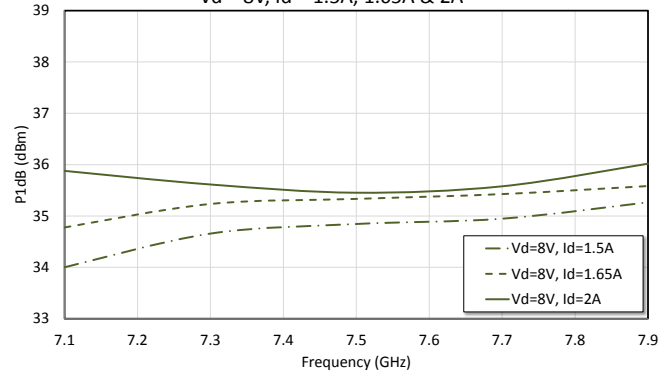

P3dB Power (dBm) vs. Freq (GHz),  
 $V_d = 8\text{V}$ ,  $I_d = 1.5\text{A}, 1.65\text{A} \ \& \ 2\text{A}$

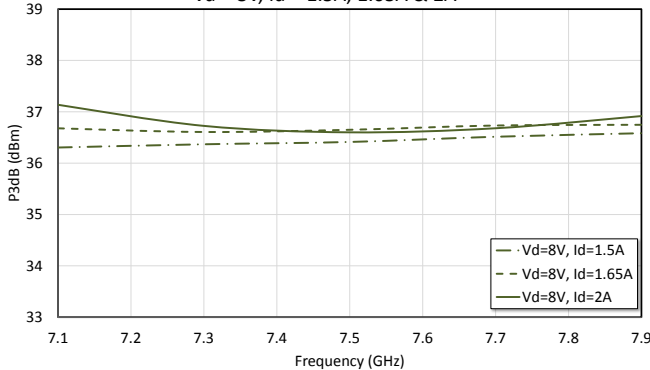

Psat Power (dBm) vs. Freq (GHz),  
 $V_d = 8\text{V}$ ,  $I_d = 1.5\text{A}, 1.65\text{A} \ \& \ 2\text{A}$

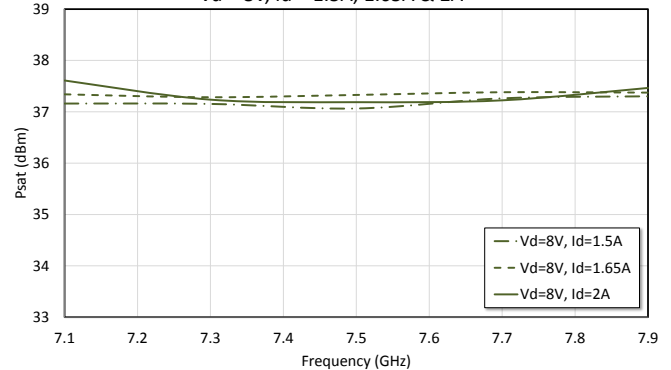

## 4 W Power Amplifier 7.1 - 7.9 GHz

Rev. V1

Typical Performance Curves:  $V_D = 8\text{ V}$ ,  $I_{DQ} = \text{Various}$ ,  $V_G = -0.9 \sim 1.65\text{ V}$ ,  $T_A = +25^\circ\text{C}$

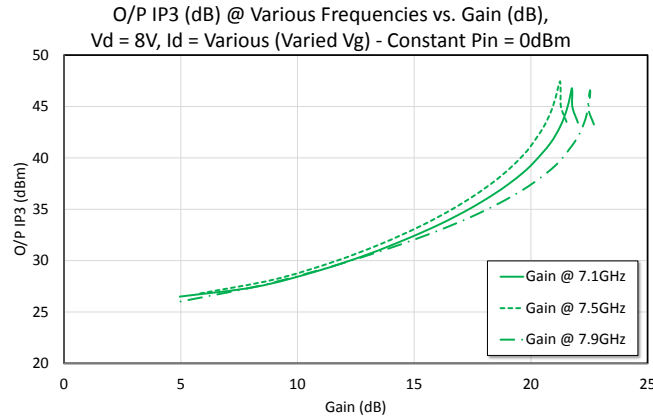
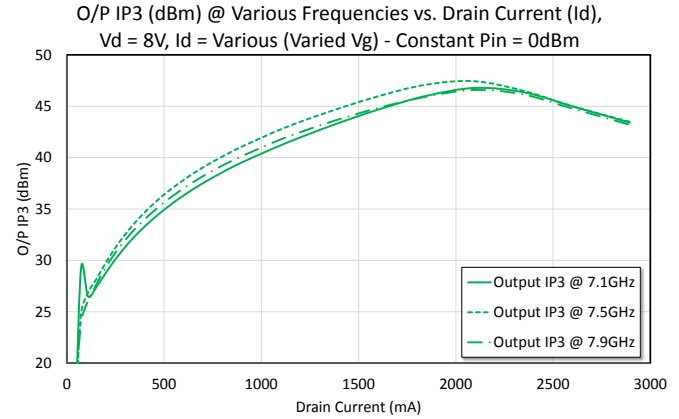
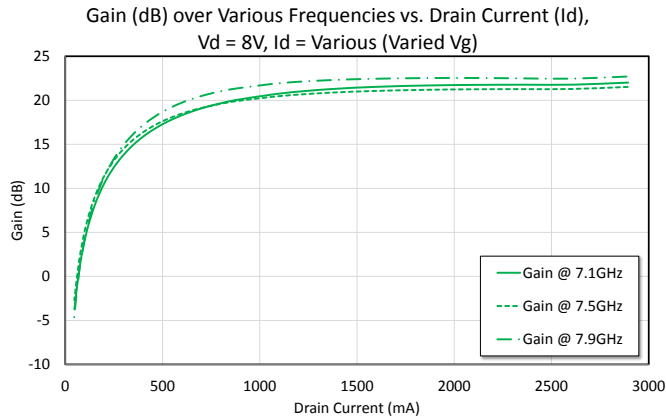

## 4 W Power Amplifier 7.1 - 7.9 GHz

Rev. V1

### Lead Free 7 mm Laminate Package (16 pin)<sup>†</sup>

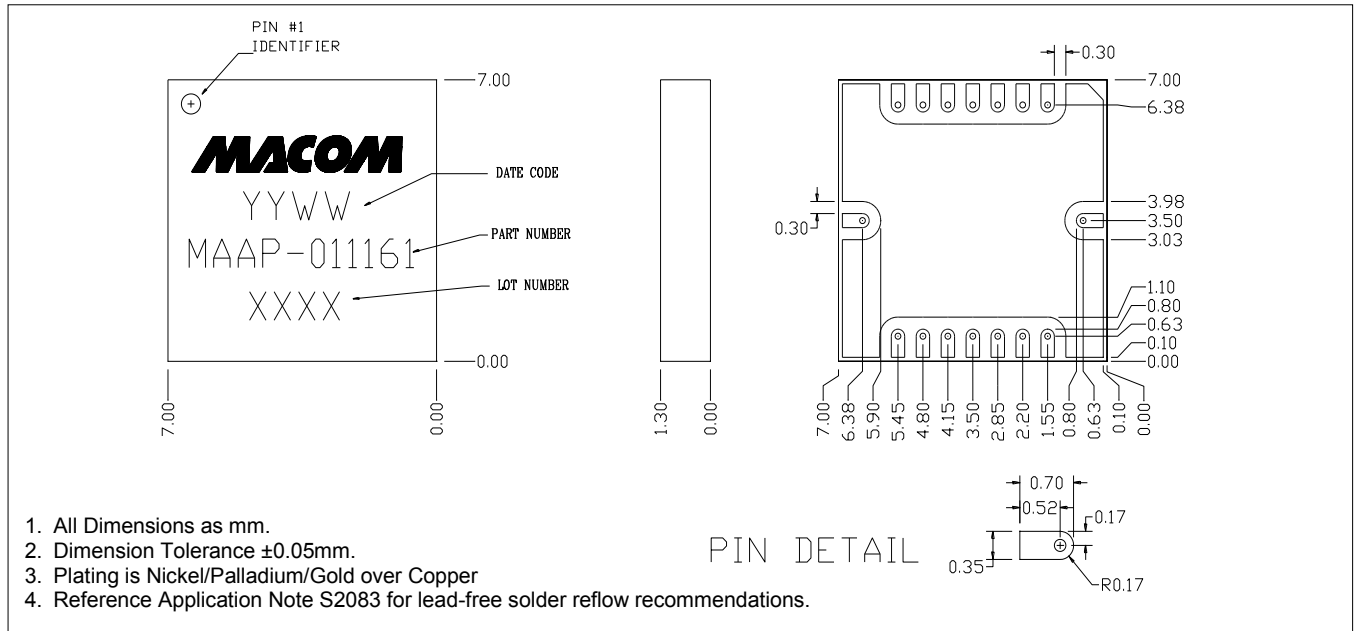

<sup>†</sup> Meets JEDEC moisture sensitivity level 3 requirements.

M/A-COM Technology Solutions Inc. All rights reserved.

Information in this document is provided in connection with M/A-COM Technology Solutions Inc ("MACOM") products. These materials are provided by MACOM as a service to its customers and may be used for informational purposes only. Except as provided in MACOM's Terms and Conditions of Sale for such products or in any separate agreement related to this document, MACOM assumes no liability whatsoever. MACOM assumes no responsibility for errors or omissions in these materials. MACOM may make changes to specifications and product descriptions at any time, without notice. MACOM makes no commitment to update the information and shall have no responsibility whatsoever for conflicts or incompatibilities arising from future changes to its specifications and product descriptions. No license, express or implied, by estoppel or otherwise, to any intellectual property rights is granted by this document.

THESE MATERIALS ARE PROVIDED "AS IS" WITHOUT WARRANTY OF ANY KIND, EITHER EXPRESS OR IMPLIED, RELATING TO SALE AND/OR USE OF MACOM PRODUCTS INCLUDING LIABILITY OR WARRANTIES RELATING TO FITNESS FOR A PARTICULAR PURPOSE, CONSEQUENTIAL OR INCIDENTAL DAMAGES, MERCHANTABILITY, OR INFRINGEMENT OF ANY PATENT, COPYRIGHT OR OTHER INTELLECTUAL PROPERTY RIGHT. MACOM FURTHER DOES NOT WARRANT THE ACCURACY OR COMPLETENESS OF THE INFORMATION, TEXT, GRAPHICS OR OTHER ITEMS CONTAINED WITHIN THESE MATERIALS. MACOM SHALL NOT BE LIABLE FOR ANY SPECIAL, INDIRECT, INCIDENTAL, OR CONSEQUENTIAL DAMAGES, INCLUDING WITHOUT LIMITATION, LOST REVENUES OR LOST PROFITS, WHICH MAY RESULT FROM THE USE OF THESE MATERIALS.

MACOM products are not intended for use in medical, lifesaving or life sustaining applications. MACOM customers using or selling MACOM products for use in such applications do so at their own risk and agree to fully indemnify MACOM for any damages resulting from such improper use or sale.

Компания «Океан Электроники» предлагает заключение долгосрочных отношений при поставках импортных электронных компонентов на взаимовыгодных условиях!

Наши преимущества:

- Поставка оригинальных импортных электронных компонентов напрямую с производств Америки, Европы и Азии, а так же с крупнейших складов мира;
- Широкая линейка поставок активных и пассивных импортных электронных компонентов (более 30 млн. наименований);
- Поставка сложных, дефицитных, либо снятых с производства позиций;
- Оперативные сроки поставки под заказ (от 5 рабочих дней);
- Экспресс доставка в любую точку России;
- Помощь Конструкторского Отдела и консультации квалифицированных инженеров;
- Техническая поддержка проекта, помощь в подборе аналогов, поставка прототипов;
- Поставка электронных компонентов под контролем ВП;
- Система менеджмента качества сертифицирована по Международному стандарту ISO 9001;
- При необходимости вся продукция военного и аэрокосмического назначения проходит испытания и сертификацию в лаборатории (по согласованию с заказчиком);
- Поставка специализированных компонентов военного и аэрокосмического уровня качества (Xilinx, Altera, Analog Devices, Intersil, Interpoint, Microsemi, Actel, Aeroflex, Peregrine, VPT, Syfer, Eurofarad, Texas Instruments, MS Kennedy, Miteq, Cobham, E2V, MA-COM, Hittite, Mini-Circuits, General Dynamics и др.);

Компания «Океан Электроники» является официальным дистрибьютором и эксклюзивным представителем в России одного из крупнейших производителей разъемов военного и аэрокосмического назначения «JONHON», а так же официальным дистрибьютором и эксклюзивным представителем в России производителя высокотехнологичных и надежных решений для передачи СВЧ сигналов «FORSTAR».



## JONHON

«JONHON» (основан в 1970 г.)

Разъемы специального, военного и аэрокосмического назначения:

(Применяются в военной, авиационной, аэрокосмической, морской, железнодорожной, горно- и нефтедобывающей отраслях промышленности)

«FORSTAR» (основан в 1998 г.)

ВЧ соединители, коаксиальные кабели, кабельные сборки и микроволновые компоненты:

(Применяются в телекоммуникациях гражданского и специального назначения, в средствах связи, РЛС, а так же военной, авиационной и аэрокосмической отраслях промышленности).



Телефон: 8 (812) 309-75-97 (многоканальный)

Факс: 8 (812) 320-03-32

Электронная почта: [ocean@oceanchips.ru](mailto:ocean@oceanchips.ru)

Web: <http://oceanchips.ru/>

Адрес: 198099, г. Санкт-Петербург, ул. Калинина, д. 2, корп. 4, лит. А