

Vertical SMT Plug



Series 9159



AVX developed the 9159 Series of SMT connectors for co-planar PCB mating for the challenging Solid State Lighting (SSL) market. These connectors needed to be small, low in height, carry up to 3 Amps/contact and then function up to 125C for extended periods. This application has been very unique to the SSL market where PCB's are stacked end-to-end to create linear strip lighting in everything from office to transportation applications where products are exposed to harsh mechanical and environmental environments.

This vertical plug connector opens up the spectrum to include all commercial, industrial and transportation applications requiring perpendicular PCB mating and latching Wire-to-Board cabled sockets with an already proven connector system. With sizes from 2p-6p, these gold plated contacts mate with high spring force beryllium copper receptacle connectors.

APPLICATIONS

- Allows assembly of PCB's at right angles
- Accepts 24-9159 IDC wired/cabled socket
- Reference application notes 201-01-123
- Reference Product Specification 201-01-119

FEATURES AND BENEFITS

- Single sided SMT RoHS solder attachment;
- Centrally located pick & place cap for easy placement
- Gold plated BeCu contact system for high reliability in harsh environments
- Standard color is white with optional black for specific applications

ELECTRICAL

- Current Rating: 3 Amps / Contact
- Voltage Rating: 125 VAC

ENVIRONMENTAL

- Operating Temperature: -40°C to +125°C

MECHANICAL

- Insulator Material: Nylon: UL94VO
- Contact Material: BeCu / Phos Bronze
- Plating: Gold / Tin over Nickel
- Durability: 10 Cycles

HOW TO ORDER

13

Prefix
Plug -
Vertical
Mount

9159

Series

XXX

Number of Ways

Code	No of Ways	Details
002	2	Page 19
003	3	Page 20
004	4	Page 21
005	5	Page 22
006	6	Page 23

1

2 Part
PCB Strip
Connector

01

Connector
Pitch
01 = 3mm

X

Color Options

Code	Color	Availability
0	Black	Special Order only
1	White	Standard
8	Black	UL Approved - Special Order
9	White	UL Approved - Special Order

16

Plating Option

Code	Contact
16	Gold in Contact Area Tin on Solder Tail
	Bracket
	Tin All Over



Vertical SMT Plug



Series 9159

PLUG – VERTICAL MOUNT 2 WAY 2 PART PCB STRIP CONNECTOR

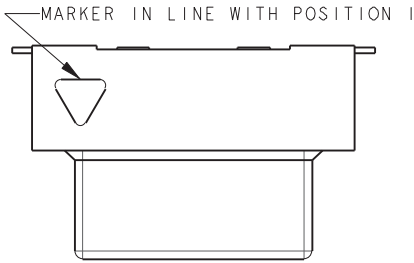

NOTES:

1. FOR FULL PRODUCT SPECIFICATION STANDARD CONNECTORS REFER TO ELCO SPEC 201-01-119, UL COMPONENTS REFER TO ELCO SPEC 201-01-119UL. FOR APPLICATION NOTES REFER TO 201-01-123.
2. GENERAL TOLERANCE ± 0.20 UNLESS TOLERANCED.
3. INSULATOR MATERIAL: NYLON 46, UL94 V-0, COLOR REFER TO PAGE 18.
4. CONTACT MATERIAL: COPPER ALLOY, SELECTIVE GOLD OVER NICKEL, TIN PLATE ON TAILS.
5. BRACKETS; COPPER ALLOY, TIN PLATED.
6. OUTLINE OF CONNECTOR.
7. PACKING IN TAPE AND REEL, QUANTITY PER REEL 700.
8. PICK AND PLACE CAP TO BE REMOVED AFTER USE.
9. OPTIONAL SLOT: ONLY REQUIRED WHEN SOCKET HAS A LATCH, RADIUS ON ENDS OPTIONAL.

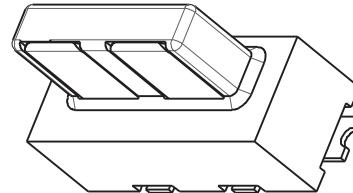
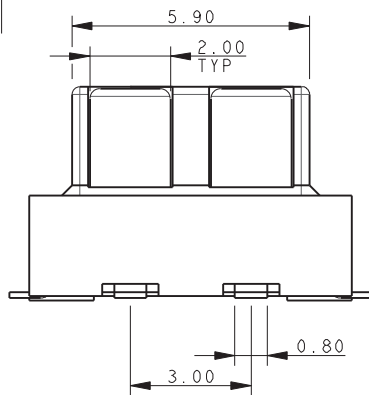
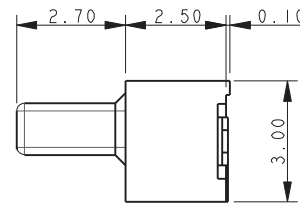
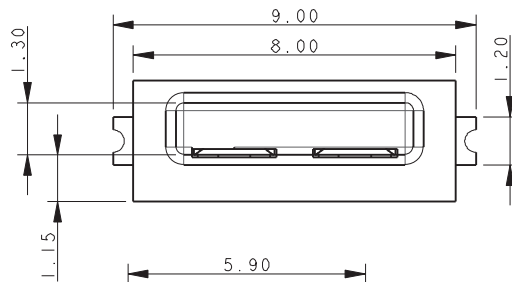

2 WAY PCB BOARD LAYOUT

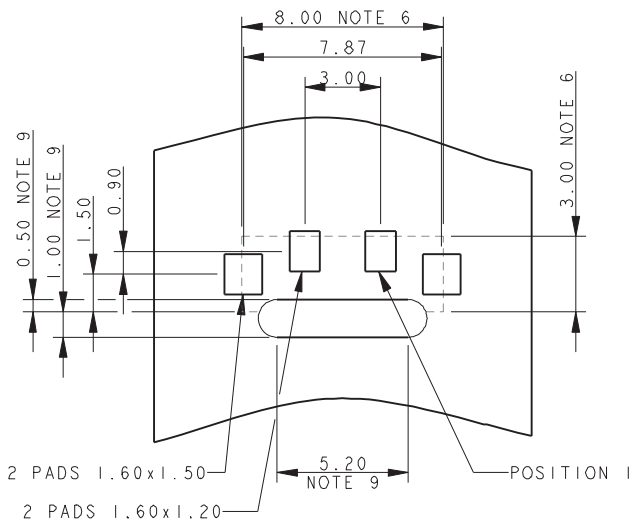

PACKING DETAILS

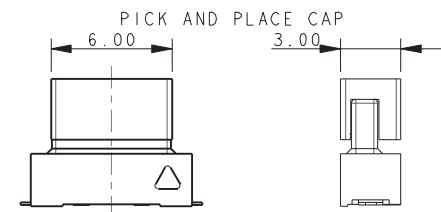

UNREELED DIRECTION

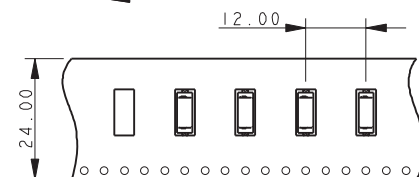

UNREELED DIRECTION



Vertical SMT Plug



Series 9159

PLUG – VERTICAL MOUNT 3 WAY 2 PART PCB STRIP CONNECTOR

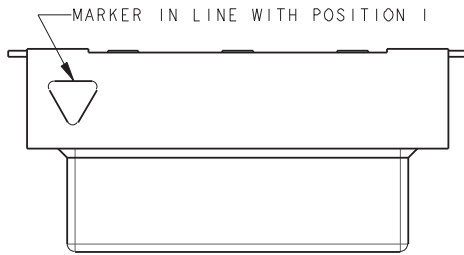

NOTES:

1. FOR FULL PRODUCT SPECIFICATION STANDARD CONNECTORS REFER TO ELCO SPEC 201-01-119, UL COMPONENTS REFER TO ELCO SPEC 201-01-119UL. FOR APPLICATION NOTES REFER TO 201-01-123.
2. GENERAL TOLERANCE ± 0.20 UNLESS TOLERANCED.
3. INSULATOR MATERIAL: NYLON 46, UL94 V-0, COLOR REFER TO PAGE 18.
4. CONTACT MATERIAL: COPPER ALLOY, SELECTIVE GOLD OVER NICKEL, TIN PLATE ON TAILS.
5. BRACKETS: COPPER ALLOY, TIN PLATED.
6. OUTLINE OF CONNECTOR.
7. PACKING IN TAPE AND REEL, QUANTITY PER REEL 700.
8. PICK AND PLACE CAP TO BE REMOVED AFTER USE.
9. OPTIONAL SLOT: ONLY REQUIRED WHEN SOCKET HAS A LATCH, RADIUS ON ENDS OPTIONAL.

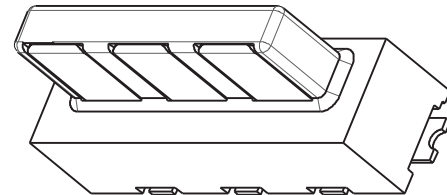
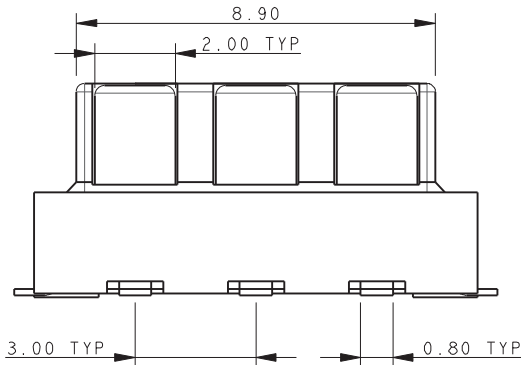
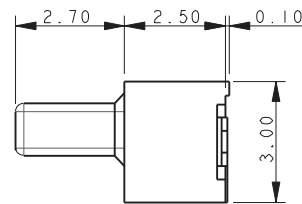
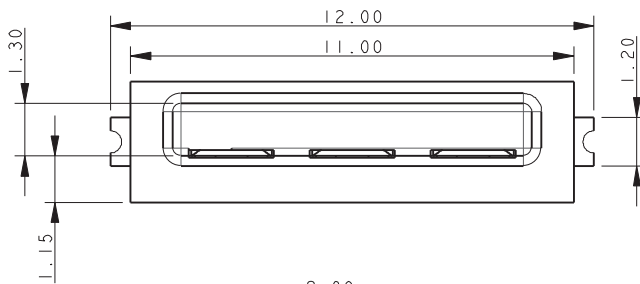

3 WAY PCB BOARD LAYOUT

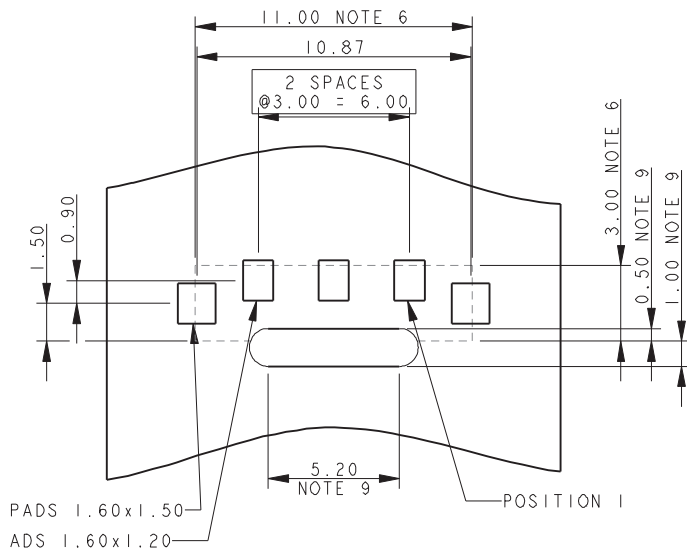

PACKING DETAILS

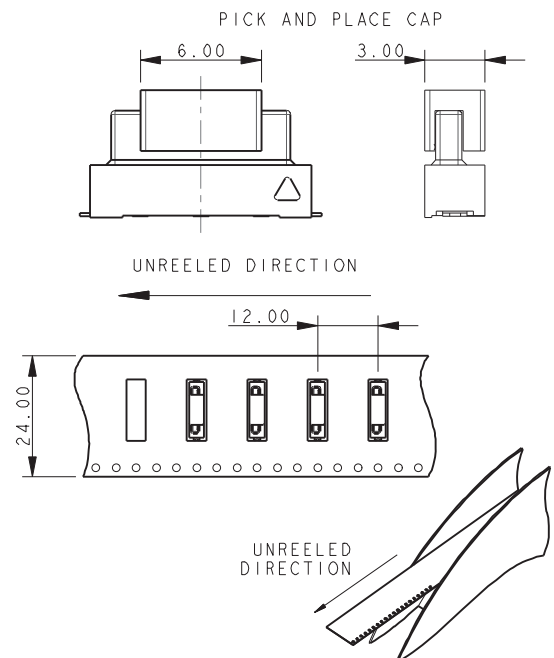

Vertical SMT Plug



Series 9159

PLUG – VERTICAL MOUNT 4 WAY 2 PART PCB STRIP CONNECTOR

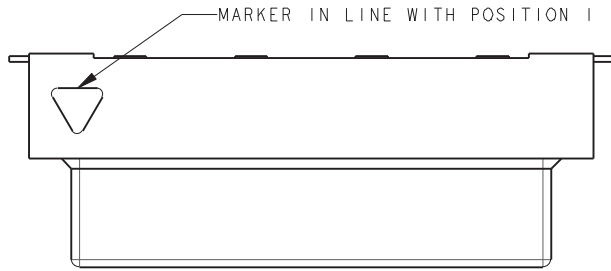

NOTES:

1. FOR FULL PRODUCT SPECIFICATION STANDARD CONNECTORS REFER TO ELCO SPEC 201-01-119, UL COMPONENTS REFER TO ELCO SPEC 201-01-119UL. FOR APPLICATION NOTES REFER TO 201-01-123.
2. GENERAL TOLERANCE ± 0.20 UNLESS TOLERANCED.
3. INSULATOR MATERIAL: NYLON 46, UL94 V-0, COLOR REFER TO PAGE 18.
4. CONTACT MATERIAL: COPPER ALLOY, SELECTIVE GOLD OVER NICKEL, TIN PLATE ON TAILS.
5. BRACKETS; COPPER ALLOY, TIN PLATED.
6. OUTLINE OF CONNECTOR.
7. PACKING IN TAPE AND REEL, QUANTITY PER REEL 700.
8. PICK AND PLACE CAP TO BE REMOVED AFTER USE.
9. OPTIONAL SLOT: ONLY REQUIRED WHEN SOCKET HAS A LATCH, RADIUS ON ENDS OPTIONAL.

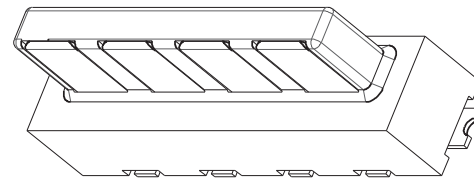
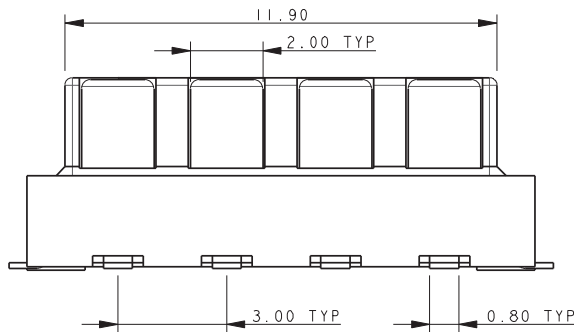
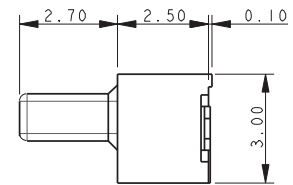
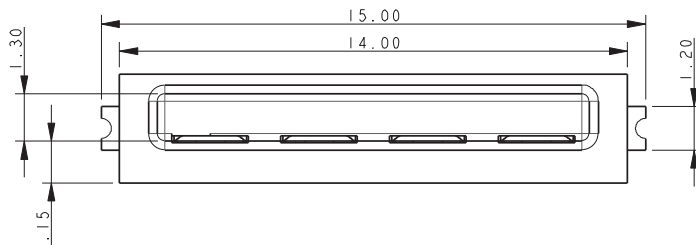

PACKING DETAILS

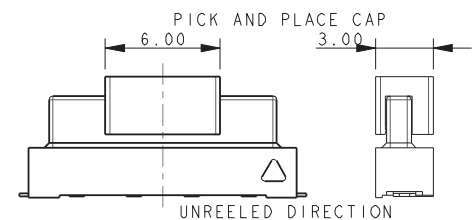

4 WAY PCB BOARD LAYOUT

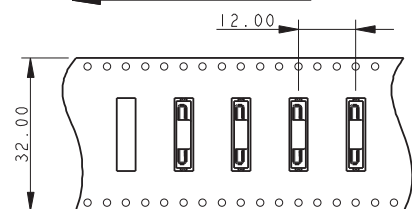
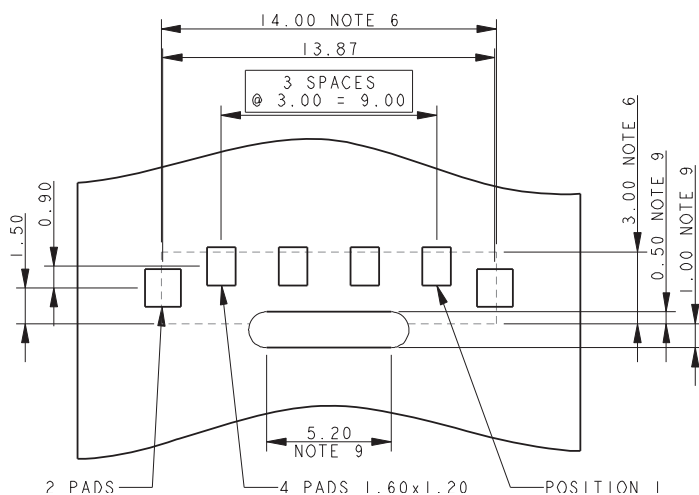

UNREEL DIRECTION



Vertical SMT Plug



Series 9159

PLUG – VERTICAL MOUNT 5 WAY 2 PART PCB STRIP CONNECTOR

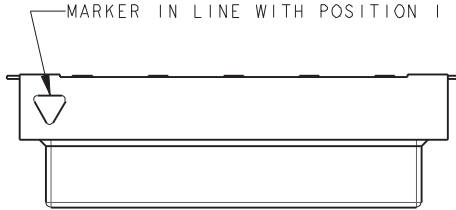

NOTES:

1. FOR FULL PRODUCT SPECIFICATION STANDARD CONNECTORS REFER TO ELCO SPEC 201-01-119, UL COMPONENTS REFER TO ELCO SPEC 201-01-119UL. FOR APPLICATION NOTES REFER TO 201-01-123.
2. GENERAL TOLERANCE ± 0.20 UNLESS TOLERANCED.
3. INSULATOR MATERIAL: NYLON 46, UL94 V-0, COLOR REFER TO PAGE 18.
4. CONTACT MATERIAL: COPPER ALLOY, SELECTIVE GOLD OVER NICKEL, TIN PLATE ON TAILS.
5. BRACKETS; COPPER ALLOY, TIN PLATED.
6. OUTLINE OF CONNECTOR.
7. PACKING IN TAPE AND REEL, QUANTITY PER REEL 700.
8. PICK AND PLACE CAP TO BE REMOVED AFTER USE.
9. OPTIONAL SLOT: ONLY REQUIRED WHEN SOCKET HAS A LATCH, RADIUS ON ENDS OPTIONAL.

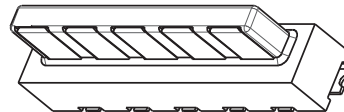
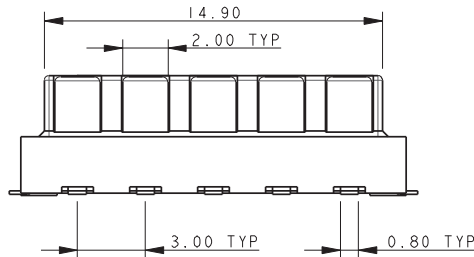
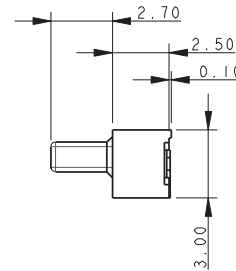
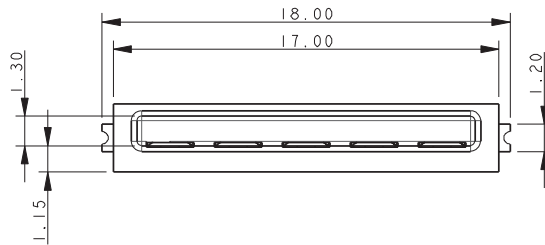

5 WAY PCB BOARD LAYOUT

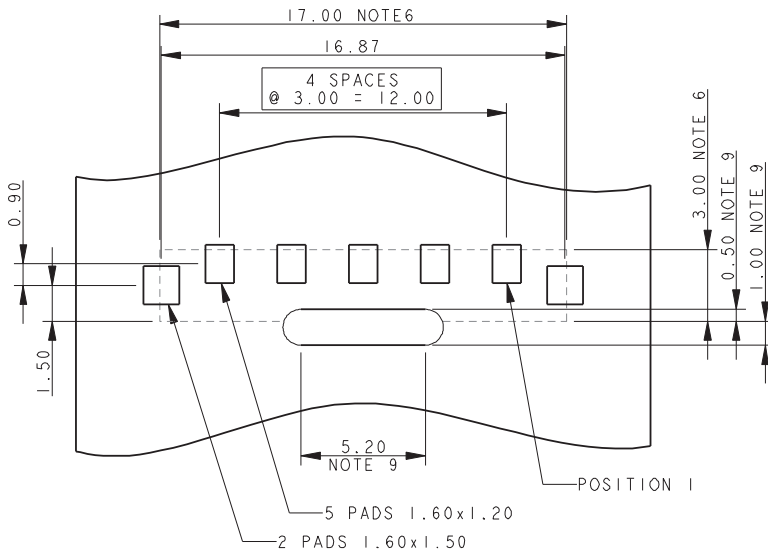

PACKING DETAILS

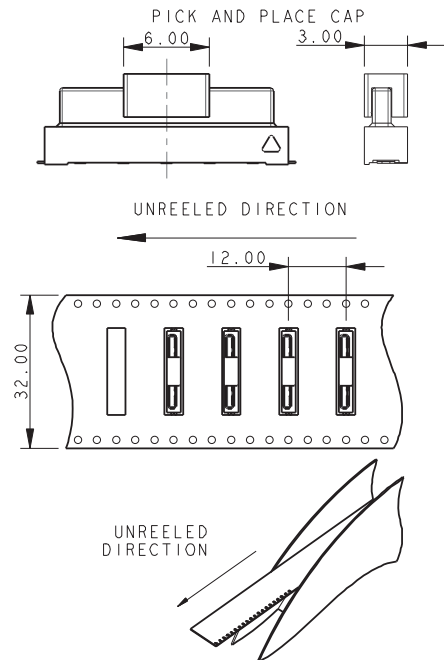

Vertical SMT Plug



Series 9159

PLUG – VERTICAL MOUNT 6 WAY 2 PART PCB STRIP CONNECTOR

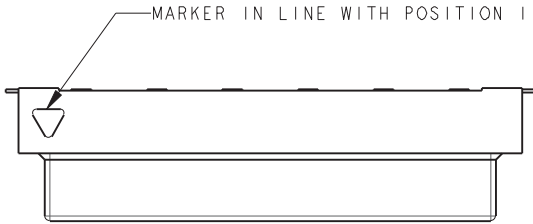

NOTES:

1. FOR FULL PRODUCT SPECIFICATION STANDARD CONNECTORS REFER TO ELCO SPEC 201-01-119, UL COMPONENTS REFER TO ELCO SPEC 201-01-119UL. FOR APPLICATION NOTES REFER TO 201-01-123.
2. GENERAL TOLERANCE ± 0.20 UNLESS TOLERANCED.
3. INSULATOR MATERIAL: NYLON 46, UL94 V-0, COLOR REFER TO PAGE 18.
4. CONTACT MATERIAL: COPPER ALLOY, SELECTIVE GOLD OVER NICKEL, TIN PLATE ON TAILS.
5. BRACKETS; COPPER ALLOY, TIN PLATED.
6. OUTLINE OF CONNECTOR.
7. PACKING IN TAPE AND REEL, QUANTITY PER REEL 700.
8. PICK AND PLACE CAP TO BE REMOVED AFTER USE.
9. OPTIONAL SLOT: ONLY REQUIRED WHEN SOCKET HAS A LATCH, RADIUS ON ENDS OPTIONAL.

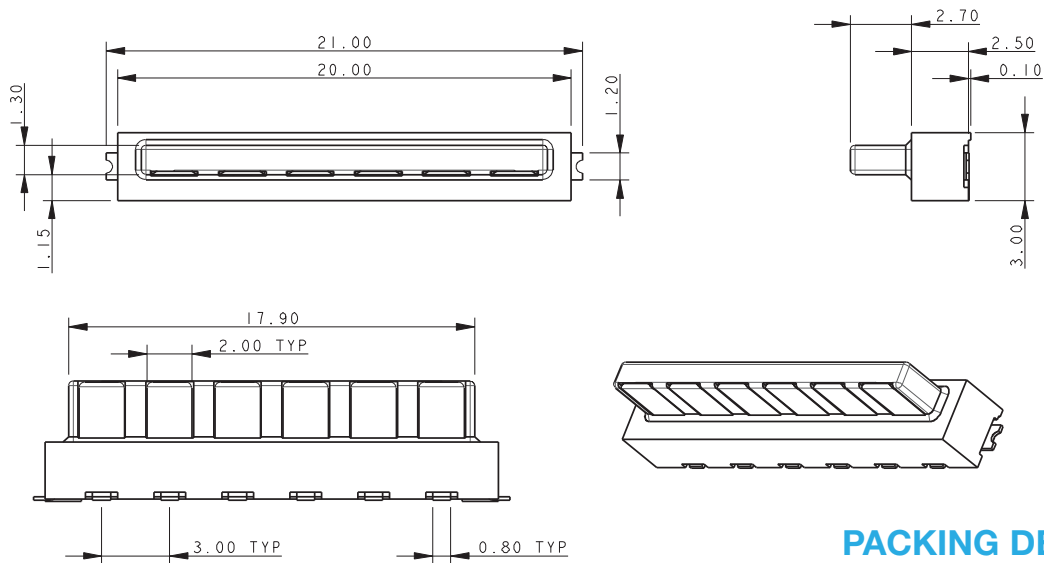

6 WAY PCB BOARD LAYOUT

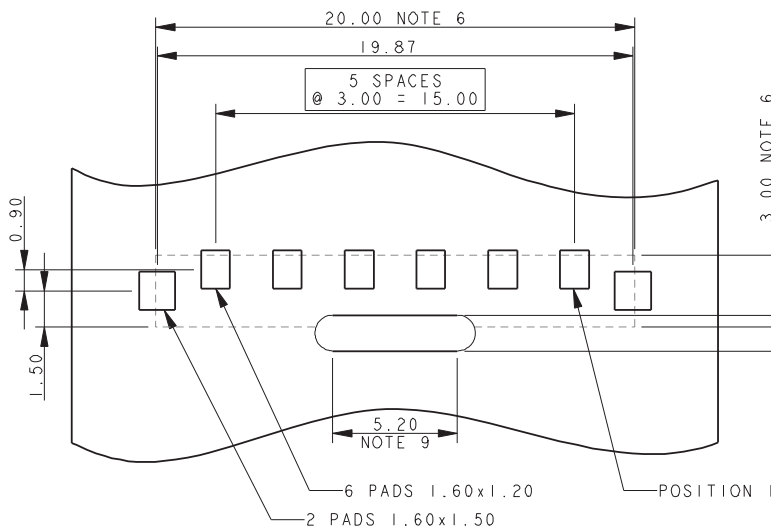

PACKING DETAILS

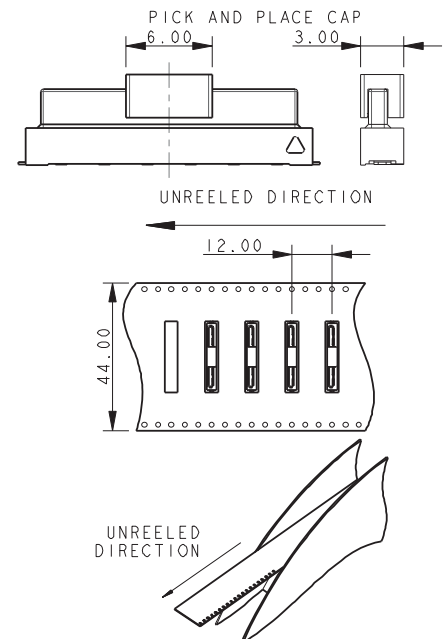

Компания «Океан Электроники» предлагает заключение долгосрочных отношений при поставках импортных электронных компонентов на взаимовыгодных условиях!

Наши преимущества:

- Поставка оригинальных импортных электронных компонентов напрямую с производств Америки, Европы и Азии, а так же с крупнейших складов мира;
- Широкая линейка поставок активных и пассивных импортных электронных компонентов (более 30 млн. наименований);
- Поставка сложных, дефицитных, либо снятых с производства позиций;
- Оперативные сроки поставки под заказ (от 5 рабочих дней);
- Экспресс доставка в любую точку России;
- Помощь Конструкторского Отдела и консультации квалифицированных инженеров;
- Техническая поддержка проекта, помощь в подборе аналогов, поставка прототипов;
- Поставка электронных компонентов под контролем ВП;
- Система менеджмента качества сертифицирована по Международному стандарту ISO 9001;
- При необходимости вся продукция военного и аэрокосмического назначения проходит испытания и сертификацию в лаборатории (по согласованию с заказчиком);
- Поставка специализированных компонентов военного и аэрокосмического уровня качества (Xilinx, Altera, Analog Devices, Intersil, Interpoint, Microsemi, Actel, Aeroflex, Peregrine, VPT, Syfer, Eurofarad, Texas Instruments, MS Kennedy, Miteq, Cobham, E2V, MA-COM, Hittite, Mini-Circuits, General Dynamics и др.);

Компания «Океан Электроники» является официальным дистрибьютором и эксклюзивным представителем в России одного из крупнейших производителей разъемов военного и аэрокосмического назначения «JONHON», а так же официальным дистрибьютором и эксклюзивным представителем в России производителя высокотехнологичных и надежных решений для передачи СВЧ сигналов «FORSTAR».



JONHON

«JONHON» (основан в 1970 г.)

Разъемы специального, военного и аэрокосмического назначения:

(Применяются в военной, авиационной, аэрокосмической, морской, железнодорожной, горно- и нефтедобывающей отраслях промышленности)

«FORSTAR» (основан в 1998 г.)

ВЧ соединители, коаксиальные кабели, кабельные сборки и микроволновые компоненты:

(Применяются в телекоммуникациях гражданского и специального назначения, в средствах связи, РЛС, а так же военной, авиационной и аэрокосмической отраслях промышленности).



Телефон: 8 (812) 309-75-97 (многоканальный)

Факс: 8 (812) 320-03-32

Электронная почта: ocean@oceanchips.ru

Web: <http://oceanchips.ru/>

Адрес: 198099, г. Санкт-Петербург, ул. Калинина, д. 2, корп. 4, лит. А