

# DTC114EET1 Series, SDTC114EET1 Series



ON Semiconductor®

<http://onsemi.com>

## Bias Resistor Transistor NPN Silicon Surface Mount Transistor with Monolithic Bias Resistor Network

This new series of digital transistors is designed to replace a single device and its external resistor bias network. The BRT (Bias Resistor Transistor) contains a single transistor with a monolithic bias network consisting of two resistors; a series base resistor and a base-emitter resistor. The BRT eliminates these individual components by integrating them into a single device. The use of a BRT can reduce both system cost and board space. The device is housed in the SC-75/SOT-416 package which is designed for low power surface mount applications.

### Features

- Simplifies Circuit Design
- Reduces Board Space
- Reduces Component Count
- The SC-75/SOT-416 Package Can be Soldered Using Wave or Reflow
- The Modified Gull-Winged Leads Absorb Thermal Stress During Soldering Eliminating the Possibility of Damage to the Die
- Pb-Free Packages are Available
- S Prefix for Automotive and Other Applications Requiring Unique Site and Control Change Requirements; AEC-Q101 Qualified and PPAP Capable

### MAXIMUM RATINGS (T<sub>A</sub> = 25°C unless otherwise noted)

Rating	Symbol	Value	Unit
Collector-Base Voltage	V <sub>CBO</sub>	50	Vdc
Collector-Emitter Voltage	V <sub>CEO</sub>	50	Vdc
Collector Current	I <sub>C</sub>	100	mAdc

### THERMAL CHARACTERISTICS

Rating	Symbol	Value	Unit
Total Device Dissipation, FR-4 Board (Note 1) @ T <sub>A</sub> = 25°C Derate above 25°C	P <sub>D</sub>	200 1.6	mW mW/°C
Thermal Resistance, Junction-to-Ambient (Note 1)	R <sub>θJA</sub>	600	°C/W
Total Device Dissipation, FR-4 Board (Note 2) @ T <sub>A</sub> = 25°C Derate above 25°C	P <sub>D</sub>	300 2.4	mW mW/°C
Thermal Resistance, Junction-to-Ambient (Note 2)	R <sub>θJA</sub>	400	°C/W
Junction and Storage Temperature Range	T <sub>J</sub> , T <sub>stg</sub>	-55 to +150	°C

Stresses exceeding Maximum Ratings may damage the device. Maximum Ratings are stress ratings only. Functional operation above the Recommended Operating Conditions is not implied. Extended exposure to stresses above the Recommended Operating Conditions may affect device reliability.

1. FR-4 @ Minimum Pad
2. FR-4 @ 1.0 × 1.0 Inch Pad

## NPN SILICON BIAS RESISTOR TRANSISTORS

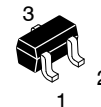
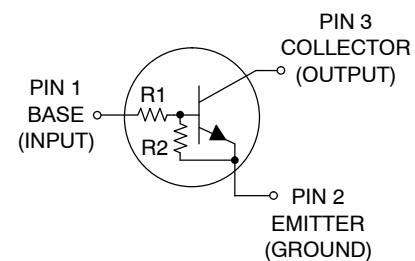

SC-75 (SOT-416)  
CASE 463  
STYLE 1

### MARKING DIAGRAM

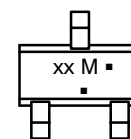

- xx = Specific Device Code  
xx = (Refer to page 2)
- M = Date Code\*
- = Pb-Free Package

(Note: Microdot may be in either location)

\*Date Code orientation may vary depending upon manufacturing location.

### ORDERING INFORMATION

See detailed ordering, marking, and shipping information in the package dimensions section on page 2 of this data sheet.

## DTC114EET1 Series, SDTC114EET1 Series

### ORDERING INFORMATION, DEVICE MARKING and RESISTOR VALUES

Device	Marking	R1 (K)	R2 (K)	Package	Shipping†
DTC114EET1	8A	10	10	SC-75/SOT-416	3000 Tape & Reel
DTC114EET1G				SC-75/SOT-416 (Pb-Free)	3000 Tape & Reel
SDTC114EET1G					
DTC124EET1	8B	22	22	SC-75/SOT-416	3000 Tape & Reel
DTC124EET1G				SC-75/SOT-416 (Pb-Free)	3000 Tape & Reel
SDTC124EET1G					
DTC144EET1	8C	47	47	SC-75/SOT-416	3000 Tape & Reel
DTC144EET1G				SC-75/SOT-416 (Pb-Free)	3000 Tape & Reel
DTC114YET1	8D	10	47	SC-75/SOT-416	3000 Tape & Reel
DTC114YET1G				SC-75/SOT-416 (Pb-Free)	3000 Tape & Reel
SDTC114YET1G					
DTC114TET1	94	10	∞	SC-75/SOT-416	3000 Tape & Reel
DTC114TET1G				SC-75/SOT-416 (Pb-Free)	3000 Tape & Reel
DTC143TET1	8F	4.7	∞	SC-75/SOT-416	3000 Tape & Reel
DTC143TET1G				SC-75/SOT-416 (Pb-Free)	3000 Tape & Reel
DTC123EET1	8H	2.2	2.2	SC-75/SOT-416	3000 Tape & Reel
DTC123EET1G				SC-75/SOT-416 (Pb-Free)	3000 Tape & Reel
DTC143EET1	8J	4.7	4.7	SC-75/SOT-416	3000 Tape & Reel
DTC143EET1G				SC-75/SOT-416 (Pb-Free)	3000 Tape & Reel
DTC143ZET1	8K	4.7	47	SC-75/SOT-416	3000 Tape & Reel
DTC143ZET1G				SC-75/SOT-416 (Pb-Free)	3000 Tape & Reel
DTC124XET1	8L	22	47	SC-75/SOT-416	3000 Tape & Reel
DTC124XET1G				SC-75/SOT-416 (Pb-Free)	3000 Tape & Reel
DTC123JET1	8M	2.2	47	SC-75/SOT-416	3000 Tape & Reel
DTC123JET1G				SC-75/SOT-416 (Pb-Free)	3000 Tape & Reel
DTC115EET1	8N	100	100	SC-75/SOT-416	3000 Tape & Reel
DTC115EET1G				SC-75/SOT-416 (Pb-Free)	3000 Tape & Reel
DTC144WET1	8P	47	22	SC-75/SOT-416	3000 Tape & Reel
DTC144WET1G				SC-75/SOT-416	3000 Tape & Reel

†For information on tape and reel specifications, including part orientation and tape sizes, please refer to our Tape and Reel Packaging Specifications Brochure, BRD8011/D.

## DTC114EET1 Series, SDTC114EET1 Series

### ELECTRICAL CHARACTERISTICS ( $T_A = 25^\circ\text{C}$ unless otherwise noted)

Characteristic	Symbol	Min	Typ	Max	Unit
<b>OFF CHARACTERISTICS</b>					
Collector–Base Cutoff Current ( $V_{CB} = 50\text{ V}$ , $I_E = 0$ )	$I_{CBO}$	–	–	100	nAdc
Collector–Emitter Cutoff Current ( $V_{CE} = 50\text{ V}$ , $I_B = 0$ )	$I_{CEO}$	–	–	500	nAdc
Emitter–Base Cutoff Current ( $V_{EB} = 6.0\text{ V}$ , $I_C = 0$ )	$I_{EBO}$	–	–	0.5	mAdc
DTC114EET1, SDTC114EET1		–	–	0.2	
DTC124EET1, SDTC124EET1		–	–	0.1	
DTC144EET1		–	–	0.2	
DTC114YET1, SDTC114YET1		–	–	0.9	
DTC114TET1		–	–	1.9	
DTC143TET1		–	–	2.3	
DTC123EET1		–	–	1.5	
DTC143EET1		–	–	0.18	
DTC143ZET1		–	–	0.13	
DTC124XET1		–	–	0.2	
DTC123JET1		–	–	0.05	
DTC115EET1		–	–	0.13	
DTC144WET1		–	–		
Collector–Base Breakdown Voltage ( $I_C = 10\ \mu\text{A}$ , $I_E = 0$ )	$V_{(BR)CBO}$	50	–	–	Vdc
Collector–Emitter Breakdown Voltage (Note 3) ( $I_C = 2.0\text{ mA}$ , $I_B = 0$ )	$V_{(BR)CEO}$	50	–	–	Vdc
<b>ON CHARACTERISTICS (Note 3)</b>					
DC Current Gain ( $V_{CE} = 10\text{ V}$ , $I_C = 5.0\text{ mA}$ )	$h_{FE}$	35	60	–	
DTC114EET1, SDTC114EET1		60	100	–	
DTC124EET1, SDTC124EET1		80	140	–	
DTC144EET1		80	140	–	
DTC114YET1, SDTC114YET1		160	350	–	
DTC114TET1		160	350	–	
DTC143TET1		8.0	15	–	
DTC123EET1		15	30	–	
DTC143EET1		80	200	–	
DTC143ZET1		80	150	–	
DTC124XET1		80	140	–	
DTC123JET1		80	150	–	
DTC115EET1		80	140	–	
DTC144WET1		80	140	–	
Collector–Emitter Saturation Voltage ( $I_C = 10\text{ mA}$ , $I_B = 0.3\text{ mA}$ ) ( $I_C = 10\text{ mA}$ , $I_B = 5\text{ mA}$ ) DTC123EET1 ( $I_C = 10\text{ mA}$ , $I_B = 1\text{ mA}$ ) DTC143TET1/DTC114TET1/ DTC143EET1/DTC143ZET1/DTC124XET1	$V_{CE(sat)}$	–	–	0.25	Vdc
Output Voltage (on) ( $V_{CC} = 5.0\text{ V}$ , $V_B = 2.5\text{ V}$ , $R_L = 1.0\text{ k}\Omega$ )	$V_{OL}$				Vdc
DTC114EET1, SDTC114EET1		–	–	0.2	
DTC124EET1, SDTC124EET1		–	–	0.2	
DTC114YET1, SDTC114YET1		–	–	0.2	
DTC114TET1		–	–	0.2	
DTC143TET1		–	–	0.2	
DTC123EET1		–	–	0.2	
DTC143EET1		–	–	0.2	
DTC143ZET1		–	–	0.2	
DTC124XET1		–	–	0.2	
DTC123JET1		–	–	0.2	
( $V_{CC} = 5.0\text{ V}$ , $V_B = 3.5\text{ V}$ , $R_L = 1.0\text{ k}\Omega$ )		–	–	0.2	
( $V_{CC} = 5.0\text{ V}$ , $V_B = 5.5\text{ V}$ , $R_L = 1.0\text{ k}\Omega$ )		–	–	0.2	
( $V_{CC} = 5.0\text{ V}$ , $V_B = 4.0\text{ V}$ , $R_L = 1.0\text{ k}\Omega$ )		–	–	0.2	
Output Voltage (off) ( $V_{CC} = 5.0\text{ V}$ , $V_B = 0.5\text{ V}$ , $R_L = 1.0\text{ k}\Omega$ ) ( $V_{CC} = 5.0\text{ V}$ , $V_B = 0.25\text{ V}$ , $R_L = 1.0\text{ k}\Omega$ )	$V_{OH}$	4.9	–	–	Vdc
DTC143TET1					
DTC143ZET1					
DTC114TET1					

3. Pulse Test: Pulse Width < 300  $\mu\text{s}$ , Duty Cycle < 2.0%

# DTC114EET1 Series, SDTC114EET1 Series

## ELECTRICAL CHARACTERISTICS ( $T_A = 25^\circ\text{C}$ unless otherwise noted) (Continued)

Characteristic		Symbol	Min	Typ	Max	Unit
Input Resistor	SDTC114EET1, SDTC114ET1	R1	7.0	10	13	k $\Omega$
	DTC124EET1, SDTC124EET1		15.4	22	28.6	
	DTC144EET1		32.9	47	61.1	
	DTC114YET1, SDTC114YET1		7.0	10	13	
	DTC114TET1		7.0	10	13	
	DTC143TET1		3.3	4.7	6.1	
	DTC123EET1		1.5	2.2	2.9	
	DTC143EET1		3.3	4.7	6.1	
	DTC143ZET1		3.3	4.7	6.1	
	DTC124XET1		15.4	22	28.6	
	DTC123JET1		1.54	2.2	2.86	
	DTC115EET1		70	100	130	
	DTC144WET1		32.9	47	61.1	
	Resistor Ratio		DTC114EET1/SDTC114EET1/DTC115EET1	R <sub>1</sub> /R <sub>2</sub>	0.8	
DTC124EET1/SDTC124EET1/DTC144EET1		0.17	0.21		0.25	
DTC114YET1/SDTC114YET1		–	–		–	
DTC143TET1/DTC114TET1		–	–		–	
DTC123EET1/DTC143EET1		0.8	1.0		1.2	
DTC143ZET1		0.055	0.1		0.185	
DTC124XET1		0.38	0.47		0.56	
DTC123JET1		0.038	0.047		0.056	
DTC144WET1D		1.7	2.1		2.6	

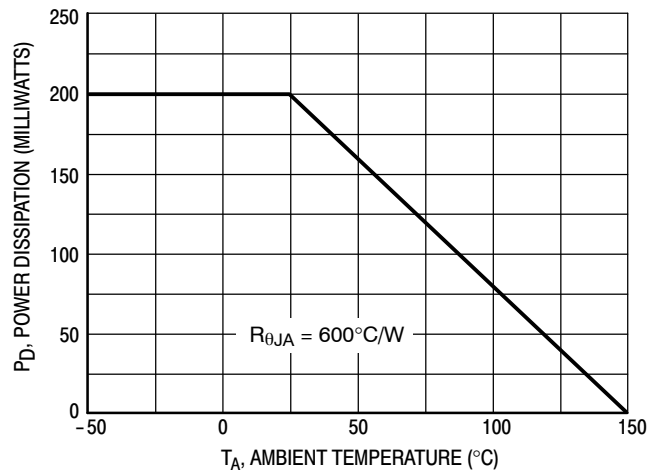

**Figure 1. Derating Curve**



**Figure 2. Normalized Thermal Response**

# DTC114EET1 Series, SDTC114EET1 Series

## TYPICAL ELECTRICAL CHARACTERISTICS – DTC114EET1, SDTC114EET1

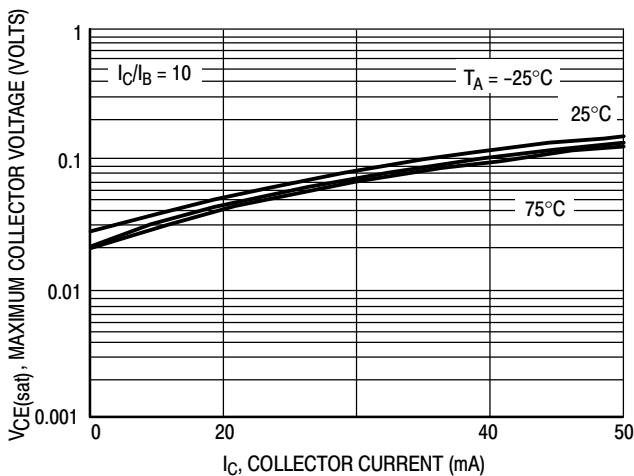

Figure 3.  $V_{CE(sat)}$  versus  $I_C$

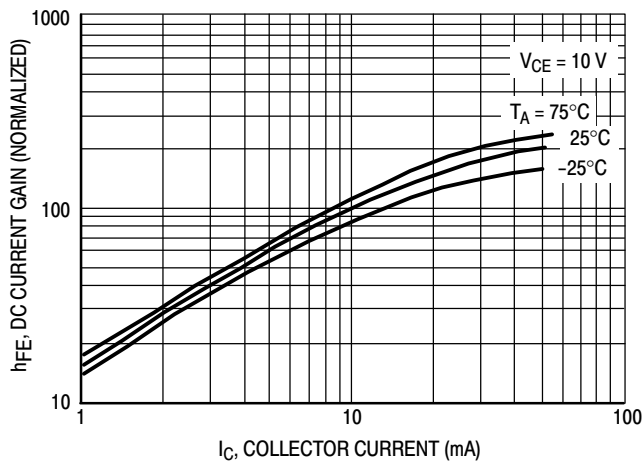

Figure 4. DC Current Gain

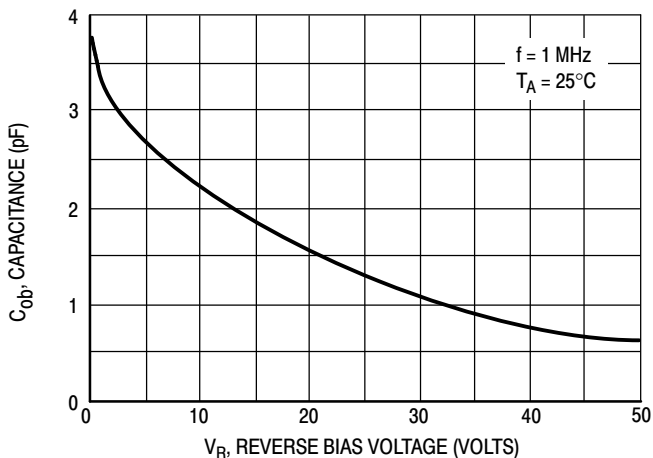

Figure 5. Output Capacitance

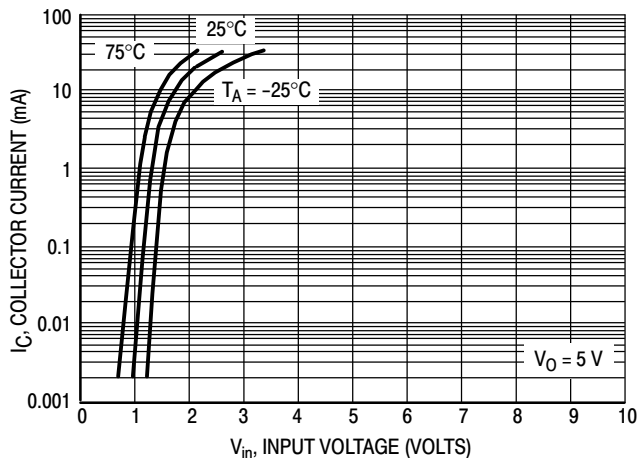

Figure 6. Output Current versus Input Voltage

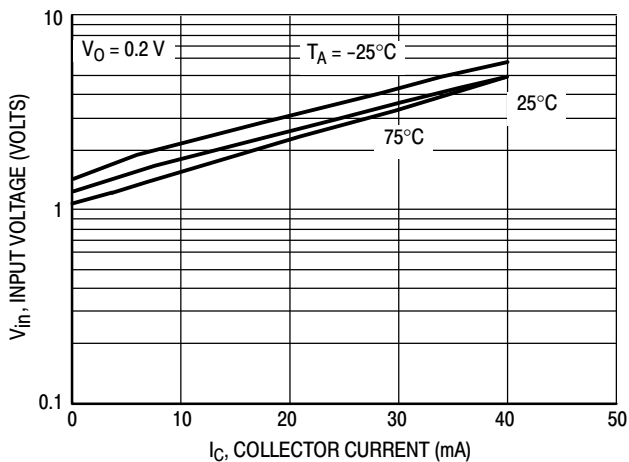

Figure 7. Input Voltage versus Output Current

# DTC114EET1 Series, SDTC114EET1 Series

## TYPICAL ELECTRICAL CHARACTERISTICS - DTC123EET1

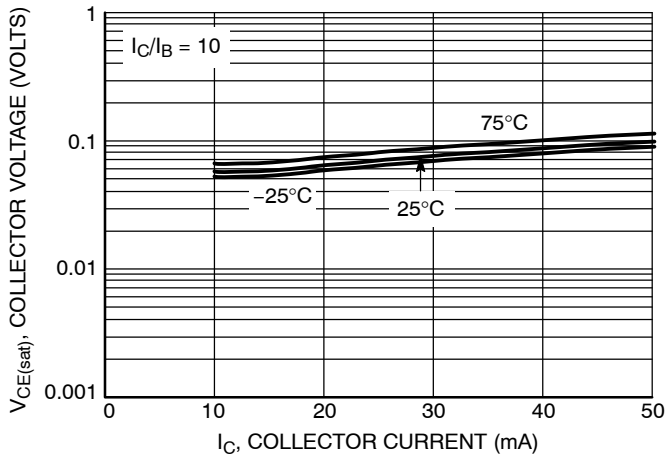

Figure 8.  $V_{CE(sat)}$  versus  $I_C$

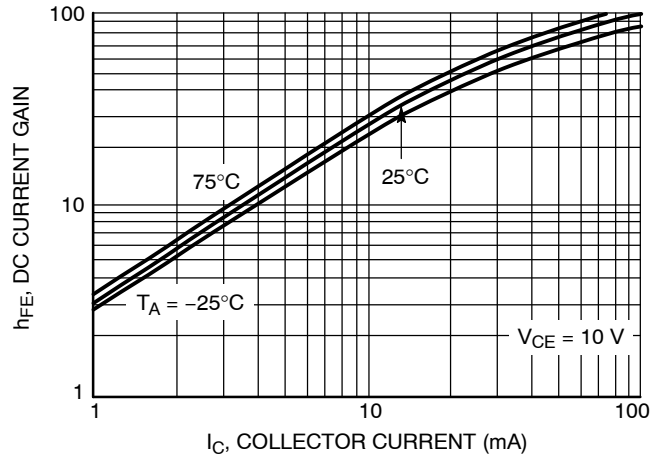

Figure 9. DC Current Gain

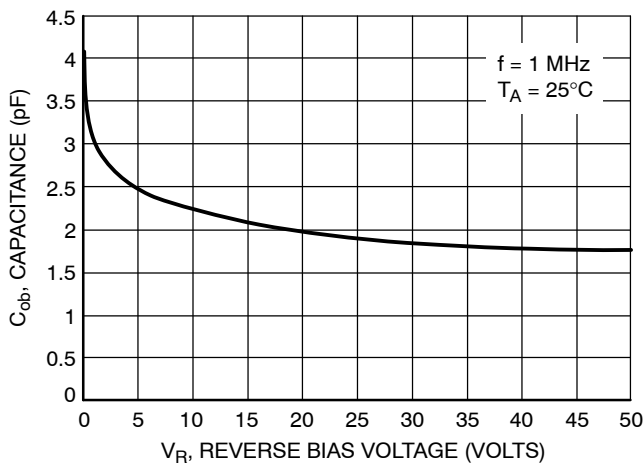

Figure 10. Output Capacitance

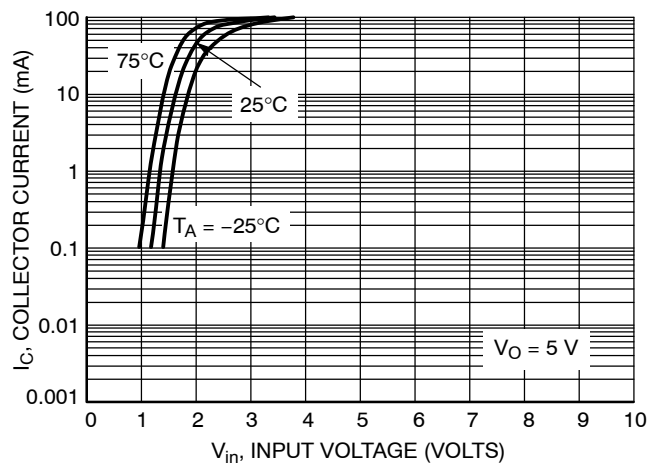

Figure 11. Output Current versus Input Voltage

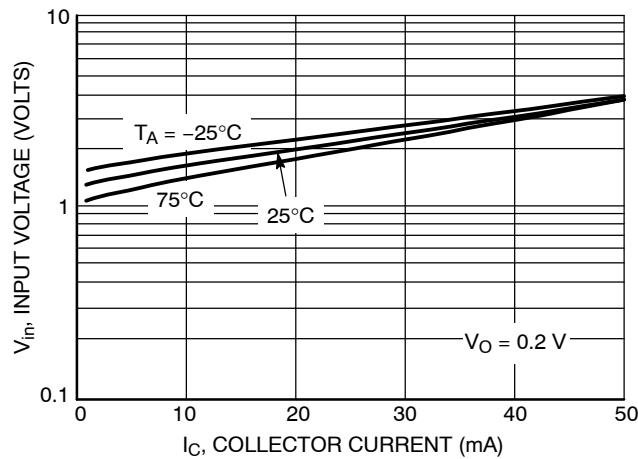

Figure 12. Input Voltage versus Output Current

# DTC114EET1 Series, SDTC114EET1 Series

## TYPICAL ELECTRICAL CHARACTERISTICS – DTC124EET1, SDTC124EET1

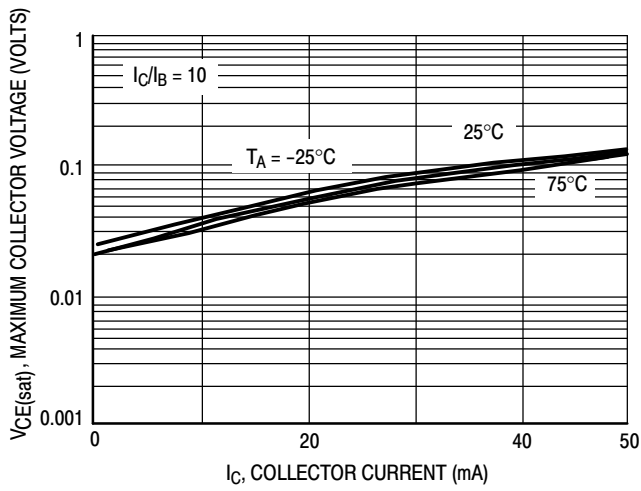

Figure 13.  $V_{CE(sat)}$  versus  $I_C$

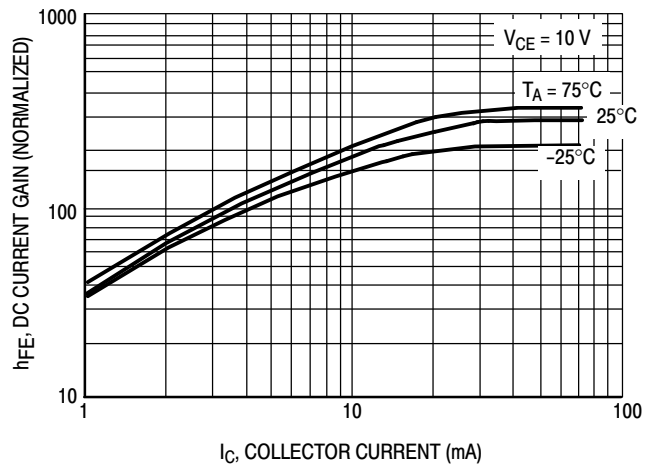

Figure 14. DC Current Gain

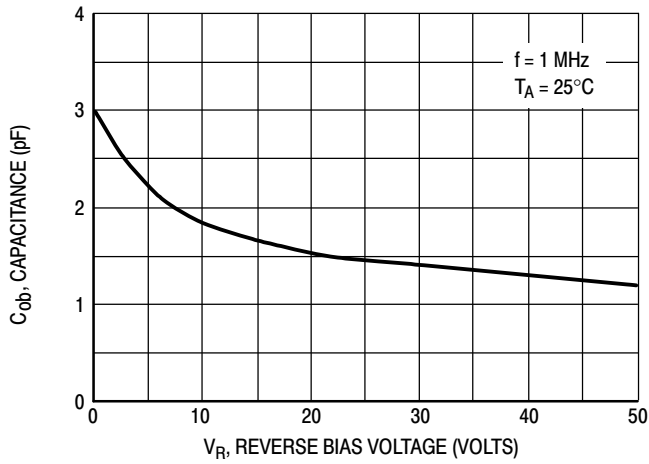

Figure 15. Output Capacitance

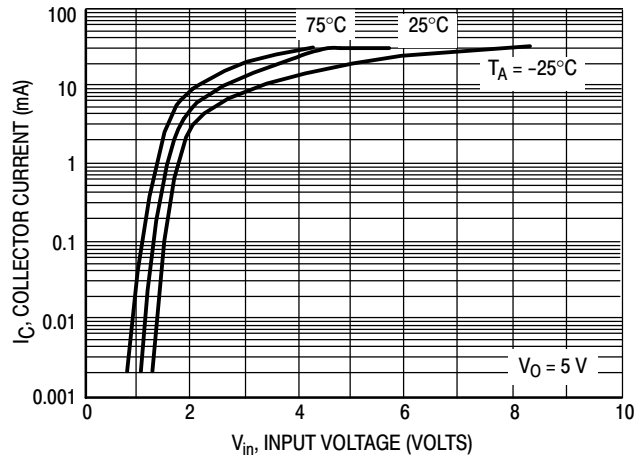

Figure 16. Output Current versus Input Voltage

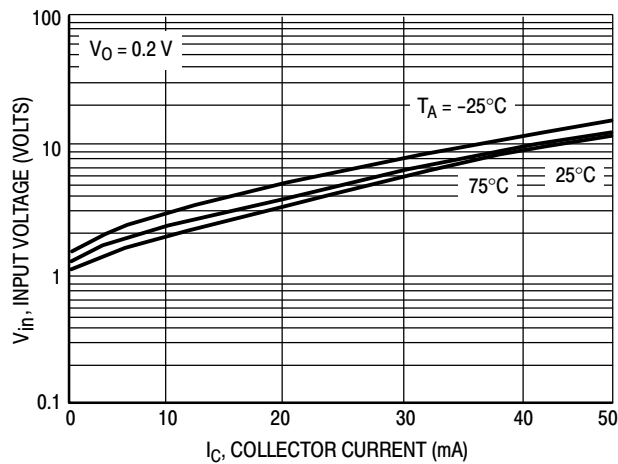

Figure 17. Input Voltage versus Output Current

# DTC114EET1 Series, SDTC114EET1 Series

## TYPICAL ELECTRICAL CHARACTERISTICS - DTC144EET1



Figure 18.  $V_{CE(sat)}$  versus  $I_C$



Figure 19. DC Current Gain



Figure 20. Output Capacitance



Figure 21. Output Current versus Input Voltage

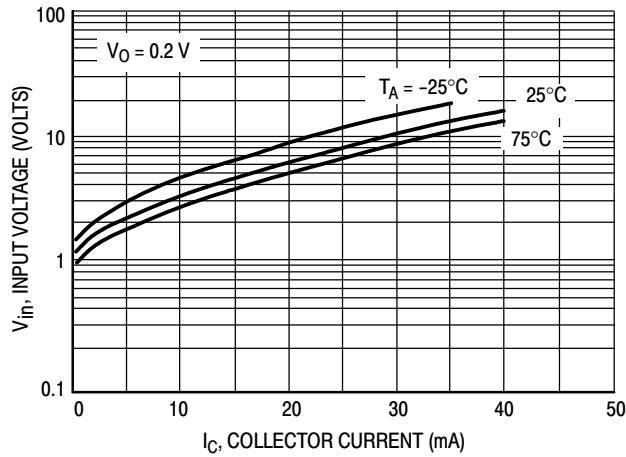

Figure 22. Input Voltage versus Output Current



# DTC114EET1 Series, SDTC114EET1 Series

## TYPICAL ELECTRICAL CHARACTERISTICS – DTC114YET1, SDTC114YET1

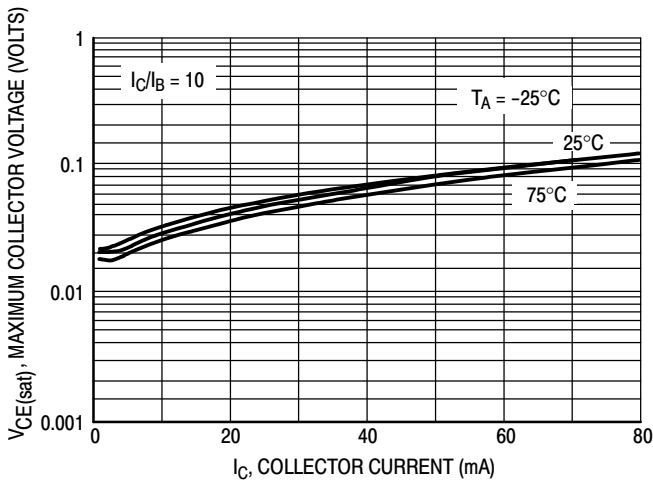

Figure 23.  $V_{CE(sat)}$  versus  $I_C$

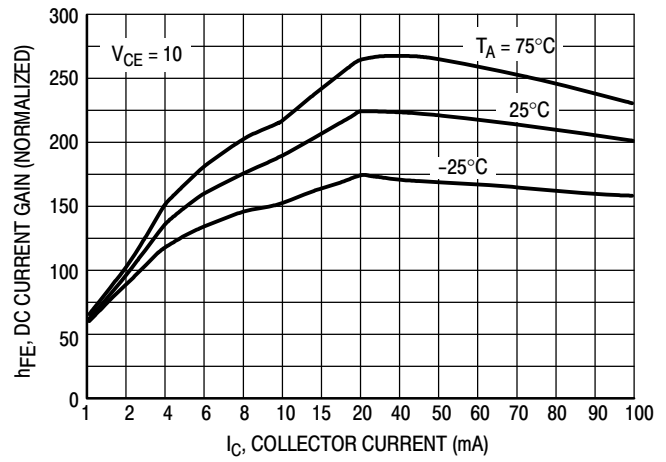

Figure 24. DC Current Gain

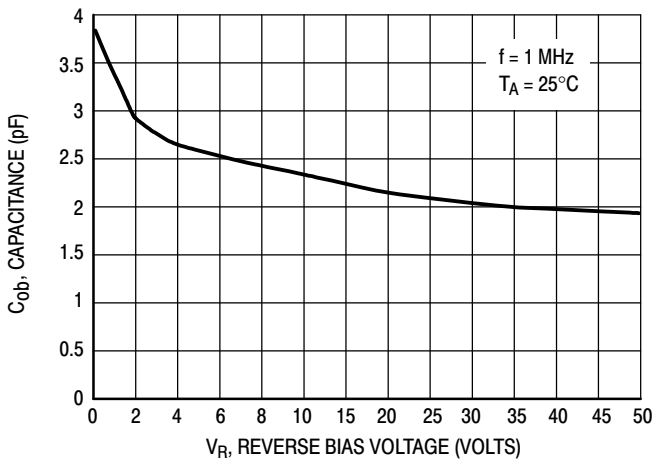

Figure 25. Output Capacitance

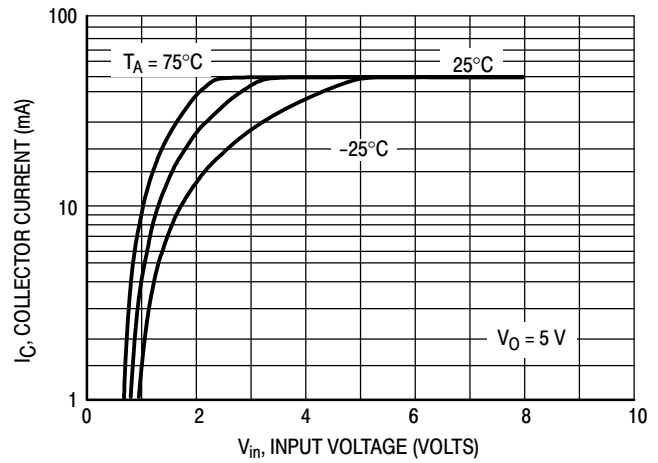

Figure 26. Output Current versus Input Voltage

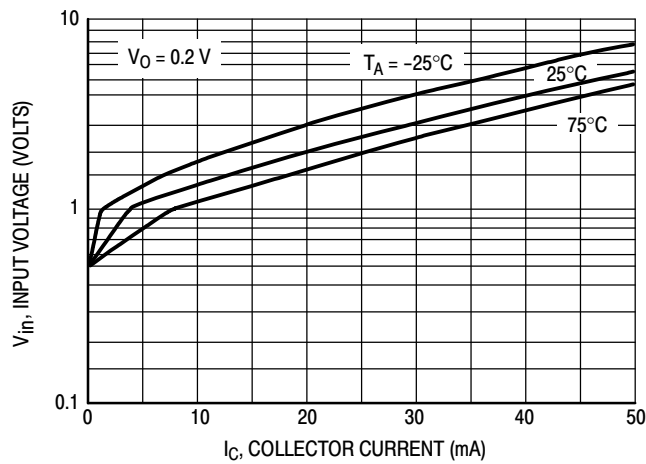

Figure 27. Input Voltage versus Output Current

# DTC114EET1 Series, SDTC114EET1 Series

## TYPICAL ELECTRICAL CHARACTERISTICS – DTC123JET1G

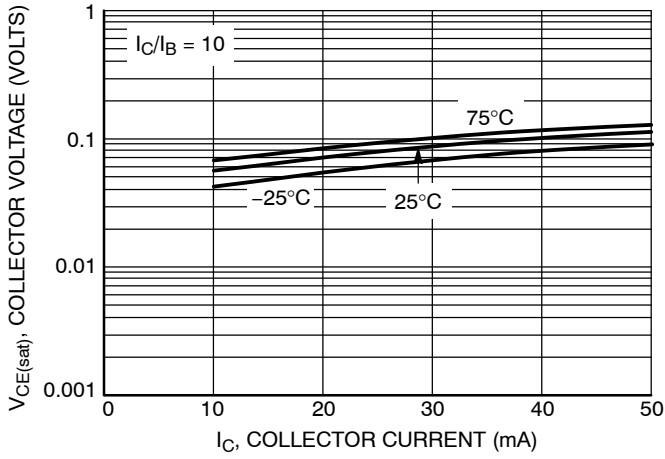

Figure 28.  $V_{CE(sat)}$  versus  $I_C$

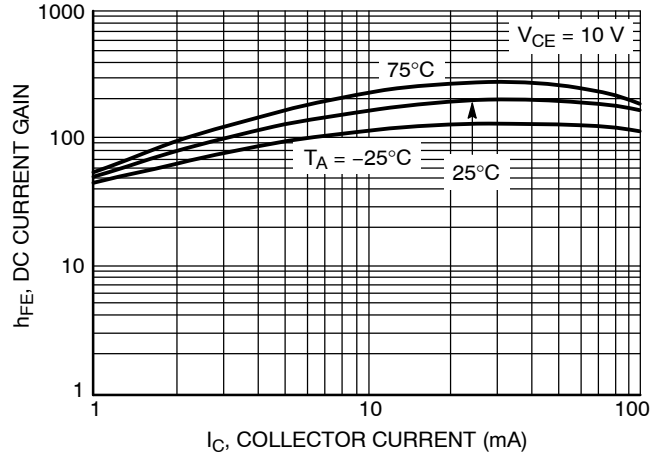

Figure 29. DC Current Gain

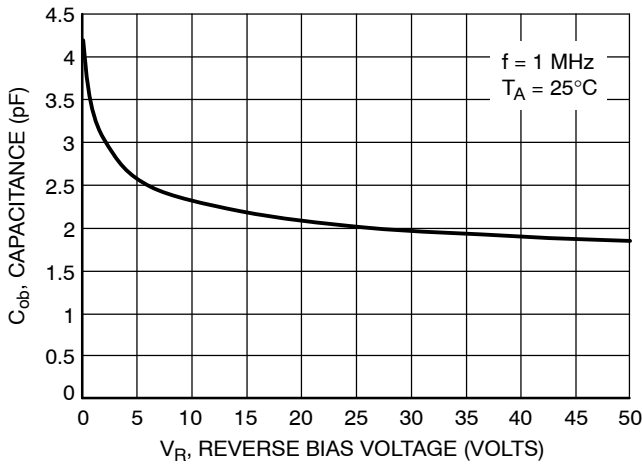

Figure 30. Output Capacitance

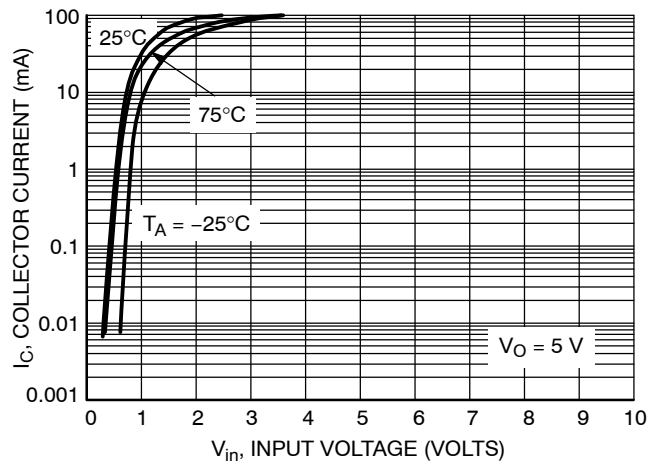

Figure 31. Output Current versus Input Voltage

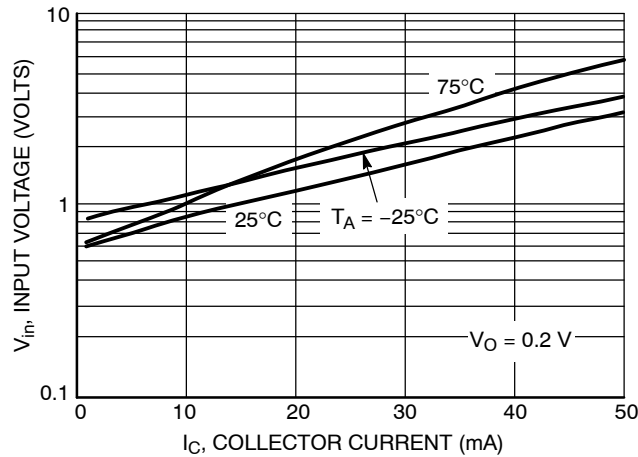

Figure 32. Input Voltage versus Output Current

# DTC114EET1 Series, SDTC114EET1 Series

## TYPICAL ELECTRICAL CHARACTERISTICS - DTC143ZET1

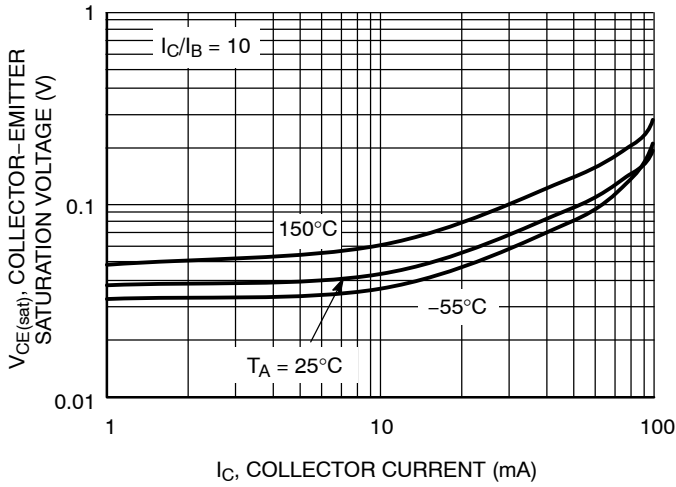

Figure 33.  $V_{CE(sat)}$  versus  $I_C$

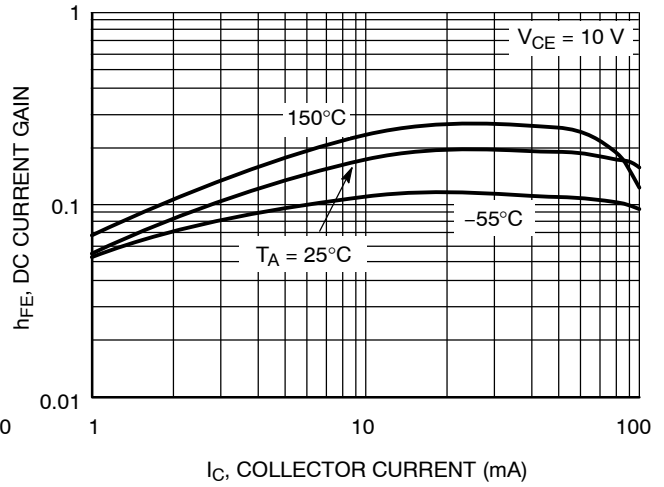

Figure 34. DC Current Gain

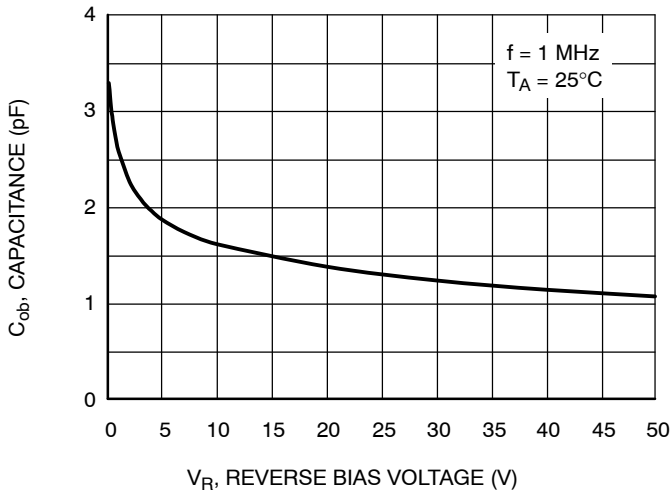

Figure 35. Output Capacitance

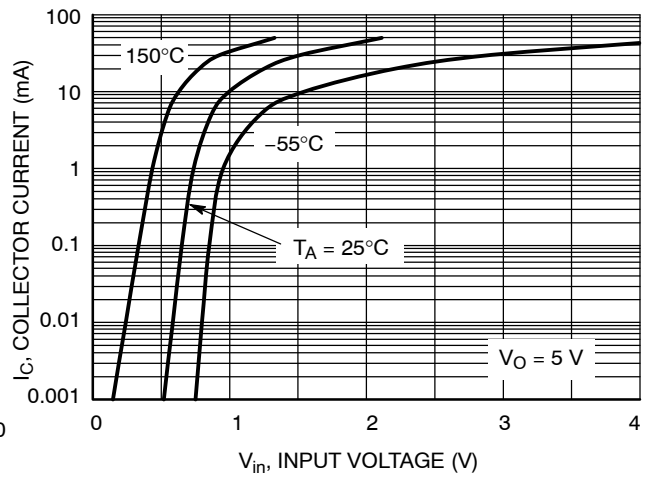

Figure 36. Output Current versus Input Voltage

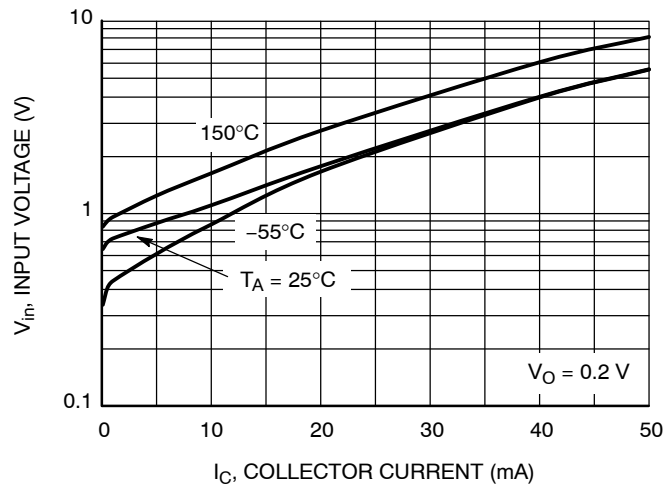

Figure 37. Input Voltage versus Output Current

# DTC114EET1 Series, SDTC114EET1 Series

## TYPICAL APPLICATIONS FOR NPN BRTs

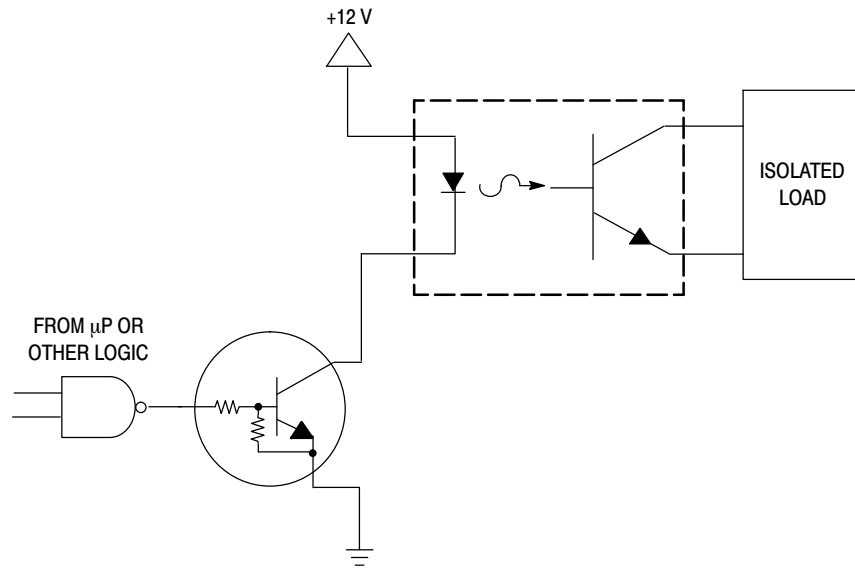

Figure 38. Level Shifter: Connects 12 or 24 Volt Circuits to Logic



Figure 39. Open Collector Inverter: Inverts the Input Signal

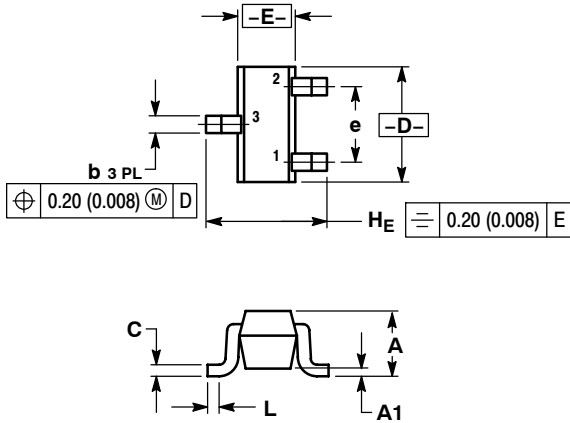

Figure 40. Inexpensive, Unregulated Current Source

# DTC114EET1 Series, SDTC114EET1 Series

## PACKAGE DIMENSIONS

SC-75/SOT-416  
CASE 463  
ISSUE F



NOTES:

1. DIMENSIONING AND TOLERANCING PER ANSI Y14.5M, 1982.
2. CONTROLLING DIMENSION: MILLIMETER.

DIM	MILLIMETERS			INCHES		
	MIN	NOM	MAX	MIN	NOM	MAX
A	0.70	0.80	0.90	0.027	0.031	0.035
A1	0.00	0.05	0.10	0.000	0.002	0.004
b	0.15	0.20	0.30	0.006	0.008	0.012
C	0.10	0.15	0.25	0.004	0.006	0.010
D	1.55	1.60	1.65	0.059	0.063	0.067
E	0.70	0.80	0.90	0.027	0.031	0.035
e	1.00 BSC			0.04 BSC		
L	0.10	0.15	0.20	0.004	0.006	0.008
HE	1.50	1.60	1.70	0.061	0.063	0.065

STYLE 1:

1. BASE
2. EMITTER
3. COLLECTOR

### SOLDERING FOOTPRINT\*

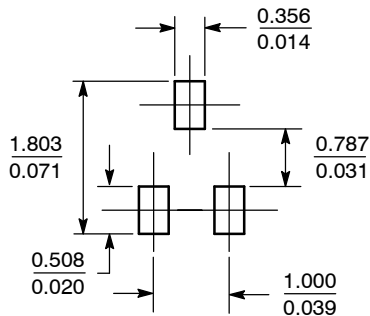

SCALE 10:1 (mm/inches)

\*For additional information on our Pb-Free strategy and soldering details, please download the ON Semiconductor Soldering and Mounting Techniques Reference Manual, SOLDERRM/D.

ON Semiconductor and are registered trademarks of Semiconductor Components Industries, LLC (SCILLC). SCILLC reserves the right to make changes without further notice to any products herein. SCILLC makes no warranty, representation or guarantee regarding the suitability of its products for any particular purpose, nor does SCILLC assume any liability arising out of the application or use of any product or circuit, and specifically disclaims any and all liability, including without limitation special, consequential or incidental damages. "Typical" parameters which may be provided in SCILLC data sheets and/or specifications can and do vary in different applications and actual performance may vary over time. All operating parameters, including "Typicals" must be validated for each customer application by customer's technical experts. SCILLC does not convey any license under its patent rights nor the rights of others. SCILLC products are not designed, intended, or authorized for use as components in systems intended for surgical implant into the body, or other applications intended to support or sustain life, or for any other application in which the failure of the SCILLC product could create a situation where personal injury or death may occur. Should Buyer purchase or use SCILLC products for any such unintended or unauthorized application, Buyer shall indemnify and hold SCILLC and its officers, employees, subsidiaries, affiliates, and distributors harmless against all claims, costs, damages, and expenses, and reasonable attorney fees arising out of, directly or indirectly, any claim of personal injury or death associated with such unintended or unauthorized use, even if such claim alleges that SCILLC was negligent regarding the design or manufacture of the part. SCILLC is an Equal Opportunity/Affirmative Action Employer. This literature is subject to all applicable copyright laws and is not for resale in any manner.

### PUBLICATION ORDERING INFORMATION

**LITERATURE FULFILLMENT:**  
Literature Distribution Center for ON Semiconductor  
P.O. Box 5163, Denver, Colorado 80217 USA  
**Phone:** 303-675-2175 or 800-344-3860 Toll Free USA/Canada  
**Fax:** 303-675-2176 or 800-344-3867 Toll Free USA/Canada  
**Email:** orderlit@onsemi.com

**N. American Technical Support:** 800-282-9855 Toll Free  
USA/Canada  
**Europe, Middle East and Africa Technical Support:**  
Phone: 421 33 790 2910  
**Japan Customer Focus Center**  
Phone: 81-3-5817-1050

**ON Semiconductor Website:** [www.onsemi.com](http://www.onsemi.com)  
**Order Literature:** <http://www.onsemi.com/orderlit>

For additional information, please contact your local Sales Representative

Компания «Океан Электроники» предлагает заключение долгосрочных отношений при поставках импортных электронных компонентов на взаимовыгодных условиях!

Наши преимущества:

- Поставка оригинальных импортных электронных компонентов напрямую с производств Америки, Европы и Азии, а так же с крупнейших складов мира;
- Широкая линейка поставок активных и пассивных импортных электронных компонентов (более 30 млн. наименований);
- Поставка сложных, дефицитных, либо снятых с производства позиций;
- Оперативные сроки поставки под заказ (от 5 рабочих дней);
- Экспресс доставка в любую точку России;
- Помощь Конструкторского Отдела и консультации квалифицированных инженеров;
- Техническая поддержка проекта, помощь в подборе аналогов, поставка прототипов;
- Поставка электронных компонентов под контролем ВП;
- Система менеджмента качества сертифицирована по Международному стандарту ISO 9001;
- При необходимости вся продукция военного и аэрокосмического назначения проходит испытания и сертификацию в лаборатории (по согласованию с заказчиком);
- Поставка специализированных компонентов военного и аэрокосмического уровня качества (Xilinx, Altera, Analog Devices, Intersil, Interpoint, Microsemi, Actel, Aeroflex, Peregrine, VPT, Syfer, Eurofarad, Texas Instruments, MS Kennedy, Miteq, Cobham, E2V, MA-COM, Hittite, Mini-Circuits, General Dynamics и др.);

Компания «Океан Электроники» является официальным дистрибьютором и эксклюзивным представителем в России одного из крупнейших производителей разъемов военного и аэрокосмического назначения «JONHON», а так же официальным дистрибьютором и эксклюзивным представителем в России производителя высокотехнологичных и надежных решений для передачи СВЧ сигналов «FORSTAR».



## JONHON

«JONHON» (основан в 1970 г.)

Разъемы специального, военного и аэрокосмического назначения:

(Применяются в военной, авиационной, аэрокосмической, морской, железнодорожной, горно- и нефтедобывающей отраслях промышленности)

«FORSTAR» (основан в 1998 г.)

ВЧ соединители, коаксиальные кабели,  
кабельные сборки и микроволновые компоненты:

(Применяются в телекоммуникациях гражданского и специального назначения, в средствах связи, РЛС, а так же военной, авиационной и аэрокосмической отраслях промышленности).



Телефон: 8 (812) 309-75-97 (многоканальный)

Факс: 8 (812) 320-03-32

Электронная почта: [ocean@oceanchips.ru](mailto:ocean@oceanchips.ru)

Web: <http://oceanchips.ru/>

Адрес: 198099, г. Санкт-Петербург, ул. Калинина, д. 2, корп. 4, лит. А