

DTC114EET1 Series, SDTC114EET1 Series



ON Semiconductor®

<http://onsemi.com>

Bias Resistor Transistor NPN Silicon Surface Mount Transistor with Monolithic Bias Resistor Network

This new series of digital transistors is designed to replace a single device and its external resistor bias network. The BRT (Bias Resistor Transistor) contains a single transistor with a monolithic bias network consisting of two resistors; a series base resistor and a base-emitter resistor. The BRT eliminates these individual components by integrating them into a single device. The use of a BRT can reduce both system cost and board space. The device is housed in the SC-75/SOT-416 package which is designed for low power surface mount applications.

Features

- Simplifies Circuit Design
- Reduces Board Space
- Reduces Component Count
- The SC-75/SOT-416 Package Can be Soldered Using Wave or Reflow
- The Modified Gull-Winged Leads Absorb Thermal Stress During Soldering Eliminating the Possibility of Damage to the Die
- Pb-Free Packages are Available
- S Prefix for Automotive and Other Applications Requiring Unique Site and Control Change Requirements; AEC-Q101 Qualified and PPAP Capable

MAXIMUM RATINGS ($T_A = 25^\circ\text{C}$ unless otherwise noted)

Rating	Symbol	Value	Unit
Collector-Base Voltage	V_{CBO}	50	Vdc
Collector-Emitter Voltage	V_{CEO}	50	Vdc
Collector Current	I_C	100	mAdc

THERMAL CHARACTERISTICS

Rating	Symbol	Value	Unit
Total Device Dissipation, FR-4 Board (Note 1) @ $T_A = 25^\circ\text{C}$ Derate above 25°C	P_D	200 1.6	mW mW/ $^\circ\text{C}$
Thermal Resistance, Junction-to-Ambient (Note 1)	$R_{\theta JA}$	600	$^\circ\text{C}/\text{W}$
Total Device Dissipation, FR-4 Board (Note 2) @ $T_A = 25^\circ\text{C}$ Derate above 25°C	P_D	300 2.4	mW mW/ $^\circ\text{C}$
Thermal Resistance, Junction-to-Ambient (Note 2)	$R_{\theta JA}$	400	$^\circ\text{C}/\text{W}$
Junction and Storage Temperature Range	T_J, T_{stg}	-55 to +150	$^\circ\text{C}$

Stresses exceeding Maximum Ratings may damage the device. Maximum Ratings are stress ratings only. Functional operation above the Recommended Operating Conditions is not implied. Extended exposure to stresses above the Recommended Operating Conditions may affect device reliability.

1. FR-4 @ Minimum Pad
2. FR-4 @ 1.0 x 1.0 Inch Pad

NPN SILICON BIAS RESISTOR TRANSISTORS

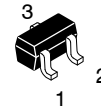
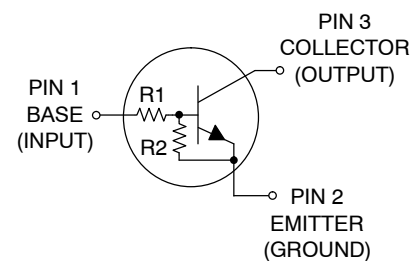

SC-75 (SOT-416)
CASE 463
STYLE 1

MARKING DIAGRAM

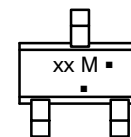

xx = Specific Device Code
xx = (Refer to page 2)

M = Date Code*

▪ = Pb-Free Package

(Note: Microdot may be in either location)

*Date Code orientation may vary depending upon manufacturing location.

ORDERING INFORMATION

See detailed ordering, marking, and shipping information in the package dimensions section on page 2 of this data sheet.

DTC114EET1 Series, SDTC114EET1 Series

ORDERING INFORMATION, DEVICE MARKING and RESISTOR VALUES

Device	Marking	R1 (K)	R2 (K)	Package	Shipping†
DTC114EET1	8A	10	10	SC-75/SOT-416	3000 Tape & Reel
DTC114EET1G				SC-75/SOT-416 (Pb-Free)	3000 Tape & Reel
SDTC114EET1G					
DTC124EET1	8B	22	22	SC-75/SOT-416	3000 Tape & Reel
DTC124EET1G				SC-75/SOT-416 (Pb-Free)	3000 Tape & Reel
SDTC124EET1G					
DTC144EET1	8C	47	47	SC-75/SOT-416	3000 Tape & Reel
DTC144EET1G				SC-75/SOT-416 (Pb-Free)	3000 Tape & Reel
DTC114YET1	8D	10	47	SC-75/SOT-416	3000 Tape & Reel
DTC114YET1G				SC-75/SOT-416 (Pb-Free)	3000 Tape & Reel
SDTC114YET1G					
DTC114TET1	94	10	∞	SC-75/SOT-416	3000 Tape & Reel
DTC114TET1G				SC-75/SOT-416 (Pb-Free)	3000 Tape & Reel
DTC143TET1	8F	4.7	∞	SC-75/SOT-416	3000 Tape & Reel
DTC143TET1G				SC-75/SOT-416 (Pb-Free)	3000 Tape & Reel
DTC123EET1	8H	2.2	2.2	SC-75/SOT-416	3000 Tape & Reel
DTC123EET1G				SC-75/SOT-416 (Pb-Free)	3000 Tape & Reel
DTC143EET1	8J	4.7	4.7	SC-75/SOT-416	3000 Tape & Reel
DTC143EET1G				SC-75/SOT-416 (Pb-Free)	3000 Tape & Reel
DTC143ZET1	8K	4.7	47	SC-75/SOT-416	3000 Tape & Reel
DTC143ZET1G				SC-75/SOT-416 (Pb-Free)	3000 Tape & Reel
DTC124XET1	8L	22	47	SC-75/SOT-416	3000 Tape & Reel
DTC124XET1G				SC-75/SOT-416 (Pb-Free)	3000 Tape & Reel
DTC123JET1	8M	2.2	47	SC-75/SOT-416	3000 Tape & Reel
DTC123JET1G				SC-75/SOT-416 (Pb-Free)	3000 Tape & Reel
DTC115EET1	8N	100	100	SC-75/SOT-416	3000 Tape & Reel
DTC115EET1G				SC-75/SOT-416 (Pb-Free)	3000 Tape & Reel
DTC144WET1	8P	47	22	SC-75/SOT-416	3000 Tape & Reel
DTC144WET1G				SC-75/SOT-416	3000 Tape & Reel

†For information on tape and reel specifications, including part orientation and tape sizes, please refer to our Tape and Reel Packaging Specifications Brochure, BRD8011/D.

DTC114EET1 Series, SDTC114EET1 Series

ELECTRICAL CHARACTERISTICS ($T_A = 25^\circ\text{C}$ unless otherwise noted)

Characteristic	Symbol	Min	Typ	Max	Unit
OFF CHARACTERISTICS					
Collector–Base Cutoff Current ($V_{CB} = 50\text{ V}$, $I_E = 0$)	I_{CBO}	–	–	100	nAdc
Collector–Emitter Cutoff Current ($V_{CE} = 50\text{ V}$, $I_B = 0$)	I_{CEO}	–	–	500	nAdc
Emitter–Base Cutoff Current ($V_{EB} = 6.0\text{ V}$, $I_C = 0$)	I_{EBO}	–	–	0.5	mAdc
DTC114EET1, SDTC114EET1		–	–	0.2	
DTC124EET1, SDTC124EET1		–	–	0.1	
DTC144EET1		–	–	0.2	
DTC114YET1, SDTC114YET1		–	–	0.9	
DTC114TET1		–	–	1.9	
DTC143TET1		–	–	2.3	
DTC123EET1		–	–	1.5	
DTC143EET1		–	–	0.18	
DTC143ZET1		–	–	0.13	
DTC124XET1		–	–	0.2	
DTC123JET1		–	–	0.05	
DTC115EET1		–	–	0.13	
DTC144WET1		–	–		
Collector–Base Breakdown Voltage ($I_C = 10\ \mu\text{A}$, $I_E = 0$)	$V_{(BR)CBO}$	50	–	–	Vdc
Collector–Emitter Breakdown Voltage (Note 3) ($I_C = 2.0\text{ mA}$, $I_B = 0$)	$V_{(BR)CEO}$	50	–	–	Vdc
ON CHARACTERISTICS (Note 3)					
DC Current Gain ($V_{CE} = 10\text{ V}$, $I_C = 5.0\text{ mA}$)	h_{FE}	35	60	–	
DTC114EET1, SDTC114EET1		60	100	–	
DTC124EET1, SDTC124EET1		80	140	–	
DTC144EET1		80	140	–	
DTC114YET1, SDTC114YET1		80	140	–	
DTC114TET1		160	350	–	
DTC143TET1		160	350	–	
DTC123EET1		8.0	15	–	
DTC143EET1		15	30	–	
DTC143ZET1		80	200	–	
DTC124XET1		80	150	–	
DTC123JET1		80	140	–	
DTC115EET1		80	150	–	
DTC144WET1		80	140	–	
Collector–Emitter Saturation Voltage ($I_C = 10\text{ mA}$, $I_B = 0.3\text{ mA}$) ($I_C = 10\text{ mA}$, $I_B = 5\text{ mA}$) DTC123EET1 ($I_C = 10\text{ mA}$, $I_B = 1\text{ mA}$) DTC143TET1/DTC114TET1/ DTC143EET1/DTC143ZET1/DTC124XET1	$V_{CE(sat)}$	–	–	0.25	Vdc
Output Voltage (on) ($V_{CC} = 5.0\text{ V}$, $V_B = 2.5\text{ V}$, $R_L = 1.0\text{ k}\Omega$)	V_{OL}				Vdc
DTC114EET1, SDTC114EET1		–	–	0.2	
DTC124EET1, SDTC124EET1		–	–	0.2	
DTC114YET1, SDTC114YET1		–	–	0.2	
DTC114TET1		–	–	0.2	
DTC143TET1		–	–	0.2	
DTC123EET1		–	–	0.2	
DTC143EET1		–	–	0.2	
DTC143ZET1		–	–	0.2	
DTC124XET1		–	–	0.2	
DTC123JET1		–	–	0.2	
($V_{CC} = 5.0\text{ V}$, $V_B = 3.5\text{ V}$, $R_L = 1.0\text{ k}\Omega$)		–	–	0.2	
($V_{CC} = 5.0\text{ V}$, $V_B = 5.5\text{ V}$, $R_L = 1.0\text{ k}\Omega$)		–	–	0.2	
($V_{CC} = 5.0\text{ V}$, $V_B = 4.0\text{ V}$, $R_L = 1.0\text{ k}\Omega$)		–	–	0.2	
Output Voltage (off) ($V_{CC} = 5.0\text{ V}$, $V_B = 0.5\text{ V}$, $R_L = 1.0\text{ k}\Omega$) ($V_{CC} = 5.0\text{ V}$, $V_B = 0.25\text{ V}$, $R_L = 1.0\text{ k}\Omega$)	V_{OH}	4.9	–	–	Vdc
DTC143TET1					
DTC143ZET1					
DTC114TET1					

3. Pulse Test: Pulse Width < 300 μs , Duty Cycle < 2.0%

DTC114EET1 Series, SDTC114EET1 Series

ELECTRICAL CHARACTERISTICS ($T_A = 25^\circ\text{C}$ unless otherwise noted) (Continued)

Characteristic		Symbol	Min	Typ	Max	Unit
Input Resistor	SDTC114EET1, SDTC114ET1	R1	7.0	10	13	k Ω
	DTC124EET1, SDTC124EET1		15.4	22	28.6	
	DTC144EET1		32.9	47	61.1	
	DTC114YET1, SDTC114YET1		7.0	10	13	
	DTC114TET1		7.0	10	13	
	DTC143TET1		3.3	4.7	6.1	
	DTC123EET1		1.5	2.2	2.9	
	DTC143EET1		3.3	4.7	6.1	
	DTC143ZET1		3.3	4.7	6.1	
	DTC124XET1		15.4	22	28.6	
	DTC123JET1		1.54	2.2	2.86	
	DTC115EET1		70	100	130	
	DTC144WET1		32.9	47	61.1	
	Resistor Ratio		DTC114EET1/SDTC114EET1/DTC115EET1	R ₁ /R ₂	0.8	
DTC124EET1/SDTC124EET1/DTC144EET1		0.17	0.21		0.25	
DTC114YET1/SDTC114YET1		–	–		–	
DTC143TET1/DTC114TET1		0.8	1.0		1.2	
DTC123EET1/DTC143EET1		0.055	0.1		0.185	
DTC143ZET1		0.38	0.47		0.56	
DTC124XET1		0.038	0.047		0.056	
DTC123JET1		1.7	2.1		2.6	
DTC144WET1D						

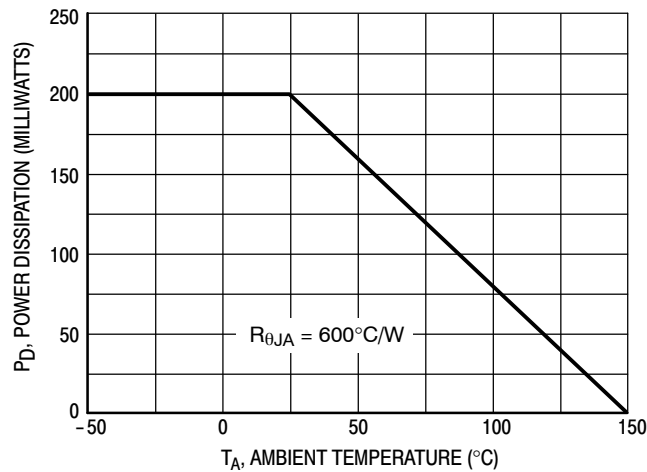

Figure 1. Derating Curve



Figure 2. Normalized Thermal Response

DTC114EET1 Series, SDTC114EET1 Series

TYPICAL ELECTRICAL CHARACTERISTICS – DTC114EET1, SDTC114EET1

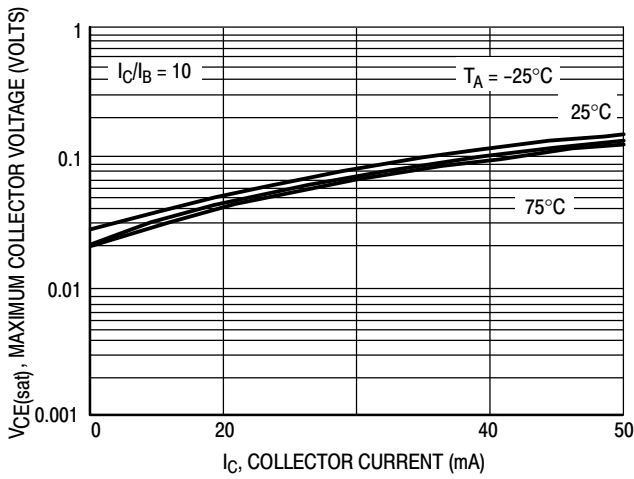

Figure 3. $V_{CE(sat)}$ versus I_C

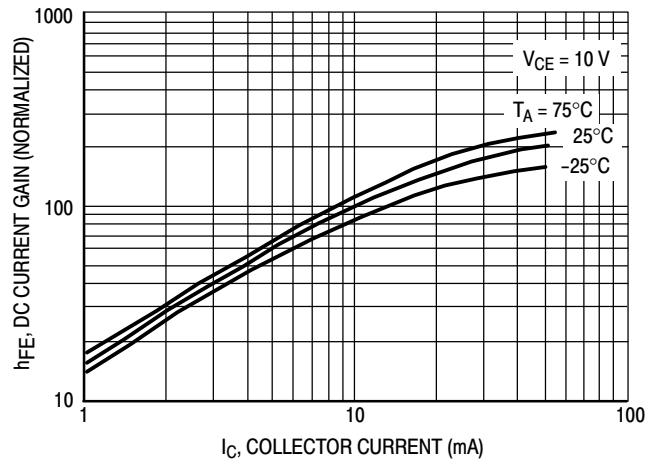

Figure 4. DC Current Gain

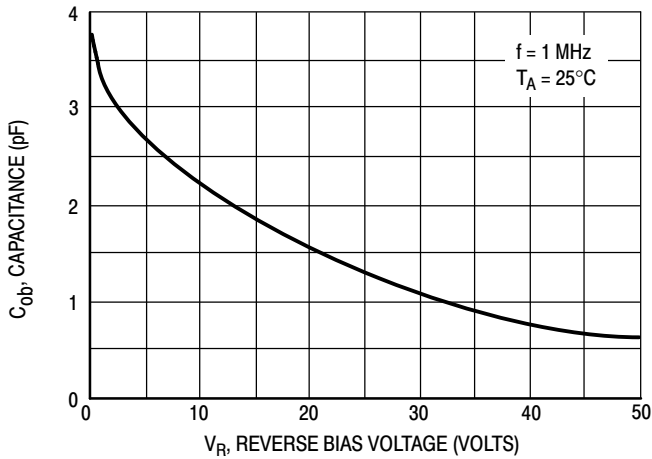

Figure 5. Output Capacitance

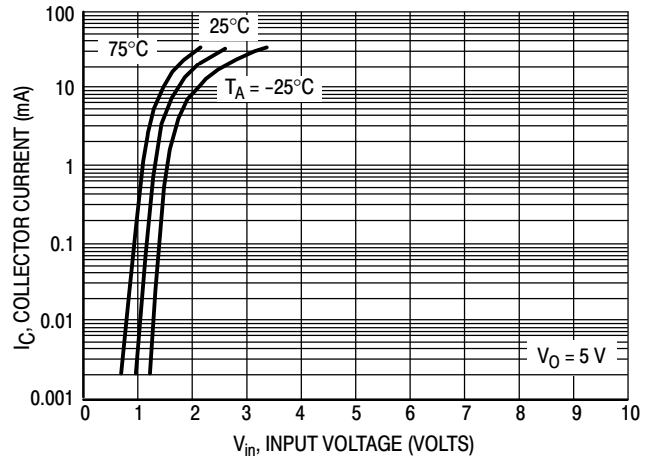

Figure 6. Output Current versus Input Voltage

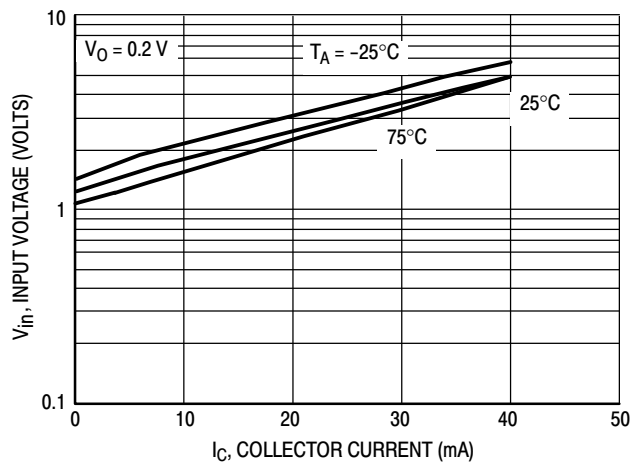

Figure 7. Input Voltage versus Output Current

TYPICAL ELECTRICAL CHARACTERISTICS - DTC123EET1

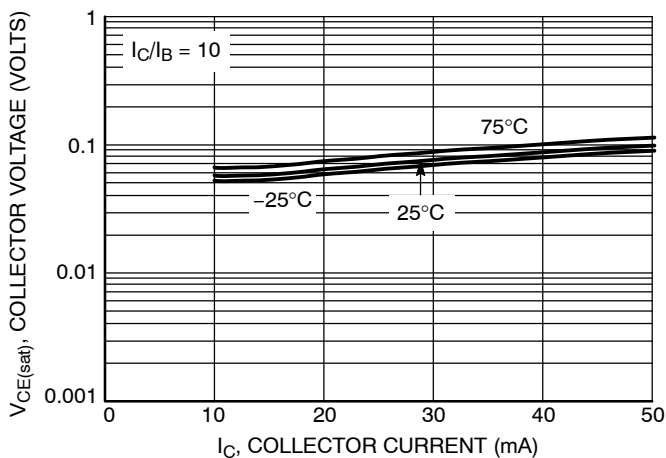

Figure 8. $V_{CE(sat)}$ versus I_C

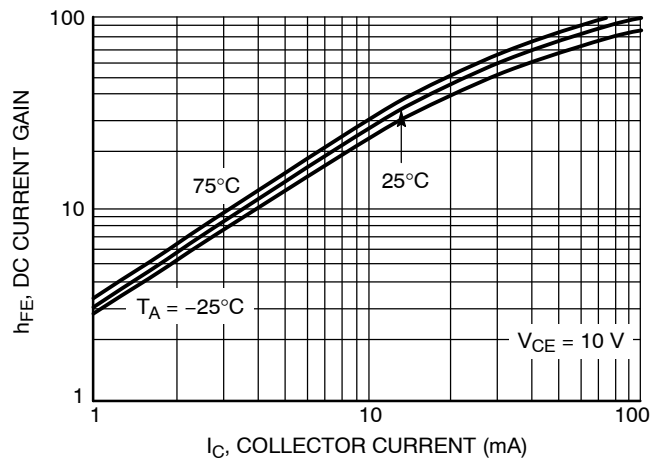

Figure 9. DC Current Gain

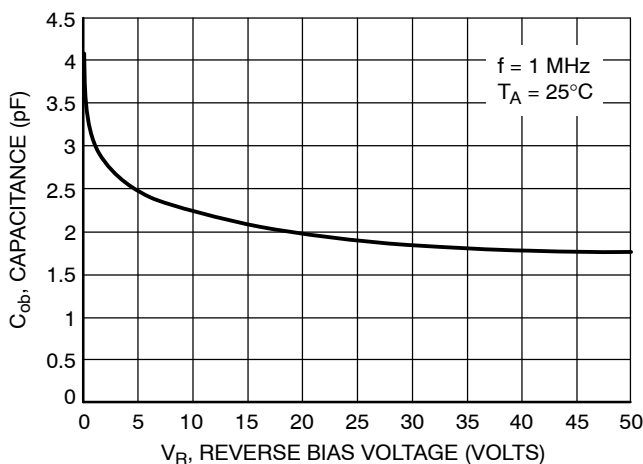

Figure 10. Output Capacitance

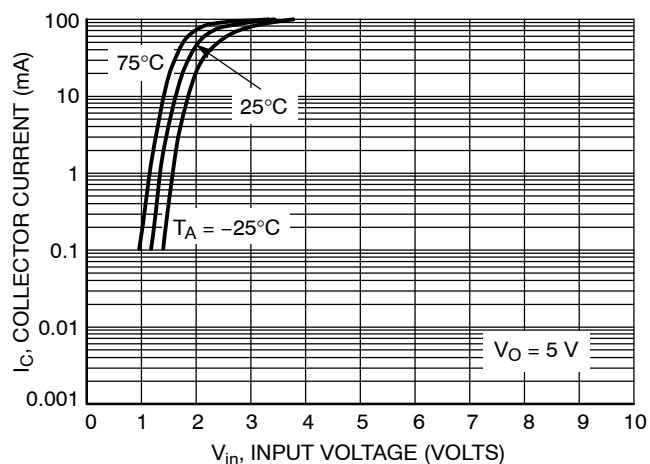

Figure 11. Output Current versus Input Voltage

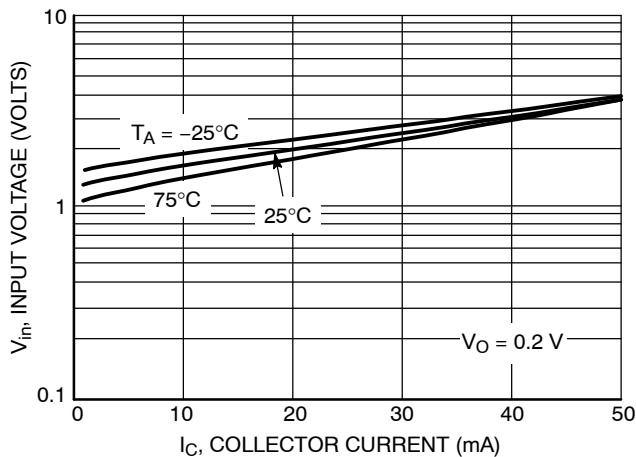

Figure 12. Input Voltage versus Output Current

DTC114EET1 Series, SDTC114EET1 Series

TYPICAL ELECTRICAL CHARACTERISTICS – DTC124EET1, SDTC124EET1

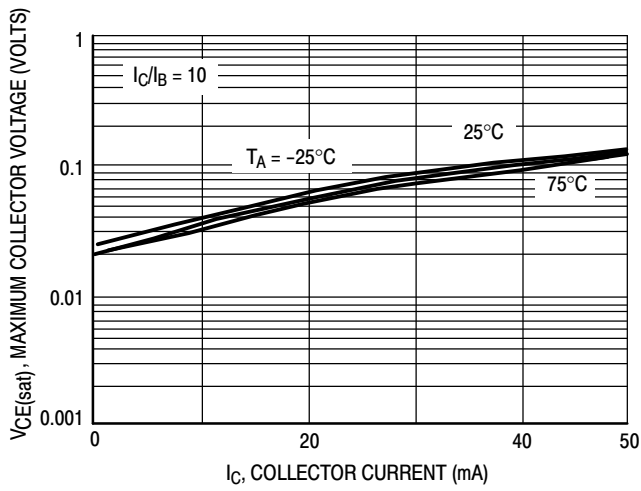

Figure 13. $V_{CE(sat)}$ versus I_C

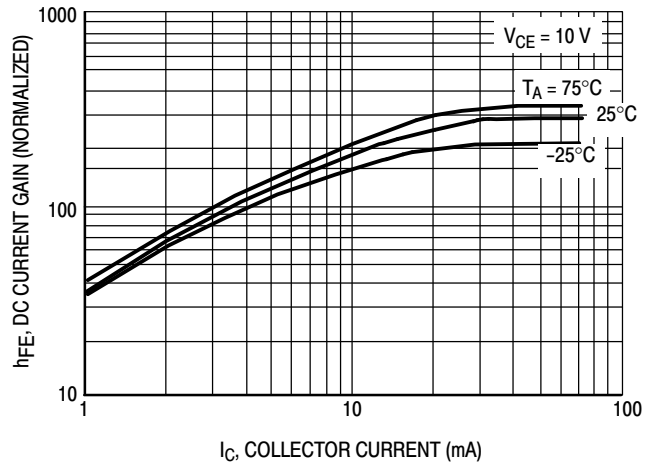

Figure 14. DC Current Gain

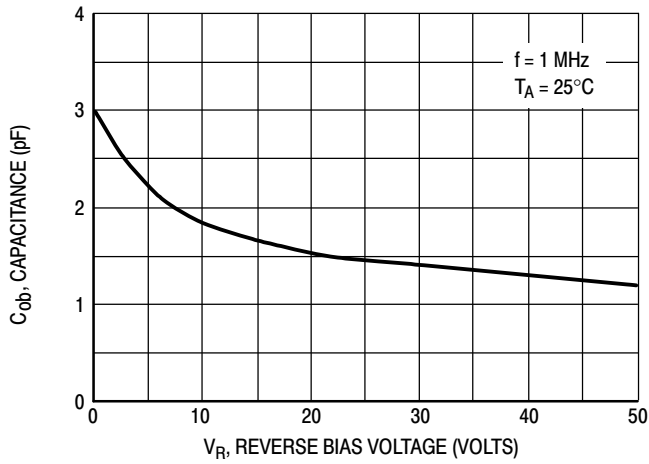

Figure 15. Output Capacitance

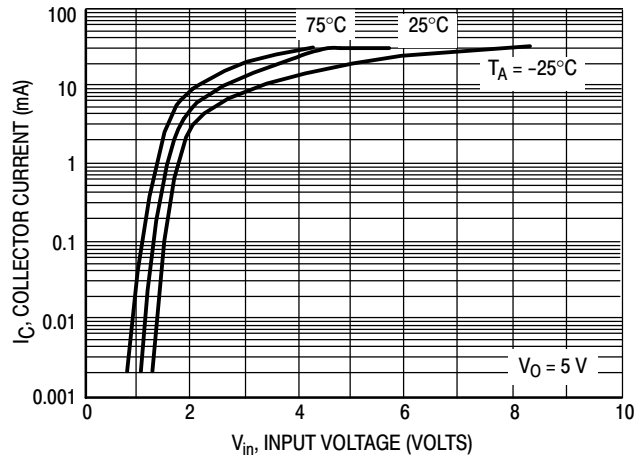

Figure 16. Output Current versus Input Voltage

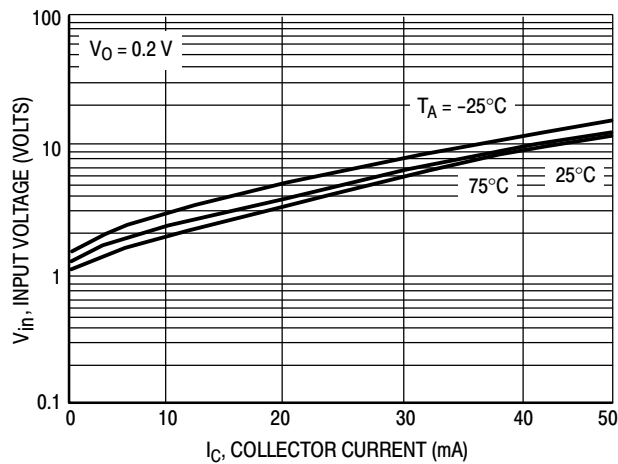

Figure 17. Input Voltage versus Output Current

DTC114EET1 Series, SDTC114EET1 Series

TYPICAL ELECTRICAL CHARACTERISTICS - DTC144EET1



Figure 18. $V_{CE(sat)}$ versus I_C



Figure 19. DC Current Gain



Figure 20. Output Capacitance



Figure 21. Output Current versus Input Voltage

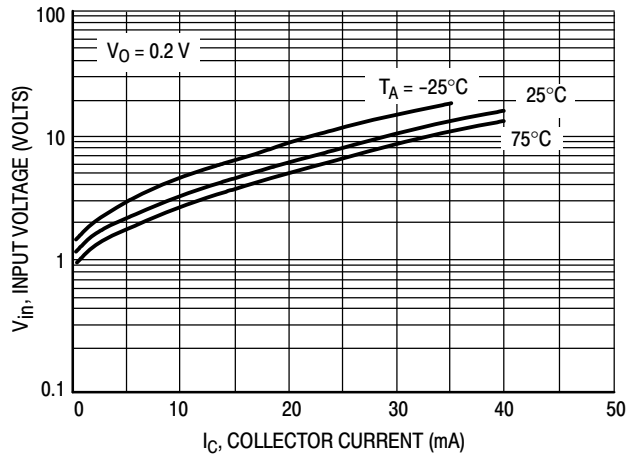

Figure 22. Input Voltage versus Output Current

DTC114EET1 Series, SDTC114EET1 Series

TYPICAL ELECTRICAL CHARACTERISTICS – DTC114YET1, SDTC114YET1

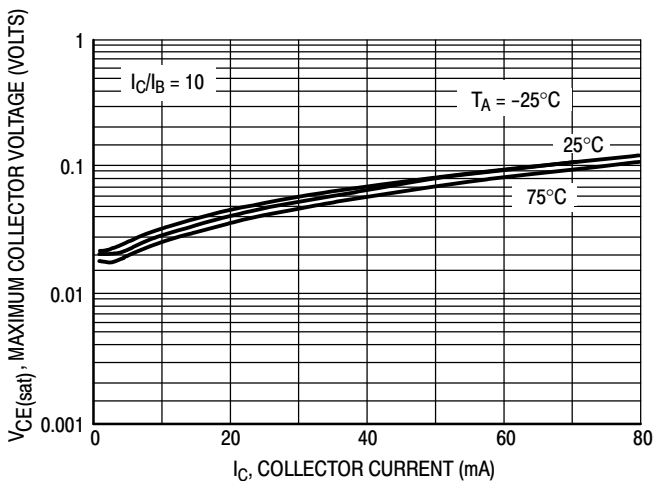

Figure 23. $V_{CE(sat)}$ versus I_C

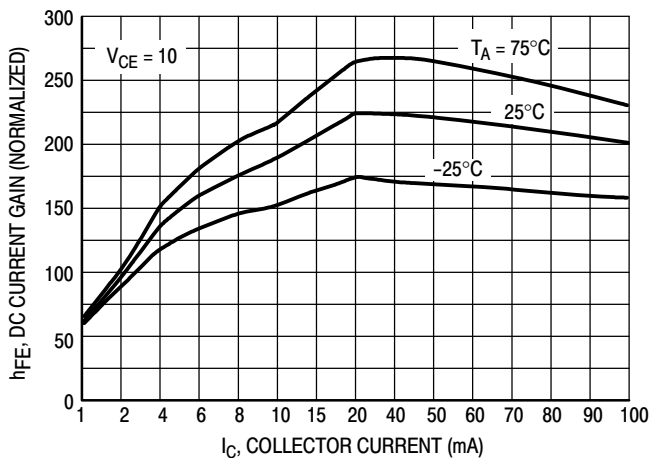

Figure 24. DC Current Gain

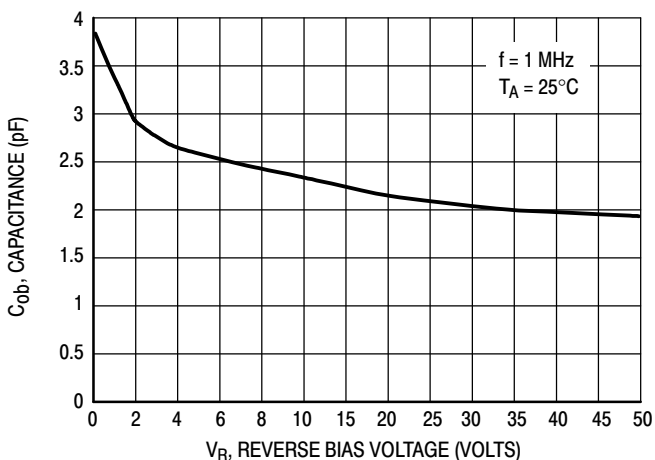

Figure 25. Output Capacitance

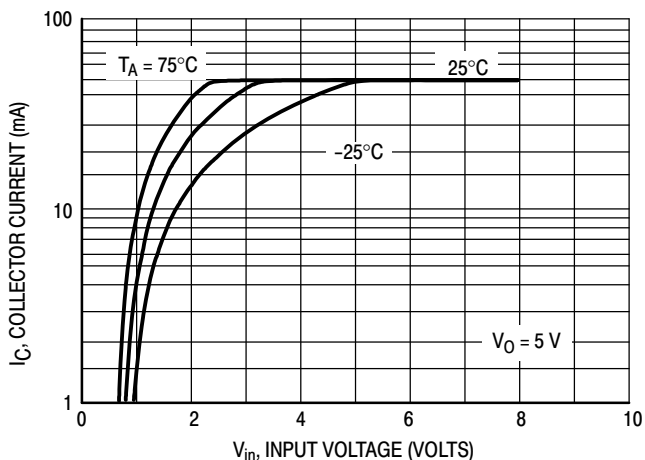

Figure 26. Output Current versus Input Voltage

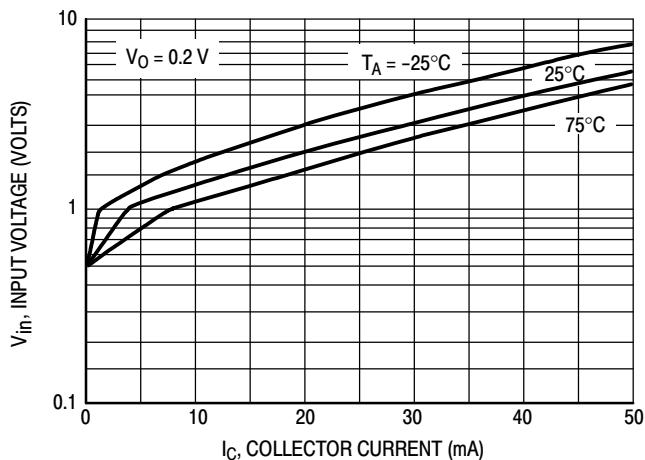

Figure 27. Input Voltage versus Output Current

DTC114EET1 Series, SDTC114EET1 Series

TYPICAL ELECTRICAL CHARACTERISTICS – DTC123JET1G

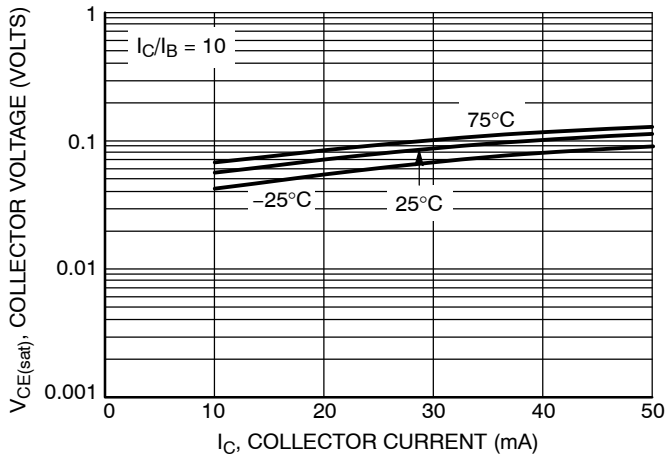

Figure 28. $V_{CE(sat)}$ versus I_C

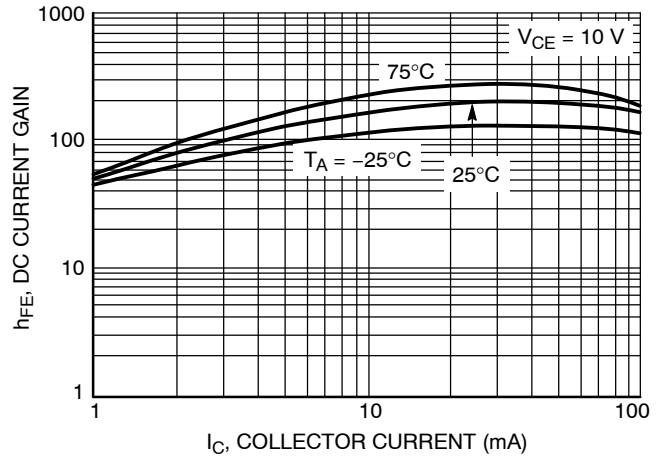

Figure 29. DC Current Gain

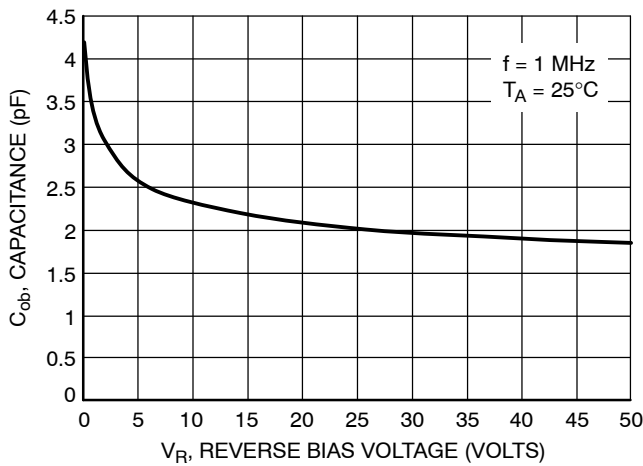

Figure 30. Output Capacitance

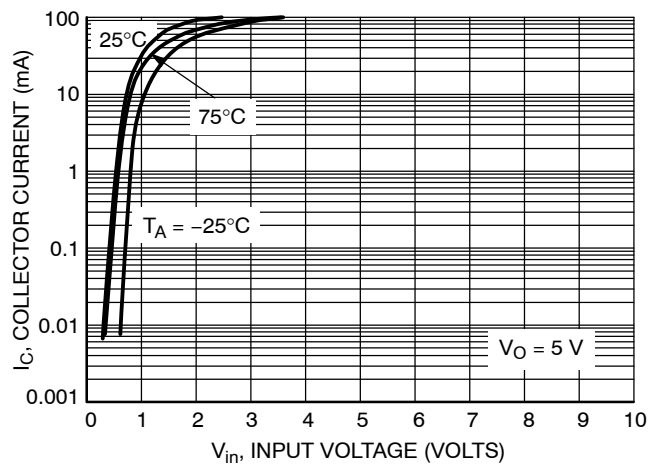

Figure 31. Output Current versus Input Voltage

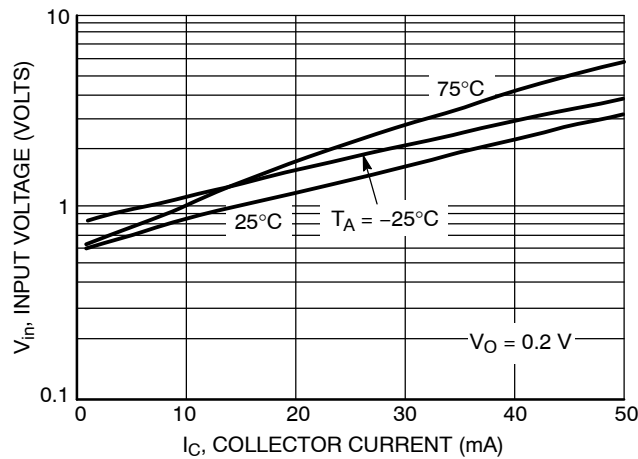

Figure 32. Input Voltage versus Output Current

DTC114EET1 Series, SDTC114EET1 Series

TYPICAL ELECTRICAL CHARACTERISTICS - DTC143ZET1

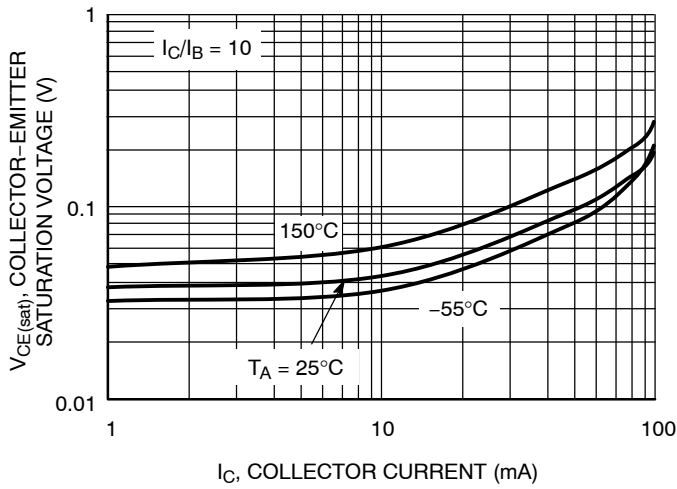

Figure 33. $V_{CE(sat)}$ versus I_C

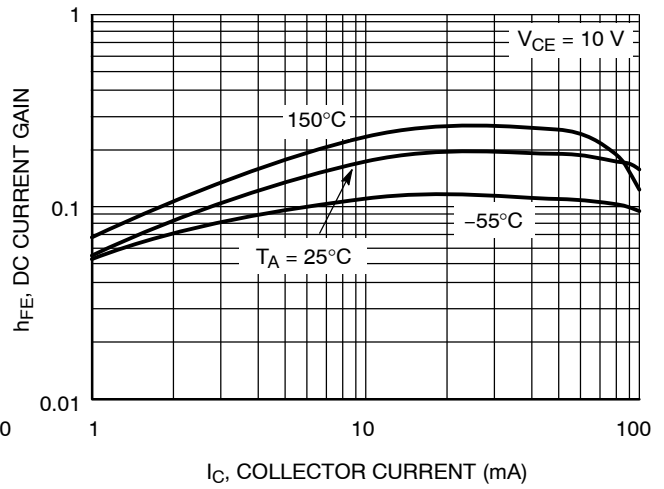

Figure 34. DC Current Gain

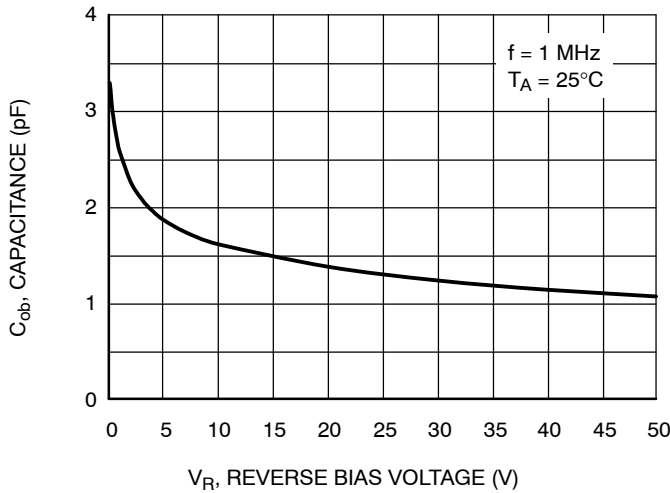

Figure 35. Output Capacitance

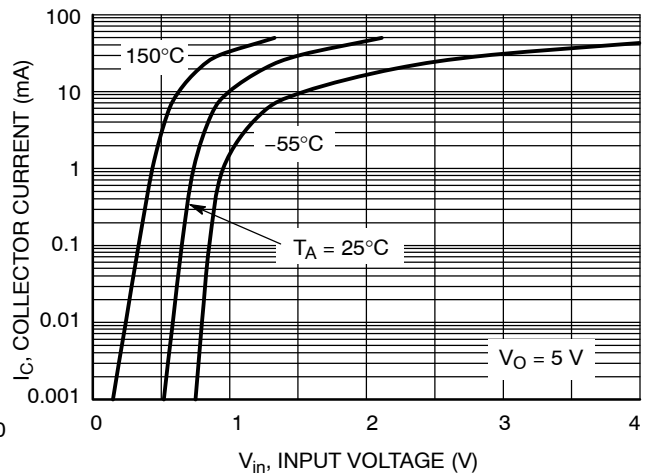

Figure 36. Output Current versus Input Voltage

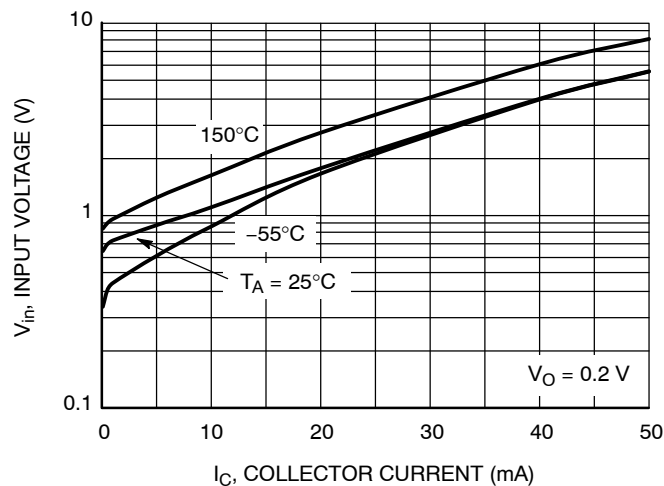

Figure 37. Input Voltage versus Output Current

DTC114EET1 Series, SDTC114EET1 Series

TYPICAL APPLICATIONS FOR NPN BRTs

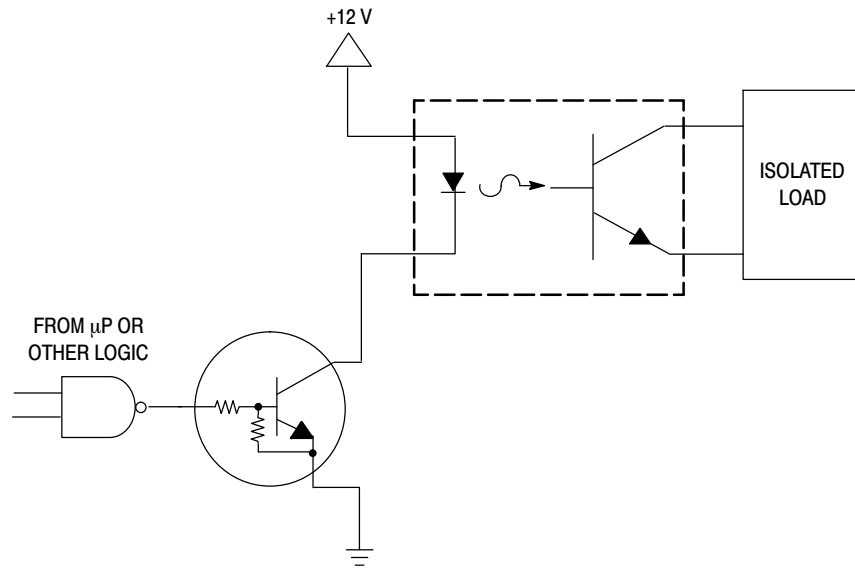

Figure 38. Level Shifter: Connects 12 or 24 Volt Circuits to Logic



Figure 39. Open Collector Inverter: Inverts the Input Signal

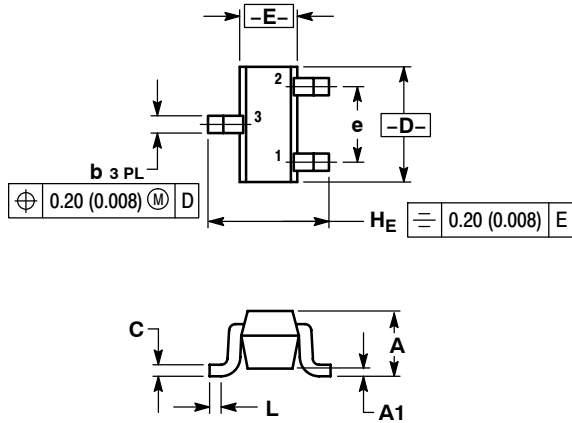

Figure 40. Inexpensive, Unregulated Current Source

DTC114EET1 Series, SDTC114EET1 Series

PACKAGE DIMENSIONS

SC-75/SOT-416
CASE 463
ISSUE F



NOTES:

1. DIMENSIONING AND TOLERANCING PER ANSI Y14.5M, 1982.
2. CONTROLLING DIMENSION: MILLIMETER.

DIM	MILLIMETERS			INCHES		
	MIN	NOM	MAX	MIN	NOM	MAX
A	0.70	0.80	0.90	0.027	0.031	0.035
A1	0.00	0.05	0.10	0.000	0.002	0.004
b	0.15	0.20	0.30	0.006	0.008	0.012
C	0.10	0.15	0.25	0.004	0.006	0.010
D	1.55	1.60	1.65	0.059	0.063	0.067
E	0.70	0.80	0.90	0.027	0.031	0.035
e	1.00 BSC			0.04 BSC		
L	0.10	0.15	0.20	0.004	0.006	0.008
HE	1.50	1.60	1.70	0.061	0.063	0.065

STYLE 1:

1. BASE
2. EMITTER
3. COLLECTOR

SOLDERING FOOTPRINT*

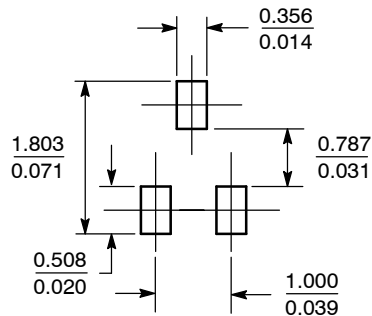

SCALE 10:1 ($\frac{\text{mm}}{\text{inches}}$)

*For additional information on our Pb-Free strategy and soldering details, please download the ON Semiconductor Soldering and Mounting Techniques Reference Manual, SOLDERRM/D.

ON Semiconductor and are registered trademarks of Semiconductor Components Industries, LLC (SCILLC). SCILLC reserves the right to make changes without further notice to any products herein. SCILLC makes no warranty, representation or guarantee regarding the suitability of its products for any particular purpose, nor does SCILLC assume any liability arising out of the application or use of any product or circuit, and specifically disclaims any and all liability, including without limitation special, consequential or incidental damages. "Typical" parameters which may be provided in SCILLC data sheets and/or specifications can and do vary in different applications and actual performance may vary over time. All operating parameters, including "Typicals" must be validated for each customer application by customer's technical experts. SCILLC does not convey any license under its patent rights nor the rights of others. SCILLC products are not designed, intended, or authorized for use as components in systems intended for surgical implant into the body, or other applications intended to support or sustain life, or for any other application in which the failure of the SCILLC product could create a situation where personal injury or death may occur. Should Buyer purchase or use SCILLC products for any such unintended or unauthorized application, Buyer shall indemnify and hold SCILLC and its officers, employees, subsidiaries, affiliates, and distributors harmless against all claims, costs, damages, and expenses, and reasonable attorney fees arising out of, directly or indirectly, any claim of personal injury or death associated with such unintended or unauthorized use, even if such claim alleges that SCILLC was negligent regarding the design or manufacture of the part. SCILLC is an Equal Opportunity/Affirmative Action Employer. This literature is subject to all applicable copyright laws and is not for resale in any manner.

PUBLICATION ORDERING INFORMATION

LITERATURE FULFILLMENT:
Literature Distribution Center for ON Semiconductor
P.O. Box 5163, Denver, Colorado 80217 USA
Phone: 303-675-2175 or 800-344-3860 Toll Free USA/Canada
Fax: 303-675-2176 or 800-344-3867 Toll Free USA/Canada
Email: orderlit@onsemi.com

N. American Technical Support: 800-282-9855 Toll Free
USA/Canada
Europe, Middle East and Africa Technical Support:
Phone: 421 33 790 2910
Japan Customer Focus Center
Phone: 81-3-5817-1050

ON Semiconductor Website: www.onsemi.com
Order Literature: <http://www.onsemi.com/orderlit>

For additional information, please contact your local Sales Representative

Компания «Океан Электроники» предлагает заключение долгосрочных отношений при поставках импортных электронных компонентов на взаимовыгодных условиях!

Наши преимущества:

- Поставка оригинальных импортных электронных компонентов напрямую с производств Америки, Европы и Азии, а так же с крупнейших складов мира;
- Широкая линейка поставок активных и пассивных импортных электронных компонентов (более 30 млн. наименований);
- Поставка сложных, дефицитных, либо снятых с производства позиций;
- Оперативные сроки поставки под заказ (от 5 рабочих дней);
- Экспресс доставка в любую точку России;
- Помощь Конструкторского Отдела и консультации квалифицированных инженеров;
- Техническая поддержка проекта, помощь в подборе аналогов, поставка прототипов;
- Поставка электронных компонентов под контролем ВП;
- Система менеджмента качества сертифицирована по Международному стандарту ISO 9001;
- При необходимости вся продукция военного и аэрокосмического назначения проходит испытания и сертификацию в лаборатории (по согласованию с заказчиком);
- Поставка специализированных компонентов военного и аэрокосмического уровня качества (Xilinx, Altera, Analog Devices, Intersil, Interpoint, Microsemi, Actel, Aeroflex, Peregrine, VPT, Syfer, Eurofarad, Texas Instruments, MS Kennedy, Miteq, Cobham, E2V, MA-COM, Hittite, Mini-Circuits, General Dynamics и др.);

Компания «Океан Электроники» является официальным дистрибьютором и эксклюзивным представителем в России одного из крупнейших производителей разъемов военного и аэрокосмического назначения «JONHON», а так же официальным дистрибьютором и эксклюзивным представителем в России производителя высокотехнологичных и надежных решений для передачи СВЧ сигналов «FORSTAR».



JONHON

«JONHON» (основан в 1970 г.)

Разъемы специального, военного и аэрокосмического назначения:

(Применяются в военной, авиационной, аэрокосмической, морской, железнодорожной, горно- и нефтедобывающей отраслях промышленности)

«FORSTAR» (основан в 1998 г.)

ВЧ соединители, коаксиальные кабели, кабельные сборки и микроволновые компоненты:

(Применяются в телекоммуникациях гражданского и специального назначения, в средствах связи, РЛС, а так же военной, авиационной и аэрокосмической отраслях промышленности).



Телефон: 8 (812) 309-75-97 (многоканальный)

Факс: 8 (812) 320-03-32

Электронная почта: ocean@oceanchips.ru

Web: <http://oceanchips.ru/>

Адрес: 198099, г. Санкт-Петербург, ул. Калинина, д. 2, корп. 4, лит. А