

SMD TCXO/VCTCXO

ASTXR-12



ESD Sensitive



RoHS / RoHS II Compliant



2.5 x 2.0 x 0.9mm

Moisture Sensitivity Level (MSL) – 1

OVERVIEW:

Abrakon's ASTXR series of Temperature Compensated Crystal Oscillators are based on an Advanced-Analog Temperature Compensation Integrated Circuit, incorporated with Rakon's Precision TCXO processing techniques.

This composite enables exceptional frequency stability over temperature ($\leq \pm 0.50$ ppm over -40°C to $+85^{\circ}\text{C}$). Additionally, high-resolution screening algorithms are employed during the production verification process, ensuring that 100% of these devices are fully compliant to the stringent frequency stability specifications.

For Power Sensitive applications, the ASTXR series provides the ability to preserve consumed power by placing the device in shut-down mode; when not used. This series of devices are ideally suited for GPS and other mobile applications where performance, size, cost and power management are of critical importance

FEATURES:

- Excellent phase noise performance
- Low power consumption
- Miniature size: 2.5 x 2.0 x 0.9mm
- RoHS compliant
- Temperature stability choices are ± 0.5 ppm to ± 2.5 ppm depending on operating temperature range

APPLICATIONS:

- GPS
- Smartphone
- PND
- Communications
- Consumer electronics
- Wi-Fi
- WiMAX/W-LAN

STANDARD SPECIFICATIONS:

Parameters	Minimum	Typical	Maximum	Units	Notes
Frequency Range	10		52	MHz	
Supply Voltage (Vdd)	1.8		3.3	V	
Current Consumption (@Vdd max)			2	mA	See Note 2
Operable Temperature Range	-40		+85	$^{\circ}\text{C}$	
Storage Temperature Range	-40		+85	$^{\circ}\text{C}$	
Initial Frequency Tolerance @ $+25^{\circ}\text{C} \pm 2^{\circ}\text{C}$ at time of shipment			± 1	ppm	
Reflow Drift			± 1	ppm	After 2 consecutive reflows and 1hr recovery@ $+25^{\circ}\text{C}$
Frequency Stability over Operating Temperature Range	± 0.5		± 2.5	ppm	Ref. to $(F_{\text{MAX}} + F_{\text{MIN}})/2$. Vc is set to midpoint of control voltage range See Note 1
Frequency Slope (tested to a minimum of 1 freq. reading every 2°C over operating temperature range)	0.1		1	ppm/ $^{\circ}\text{C}$	See Note 1
Static Temperature Hysteresis (Frequency change after reciprocal temperature ramped over the operating range. Frequency measured before and after at $+25^{\circ}\text{C}$)			0.6	ppm	
Sensitivity vs. Supply Voltage Variations (Vdd $\pm 5\%$ @ $+25^{\circ}\text{C}$)			± 0.1	ppm	
Sensitivity vs. Load Variations ($\pm 10\%$ load change @ $+25^{\circ}\text{C}$)			± 0.2	ppm	See Note 2
Long Term Stability (frequency drift over 1 year @ $+25^{\circ}\text{C}$)			± 1	ppm	
Output Type	DC Coupled Clipped Sine-wave				See Note 3
Output Voltage Level (@ minimum Vdd)	0.8			V	See Note 2
Output Load Resistance	9	10	11	k Ω	
Output Load Capacitance	9	10	11	pF	
Startup Time (amplitude)			0.5	ms	Within 90% of specified output level
Startup Time (frequency)			2	ms	Within ± 0.5 ppm of steady state frequency

ABRACON IS
ISO9001:2008
CERTIFIED



ABRACON
CORPORATION

Visit www.abracon.com for Terms & Conditions of Sale

30332 Esperanza, Rancho Santa Margarita, California 92688

tel 949-546-8000 | fax 949-546-8001 | www.abracon.com

Revised: 07.06.14

SMD TCXO/VCTCXO

ASTXR-12



RoHS / RoHS II Compliant



2.5 x 2.0 x 0.9mm

Parameters		Minimum	Typical	Maximum	Units	Notes
Enable/Disable Function						
Input Voltage High (VIH)		80%*Vdd		Vdd	V	Normal operating Mode
Input Voltage Low (VIL)		GND		20%*Vdd	V	Power Down Mode
Stand-by Current			<0.01	1	µA	
Enable Time (amplitude)				0.5	ms	Within 90% of specified output level
Enable Time (frequency)				2	ms	Within ±0.5ppm of steady state frequency
Control Voltage Range (Vc)	Vdd ≤ 2.3V	0.3		1.5	V	The nominal Vc value is midway between the min and max. Vc should not exceed Vdd+0.2V or GND
	Vdd > 2.3V	0.4		2.4	V	
Frequency Tuning		±10			ppm	Freq. shift from min to max of control voltages
Control Voltage Input Port Impedance			500		kΩ	
Phase Noise @ 26MHz Carrier (@+25°C)						
@ 1	Hz offset		-65		dBc / Hz	
@ 10	Hz offset		-93		dBc / Hz	
@ 100	Hz offset		-117		dBc / Hz	
@ 1,000	Hz offset		-137		dBc / Hz	
@ 10,000	Hz offset		-149		dBc / Hz	
@ 100,000	Hz offset		-151		dBc / Hz	

Note:

- Parts should be shielded from drafts causing unexpected thermal gradients. Temperature changes due to ambient air currents on the oscillator can lead to short term frequency drift
- Specified for load stated in the Oscillator Output section at +25°C
- External AC-Coupling capacitor required. ≥ 1nF is recommended
- Frequency shift ≤ 1ppm after reliability test conditions (see section 7.0)

PART IDENTIFICATIONS:



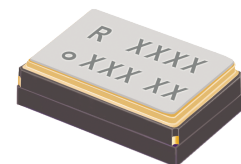

2.5 x 2.0 x 0.9mm

Table of Available Configurations

Abracon P/N	Freq. Stability Over Temperature (ppm)	Slope (ppm/°C)	Operating Temperature (°C)	Supply Voltage (V)	Enable/Disable	Temp. Sensor	Voltage Control
ASTXR-12-26.000MHz-508892	± 0.5	± 0.1	-30 to +85	1.8 V	no	no	no
ASTXR-12-26.000MHz-512883	± 0.5	± 0.1	-30 to +85	1.8 V	no	no	no
ASTXR-12-16.369MHz-508303	± 0.5	± 0.1	-40 to +85	1.8 V	Pin 1	no	no
ASTXR-12-16.369MHz-508314	± 0.5	± 0.1	-30 to +85	1.8 V	Pin 2	no	no
ASTXR-12-16.369MHz-511743	± 0.5	± 0.1	-40 to +85	1.8 V	Pin 1	no	no
ASTXR-12-16.369MHz-512543	± 0.5	± 0.1	-40 to +85	1.8 V	Pin 2	Pin 5	no
ASTXR-12-19.200MHz-512544	± 0.5	± 0.1	-40 to +85	1.8 V	Pin 2	Pin 5	no
ASTXR-12-26.000MHz-508139	± 0.5	± 0.1	-40 to +85	1.8 V	Pin 1	no	no
ASTXR-12-26.000MHz-508313	± 0.5	± 0.1	-40 to +85	1.8 V	Pin 2	no	no
ASTXR-12-26.000MHz-509161	± 0.5	± 0.1	-40 to +85	1.8 V	Pin 2	Pin 1	no
ASTXR-12-26.000MHz-511741	± 0.5	± 0.1	-40 to +85	1.8 V	Pin 1	no	no





Table of Available Configurations (continued)

Abracon P/N	Freq. Stability Over Temperature (ppm)	Slope (ppm/°C)	Operating Temperature (°C)	Supply Voltage (V)	Enable/Disable	Temp. Sensor	Voltage Control
ASTXR-12-26.000MHz-512545	± 0.5	± 0.1	-40 to +85	1.8 V	Pin 2	Pin 5	no
ASTXR-12-19.200MHz-508072	± 0.5	± 0.1	-30 to +85	1.8 V	no	no	no
ASTXR-12-19.200MHz-508207	± 0.5	± 0.1	-30 to +85	2.85 V	no	no	no
ASTXR-12-19.200MHz-512242	± 0.5	± 0.1	-30 to +85	1.8 V	no	no	no
ASTXR-12-19.200MHz-508221	± 0.5	± 0.1	-30 to +85	1.8 V	no	no	yes
ASTXR-12-19.200MHz-508220	± 0.5	± 0.1	-30 to +85	2.85 V	no	no	yes
ASTXR-12-19.200MHz-503461	± 0.5	± 0.1	-30 to +85	2.85 V	no	no	yes
ASTXR-12-19.200MHz-512222	± 0.5	± 0.1	-30 to +85	2.85 V	no	no	yes
ASTXR-12-19.200MHz-512240	± 0.5	± 0.1	-30 to +85	1.8 V	no	no	yes
ASTXR-12-19.200MHz-511890	± 0.5	± 0.1	-30 to +85	2.85 V	no	no	no
ASTXR-12-26.000MHz-504670	± 0.5	± 0.1	-30 to +85	3.0 V	no	no	no
ASTXR-12-26.000MHz-511911	± 0.5	± 0.1	-30 to +85	1.88 V	Pin 1	no	no
ASTXR-12-26.000MHz-503820	± 0.5	± 0.1	-30 to +85	1.9 V	Pin 2	no	no
ASTXR-12-16.369MHz-505160	± 0.5	± 0.1	-30 to +85	2.85 V	no	no	no
ASTXR-12-16.369MHz-506439	± 0.5	± 0.1	-30 to +85	1.8 V	Pin 2	no	no
ASTXR-12-26.000MHz-513028	± 0.5	± 0.1	-30 to +85	1.8 V	no	no	yes



SMD TCXO/VCTCXO

ASTXR-12



RoHS / RoHS II Compliant



2.5 x 2.0 x 0.9mm

REFERENCE DESIGN INFORMATION:

Abrakon P/N	Equivalent Rakon P/N	Recommended Alternative	Chipset	Reference Design Chipset P/N
ASTXR-12-26.000MHz-508892	508892	512883	Broadcom	BCM2075, BCM2076, BCM4750, BCM4751, BCM47511, BCM4752, BCM47521, BCM4760
ASTXR-12-26.000MHz-512883	512883		Broadcom	BCM2075, BCM2076, BCM4750, BCM4751, BCM47511, BCM4752, BCM47521, BCM4760
ASTXR-12-16.369MHz-508303	508303	511743	CSR	SirfStar 3 (SS3), SirfStar 4 (SS4), SirfStar 5 (SS5)
ASTXR-12-16.369MHz-508314	508314	511743	CSR	SirfStar 3 (SS3), SirfStar 4 (SS4), SirfStar 5 (SS5)
ASTXR-12-16.369MHz-511743	511743		CSR	SirfStar 3 (SS3), SirfStar 4 (SS4), SirfStar 5 (SS5)
ASTXR-12-16.369MHz-512543	512543		CSR	SirfStar 5 (SS5)
ASTXR-12-19.200MHz-512544	512544		CSR	SirfStar 5 (SS5)
ASTXR-12-26.000MHz-508139	508139	511741	CSR	SirfStar 3 (SS3), SirfStar 4 (SS4), SirfStar 5 (SS5)
ASTXR-12-26.000MHz-508313	508313	511741	CSR	SirfStar 3 (SS3), SirfStar 4 (SS4), SirfStar 5 (SS5)
ASTXR-12-26.000MHz-509161	509161	512545	CSR	SirfStar 5 (SS5)
ASTXR-12-26.000MHz-511741	511741		CSR	SirfStar 3 (SS3), SirfStar 4 (SS4), SirfStar 5 (SS5)
ASTXR-12-26.000MHz-512545	512545		CSR	SirfStar 5 (SS5)
ASTXR-12-19.200MHz-508072	508072	512242	Qualcomm	APQ Family, APQ8064
ASTXR-12-19.200MHz-508207	508207	511890	Qualcomm	APQ Family, APQ8064
ASTXR-12-19.200MHz-512242	512242		Qualcomm	APQ Family, APQ8064





2.5 x 2.0 x 0.9mm

REFERENCE DESIGN INFORMATION CONTD:

Abrakon P/N	Equivalent Rakon P/N	Recommended Alternative	Chipset	Reference Design Chipset P/N
ASTXR-12-19.200MHz-508221	508221	512240	Qualcomm	MDM Family, MDM6xxx, MDM7xxx, MDM8xxx, MDM6085, MDM6270, MDM6200, MDM6600, MDM8200A, MDM8220, MDM8215, MDM8229
ASTXR-12-19.200MHz-508220	508220	512222	Qualcomm	MDM Family, MDM6xxx, MDM7xxx, MDM8xxx, MDM6085, MDM6270, MDM6200, MDM6600, MDM8200A, MDM8220, MDM8215, MDM8230
ASTXR-12-19.200MHz-503461	503461	512222	Qualcomm	MDM Family, MDM6xxx, MDM7xxx, MDM8xxx, MDM6085, MDM6270, MDM6200, MDM6600, MDM8200A, MDM8220, MDM8215, MDM8231
ASTXR-12-19.200MHz-512222	512222		Qualcomm	MDM Family, MDM6xxx, MDM7xxx, MDM8xxx, MDM6085, MDM6270, MDM6200, MDM6600, MDM8200A, MDM8220, MDM8215, MDM8225
ASTXR-12-19.200MHz-512240	512240		Qualcomm	MDM Family, MDM6xxx, MDM7xxx, MDM8xxx, MDM6085, MDM6270, MDM6200, MDM6600, MDM8200A, MDM8220, MDM8215, MDM8226
ASTXR-12-19.200MHz-511890	511890		Qualcomm	APQ Family, APQ8064
ASTXR-12-26.000MHz-504670	504670	511911	uBlox	u-blox 6 (UBX-M6000, UBX-M6010), u-blox 7 (UBX-M7020), u-blox 8 (UBX-M8030)
ASTXR-12-26.000MHz-511911	511911		uBlox	u-blox 6 (UBX-M6000, UBX-M6010), u-blox 7 (UBX-M7020), u-blox 8 (UBX-M8030)
ASTXR-12-26.000MHz-503820	503820	511911	uBlox	u-blox 6 (UBX-M6000, UBX-M6010), u-blox 7 (UBX-M7020), u-blox 8 (UBX-M8030)
ASTXR-12-16.369MHz-505160	505160	511743		
ASTXR-12-16.369MHz-506439	506439	511743		
ASTXR-12-26.000MHz-513028	513028			

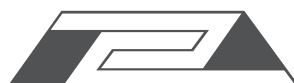

SMD TCXO/VCTCXO

ASTXR-12



RoHS / RoHS II Compliant

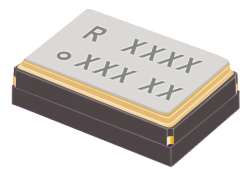

2.5 x 2.0 x 0.9mm

OUTLINE DIMENSION:



TOP VIEW



FRONT VIEW



BOTTOM VIEW

Recommended Land Pattern

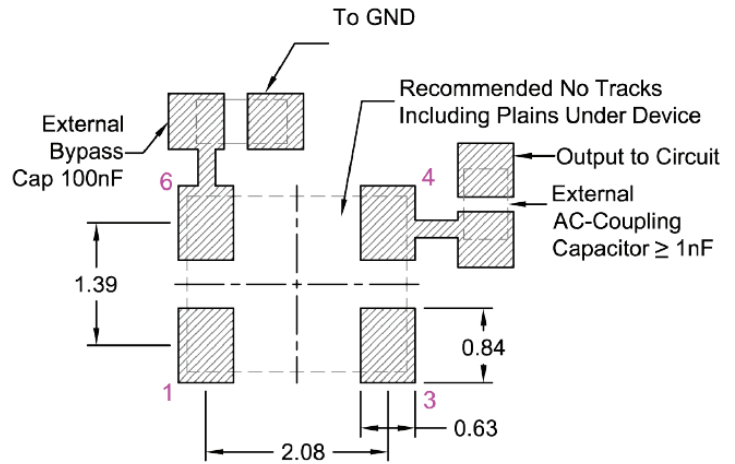

Pin	Function
1	NC/GND Enable/Disable Vc
2	NC/GND
3	GND
4	Output
5	NC/GND
6	Vdd

Dimensions: mm

REFLOW PROFILE:

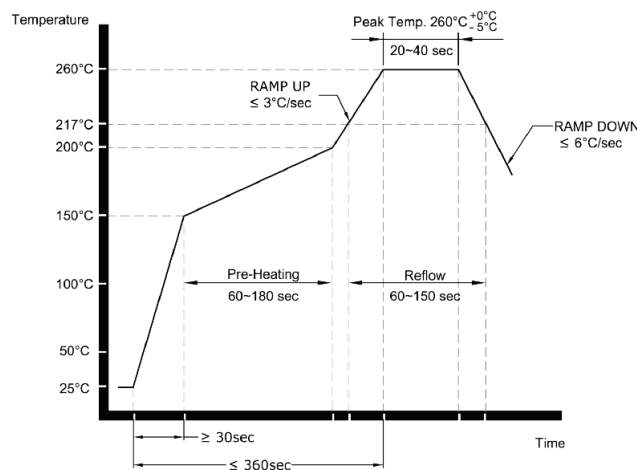

ABRACON IS
ISO9001:2008
CERTIFIED



ABRACON
CORPORATION

Visit www.abracon.com for Terms & Conditions of Sale
30332 Esperanza, Rancho Santa Margarita, California 92688
tel 949-546-8000 | fax 949-546-8001 | www.abracon.com

Revised: 07.06.14

SMD TCXO/VCTCXO

ASTXR-12



RoHS / RoHS II Compliant

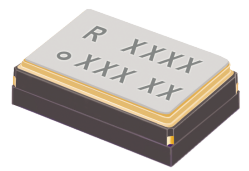

2.5 x 2.0 x 0.9mm

TAPE & REEL:

3000pcs/reel

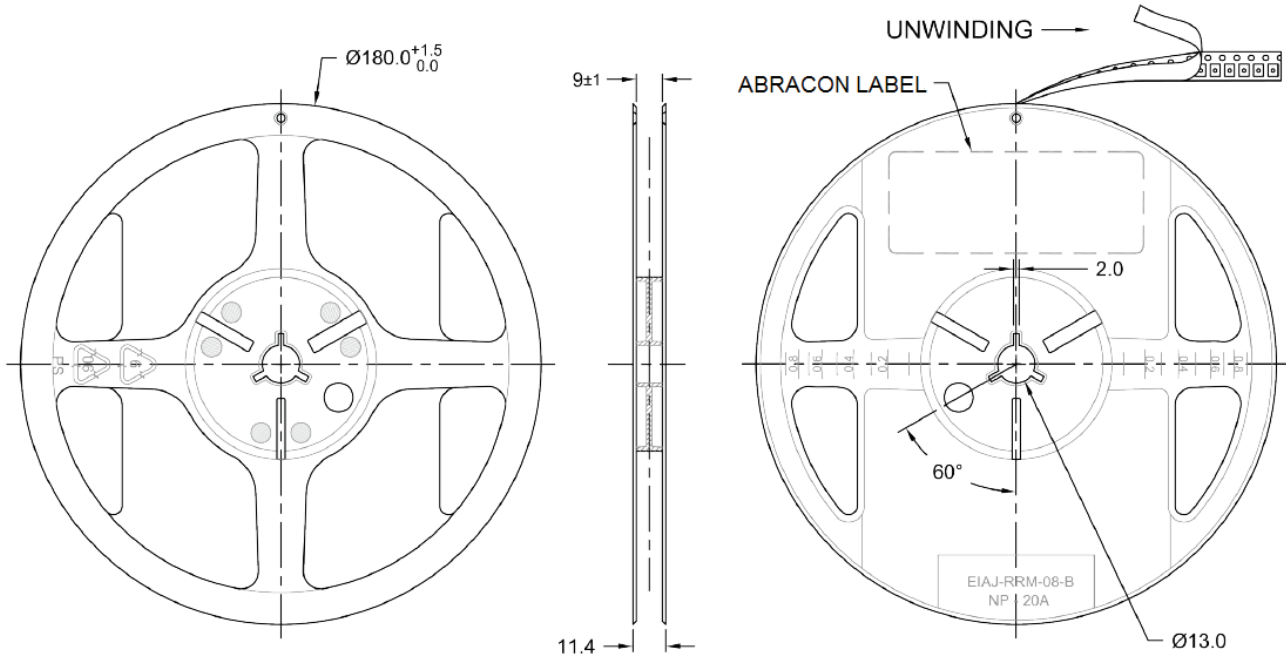
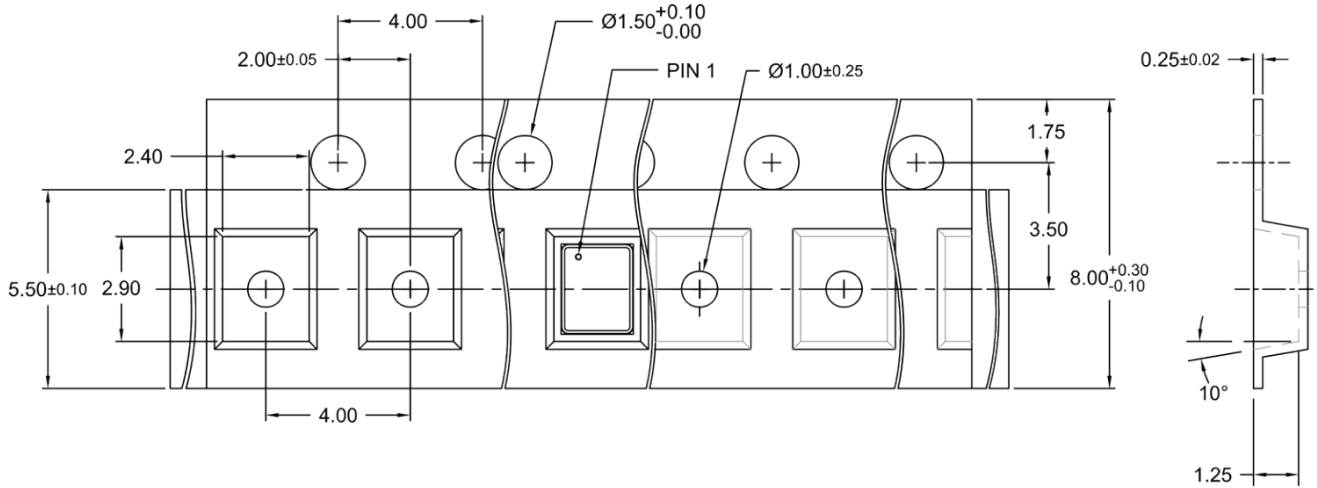

Dimensions: mm

ATTENTION: Abracon Corporation's products are COTS – Commercial-Off-The-Shelf products; suitable for Commercial, Industrial and, where designated, Automotive Applications. Abracon's products are not specifically designed for Military, Aviation, Aerospace, Life-dependant Medical applications or any application requiring high reliability where component failure could result in loss of life and/or property. For applications requiring high reliability and/or presenting an extreme operating environment, written consent and authorization from Abracon Corporation is required. Please contact Abracon Corporation for more information.

ABRACON IS
ISO9001:2008
CERTIFIED



**ABRACON
CORPORATION**

Visit www.abracon.com for Terms & Conditions of Sale

30332 Esperanza, Rancho Santa Margarita, California 92688
tel 949-546-8000 | fax 949-546-8001 | www.abracon.com

Revised: 07.06.14

Компания «Океан Электроники» предлагает заключение долгосрочных отношений при поставках импортных электронных компонентов на взаимовыгодных условиях!

Наши преимущества:

- Поставка оригинальных импортных электронных компонентов напрямую с производств Америки, Европы и Азии, а так же с крупнейших складов мира;
- Широкая линейка поставок активных и пассивных импортных электронных компонентов (более 30 млн. наименований);
- Поставка сложных, дефицитных, либо снятых с производства позиций;
- Оперативные сроки поставки под заказ (от 5 рабочих дней);
- Экспресс доставка в любую точку России;
- Помощь Конструкторского Отдела и консультации квалифицированных инженеров;
- Техническая поддержка проекта, помощь в подборе аналогов, поставка прототипов;
- Поставка электронных компонентов под контролем ВП;
- Система менеджмента качества сертифицирована по Международному стандарту ISO 9001;
- При необходимости вся продукция военного и аэрокосмического назначения проходит испытания и сертификацию в лаборатории (по согласованию с заказчиком);
- Поставка специализированных компонентов военного и аэрокосмического уровня качества (Xilinx, Altera, Analog Devices, Intersil, Interpoint, Microsemi, Actel, Aeroflex, Peregrine, VPT, Syfer, Eurofarad, Texas Instruments, MS Kennedy, Miteq, Cobham, E2V, MA-COM, Hittite, Mini-Circuits, General Dynamics и др.);

Компания «Океан Электроники» является официальным дистрибьютором и эксклюзивным представителем в России одного из крупнейших производителей разъемов военного и аэрокосмического назначения «JONHON», а так же официальным дистрибьютором и эксклюзивным представителем в России производителя высокотехнологичных и надежных решений для передачи СВЧ сигналов «FORSTAR».



JONHON

«JONHON» (основан в 1970 г.)

Разъемы специального, военного и аэрокосмического назначения:

(Применяются в военной, авиационной, аэрокосмической, морской, железнодорожной, горно- и нефтедобывающей отраслях промышленности)

«FORSTAR» (основан в 1998 г.)

ВЧ соединители, коаксиальные кабели,
кабельные сборки и микроволновые компоненты:

(Применяются в телекоммуникациях гражданского и специального назначения, в средствах связи, РЛС, а так же военной, авиационной и аэрокосмической отраслях промышленности).



Телефон: 8 (812) 309-75-97 (многоканальный)

Факс: 8 (812) 320-03-32

Электронная почта: ocean@oceanchips.ru

Web: <http://oceanchips.ru/>

Адрес: 198099, г. Санкт-Петербург, ул. Калинина, д. 2, корп. 4, лит. А