

MJTP SERIES 6MM THRU-HOLE MTG. TACT SWITCHES

FEATURES

- Numerous single pole-single throw momentary configurations.
- Excellent tactile feed-back (Snap dome).
- Ultra-compact size.
- Long operating life for high reliability.
- Molded-in terminals minimize wicking of flux or solder.

MATERIALS

Case:	Thermoplastic, color black. UL94HB Standard.
Actuator:	Thermoplastic
Cover/Bracket:	PET film, tin plated brass or stainless steel.
Terminals:	Silver plated brass.
Shorting Contact:	Phosphor bronze or stainless steel with silver plating.
L.E.D. rating:	Forward voltage- 2.1 V (3.0 V Max.). Cont. fwd. current 20mA max. @ 25°C.

Gold plating available on contacts & terminals - consult factory.

SPECIFICATIONS SUBJECT TO CHANGE WITHOUT NOTICE.

GENERAL SPECIFICATIONS

ELECTRICALS

Contact rating:	50 mA @ 12 VDC
Insulation resistance:	100 megohms min. (100 VDC)
Dielectric withstanding voltage:	250 VAC for 1 minute
Contact resistance:	100 milliohms max. @ 5 VDC, 10 mA
Electrical life:	100,000 cycles min. (except models MJTP1243 & 1250- 50,000 cycles) 1,000,000 cycles available - consult factory
Contact bounce:	less than 10 msec.

MECHANICALS, THERMALS, ENVIRONMENTALS

Plunger travel:	.010" + .008", - .004" (0,25 +0,2, -0,1 mm)
Actuation force:	160 grams ±30 grams
Operating temperature range:	-20°C to +70°C
Storage temperature range:	-30°C to +80°C for 96 hours
Shock resistance:	30G per method 213, MIL-STD-202
Vibration resistance:	passes method 201, MIL-STD-202

SOLDERING (note - non-washable except for models indicated 'process compatible' below).

IR reflow soldering:	240°C max. for 20 seconds max.
Wave soldering:	255°C max. for 5 seconds max.
Hand soldering:	320°C max. for 3.5 seconds max. (40 watt iron max.)

MJTP1105T

Right angle, grounding

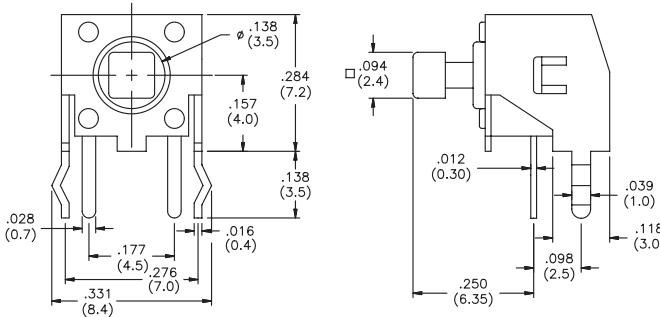

Caps available - see end of section.
Bulk packaged.

US # MJTP1109

EU # PHAP3350

Process compatible, grounding

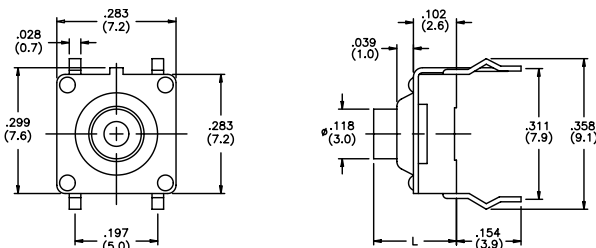

US Model No.	Dim. L (In./mm)	EU Model No.
MJTP1109	.197 (5.0)	PHAP3350
MJTP1109A	.354 (9.0)	PHAP3350A
MJTP1109B	.512 (13.0)	PHAP3350B

Bulk packaged.

US # MJTP1117
EU # PHAP3363
 Right angle,
 grounding



New!

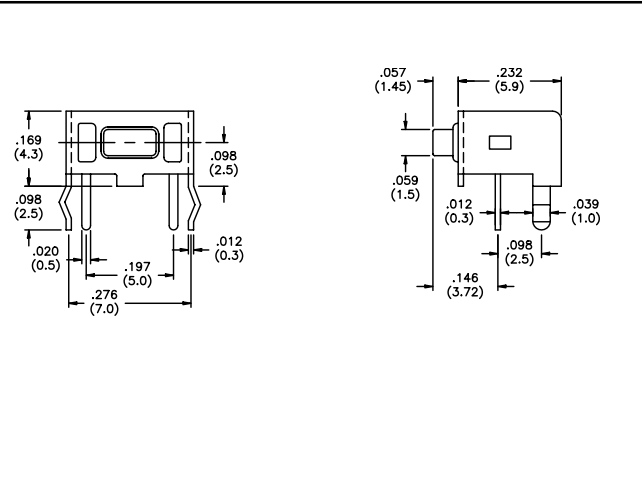

Bulk packaged.

US # MJTP1119
EU # PHAP3351
 Process compatible



New!

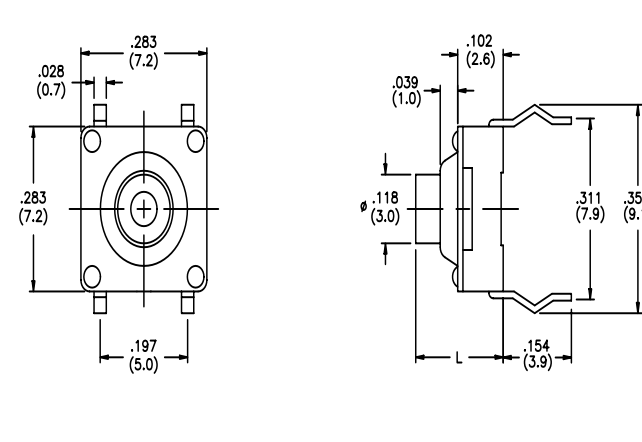

US Model No.	Dim. L (in./mm)	EU Model No.
MJTP1119	.197 (5.0)	PHAP3351
MJTP1119A	.354 (9.0)	PHAP3351A
MJTP1119B	.512 (13.0)	PHAP3351B

Bulk packaged.

US # MJTP1129
EU # PHAP1152
 Right angle,
 grounding,
 process compatible

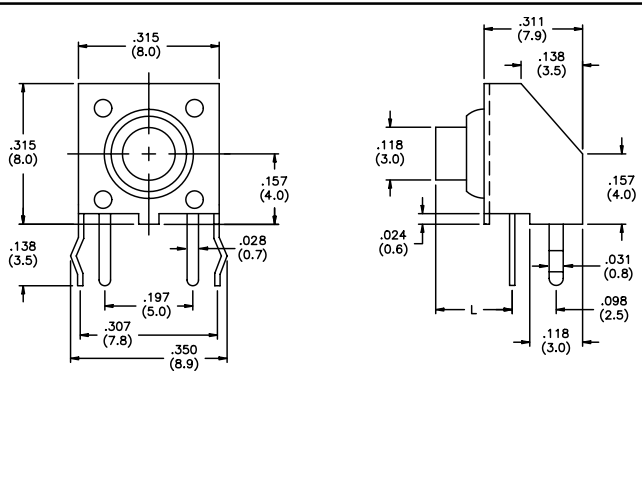

US Model No.	Dim. L (in./mm)	EU Model No.
MJTP1129	.171 (4.35)	PHAP3352
MJTP1129A	.329 (8.35)	PHAP3352A
MJTP1129B	.486 (12.35)	PHAP3352B

Bulk packaged.

US # MJTP1141
EU # PHAP3307
 Long terminals

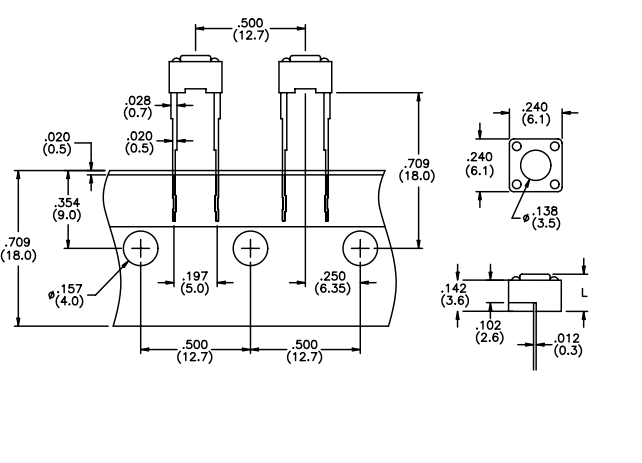

US Model No.	Dim. L (in./mm)	EU Model No.
MJTP1141	.169 (4.3)	PHAP3307
MJTP1141A	.197 (5.0)	PHAP3307A

Packaged on tape. Note: other models available with this tape packaging - consult factory.

SPECIFICATIONS SUBJECT TO CHANGE WITHOUT NOTICE.

US # MJTP1193
EU # PHAP3308
With L.E.D.



New!

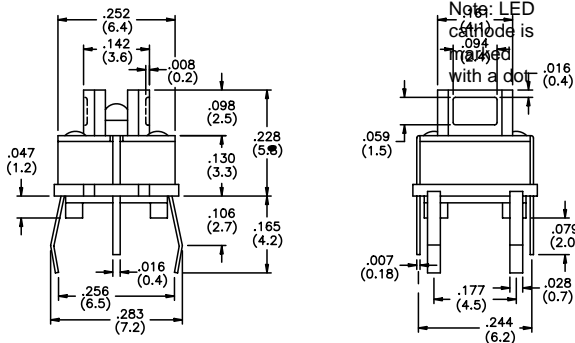

US Model No.	L.E.D. Color	EU Model No.
MJTP1193	No L.E.D.	PHAP3308
MJTP11936	Red	PHAP3308R
MJTP11935	Yellow	PHAP3308Y
MJTP11933	Green	PHAP3308G

Caps available with lens - see end of section.
Bulk packaged.

US # MJTP1230
EU # PHAP3301

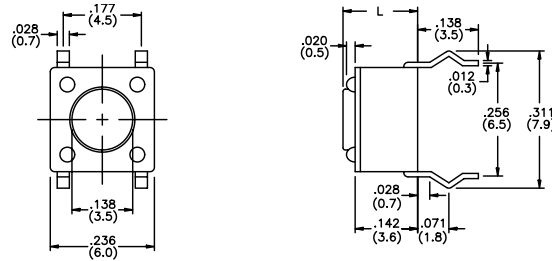

US Model No.	Dim. L (in./mm)	EU Model No.
MJTP1230	.170 (4,3)	PHAP3301
MJTP1230A	.197 (5,0)	PHAP3301A
MJTP1230B	.374 (9,5)	PHAP3301B
MJTP1230C	.315 (8,0)	PHAP3301C
MJTP1230D	.512 (13,0)	PHAP3301D
MJTP1230E	.287 (7,3)	PHAP3301E
MJTP1230F	.335 (8,5)	PHAP3301F
MJTP1230G	.275 (7,0)	N/A

Bulk packaged.

US # MJTP1232
EU # PHAP3302
Grounding

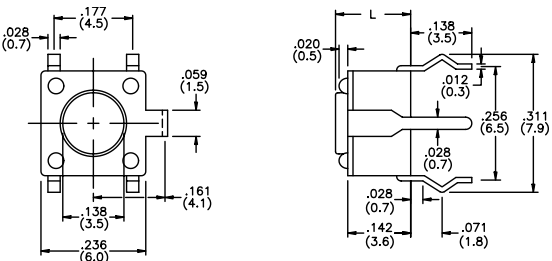

US Model No.	Dim. L (in./mm)	EU Model No.
MJTP1232	.170 (4,3)	PHAP3302
MJTP1232A	.197 (5,0)	PHAP3302A
MJTP1232B	.374 (9,5)	PHAP3302B
MJTP1232C	.315 (8,0)	PHAP3302C
MJTP1232D	.512 (13,0)	PHAP3302D
MJTP1232E	.287 (7,3)	PHAP3302E
MJTP1232F	.335 (8,5)	PHAP3302F
MJTP1232G	.275 (7,0)	PHAP3302G

Bulk packaged.

US # MJTP1234
EU # PHAP3303

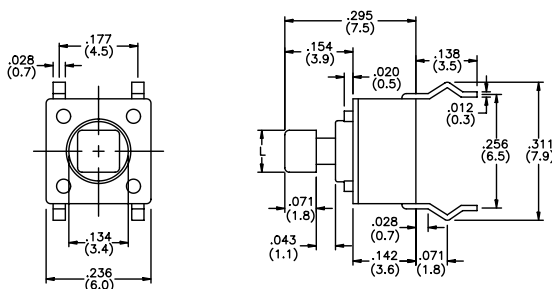

US Model No.	Dim. L (in./mm)	EU Model No.
MJTP1234	.094 (2,4)	PHAP3303
MJTP1234A	.110 (2,8)	PHAP3303A

Caps available - see end of section.
Bulk packaged.

US # MJTP1236
EU # PHAP3305
 Right angle,
 grounding

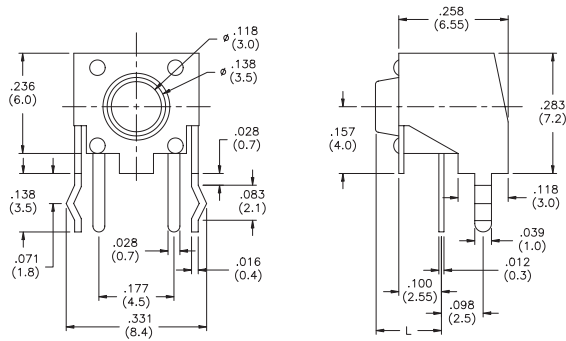

US Model No.	Dim. L (in./mm)	EU Model No.
MJTP1236	.124 (3,1)	PHAP3305
MJTP1236A	.152 (3,9)	PHAP3305A
MJTP1236B	.329 (8,4)	PHAP3305B
MJTP1236C	.270 (6,9)	PHAP3305C
MJTP1236D	.466 (11,9)	PHAP3305D
MJTP1236E	.244 (6,2)	PHAP3305E
MJTP1236F	.289 (7,3)	N/A
MJTP1236G	.230 (5,8)	N/A

Bulk packaged.

US # MJTP1243 & MJTP1250

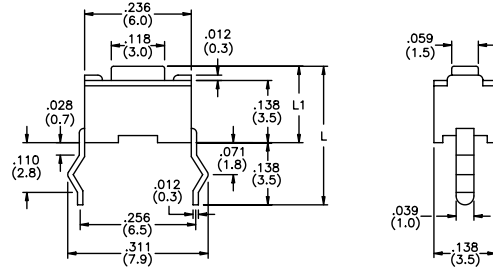

US # Model No.	Dim. L1 (in./mm)	Dim. L (in./mm)
MJTP1243	.169 (4,3)	.307 (7,8)
MJTP1250	.197 (5,0)	.335 (8,5)

Bulk packaged.

US # MJTP2205
EU # PHAP3306
 2 switch vertical
 gang assembly,
 black actuators

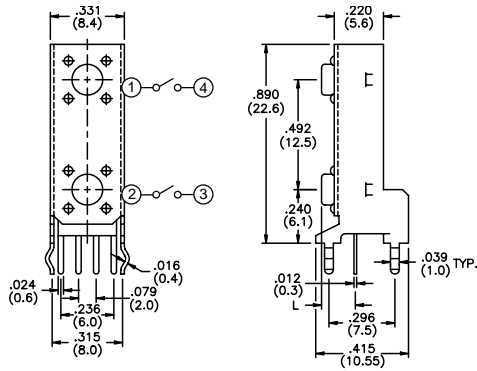

US Model No.	Dim. L (in./mm)	EU Model No.
MJTP2205	.124 (3,15)	PHAP3306
MJTP2205A	.152 (3,85)	PHAP3306A
MJTP2205B	.329 (8,35)	PHAP3306B
MJTP2205C	.270 (6,85)	PHAP3306C
MJTP2205D	.466 (11,85)	PHAP3306D
MJTP2205E	.242 (6,15)	PHAP3306E

Bulk packaged.

SPECIFICATIONS SUBJECT TO CHANGE WITHOUT NOTICE.

US # MJTPSHW
Process compatible

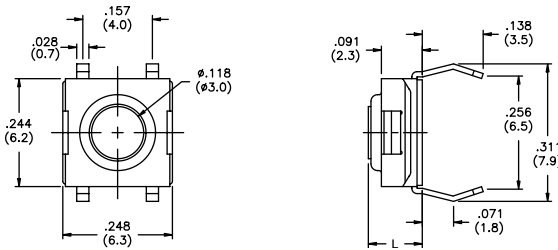

US # Model No.	Dim. L (in./mm)
MJTPSHW	.122 (3,1)
MJTPSHWA	.091 (2,3)
MJTPSHWB	.146 (3,8)

Bulk packaged.

CAPS (for MJTP1105T and MJTP1234 only)

CAPS (for MJTP1193 only)

New!

CAP COLORS

MJ61 Square cap

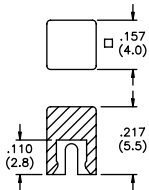

MJ62 Round cap

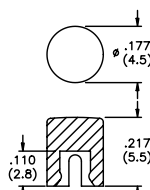

MJ3 Square cap (w/clear lens in center for LED illumination)

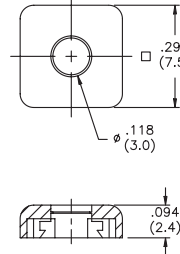

Note - add digit from table to cap part number for color. Example - **MJ612** indicates square black cap.

No.	Color
1	blue
2	black
3	green
5	yellow
6	red
7	ivory

SCHEMATICS

MJTP1109
MJTP1119
MJTP1193
MJTP1230
MJTP1232

MJTP1234
MJTP2205
MJTP4102
MJTP5302
MJTPSHW

Note: LED is for MJTP1193 only.

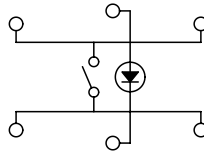

MJTP1105
MJTP1117
MJTP1129
MJTP1141
MJTP1144
MJTP1145

MJTP1236
MJTP1243
MJTP1250
MJTP2205
MJTP4102
MJTP5302

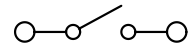

M

PRINTED CIRCUIT BOARD LAYOUTS

Layout tolerances; Linear: $\pm .004"$ ($\pm 0,1\text{MM}$) Holes: $\pm .002"$ ($\pm 0,05\text{MM}$)

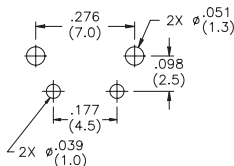

MJTP1105T

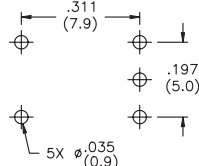

MJTP1109

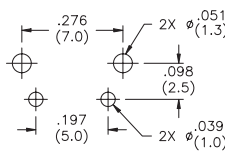

MJTP1117

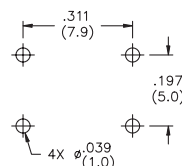

MJTP1119

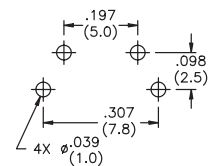

MJTP1129

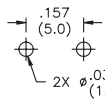

MJTP1141, 44 & 45

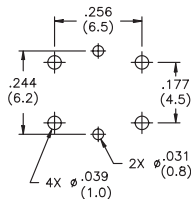

MJTP1193

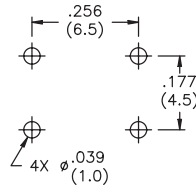

MJTP1230

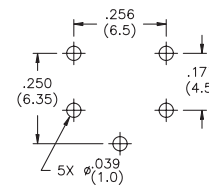

MJTP1232

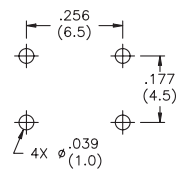

MJTP1234

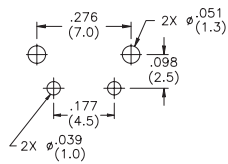

MJTP1236

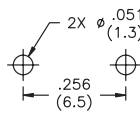

MJTP1243

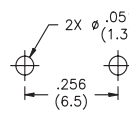

MJTP1250

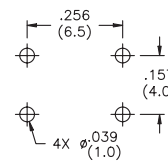

MJTPSHW

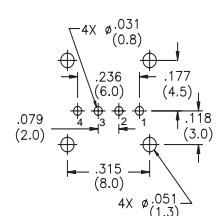

MJTP2205

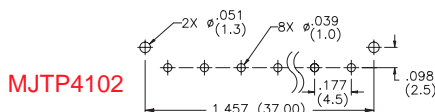

MJTP4102

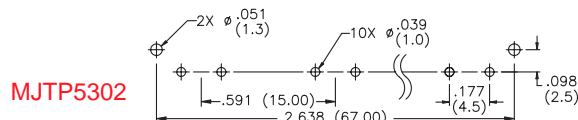

MJTP5302

Компания «Океан Электроники» предлагает заключение долгосрочных отношений при поставках импортных электронных компонентов на взаимовыгодных условиях!

Наши преимущества:

- Поставка оригинальных импортных электронных компонентов напрямую с производств Америки, Европы и Азии, а так же с крупнейших складов мира;
- Широкая линейка поставок активных и пассивных импортных электронных компонентов (более 30 млн. наименований);
- Поставка сложных, дефицитных, либо снятых с производства позиций;
- Оперативные сроки поставки под заказ (от 5 рабочих дней);
- Экспресс доставка в любую точку России;
- Помощь Конструкторского Отдела и консультации квалифицированных инженеров;
- Техническая поддержка проекта, помощь в подборе аналогов, поставка прототипов;
- Поставка электронных компонентов под контролем ВП;
- Система менеджмента качества сертифицирована по Международному стандарту ISO 9001;
- При необходимости вся продукция военного и аэрокосмического назначения проходит испытания и сертификацию в лаборатории (по согласованию с заказчиком);
- Поставка специализированных компонентов военного и аэрокосмического уровня качества (Xilinx, Altera, Analog Devices, Intersil, Interpoint, Microsemi, Actel, Aeroflex, Peregrine, VPT, Syfer, Eurofarad, Texas Instruments, MS Kennedy, Miteq, Cobham, E2V, MA-COM, Hittite, Mini-Circuits, General Dynamics и др.);

Компания «Океан Электроники» является официальным дистрибьютором и эксклюзивным представителем в России одного из крупнейших производителей разъемов военного и аэрокосмического назначения «JONHON», а так же официальным дистрибьютором и эксклюзивным представителем в России производителя высокотехнологичных и надежных решений для передачи СВЧ сигналов «FORSTAR».



JONHON

«JONHON» (основан в 1970 г.)

Разъемы специального, военного и аэрокосмического назначения:

(Применяются в военной, авиационной, аэрокосмической, морской, железнодорожной, горно- и нефтедобывающей отраслях промышленности)

«FORSTAR» (основан в 1998 г.)

ВЧ соединители, коаксиальные кабели, кабельные сборки и микроволновые компоненты:

(Применяются в телекоммуникациях гражданского и специального назначения, в средствах связи, РЛС, а так же военной, авиационной и аэрокосмической отраслях промышленности).



Телефон: 8 (812) 309-75-97 (многоканальный)

Факс: 8 (812) 320-03-32

Электронная почта: ocean@oceanchips.ru

Web: <http://oceanchips.ru/>

Адрес: 198099, г. Санкт-Петербург, ул. Калинина, д. 2, корп. 4, лит. А