

LM2931, NCV2931 Series

100 mA, Adjustable Output, LDO Voltage Regulator with 60 V Load Dump Protection

The LM2931 series consists of positive fixed and adjustable output voltage regulators that are specifically designed to maintain proper regulation with an extremely low input-to-output voltage differential. These devices are capable of supplying output currents in excess of 100 mA and feature a low bias current of 0.4 mA at 10 mA output.

Designed primarily to survive in the harsh automotive environment, these devices will protect all external load circuitry from input fault conditions caused by reverse battery connection, two battery jump starts, and excessive line transients during load dump. This series also includes internal current limiting, thermal shutdown, and additionally, is able to withstand temporary power-up with mirror-image insertion.

Due to the low dropout voltage and bias current specifications, the LM2931 series is ideally suited for battery powered industrial and consumer equipment where an extension of useful battery life is desirable. The 'C' suffix adjustable output regulators feature an output inhibit pin which is extremely useful in microprocessor-based systems.

Features

- Input-to-Output Voltage Differential of $< 0.6\text{ V @ }100\text{ mA}$
- Output Current in Excess of 100 mA
- Low Bias Current
- 60 V Load Dump Protection
- -50 V Reverse Transient Protection
- Internal Current Limiting with Thermal Shutdown
- Temporary Mirror-Image Protection
- Ideally Suited for Battery Powered Equipment
- Economical 5-Lead TO-220 Package with Two Optional Leadforms
- Available in Surface Mount SOP-8, D²PAK and DPAK Packages
- High Accuracy ($\pm 2.5\%$) Reference (LM2931AC) Available
- Pb-Free Packages are Available
- NCV Prefix for Automotive and Other Applications Requiring Site and Control Changes

Applications

- Battery Powered Consumer Products
- Hand-held Instruments
- Camcorders and Cameras

SOIC-8
D SUFFIX
CASE 751

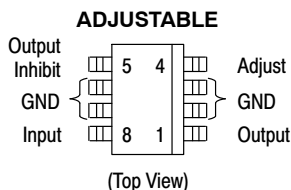
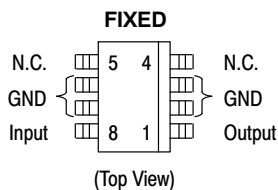

ON Semiconductor®

<http://onsemi.com>

FIXED OUTPUT VOLTAGE

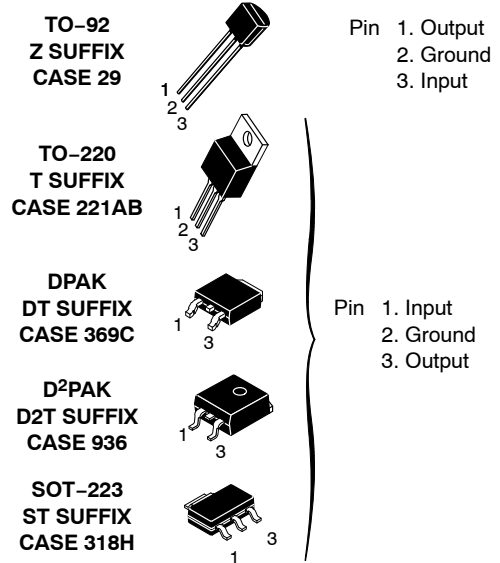

ADJUSTABLE OUTPUT VOLTAGE

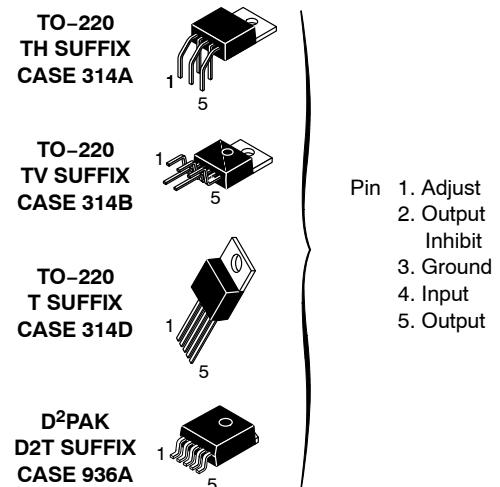

ORDERING INFORMATION

See detailed ordering and shipping information in the package dimensions section on page 12 of this data sheet.

DEVICE MARKING INFORMATION

See general marking and heatsink information in the device marking section on page 15 of this data sheet.

LM2931, NCV2931 Series

Representative Schematic Diagram

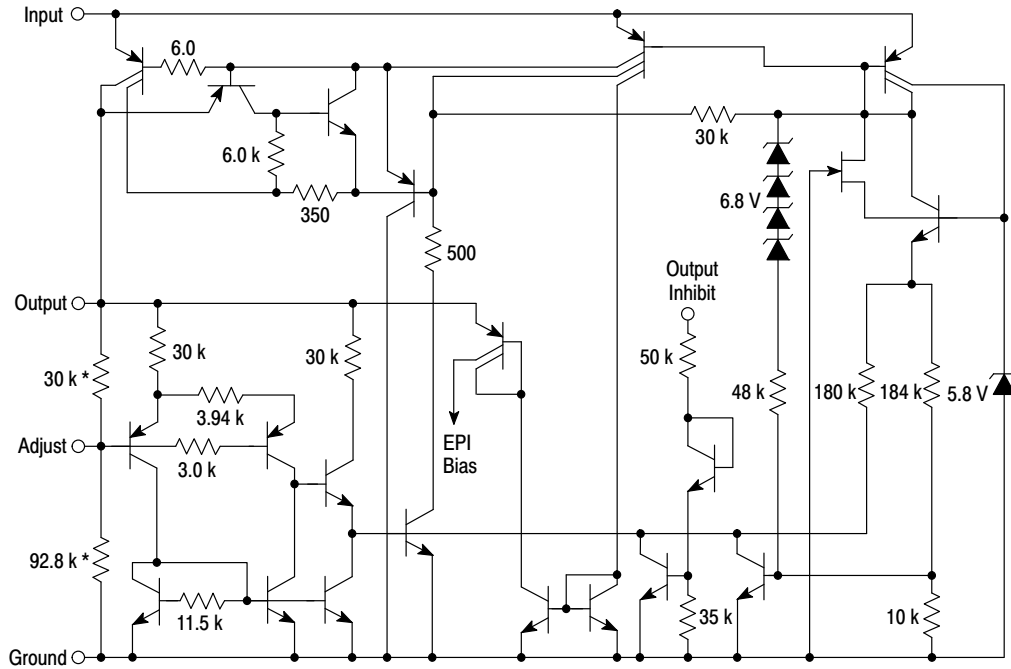

*Deleted on Adjustable Regulators

This device contains 26 active transistors.

LM2931, NCV2931 Series

MAXIMUM RATINGS

| Rating | Symbol | Value | Unit |
|---|-----------------|--------------------|--------------------|
| Input Voltage Continuous | V_I | 40 | Vdc |
| Transient Input Voltage ($\tau \leq 100$ ms) | $V_I(\tau)$ | 60 | Vpk |
| Transient Reverse Polarity Input Voltage 1.0% Duty Cycle, $\tau \leq 100$ ms | $-V_I(\tau)$ | -50 | Vpk |
| Electrostatic Discharge Sensitivity (ESD) | | | |
| Human Body Model (HBM) Class 2, JESD22 A114-C | - | 2000 | V |
| Machine Model (MM) Class A, JESD22 A115-A | - | 200 | V |
| Charged Device Model (CDM), JESD22 C101-C | - | 2000 | V |
| Power Dissipation | | | |
| Case 29 (TO-92 Type) | | | |
| $T_A = 25^\circ\text{C}$ | P_D | Internally Limited | W |
| Thermal Resistance, Junction-to-Ambient | $R_{\theta JA}$ | 178 | $^\circ\text{C/W}$ |
| Thermal Resistance, Junction-to-Case | $R_{\theta JC}$ | 83 | $^\circ\text{C/W}$ |
| Case 221A, 314A, 314B and 314D (TO-220 Type) | | | |
| $T_A = 25^\circ\text{C}$ | P_D | Internally Limited | W |
| Thermal Resistance, Junction-to-Ambient | $R_{\theta JA}$ | 65 | $^\circ\text{C/W}$ |
| Thermal Resistance, Junction-to-Case | $R_{\theta JC}$ | 5.0 | $^\circ\text{C/W}$ |
| Case 318H (SOT-223) | | | |
| $T_A = 25^\circ\text{C}$ | P_D | Internally Limited | W |
| Thermal Resistance, Junction-to-Ambient | $R_{\theta JA}$ | 242 | $^\circ\text{C/W}$ |
| Thermal Resistance, Junction-to-Case | $R_{\theta JC}$ | 21 | $^\circ\text{C/W}$ |
| Case 369A (DPAK) (Note 1) | | | |
| $T_A = 25^\circ\text{C}$ | P_D | Internally Limited | W |
| Thermal Resistance, Junction-to-Ambient | $R_{\theta JA}$ | 92 | $^\circ\text{C/W}$ |
| Thermal Resistance, Junction-to-Case | $R_{\theta JC}$ | 6.0 | $^\circ\text{C/W}$ |
| Case 751 (SOP-8) (Note 2) | | | |
| $T_A = 25^\circ\text{C}$ | P_D | Internally Limited | W |
| Thermal Resistance, Junction-to-Ambient | $R_{\theta JA}$ | 160 | $^\circ\text{C/W}$ |
| Thermal Resistance, Junction-to-Case | $R_{\theta JC}$ | 25 | $^\circ\text{C/W}$ |
| Case 936 and 936A (D ² PAK) (Note 3) | | | |
| $T_A = 25^\circ\text{C}$ | P_D | Internally Limited | W |
| Thermal Resistance, Junction-to-Ambient | $R_{\theta JA}$ | 70 | $^\circ\text{C/W}$ |
| Thermal Resistance, Junction-to-Case | $R_{\theta JC}$ | 5.0 | $^\circ\text{C/W}$ |
| Operating Ambient Temperature Range | T_A | -40 to +125 | $^\circ\text{C}$ |
| Operating Die Junction Temperature | T_J | +150 | $^\circ\text{C}$ |
| Storage Temperature Range | T_{stg} | -65 to +150 | $^\circ\text{C}$ |

Stresses exceeding Maximum Ratings may damage the device. Maximum Ratings are stress ratings only. Functional operation above the Recommended Operating Conditions is not implied. Extended exposure to stresses above the Recommended Operating Conditions may affect device reliability.

1. DPAK Junction-to-Ambient Thermal Resistance is for vertical mounting. Refer to Figure 25 for board mounted Thermal Resistance.
2. SOP-8 Junction-to-Ambient Thermal Resistance is for minimum recommended pad size. Refer to Figure 24 for Thermal Resistance variation versus pad size.
3. D²PAK Junction-to-Ambient Thermal Resistance is for vertical mounting. Refer to Figure 26 for board mounted Thermal Resistance.
4. NCV rated devices are subjected to and meet the AECQ-100 quality standards.

LM2931, NCV2931 Series

ELECTRICAL CHARACTERISTICS ($V_{in} = 14\text{ V}$, $I_O = 10\text{ mA}$, $C_O = 100\text{ }\mu\text{F}$, $C_{O(ESR)} = 0.3\text{ }\Omega$, $T_A = 25^\circ\text{C}$ [Note 5])

| Characteristic | Symbol | LM2931-5.0/NCV2931-5.0 | | | LM2931A-5.0/NCV2931A-5.0 | | | Unit |
|---|---------------------|------------------------|-------|------|--------------------------|-------|------|------------------|
| | | Min | Typ | Max | Min | Typ | Max | |
| FIXED OUTPUT | | | | | | | | |
| Output Voltage | V_O | | | | | | | V |
| $V_{in} = 14\text{ V}$, $I_O = 10\text{ mA}$, $T_A = 25^\circ\text{C}$ | | 4.75 | 5.0 | 5.25 | 4.81 | 5.0 | 5.19 | |
| $V_{in} = 6.0\text{ V to }26\text{ V}$, $I_O \leq 100\text{ mA}$, $T_A = -40^\circ\text{ to }+125^\circ\text{C}$ | | 4.50 | – | 5.50 | 4.75 | – | 5.25 | |
| Line Regulation | Reg_{line} | | | | | | | mV |
| $V_{in} = 9.0\text{ V to }16\text{ V}$ | | – | 2.0 | 10 | – | 2.0 | 10 | |
| $V_{in} = 6.0\text{ V to }26\text{ V}$ | | – | 4.0 | 30 | – | 4.0 | 30 | |
| Load Regulation ($I_O = 5.0\text{ mA to }100\text{ mA}$) | Reg_{load} | – | 14 | 50 | – | 14 | 50 | mV |
| Output Impedance | Z_O | | | | | | | $\text{m}\Omega$ |
| $I_O = 10\text{ mA}$, $\Delta I_O = 1.0\text{ mA}$, $f = 100\text{ Hz to }10\text{ kHz}$ | | – | 200 | – | – | 200 | – | |
| Bias Current | I_B | | | | | | | mA |
| $V_{in} = 14\text{ V}$, $I_O = 100\text{ mA}$, $T_A = 25^\circ\text{C}$ | | – | 5.8 | 30 | – | 5.8 | 30 | |
| $V_{in} = 6.0\text{ V to }26\text{ V}$, $I_O = 10\text{ mA}$, $T_A = -40^\circ\text{ to }+125^\circ\text{C}$ | | – | 0.4 | 1.0 | – | 0.4 | 1.0 | |
| Output Noise Voltage ($f = 10\text{ Hz to }100\text{ kHz}$) | V_n | – | 700 | – | – | 700 | – | μVrms |
| Long Term Stability | S | – | 20 | – | – | 20 | – | mV/kHR |
| Ripple Rejection ($f = 120\text{ Hz}$) | RR | 60 | 90 | – | 60 | 90 | – | dB |
| Dropout Voltage | $V_I - V_O$ | | | | | | | V |
| $I_O = 10\text{ mA}$ | | – | 0.015 | 0.2 | – | 0.015 | 0.2 | |
| $I_O = 100\text{ mA}$ | | – | 0.16 | 0.6 | – | 0.16 | 0.6 | |
| Over-Voltage Shutdown Threshold | $V_{th(OV)}$ | 26 | 29.5 | 40 | 26 | 29.5 | 40 | V |
| Output Voltage with Reverse Polarity Input ($V_{in} = -15\text{ V}$) | $-V_O$ | -0.3 | 0 | – | -0.3 | 0 | – | V |

5. Low duty cycle pulse techniques are used during test to maintain junction temperature as close to ambient as possible.
6. NCV devices are qualified for automotive use.

LM2931, NCV2931 Series

ELECTRICAL CHARACTERISTICS ($V_{in} = 14\text{ V}$, $I_O = 10\text{ mA}$, $C_O = 100\text{ }\mu\text{F}$, $C_{O(ESR)} = 0.3\text{ }\Omega$, $T_A = 25^\circ\text{C}$ [Note 7])

| Characteristic | Symbol | LM2931C/NCV2931C | | | LM2931AC/NCV2931AC | | | Unit |
|--|--------------------|------------------------|------------------------|------------------------|------------------------|------------------------|------------------------|------------------------------|
| | | Min | Typ | Max | Min | Typ | Max | |
| ADJUSTABLE OUTPUT | | | | | | | | |
| Reference Voltage (Note 8, Figure 18) $I_O = 10\text{ mA}$, $T_A = 25^\circ\text{C}$ $I_O \leq 100\text{ mA}$, $T_A = -40\text{ to }+125^\circ\text{C}$ | V_{ref} | 1.14 1.08 | 1.20 – | 1.26 1.32 | 1.17 1.15 | 1.20 – | 1.23 1.25 | V |
| Output Voltage Range | $V_O\text{ range}$ | 3.0 to 24 | 2.7 to 29.5 | – | 3.0 to 24 | 2.7 to 29.5 | – | V |
| Line Regulation ($V_{in} = V_O + 0.6\text{ V to }26\text{ V}$) | Reg_{line} | – | 0.2 | 1.5 | – | 0.2 | 1.5 | mV/V |
| Load Regulation ($I_O = 5.0\text{ mA to }100\text{ mA}$) | Reg_{load} | – | 0.3 | 1.0 | – | 0.3 | 1.0 | %/V |
| Output Impedance $I_O = 10\text{ mA}$, $\Delta I_O = 1.0\text{ mA}$, $f = 10\text{ Hz to }10\text{ kHz}$ | Z_O | – | 40 | – | – | 40 | – | $\text{m}\Omega/\text{V}$ |
| Bias Current $I_O = 100\text{ mA}$ $I_O = 10\text{ mA}$ Output Inhibited ($V_{th(OI)} = 2.5\text{ V}$) | I_B | – – – | 6.0 0.4 0.2 | – 1.0 1.0 | – – – | 6.0 0.4 0.2 | – 1.0 1.0 | mA |
| Adjustment Pin Current | I_{Adj} | – | 0.2 | – | – | 0.2 | – | μA |
| Output Noise Voltage ($f = 10\text{ Hz to }100\text{ kHz}$) | V_n | – | 140 | – | – | 140 | – | $\mu\text{V}_{rms}/\text{V}$ |
| Long-Term Stability | S | – | 0.4 | – | – | 0.4 | – | %/kHR |
| Ripple Rejection ($f = 120\text{ Hz}$) | RR | 0.10 | 0.003 | – | 0.10 | 0.003 | – | %/V |
| Dropout Voltage $I_O = 10\text{ mA}$ $I_O = 100\text{ mA}$ | $V_I - V_O$ | – – | 0.015 0.16 | 0.2 0.6 | – – | 0.015 0.16 | 0.2 0.6 | V |
| Over-Voltage Shutdown Threshold | $V_{th(OV)}$ | 26 | 29.5 | 40 | 26 | 29.5 | 40 | V |
| Output Voltage with Reverse Polarity Input ($V_{in} = -15\text{ V}$) | $-V_O$ | -0.3 | 0 | – | -0.3 | 0 | – | V |
| Output Inhibit Threshold Voltages Output "On": $T_A = 25^\circ\text{C}$ $T_A = -40^\circ\text{ to }+125^\circ\text{C}$ Output "Off": $T_A = 25^\circ\text{C}$ $T_A = -40^\circ\text{ to }+125^\circ\text{C}$ | $V_{th(OI)}$ | – – 2.50 3.25 | 2.15 – 2.26 – | 1.90 1.20 – – | – – 2.50 3.25 | 2.15 – 2.26 – | 1.90 1.20 – – | V |
| Output Inhibit Threshold Current ($V_{th(OI)} = 2.5\text{ V}$) | $I_{th(OI)}$ | – | 30 | 50 | – | 30 | 50 | μA |

7. Low duty cycle pulse techniques are used during test to maintain junction temperature as close to ambient as possible.

8. The reference voltage on the adjustable device is measured from the output to the adjust pin across R_1 .

LM2931, NCV2931 Series

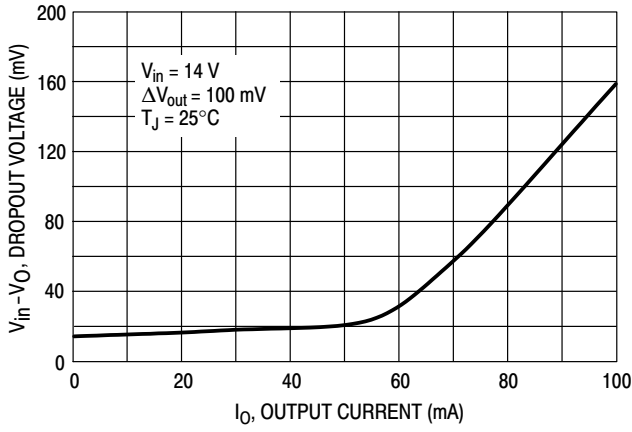

Figure 1. Dropout Voltage versus Output Current

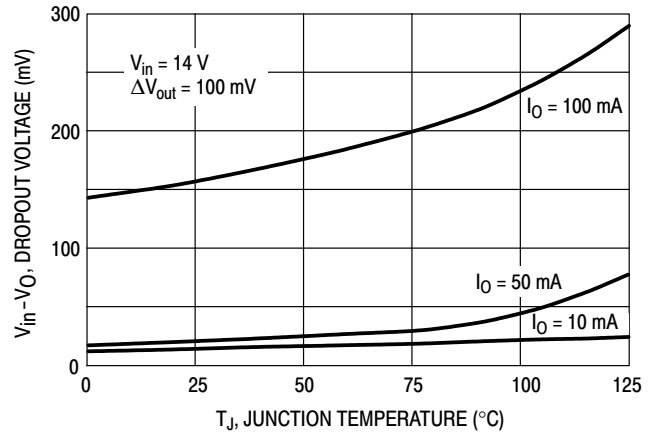

Figure 2. Dropout Voltage versus Junction Temperature

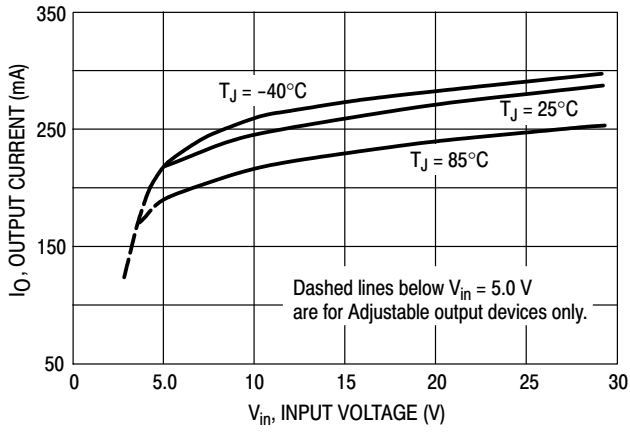

Figure 3. Peak Output Current versus Input Voltage

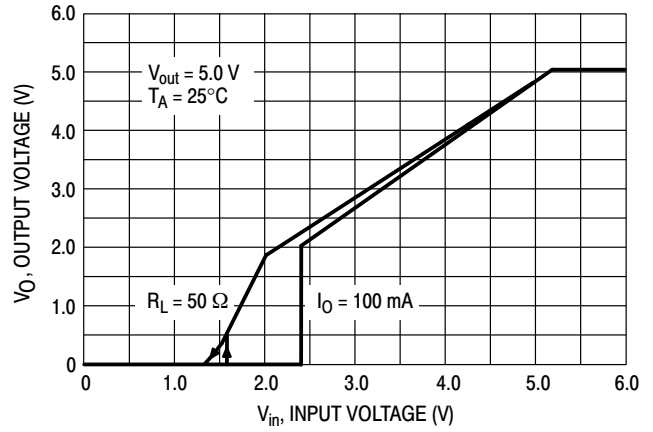

Figure 4. Output Voltage versus Input Voltage

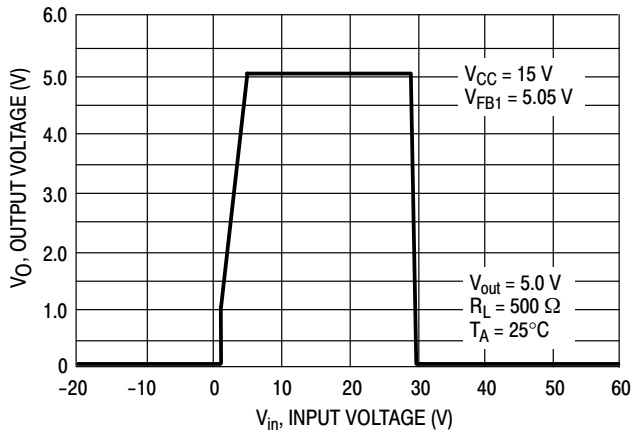

Figure 5. Output Voltage versus Input Voltage

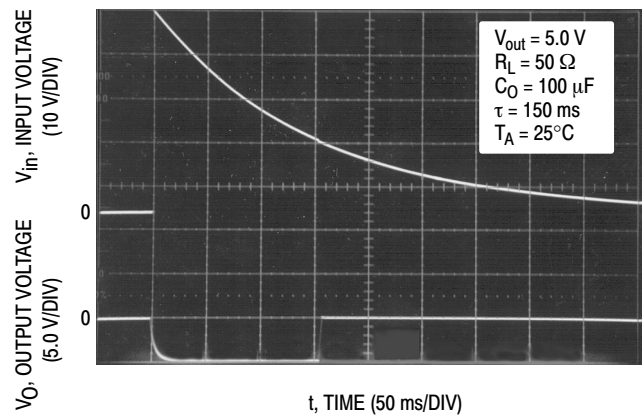

Figure 6. Load Dump Characteristics

LM2931, NCV2931 Series

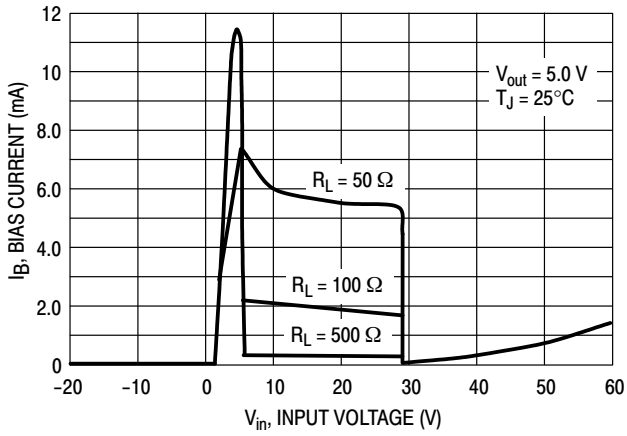

Figure 7. Bias Current versus Input Voltage

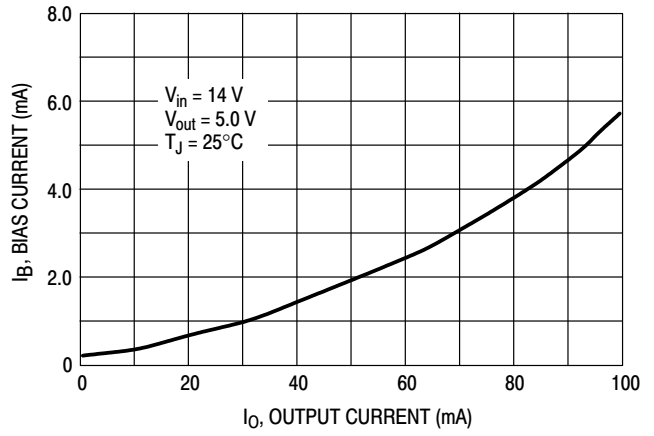

Figure 8. Bias Current versus Output Current

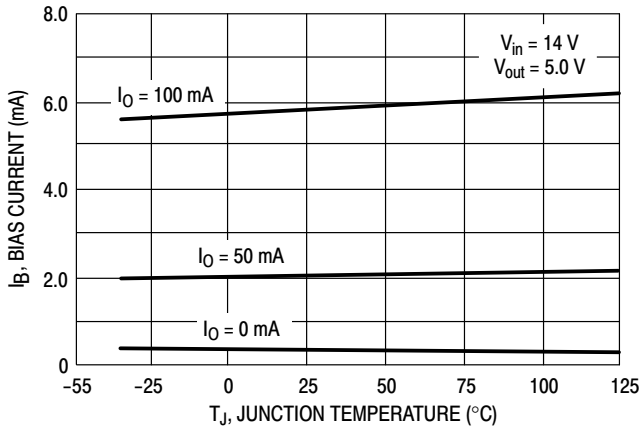

Figure 9. Bias Current versus Junction Temperature

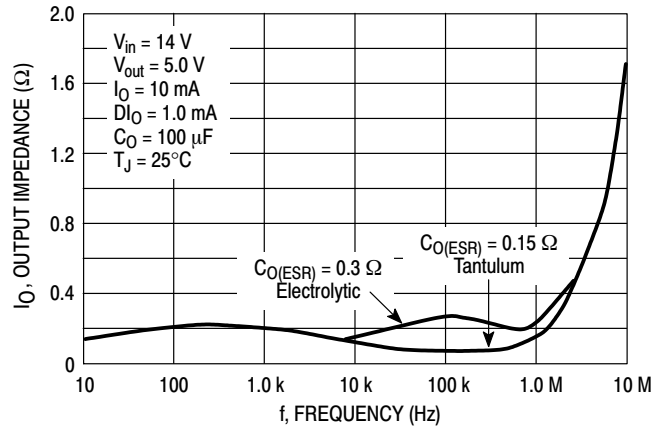

Figure 10. Output Impedance versus Frequency

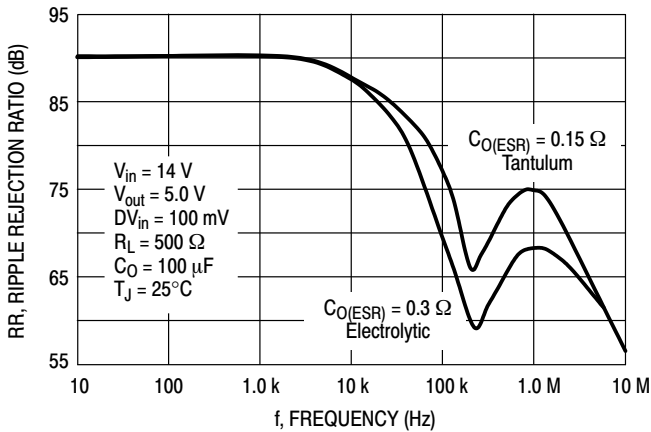

Figure 11. Ripple Rejection versus Frequency

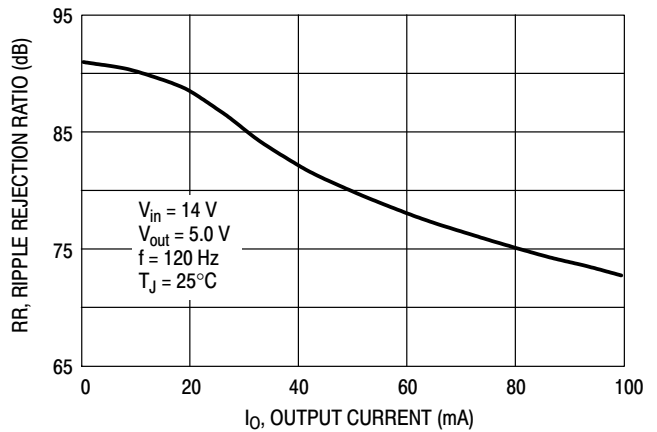

Figure 12. Ripple Rejection versus Output Current

LM2931, NCV2931 Series

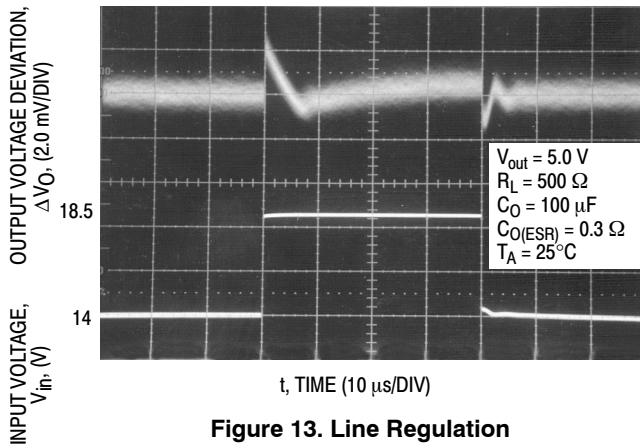

Figure 13. Line Regulation

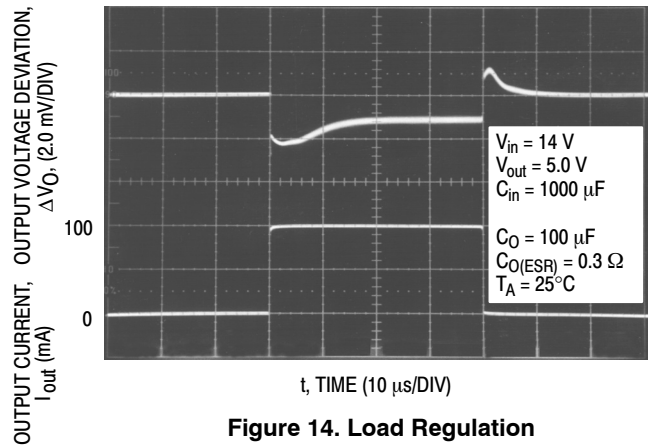

Figure 14. Load Regulation

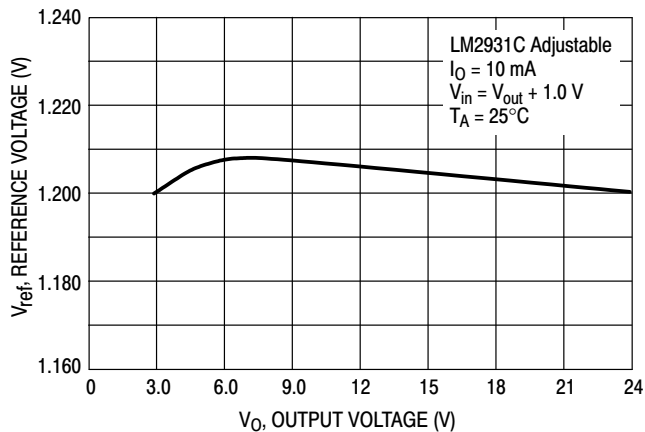

Figure 15. Reference Voltage versus Output Voltage

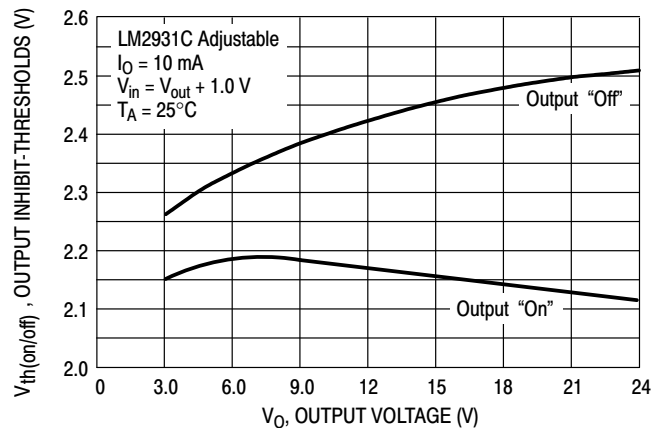

Figure 16. Output Inhibit-Thresholds versus Output Voltage

APPLICATIONS INFORMATION

The LM2931 series regulators are designed with many protection features making them essentially blow-out proof. These features include internal current limiting, thermal shutdown, overvoltage and reverse polarity input protection, and the capability to withstand temporary power-up with mirror-image insertion. Typical application circuits for the fixed and adjustable output device are shown in Figures 17 and 18.

The input bypass capacitor C_{in} is recommended if the regulator is located an appreciable distance ($\geq 4''$) from the supply input filter. This will reduce the circuit's sensitivity to the input line impedance at high frequencies.

This regulator series is not internally compensated and thus requires an external output capacitor for stability. The capacitance value required is dependent upon the load current, output voltage for the adjustable regulator, and the type of capacitor selected. The least stable condition is encountered at maximum load current and minimum output voltage. Figure 22 shows that for operation in the "Stable" region, under the conditions specified, the magnitude of the output capacitor impedance $|Z_O|$ must not exceed 0.4Ω . This

limit must be observed over the entire operating temperature range of the regulator circuit.

With economical electrolytic capacitors, cold temperature operation can pose a serious stability problem. As the electrolyte freezes, around -30°C , the capacitance will decrease and the equivalent series resistance (ESR) will increase drastically, causing the circuit to oscillate. Quality electrolytic capacitors with extended temperature ranges of -40° to $+85^\circ\text{C}$ and -55° to $+105^\circ\text{C}$ are readily available. Solid tantalum capacitors may be a better choice if small size is a requirement, however, the maximum $|Z_O|$ limit over temperature must be observed.

Note that in the stable region, the output noise voltage is linearly proportional to $|Z_O|$. In effect, C_O dictates the high frequency roll-off point of the circuit. Operation in the area titled "Marginally Stable" will cause the output of the regulator to exhibit random bursts of oscillation that decay in an under-damped fashion. Continuous oscillation occurs when operating in the area titled "Unstable". It is suggested that oven testing of the entire circuit be performed with maximum load, minimum input voltage, and minimum ambient temperature.

LM2931, NCV2931 Series

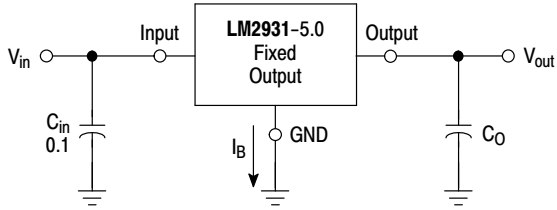
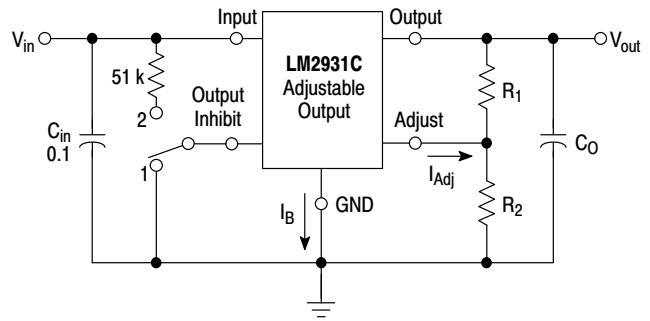

Figure 17. Fixed Output Regulator



Switch Position 1 = Output "On", 2 = Output "Off"

$$V_{out} = V_{ref} \left(1 + \frac{R_2}{R_1} \right) + I_{Adj} R_2 \quad 22.5 \text{ k} \geq \frac{R_1 R_2}{R_1 + R_2}$$

Figure 18. Adjustable Output Regulator

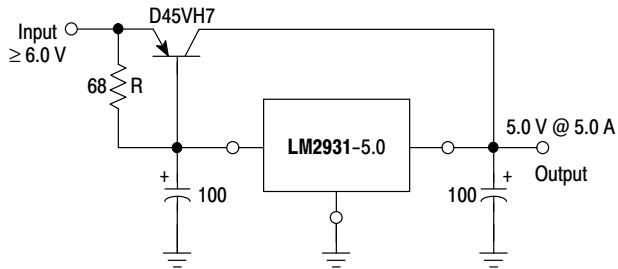

The LM2931 series can be current boosted with a PNP transistor. The D45VH7, on a heatsink, will provide an output current of 5.0 A with an input to output voltage differential of approximately 1.0 V. Resistor R in conjunction with the V_{BE} of the PNP determines when the pass transistor begins conducting. This circuit is not short circuit proof.

Figure 19. (5.0 A) Low Differential Voltage Regulator

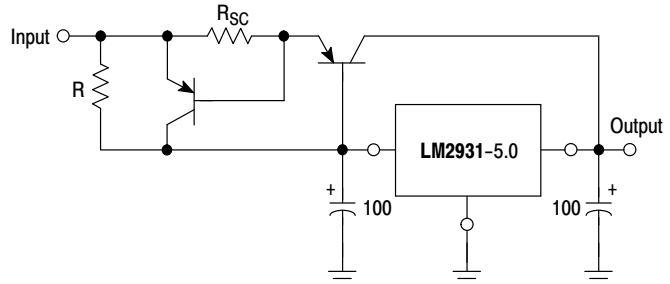

The circuit of Figure 19 can be modified to provide supply protection against short circuits by adding the current sense resistor R_{SC} and an additional PNP transistor. The current sensing PNP must be capable of handling the short circuit current of the LM2931. Safe operating area of both transistors must be considered under worst case conditions.

Figure 20. Current Boost Regulator with Short Circuit Projection

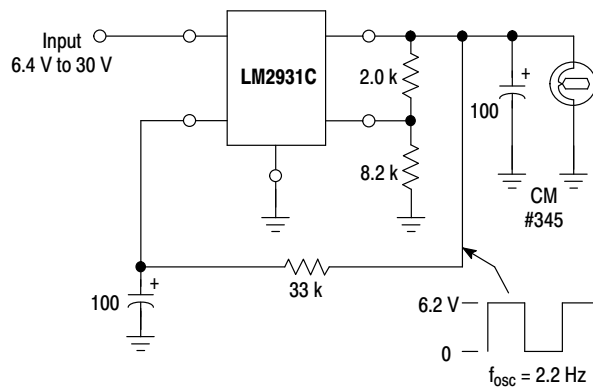

Figure 21. Constant Intensity Lamp Flasher

LM2931, NCV2931 Series

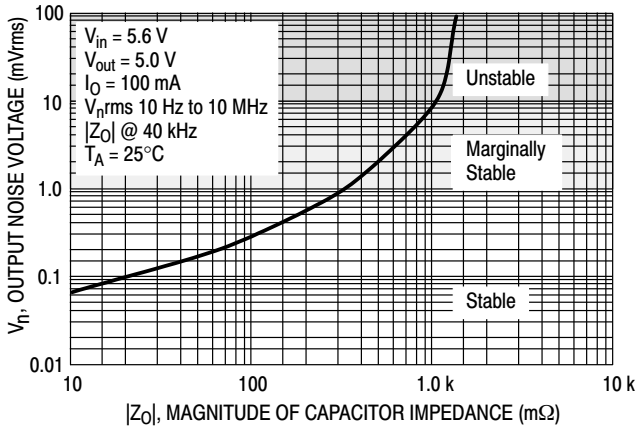

Figure 22. Output Noise Voltage vs. Output Capacitor Impedance

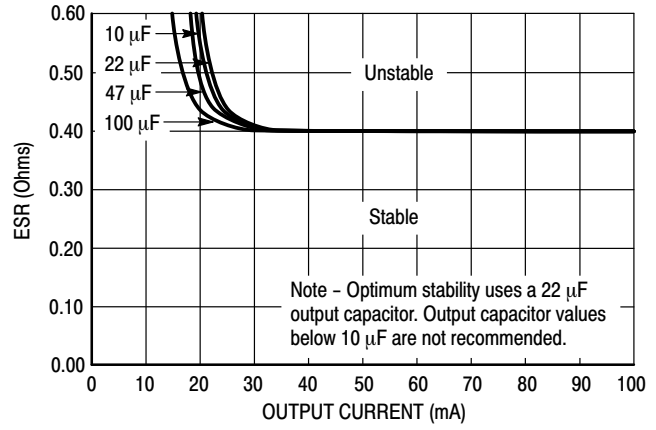

Figure 23. Output Capacitor ESR Stability vs. Output Load Current

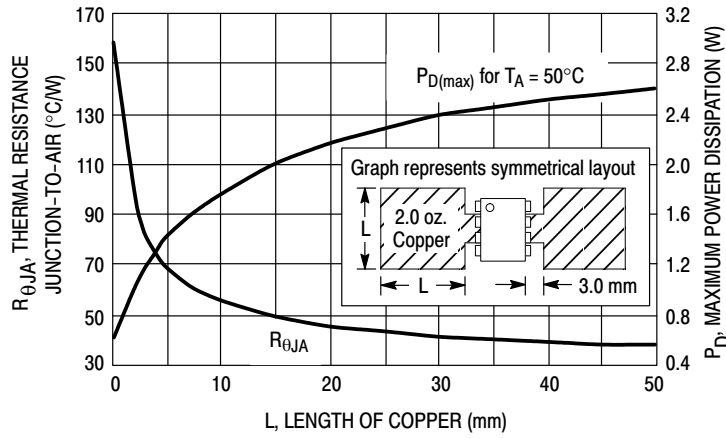

Figure 24. SOP-8 Thermal Resistance and Maximum Power Dissipation versus P.C.B. Copper Length

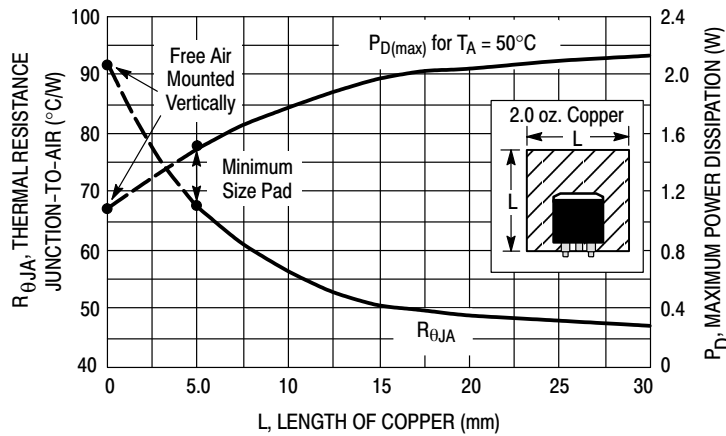

Figure 25. DPAK Thermal Resistance and Maximum Power Dissipation versus P.C.B. Copper Length

LM2931, NCV2931 Series

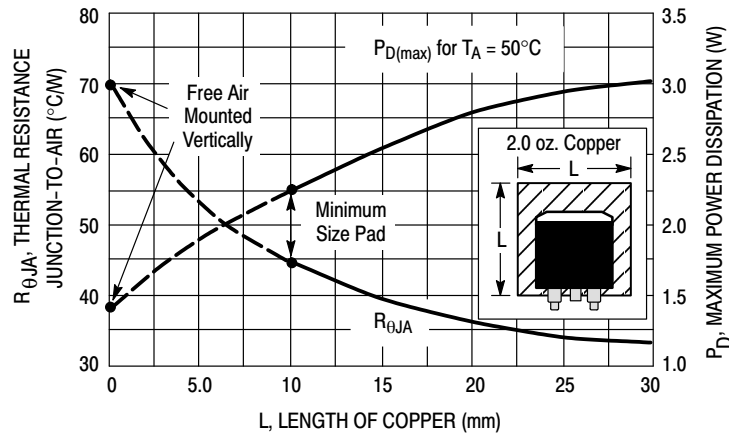

Figure 26. 3-Pin and 5-Pin D²PAK Thermal Resistance and Maximum Power Dissipation versus P.C.B. Copper Length

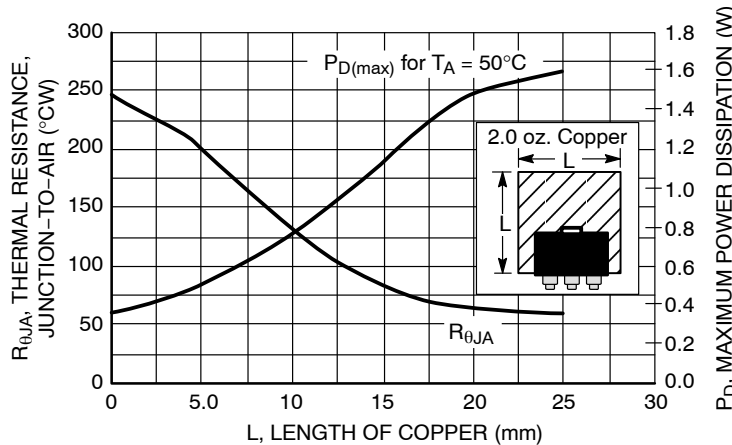

Figure 27. SOT-223 Thermal Resistance and Maximum Power Dissipation vs. P.C.B. Copper Length

DEFINITIONS

Dropout Voltage – The input/output voltage differential at which the regulator output no longer maintains regulation against further reductions in input voltage. Measured when the output decreases 100 mV from nominal value at 14 V input, dropout voltage is affected by junction temperature and load current.

Line Regulation – The change in output voltage for a change in the input voltage. The measurement is made under conditions of low dissipation or by using pulse techniques such that the average chip temperature is not significantly affected.

Load Regulation – The change in output voltage for a change in load current at constant chip temperature.

Maximum Power Dissipation – The maximum total device dissipation for which the regulator will operate within specifications.

Bias Current – That part of the input current that is not delivered to the load.

Output Noise Voltage – The rms AC voltage at the output, with constant load and no input ripple, measured over a specified frequency range.

Long-Term Stability – Output voltage stability under accelerated life test conditions with the maximum rated voltage listed in the devices electrical characteristics and maximum power dissipation.

LM2931, NCV2931 Series

ORDERING INFORMATION

| Device | Output | | Package | Shipping [†] |
|------------------|---------|-----------|---------------------------------|-----------------------|
| | Voltage | Tolerance | | |
| LM2931AD-5.0 | 5.0 V | ±3.8% | SOIC-8 | 98 Units / Rail |
| LM2931AD-5.0G | 5.0 V | ±3.8% | SOIC-8 (Pb-Free) | 98 Units / Rail |
| LM2931AD-5.0R2 | 5.0 V | ±3.8% | SOIC-8 | 2500 / Tape & Reel |
| LM2931AD-5.0R2G | 5.0 V | ±3.8% | SOIC-8 (Pb-Free) | 2500 / Tape & Reel |
| LM2931ADT-5.0 | 5.0 V | ±3.8% | DPAK | 75 Units / Rail |
| LM2931ADT-5.0G | 5.0 V | ±3.8% | DPAK (Pb-Free) | 75 Units / Rail |
| LM2931ADT-5.0RK | 5.0 V | ±3.8% | DPAK | 2500 / VacPk Reel |
| LM2931ADT-5.0RKG | 5.0 V | ±3.8% | DPAK (Pb-Free) | 2500 / VacPk Reel |
| LM2931AD2T-5.0 | 5.0 V | ±3.8% | D ² PAK | 50 Units / Rail |
| LM2931AD2T-5.0G | 5.0 V | ±3.8% | D ² PAK (Pb-Free) | 50 Units / Rail |
| LM2931AD2T-5.0R4 | 5.0 V | ±3.8% | D ² PAK | 800 / VacPk Reel |
| LM2931AD2T-5R4G | 5.0 V | ±3.8% | D ² PAK (Pb-Free) | 800 / VacPk Reel |
| LM2931AT-5.0 | 5.0 V | ±3.8% | TO-220 | 50 Units / Rail |
| LM2931AT-5.0G | 5.0 V | ±3.8% | TO-220 (Pb-Free) | 50 Units / Rail |
| LM2931AZ-5.0 | 5.0 V | ±3.8% | TO-92 | 2000 / Inner Bag |
| LM2931AZ-5.0G | 5.0 V | ±3.8% | TO-92 (Pb-Free) | 2000 / Inner Bag |
| LM2931AZ-5.0RA | 5.0 V | ±3.8% | TO-92 | 2000 / Tape & Reel |
| LM2931AZ-5.0RAG | 5.0 V | ±3.8% | TO-92 (Pb-Free) | 2000 / Tape & Reel |
| LM2931AZ-5.0RP | 5.0 V | ±3.8% | TO-92 | 2000 / Ammo Pack |
| LM2931AZ-5.0RPG | 5.0 V | ±3.8% | TO-92 (Pb-Free) | 2000 / Ammo Pack |
| LM2931D-5.0 | 5.0 V | ±5.0% | SOIC-8 | 98 Units / Rail |
| LM2931D-5.0G | 5.0 V | ±5.0% | SOIC-8 (Pb-Free) | 98 Units / Rail |
| LM2931D-5.0R2 | 5.0 V | ±5.0% | SOIC-8 | 2500 / Tape & Reel |
| LM2931D-5.0R2G | 5.0 V | ±5.0% | SOIC-8 (Pb-Free) | 2500 / Tape & Reel |
| LM2931D2T-5.0 | 5.0 V | ±5.0% | D ² PAK | 50 Units / Rail |
| LM2931D2T-5.0G | 5.0 V | ±5.0% | D ² PAK (Pb-Free) | 50 Units / Rail |
| LM2931D2T-5.0R4 | 5.0 V | ±5.0% | D ² PAK | 800 / VacPk Reel |
| LM2931D2T-5.0R4G | 5.0 V | ±5.0% | D ² PAK (Pb-Free) | 800 / VacPk Reel |

[†]For information on tape and reel specifications, including part orientation and tape sizes, please refer to our Tape and Reel Packaging Specifications Brochure, BRD8011/D.

*NCV2931: T_{low} = -40°C, T_{high} = +125°C. Guaranteed by design. NCV prefix is for automotive and other applications requiring site and change control.

LM2931, NCV2931 Series

ORDERING INFORMATION

| Device | Output | | Package | Shipping [†] |
|----------------|------------|-----------|---------------------------------|-----------------------|
| | Voltage | Tolerance | | |
| LM2931DT-5.0 | 5.0 V | ± 5.0% | DPAK | 75 Units / Rail |
| LM2931DT-5.0G | 5.0 V | ± 5.0% | DPAK (Pb-Free) | 75 Units / Rail |
| LM2931T-5.0 | 5.0 V | ± 5.0% | TO-220 | 50 Units / Rail |
| LM2931T-5.0G | 5.0 V | ± 5.0% | TO-220 (Pb-Free) | 50 Units / Rail |
| LM2931Z-5.0 | 5.0 V | ± 5.0% | TO-92 | 2000 / Inner Bag |
| LM2931Z-5.0G | 5.0 V | ± 5.0% | TO-92 (Pb-Free) | 2000 / Inner Bag |
| LM2931Z-5.0RA | 5.0 V | ± 5.0% | TO-92 | 2000 / Tape & Reel |
| LM2931Z-5.0RAG | 5.0 V | ± 5.0% | TO-92 (Pb-Free) | 2000 / Tape & Reel |
| LM2931Z-5.0RP | 5.0 V | ± 5.0% | TO-92 | 2000 / Ammo Pack |
| LM2931Z-5.0RPG | 5.0 V | ± 5.0% | TO-92 (Pb-Free) | 2000 / Ammo Pack |
| LM2931CD | Adjustable | ± 5.0% | SOIC-8 | 98 Units / Rail |
| LM2931CDG | Adjustable | ± 5.0% | SOIC-8 (Pb-Free) | 98 Units / Rail |
| LM2931CDR2 | Adjustable | ± 5.0% | SOIC-8 | 2500 / Tape & Reel |
| LM2931CDR2G | Adjustable | ± 5.0% | SOIC-8 (Pb-Free) | 2500 / Tape & Reel |
| LM2931CD2T | Adjustable | ± 5.0% | D ² PAK | 50 Units / Rail |
| LM2931CD2TG | Adjustable | ± 5.0% | D ² PAK (Pb-Free) | 50 Units / Rail |
| LM2931CD2TR4 | Adjustable | ± 5.0% | D ² PAK | 800 / VacPk Reel |
| LM2931CD2TR4G | Adjustable | ± 5.0% | D ² PAK (Pb-Free) | 800 / VacPk Reel |
| LM2931CT | Adjustable | ± 5.0% | TO-220 | 50 Units / Rail |
| LM2931CTG | Adjustable | ± 5.0% | TO-220 (Pb-Free) | 50 Units / Rail |
| LM2931ACD | Adjustable | ± 2.0% | SOIC-8 | 98 Units / Rail |
| LM2931ACDG | Adjustable | ± 2.0% | SOIC-8 (Pb-Free) | 98 Units / Rail |
| LM2931ACDR2 | Adjustable | ± 2.0% | SOIC-8 | 2500 / Tape & Reel |
| LM2931ACDR2G | Adjustable | ± 2.0% | SOIC-8 (Pb-Free) | 2500 / Tape & Reel |
| LM2931ACD2TR4 | Adjustable | ± 2.0% | D ² PAK | 800 / VacPk Reel |
| LM2931ACD2TR4G | Adjustable | ± 2.0% | D ² PAK (Pb-Free) | 800 / VacPk Reel |
| LM2931ACTV | Adjustable | ± 2.0% | TO-220 | 50 Units / Rail |
| LM2931ACTVG | Adjustable | ± 2.0% | TO-220 (Pb-Free) | 50 Units / Rail |

[†]For information on tape and reel specifications, including part orientation and tape sizes, please refer to our Tape and Reel Packaging Specifications Brochure, BRD8011/D.

*NCV2931: T_{low} = -40°C, T_{high} = +125°C. Guaranteed by design. NCV prefix is for automotive and other applications requiring site and change control.

LM2931, NCV2931 Series

ORDERING INFORMATION

| Device | Output | | Package | Shipping [†] |
|--------------------|------------|-----------|---------------------------------|-----------------------|
| | Voltage | Tolerance | | |
| NCV2931ACDR2* | Adjustable | ± 2.5% | SOIC-8 | 2500 / Tape & Reel |
| NCV2931ACDR2G* | Adjustable | ± 2.5% | SOIC-8 (Pb-Free) | 2500 / Tape & Reel |
| NCV2931AD-5.0R2* | 5.0 V | ± 3.8% | SOIC-8 | 2500 / Tape & Reel |
| NCV2931AD-5.0R2G* | 5.0 V | ± 3.8% | SOIC-8 (Pb-Free) | 2500 / Tape & Reel |
| NCV2931AST-5.0T3* | 5.0 V | ± 3.8% | SOT-223 | 4000 / Tape & Reel |
| NCV2931AST-5.0T3G* | 5.0 V | ± 3.8% | SOT-223 (Pb-Free) | 4000 / Tape & Reel |
| NCV2931AZ-5.0G* | 5.0 V | ± 3.8% | TO-92 (Pb-Free) | 2000 / Inner Bag |
| NCV2931AZ-5.0RAG* | 5.0 V | ± 3.8% | TO-92 (Pb-Free) | 2000 / Tape & Reel |
| NCV2931CDR2* | Adjustable | ± 5.0% | SOIC-8 | 2500 / Tape & Reel |
| NCV2931CDR2G* | Adjustable | ± 5.0% | SOIC-8 (Pb-Free) | 2500 / Tape & Reel |
| NCV2931D-5.0R2* | 5.0 V | ± 5.0% | SOIC-8 | 2500 / Tape & Reel |
| NCV2931D-5.0R2G* | 5.0 V | ± 5.0% | SOIC-8 (Pb-Free) | 2500 / Tape & Reel |
| NCV2931ADT-5.0RK* | 5.0 V | ± 3.8% | DPAK | 2500 / Tape & Reel |
| NCV2931ADT5.0RKG* | 5.0 V | ± 3.8% | DPAK (Pb-Free) | 2500 / Tape & Reel |
| NCV2931DT-5.0RK* | 5.0 V | ± 5.0% | DPAK | 2500 / Tape & Reel |
| NCV2931DT-5.0RKG* | 5.0 V | ± 5.0% | DPAK (Pb-Free) | 2500 / Tape & Reel |
| NCV2931ACD2TR4G* | Adjustable | ± 2.5% | D ² PAK (Pb-Free) | 800 / VacPk Reel |
| NCV2931D2T-5.0R4* | 5.0 V | ± 5.0% | D ² PAK | 800 / VacPk Reel |
| NCV2931D2T5.0R4G* | 5.0 V | ± 5.0% | D ² PAK (Pb-Free) | 800 / VacPk Reel |

†For information on tape and reel specifications, including part orientation and tape sizes, please refer to our Tape and Reel Packaging Specifications Brochure, BRD8011/D.

*NCV2931: T_{low} = -40°C, T_{high} = +125°C. Guaranteed by design. NCV prefix is for automotive and other applications requiring site and change control.

LM2931, NCV2931 Series

MARKING DIAGRAMS

**DKPAK
DT SUFFIX
CASE 369A**



**DKPAK
DT SUFFIX
CASE 369A**

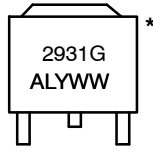

**D2PAK
D2T SUFFIX
CASE 936**



**D2PAK
D2T SUFFIX
CASE 936**



**D2PAK
D2T SUFFIX
CASE 936**

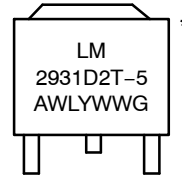

Heatsink surface (shown as terminal 4 in case outline drawing) is connected to Pin 2.

**TO-220
T SUFFIX
CASE 221A**

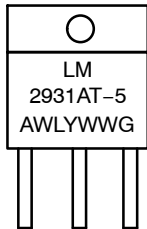

**TO-220
T SUFFIX
CASE 221A**

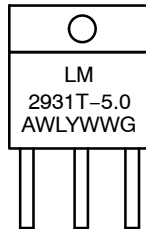

**TO-220
T SUFFIX
CASE 314D**



**D2PAK
D2T SUFFIX
CASE 936A**



**D2PAK
D2T SUFFIX
CASE 936A**

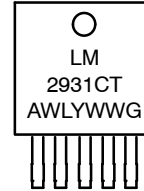

Heatsink surface connected to Pin 2.

Heatsink surface connected to Pin 3.

Heatsink surface (shown as terminal 6 in case outline drawing) is connected to Pin 3.

**SOIC-8
D SUFFIX
CASE 751**

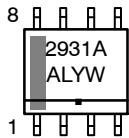

**SOIC-8
D SUFFIX
CASE 751**

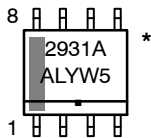

**SOIC-8
D SUFFIX
CASE 751**

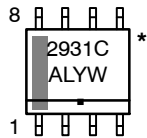

**SOIC-8
D SUFFIX
CASE 751**

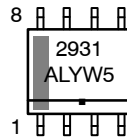

**TO-92
Z SUFFIX
CASE 029**

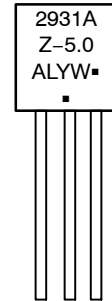

**TO-92
Z SUFFIX
CASE 029**

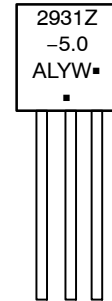

**SOT-223
ST SUFFIX
CASE 318H**

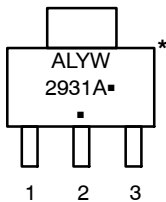

A = Assembly Location
 WL, L = Wafer Lot
 YY, Y = Year
 WW, W = Work Week
 G or ■ = Pb-Free Device

*This marking diagram also applies to NCV2931.

LM2931, NCV2931 Series

PACKAGE DIMENSIONS

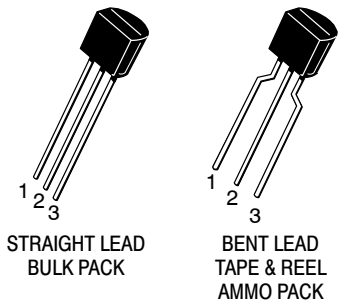

TO-92 (TO-226)
CASE 29-11
ISSUE AM

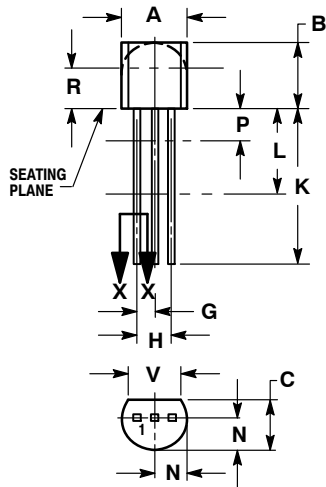

STRAIGHT LEAD
BULK PACK

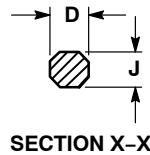

SECTION X-X

NOTES:

1. DIMENSIONING AND TOLERANCING PER ANSI Y14.5M, 1982.
2. CONTROLLING DIMENSION: INCH.
3. CONTOUR OF PACKAGE BEYOND DIMENSION R IS UNCONTROLLED.
4. LEAD DIMENSION IS UNCONTROLLED IN P AND BEYOND DIMENSION K MINIMUM.

| DIM | INCHES | | MILLIMETERS | |
|-----|--------|-------|-------------|-------|
| | MIN | MAX | MIN | MAX |
| A | 0.175 | 0.205 | 4.45 | 5.20 |
| B | 0.170 | 0.210 | 4.32 | 5.33 |
| C | 0.125 | 0.165 | 3.18 | 4.19 |
| D | 0.016 | 0.021 | 0.407 | 0.533 |
| G | 0.045 | 0.055 | 1.15 | 1.39 |
| H | 0.095 | 0.105 | 2.42 | 2.66 |
| J | 0.015 | 0.020 | 0.39 | 0.50 |
| K | 0.500 | --- | 12.70 | --- |
| L | 0.250 | --- | 6.35 | --- |
| N | 0.080 | 0.105 | 2.04 | 2.66 |
| P | --- | 0.100 | --- | 2.54 |
| R | 0.115 | --- | 2.93 | --- |
| V | 0.135 | --- | 3.43 | --- |

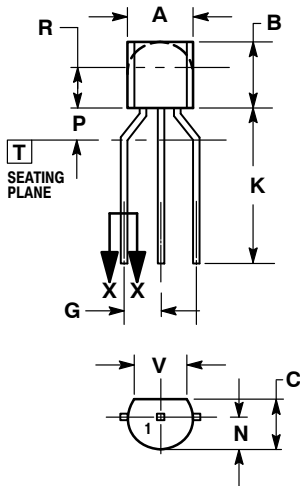

BENT LEAD
TAPE & REEL
AMMO PACK

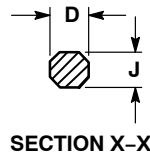

SECTION X-X

NOTES:

1. DIMENSIONING AND TOLERANCING PER ASME Y14.5M, 1994.
2. CONTROLLING DIMENSION: MILLIMETERS.
3. CONTOUR OF PACKAGE BEYOND DIMENSION R IS UNCONTROLLED.
4. LEAD DIMENSION IS UNCONTROLLED IN P AND BEYOND DIMENSION K MINIMUM.

| DIM | MILLIMETERS | |
|-----|-------------|------|
| | MIN | MAX |
| A | 4.45 | 5.20 |
| B | 4.32 | 5.33 |
| C | 3.18 | 4.19 |
| D | 0.40 | 0.54 |
| G | 2.40 | 2.80 |
| J | 0.39 | 0.50 |
| K | 12.70 | --- |
| N | 2.04 | 2.66 |
| P | 1.50 | 4.00 |
| R | 2.93 | --- |
| V | 3.43 | --- |

LM2931, NCV2931 Series

PACKAGE DIMENSIONS

TO-220, SINGLE GAUGE CASE 221AB-01 ISSUE A

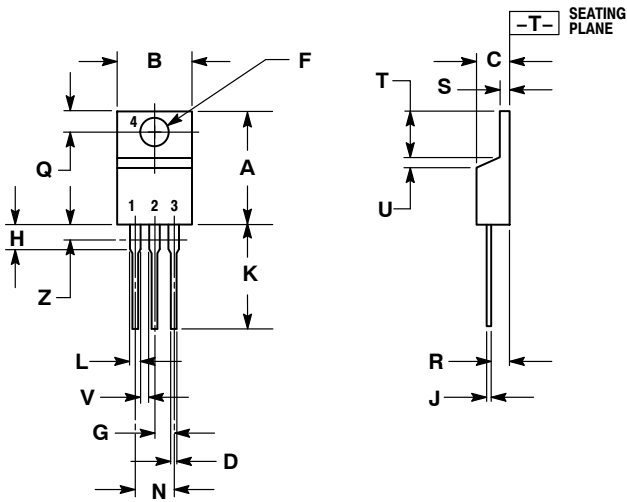

- NOTES:
1. DIMENSIONING AND TOLERANCING PER ANSI Y14.5M, 1982.
 2. CONTROLLING DIMENSION: INCHES.
 3. DIMENSION Z DEFINES A ZONE WHERE ALL BODY AND LEAD IRREGULARITIES ARE ALLOWED.
 4. PRODUCT SHIPPED PRIOR TO 2008 HAD DIMENSIONS
S = 0.045 - 0.055 INCHES (1.143 - 1.397 MM)

| DIM | INCHES | | MILLIMETERS | |
|-----|--------|-------|-------------|-------|
| | MIN | MAX | MIN | MAX |
| A | 0.570 | 0.620 | 14.48 | 15.75 |
| B | 0.380 | 0.405 | 9.66 | 10.28 |
| C | 0.160 | 0.190 | 4.07 | 4.82 |
| D | 0.025 | 0.035 | 0.64 | 0.88 |
| F | 0.142 | 0.147 | 3.61 | 3.73 |
| G | 0.095 | 0.105 | 2.42 | 2.66 |
| H | 0.110 | 0.155 | 2.80 | 3.93 |
| J | 0.018 | 0.025 | 0.46 | 0.64 |
| K | 0.500 | 0.562 | 12.70 | 14.27 |
| L | 0.045 | 0.060 | 1.15 | 1.52 |
| N | 0.190 | 0.210 | 4.83 | 5.33 |
| Q | 0.100 | 0.120 | 2.54 | 3.04 |
| R | 0.080 | 0.110 | 2.04 | 2.79 |
| S | 0.020 | 0.024 | 0.508 | 0.61 |
| T | 0.235 | 0.255 | 5.97 | 6.47 |
| U | 0.000 | 0.050 | 0.00 | 1.27 |
| V | 0.045 | --- | 1.15 | --- |
| Z | --- | 0.080 | --- | 2.04 |

LM2931, NCV2931 Series

PACKAGE DIMENSIONS

TO-220 TH SUFFIX CASE 314A-03 ISSUE E

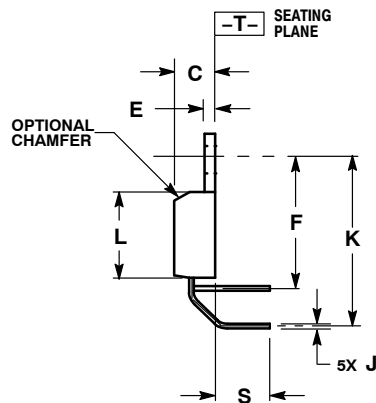
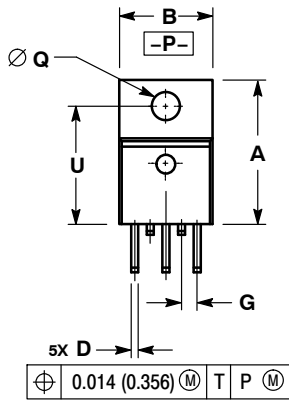

NOTES:

1. DIMENSIONING AND TOLERANCING PER ANSI Y14.5M, 1982.
2. CONTROLLING DIMENSION: INCH.
3. DIMENSION D DOES NOT INCLUDE INTERCONNECT BAR (DAMBAR) PROTRUSION. DIMENSION D INCLUDING PROTRUSION SHALL NOT EXCEED 0.043 (1.092) MAXIMUM.

| DIM | INCHES | | MILLIMETERS | |
|-----|-----------|-------|-------------|--------|
| | MIN | MAX | MIN | MAX |
| A | 0.572 | 0.613 | 14.529 | 15.570 |
| B | 0.390 | 0.415 | 9.906 | 10.541 |
| C | 0.170 | 0.180 | 4.318 | 4.572 |
| D | 0.025 | 0.038 | 0.635 | 0.965 |
| E | 0.048 | 0.055 | 1.219 | 1.397 |
| F | 0.570 | 0.585 | 14.478 | 14.859 |
| G | 0.067 BSC | | 1.702 BSC | |
| J | 0.015 | 0.025 | 0.381 | 0.635 |
| K | 0.730 | 0.745 | 18.542 | 18.923 |
| L | 0.320 | 0.365 | 8.128 | 9.271 |
| Q | 0.140 | 0.153 | 3.556 | 3.886 |
| S | 0.210 | 0.260 | 5.334 | 6.604 |
| U | 0.468 | 0.505 | 11.888 | 12.827 |

TO-220 TV SUFFIX CASE 314B-05 ISSUE L

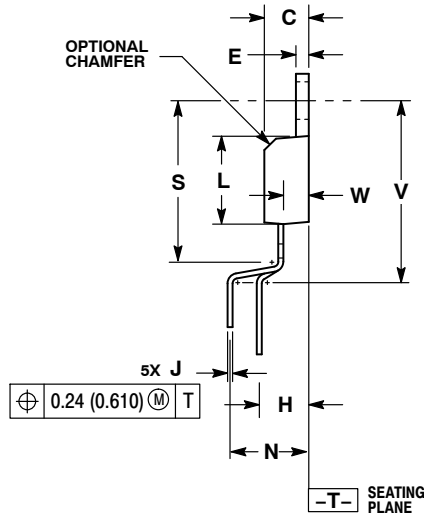
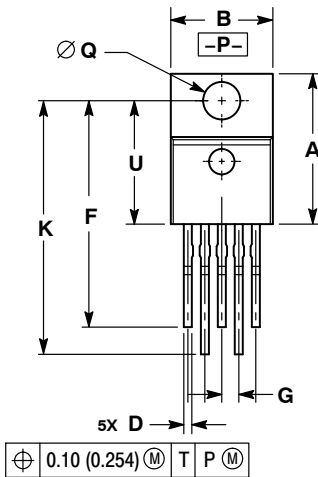

NOTES:

1. DIMENSIONING AND TOLERANCING PER ANSI Y14.5M, 1982.
2. CONTROLLING DIMENSION: INCH.
3. DIMENSION D DOES NOT INCLUDE INTERCONNECT BAR (DAMBAR) PROTRUSION. DIMENSION D INCLUDING PROTRUSION SHALL NOT EXCEED 0.043 (1.092) MAXIMUM.

| DIM | INCHES | | MILLIMETERS | |
|-----|-----------|-------|-------------|--------|
| | MIN | MAX | MIN | MAX |
| A | 0.572 | 0.613 | 14.529 | 15.570 |
| B | 0.390 | 0.415 | 9.906 | 10.541 |
| C | 0.170 | 0.180 | 4.318 | 4.572 |
| D | 0.025 | 0.038 | 0.635 | 0.965 |
| E | 0.048 | 0.055 | 1.219 | 1.397 |
| F | 0.850 | 0.935 | 21.590 | 23.749 |
| G | 0.067 BSC | | 1.702 BSC | |
| H | 0.166 BSC | | 4.216 BSC | |
| J | 0.015 | 0.025 | 0.381 | 0.635 |
| K | 0.900 | 1.100 | 22.860 | 27.940 |
| L | 0.320 | 0.365 | 8.128 | 9.271 |
| N | 0.320 BSC | | 8.128 BSC | |
| Q | 0.140 | 0.153 | 3.556 | 3.886 |
| S | --- | 0.620 | --- | 15.748 |
| U | 0.468 | 0.505 | 11.888 | 12.827 |
| V | --- | 0.735 | --- | 18.669 |
| W | 0.090 | 0.110 | 2.286 | 2.794 |

LM2931, NCV2931 Series

PACKAGE DIMENSIONS

TO-220 5-LEAD CASE 314D-04 ISSUE H

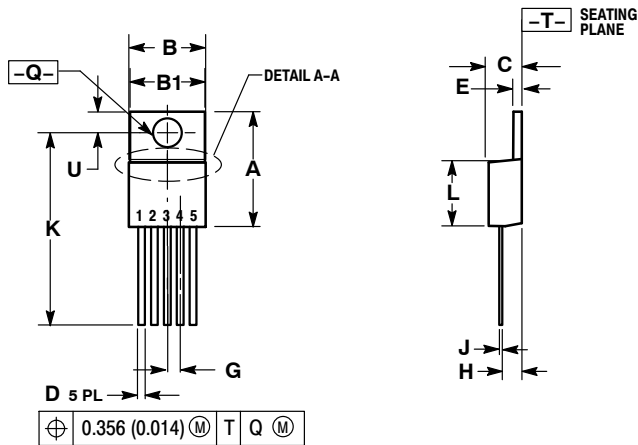

- NOTES:
1. DIMENSIONING AND TOLERANCING PER ANSI Y14.5M, 1982.
 2. CONTROLLING DIMENSION: INCH.
 3. DIMENSION D DOES NOT INCLUDE INTERCONNECT BAR (DAMBAR) PROTRUSION. DIMENSION D INCLUDING PROTRUSION SHALL NOT EXCEED 10.92 (0.043) MAXIMUM.

| DIM | INCHES | | MILLIMETERS | |
|-----|-----------|-------|-------------|--------|
| | MIN | MAX | MIN | MAX |
| A | 0.572 | 0.613 | 14.529 | 15.570 |
| B | 0.390 | 0.415 | 9.906 | 10.541 |
| B1 | 0.375 | 0.415 | 9.525 | 10.541 |
| C | 0.170 | 0.180 | 4.318 | 4.572 |
| D | 0.025 | 0.038 | 0.635 | 0.965 |
| E | 0.048 | 0.055 | 1.219 | 1.397 |
| G | 0.067 BSC | | 1.702 BSC | |
| H | 0.087 | 0.112 | 2.210 | 2.845 |
| J | 0.015 | 0.025 | 0.381 | 0.635 |
| K | 0.977 | 1.045 | 24.810 | 26.543 |
| L | 0.320 | 0.365 | 8.128 | 9.271 |
| Q | 0.140 | 0.153 | 3.556 | 3.886 |
| U | 0.105 | 0.117 | 2.667 | 2.972 |

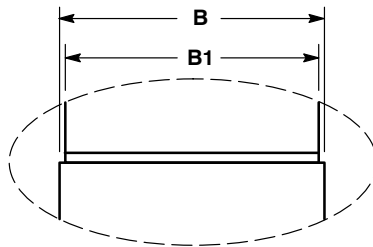

DETAIL A-A

SOT-223 ST SUFFIX CASE 318H-01 ISSUE O

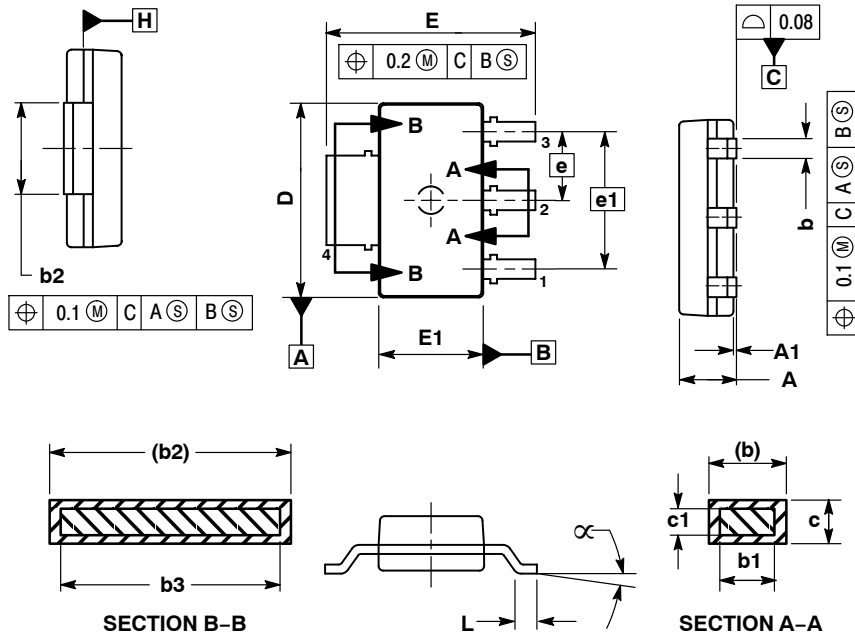

- NOTES:
1. DIMENSIONS ARE IN MILLIMETERS.
 2. INTERPRET DIMENSIONS AND TOLERANCES PER ASME Y14.5M, 1994.
 3. DIMENSION E1 DOES NOT INCLUDE INTERLEAD FLASH OR PROTRUSION. INTERLEAD FLASH OR PROTRUSION SHALL NOT EXCEED 0.23 PER SIDE.
 4. DIMENSIONS b AND b2 DO NOT INCLUDE DAMBAR PROTRUSION. ALLOWABLE DAMBAR PROTRUSION SHALL BE 0.08 TOTAL IN EXCESS OF THE b AND b2 DIMENSIONS AT MAXIMUM MATERIAL CONDITION.
 5. TERMINAL NUMBERS ARE SHOWN FOR REFERENCE ONLY.
 6. DIMENSIONS D AND E1 ARE TO BE DETERMINED AT DATUM PLANE H.

| DIM | MILLIMETERS | |
|----------|-------------|------|
| | MIN | MAX |
| A | --- | 1.80 |
| A1 | 0.02 | 0.11 |
| b | 0.60 | 0.88 |
| b1 | 0.60 | 0.80 |
| b2 | 2.90 | 3.10 |
| b3 | 2.90 | 3.05 |
| c | 0.24 | 0.35 |
| c1 | 0.24 | 0.30 |
| D | 6.30 | 6.70 |
| E | 6.70 | 7.30 |
| E1 | 3.30 | 3.70 |
| e | 2.30 | |
| e1 | 4.60 | |
| L | 0.25 | --- |
| ∞ | 0° | 10° |

LM2931, NCV2931 Series

PACKAGE DIMENSIONS

DPAK
DT SUFFIX
CASE 369C-01
ISSUE D

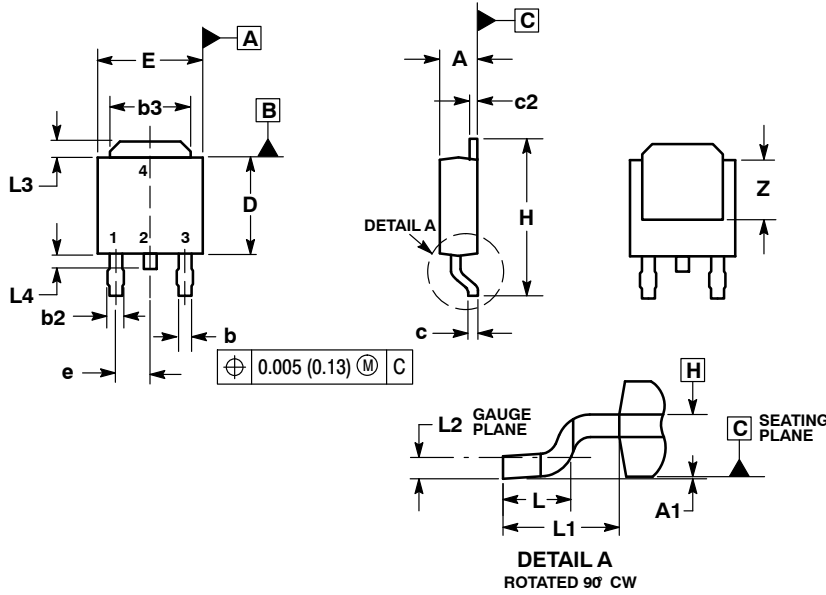

NOTES:

1. DIMENSIONING AND TOLERANCING PER ASME Y14.5M, 1994.
2. CONTROLLING DIMENSION: INCHES.
3. THERMAL PAD CONTOUR OPTIONAL WITHIN DIMENSIONS b3, L3 and Z.
4. DIMENSIONS D AND E DO NOT INCLUDE MOLD FLASH, PROTRUSIONS, OR BURRS. MOLD FLASH, PROTRUSIONS, OR GATE BURRS SHALL NOT EXCEED 0.006 INCHES PER SIDE.
5. DIMENSIONS D AND E ARE DETERMINED AT THE OUTERMOST EXTREMES OF THE PLASTIC BODY.
6. DATUMS A AND B ARE DETERMINED AT DATUM PLANE H.

| DIM | INCHES | | MILLIMETERS | |
|-----|--------|-------|-------------|-------|
| | MIN | MAX | MIN | MAX |
| A | 0.086 | 0.094 | 2.18 | 2.38 |
| A1 | 0.000 | 0.005 | 0.00 | 0.13 |
| b | 0.025 | 0.035 | 0.63 | 0.89 |
| b2 | 0.030 | 0.045 | 0.76 | 1.14 |
| b3 | 0.180 | 0.215 | 4.57 | 5.46 |
| c | 0.018 | 0.024 | 0.46 | 0.61 |
| c2 | 0.018 | 0.024 | 0.46 | 0.61 |
| D | 0.235 | 0.245 | 5.97 | 6.22 |
| E | 0.250 | 0.265 | 6.35 | 6.73 |
| e | 0.090 | BSC | 2.29 | BSC |
| H | 0.370 | 0.410 | 9.40 | 10.41 |
| L | 0.055 | 0.070 | 1.40 | 1.78 |
| L1 | 0.108 | REF | 2.74 | REF |
| L2 | 0.020 | BSC | 0.51 | BSC |
| L3 | 0.035 | 0.050 | 0.89 | 1.27 |
| L4 | --- | 0.040 | --- | 1.01 |
| Z | 0.155 | --- | 3.93 | --- |

SOLDERING FOOTPRINT*

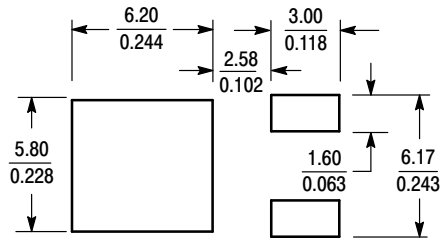

SCALE 3:1 ($\frac{\text{mm}}{\text{inches}}$)

*For additional information on our Pb-Free strategy and soldering details, please download the ON Semiconductor Soldering and Mounting Techniques Reference Manual, SOLDERRM/D.

LM2931, NCV2931 Series

PACKAGE DIMENSIONS

SOIC-8 NB
CASE 751-07
ISSUE AK

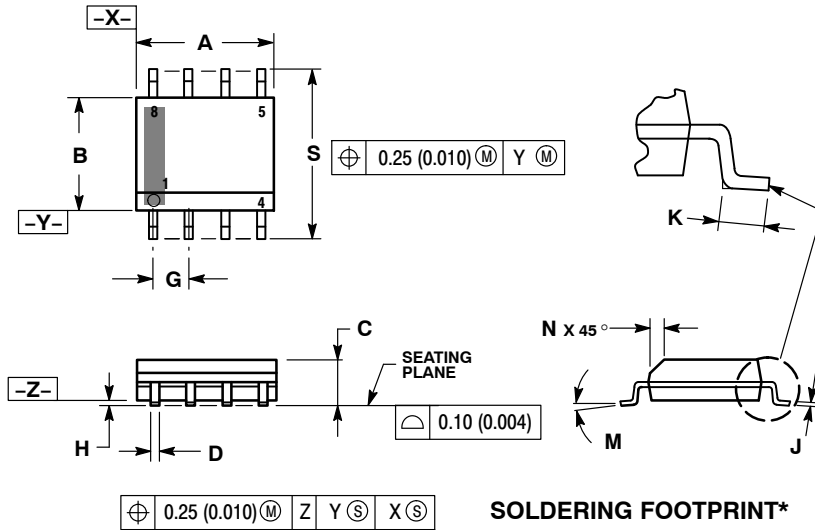

NOTES:

1. DIMENSIONING AND TOLERANCING PER ANSI Y14.5M, 1982.
2. CONTROLLING DIMENSION: MILLIMETER.
3. DIMENSION A AND B DO NOT INCLUDE MOLD PROTRUSION.
4. MAXIMUM MOLD PROTRUSION 0.15 (0.006) PER SIDE.
5. DIMENSION D DOES NOT INCLUDE DAMBAR PROTRUSION. ALLOWABLE DAMBAR PROTRUSION SHALL BE 0.127 (0.005) TOTAL IN EXCESS OF THE D DIMENSION AT MAXIMUM MATERIAL CONDITION.
6. 751-01 THRU 751-06 ARE OBSOLETE. NEW STANDARD IS 751-07.

| DIM | MILLIMETERS | | INCHES | |
|-----|-------------|------|-----------|-------|
| | MIN | MAX | MIN | MAX |
| A | 4.80 | 5.00 | 0.189 | 0.197 |
| B | 3.80 | 4.00 | 0.150 | 0.157 |
| C | 1.35 | 1.75 | 0.053 | 0.069 |
| D | 0.33 | 0.51 | 0.013 | 0.020 |
| G | 1.27 BSC | | 0.050 BSC | |
| H | 0.10 | 0.25 | 0.004 | 0.010 |
| J | 0.19 | 0.25 | 0.007 | 0.010 |
| K | 0.40 | 1.27 | 0.016 | 0.050 |
| M | 0° | 8° | 0° | 8° |
| N | 0.25 | 0.50 | 0.010 | 0.020 |
| S | 5.80 | 6.20 | 0.228 | 0.244 |

SOLDERING FOOTPRINT*

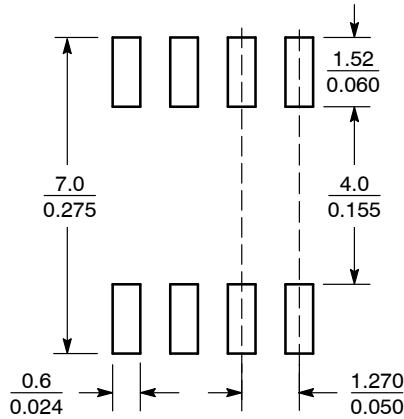

SCALE 6:1 $\left(\frac{\text{mm}}{\text{inches}} \right)$

*For additional information on our Pb-Free strategy and soldering details, please download the ON Semiconductor Soldering and Mounting Techniques Reference Manual, SOLDERRM/D.

LM2931, NCV2931 Series

PACKAGE DIMENSIONS

D²PAK
D2T SUFFIX
 CASE 936-03
 ISSUE D

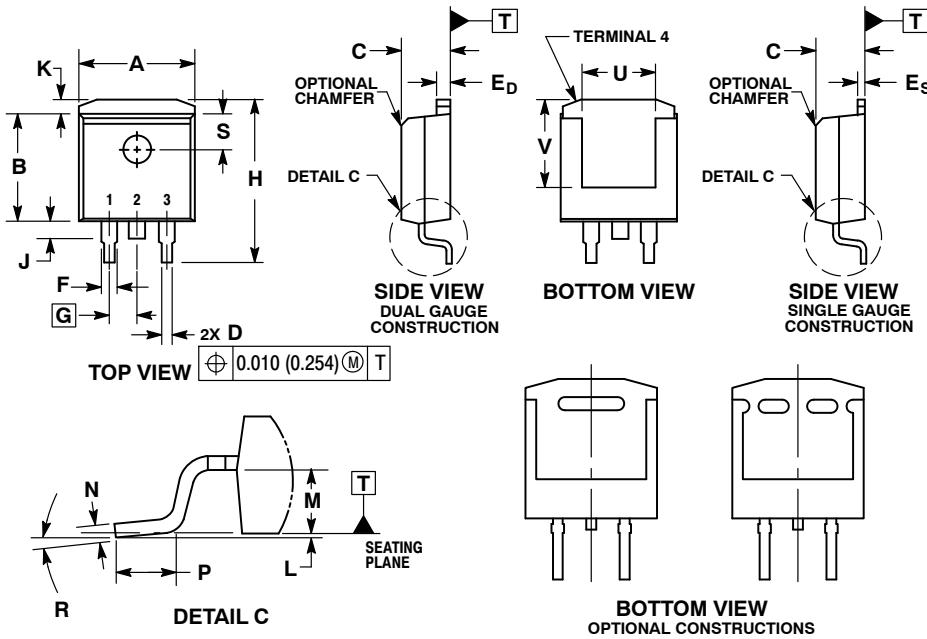

NOTES:

1. DIMENSIONING AND TOLERANCING PER ANSI Y14.5M, 1982.
2. CONTROLLING DIMENSION: INCHES.
3. TAB CONTOUR OPTIONAL WITHIN DIMENSIONS A AND K.
4. DIMENSIONS U AND V ESTABLISH A MINIMUM MOUNTING SURFACE FOR TERMINAL 4.
5. DIMENSIONS A AND B DO NOT INCLUDE MOLD FLASH OR GATE PROTRUSIONS. MOLD FLASH AND GATE PROTRUSIONS NOT TO EXCEED 0.025 (0.635) MAXIMUM.
6. SINGLE GAUGE DESIGN WILL BE SHIPPED AFTER FPCN EXPIRATION IN OCTOBER 2011.

| DIM | INCHES | | MILLIMETERS | |
|----------------|-----------|-------|-------------|--------|
| | MIN | MAX | MIN | MAX |
| A | 0.386 | 0.403 | 9.804 | 10.236 |
| B | 0.356 | 0.368 | 9.042 | 9.347 |
| C | 0.170 | 0.180 | 4.318 | 4.572 |
| D | 0.026 | 0.036 | 0.660 | 0.914 |
| E _D | 0.045 | 0.055 | 1.143 | 1.397 |
| E _S | 0.018 | 0.026 | 0.457 | 0.660 |
| F | 0.051 REF | | 1.295 REF | |
| G | 0.100 BSC | | 2.540 BSC | |
| H | 0.539 | 0.579 | 13.691 | 14.707 |
| J | 0.125 MAX | | 3.175 MAX | |
| K | 0.050 REF | | 1.270 REF | |
| L | 0.000 | 0.010 | 0.000 | 0.254 |
| M | 0.088 | 0.102 | 2.235 | 2.591 |
| N | 0.018 | 0.026 | 0.457 | 0.660 |
| P | 0.058 | 0.078 | 1.473 | 1.981 |
| R | 5° REF | | 5° REF | |
| S | 0.116 REF | | 2.946 REF | |
| U | 0.200 MIN | | 5.080 MIN | |
| V | 0.250 MIN | | 6.350 MIN | |

SOLDERING FOOTPRINT*

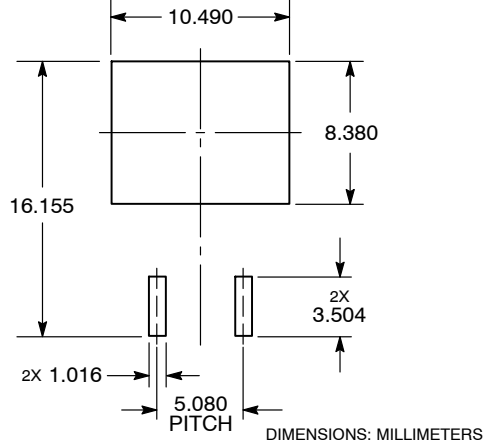

*For additional information on our Pb-Free strategy and soldering details, please download the ON Semiconductor Soldering and Mounting Techniques Reference Manual, SOLDERRM/D.

LM2931, NCV2931 Series

PACKAGE DIMENSIONS

D²PAK
D2T SUFFIX
CASE 936A-02
ISSUE C

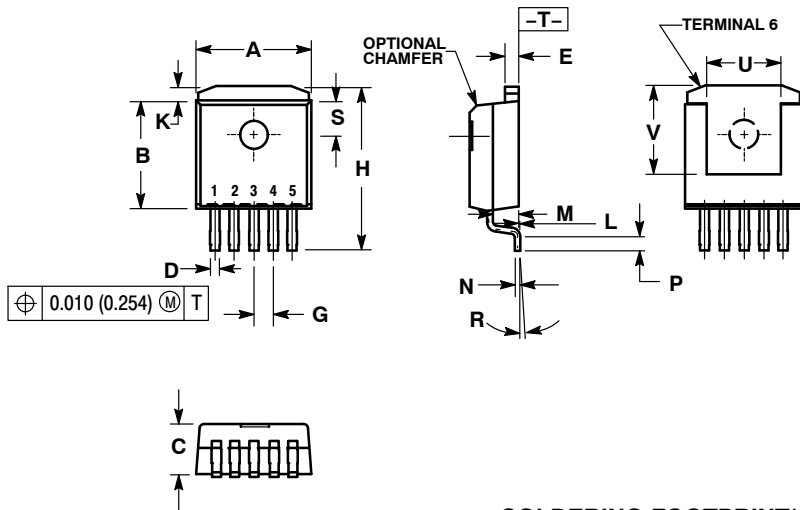

NOTES:

1. DIMENSIONING AND TOLERANCING PER ANSI Y14.5M, 1982.
2. CONTROLLING DIMENSION: INCH.
3. TAB CONTOUR OPTIONAL WITHIN DIMENSIONS A AND K.
4. DIMENSIONS U AND V ESTABLISH A MINIMUM MOUNTING SURFACE FOR TERMINAL 6.
5. DIMENSIONS A AND B DO NOT INCLUDE MOLD FLASH OR GATE PROTRUSIONS. MOLD FLASH AND GATE PROTRUSIONS NOT TO EXCEED 0.025 (0.635) MAXIMUM.

| DIM | INCHES | | MILLIMETERS | |
|-----|-----------|-------|-------------|--------|
| | MIN | MAX | MIN | MAX |
| A | 0.386 | 0.403 | 9.804 | 10.236 |
| B | 0.356 | 0.368 | 9.042 | 9.347 |
| C | 0.170 | 0.180 | 4.318 | 4.572 |
| D | 0.026 | 0.036 | 0.660 | 0.914 |
| E | 0.045 | 0.055 | 1.143 | 1.397 |
| G | 0.067 BSC | | 1.702 BSC | |
| H | 0.539 | 0.579 | 13.691 | 14.707 |
| K | 0.050 REF | | 1.270 REF | |
| L | 0.000 | 0.010 | 0.000 | 0.254 |
| M | 0.088 | 0.102 | 2.235 | 2.591 |
| N | 0.018 | 0.026 | 0.457 | 0.660 |
| P | 0.058 | 0.078 | 1.473 | 1.981 |
| R | 5° REF | | 5° REF | |
| S | 0.116 REF | | 2.946 REF | |
| U | 0.200 MIN | | 5.080 MIN | |
| V | 0.250 MIN | | 6.350 MIN | |

SOLDERING FOOTPRINT*

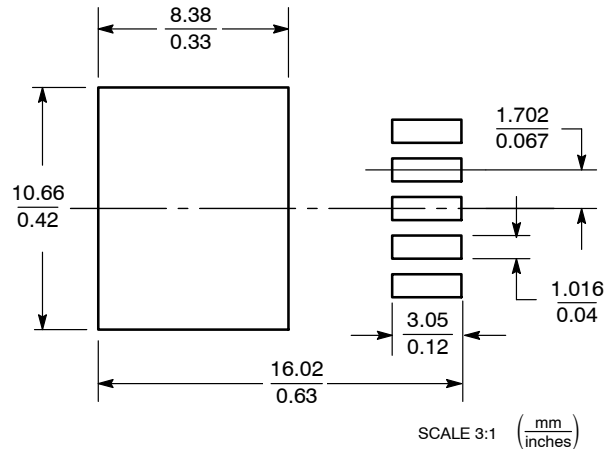

*For additional information on our Pb-Free strategy and soldering details, please download the ON Semiconductor Soldering and Mounting Techniques Reference Manual, SOLDERRM/D.

ON Semiconductor and are registered trademarks of Semiconductor Components Industries, LLC (SCILLC). SCILLC reserves the right to make changes without further notice to any products herein. SCILLC makes no warranty, representation or guarantee regarding the suitability of its products for any particular purpose, nor does SCILLC assume any liability arising out of the application or use of any product or circuit, and specifically disclaims any and all liability, including without limitation special, consequential or incidental damages. "Typical" parameters which may be provided in SCILLC data sheets and/or specifications can and do vary in different applications and actual performance may vary over time. All operating parameters, including "Typicals" must be validated for each customer application by customer's technical experts. SCILLC does not convey any license under its patent rights nor the rights of others. SCILLC products are not designed, intended, or authorized for use as components in systems intended for surgical implant into the body, or other applications intended to support or sustain life, or for any other application in which the failure of the SCILLC product could create a situation where personal injury or death may occur. Should Buyer purchase or use SCILLC products for any such unintended or unauthorized application, Buyer shall indemnify and hold SCILLC and its officers, employees, subsidiaries, affiliates, and distributors harmless against all claims, costs, damages, and expenses, and reasonable attorney fees arising out of, directly or indirectly, any claim of personal injury or death associated with such unintended or unauthorized use, even if such claim alleges that SCILLC was negligent regarding the design or manufacture of the part. SCILLC is an Equal Opportunity/Affirmative Action Employer. This literature is subject to all applicable copyright laws and is not for resale in any manner.

PUBLICATION ORDERING INFORMATION

LITERATURE FULFILLMENT:
Literature Distribution Center for ON Semiconductor
P.O. Box 5163, Denver, Colorado 80217 USA
Phone: 303-675-2175 or 800-344-3860 Toll Free USA/Canada
Fax: 303-675-2176 or 800-344-3867 Toll Free USA/Canada
Email: orderlit@onsemi.com

N. American Technical Support: 800-282-9855 Toll Free
USA/Canada
Europe, Middle East and Africa Technical Support:
Phone: 421 33 790 2910
Japan Customer Focus Center
Phone: 81-3-5817-1050

ON Semiconductor Website: www.onsemi.com
Order Literature: <http://www.onsemi.com/orderlit>
For additional information, please contact your local Sales Representative

Компания «Океан Электроники» предлагает заключение долгосрочных отношений при поставках импортных электронных компонентов на взаимовыгодных условиях!

Наши преимущества:

- Поставка оригинальных импортных электронных компонентов напрямую с производств Америки, Европы и Азии, а так же с крупнейших складов мира;
- Широкая линейка поставок активных и пассивных импортных электронных компонентов (более 30 млн. наименований);
- Поставка сложных, дефицитных, либо снятых с производства позиций;
- Оперативные сроки поставки под заказ (от 5 рабочих дней);
- Экспресс доставка в любую точку России;
- Помощь Конструкторского Отдела и консультации квалифицированных инженеров;
- Техническая поддержка проекта, помощь в подборе аналогов, поставка прототипов;
- Поставка электронных компонентов под контролем ВП;
- Система менеджмента качества сертифицирована по Международному стандарту ISO 9001;
- При необходимости вся продукция военного и аэрокосмического назначения проходит испытания и сертификацию в лаборатории (по согласованию с заказчиком);
- Поставка специализированных компонентов военного и аэрокосмического уровня качества (Xilinx, Altera, Analog Devices, Intersil, Interpoint, Microsemi, Actel, Aeroflex, Peregrine, VPT, Syfer, Eurofarad, Texas Instruments, MS Kennedy, Miteq, Cobham, E2V, MA-COM, Hittite, Mini-Circuits, General Dynamics и др.);

Компания «Океан Электроники» является официальным дистрибьютором и эксклюзивным представителем в России одного из крупнейших производителей разъемов военного и аэрокосмического назначения «JONHON», а так же официальным дистрибьютором и эксклюзивным представителем в России производителя высокотехнологичных и надежных решений для передачи СВЧ сигналов «FORSTAR».



JONHON

«JONHON» (основан в 1970 г.)

Разъемы специального, военного и аэрокосмического назначения:

(Применяются в военной, авиационной, аэрокосмической, морской, железнодорожной, горно- и нефтедобывающей отраслях промышленности)

«FORSTAR» (основан в 1998 г.)

ВЧ соединители, коаксиальные кабели, кабельные сборки и микроволновые компоненты:

(Применяются в телекоммуникациях гражданского и специального назначения, в средствах связи, РЛС, а так же военной, авиационной и аэрокосмической отраслях промышленности).



Телефон: 8 (812) 309-75-97 (многоканальный)

Факс: 8 (812) 320-03-32

Электронная почта: ocean@oceanchips.ru

Web: <http://oceanchips.ru/>

Адрес: 198099, г. Санкт-Петербург, ул. Калинина, д. 2, корп. 4, лит. А