



# NCR420Z / NCR421Z

150 mA LED driver in SOT223

Rev. 1 — 4 February 2019

Product data sheet

## 1. Product profile

### 1.1. General description

LED driver consisting of resistor-equipped NPN transistor with two diodes on one chip in a medium power SOT223 (SC73) plastic package.

Table 1. Product overview

Type number	Package	
	Nexperia	JEITA
NCR420Z	SOT223	SC-73
NCR421Z	SOT223	SC-73

### 1.2. Features and benefits

- Stabilized output current of 10 mA without external resistor
- Stabilized output current adjustable up to 150 mA when an external resistor is used
- High current accuracy at supply voltage variation
- Low voltage overhead of 1.4 V
- Reduces component count and board space
- High power dissipation of 1250 mW
- Supply voltage up to 40 V
- Digital PWM input up to 10 kHz frequency for NCR421Z
- AEC-Q101 qualified

### 1.3. Applications

- Constant current LED driver
- Generic constant current source
- Automotive applications (for example: interior lighting, dash board, instrumentation, number plate light)
- Increase stabilized output current by paralleling drivers

## 1.4. Quick reference data

Table 2. Quick reference data

Symbol	Parameter	Conditions	Min	Typ	Max	Unit
V <sub>EN</sub>	enable voltage					
	NCR420Z		-	-	40	V
	NCR421Z		-	-	4.5	V
V <sub>out</sub>	output voltage		-	-	40	V
I <sub>out</sub>	stabilized output current					
	NCR420Z	V <sub>out</sub> = 1.4 V; V <sub>EN</sub> = 24 V	[1] 9	10	11	mA
	NCR421Z	V <sub>out</sub> = 1.4 V; V <sub>EN</sub> = 3.3 V	[1] 9	10	11	mA

[1] Pulse test: t<sub>p</sub> ≤ 300 μs; δ ≤ 0.02

## 2. Pinning information

Table 3. Pinning

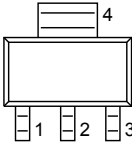
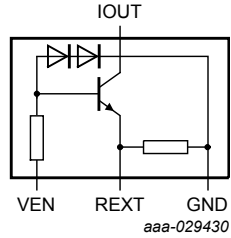
Pin	Symbol	Description	Simplified outline	Symbol
1	VEN	enable voltage		
2	REXT	external resistor		
3	GND	ground		
4	IOUT	output current		

## 3. Ordering information

Table 4. Ordering information

Type number	Package		
	Name	Description	Version
NCR420Z	SC-73	plastic surface-mounted package with increased heatsink; 4 leads	SOT223
NCR421Z	SC-73	plastic surface-mounted package with increased heatsink; 4 leads	SOT223

## 4. Marking

Table 5. Marking codes

Type number	Marking code
NCR420Z	CR420Z
NCR421Z	CR421Z

## 5. Limiting values

**Table 6. Limiting values**

In accordance with the Absolute Maximum Rating System (IEC 60134).

Symbol	Parameter	Conditions	Min	Max	Unit
$I_{out}$	stabilized output current if external resistor is used		-	200	mA
$V_{EN}$	enable voltage				
	NCR420Z		-	40	V
	NCR421Z		-	4.5	V
$V_{out}$	output voltage		-	40	V
$V_R$	reverse voltage		[1] -	0.5	V
$P_{tot}$	total power dissipation	$T_{amb} \leq 25\text{ °C}$	[2] -	765	mW
			[3] -	1160	mW
			[4] -	1250	mW
			[5] -	1800	mW
$T_j$	junction temperature		-	150	°C
$T_{amb}$	ambient temperature		-55	150	°C
$T_{stg}$	storage temperature		-65	150	°C

- [1] Between all terminals.
- [2] Device mounted on an FR4 Printed-Circuit Board (PCB), single-side copper (70  $\mu\text{m}$ ), tin-plated and standard footprint.
- [3] Device mounted on an FR4 Printed-Circuit Board (PCB), single-side copper (70  $\mu\text{m}$ ), tin-plated; mounting pad for collector 1  $\text{cm}^2$ .
- [4] Device mounted on an FR4 Printed-Circuit Board (PCB), 4-layer copper, tin-plated and standard footprint.
- [5] Device mounted on an FR4 Printed-Circuit Board (PCB), 4-layer copper, tin-plated; mounting pad for collector 1  $\text{cm}^2$ .

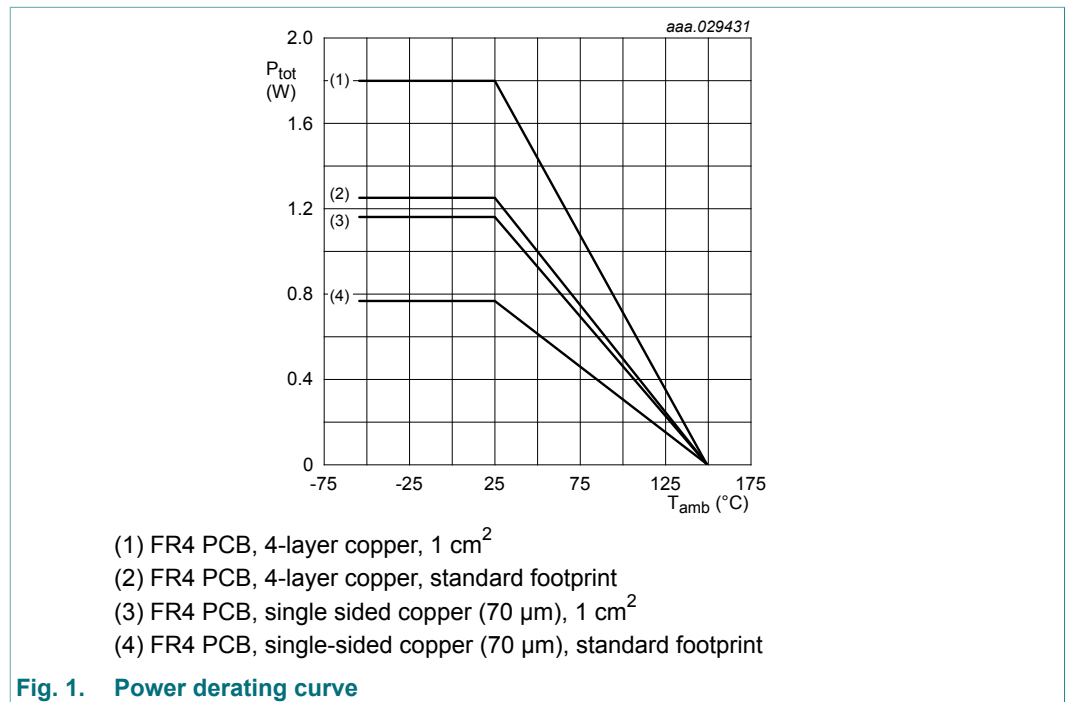

## 6. Thermal characteristics

Table 7. Thermal characteristics

Symbol	Parameter	Conditions	Min	Typ	Max	Unit	
$R_{th(j-a)}$	thermal resistance from junction to ambient	in free air	[1]	-	-	164	K/W
			[2]	-	-	108	K/W
			[3]	-	-	100	K/W
			[4]	-	-	70	K/W
$R_{th(j-sp)}$	thermal resistance from junction to solder point		-	-	27	K/W	

- [1] Device mounted on an FR4 PCB, single-sided copper (70  $\mu$ m), tin-plated and standard footprint.
- [2] Device mounted on an FR4 PCB, single-sided copper (70  $\mu$ m), tin-plated; mounting pad for collector 1  $cm^2$ .
- [3] Device mounted on an FR4 PCB, 4-layer copper, tin-plated and standard footprint.
- [4] Device mounted on an FR4 PCB, 4-layer copper, tin-plated; mounting pad for collector 1  $cm^2$ .

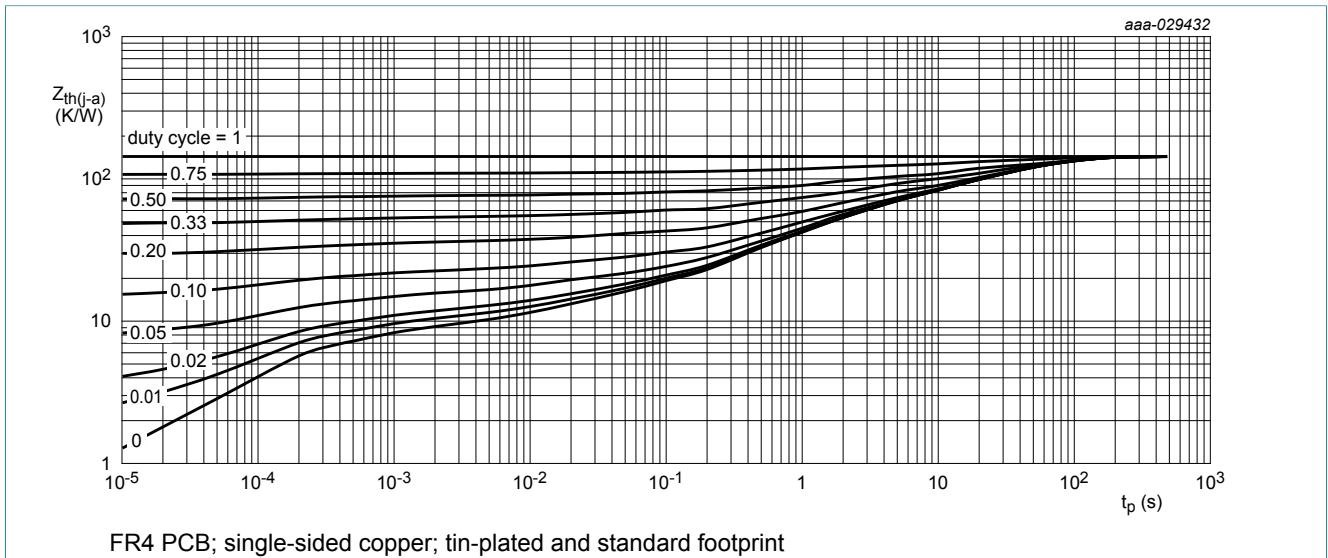

Fig. 2. Transient thermal impedance from junction to ambient as a function of pulse duration; typical values

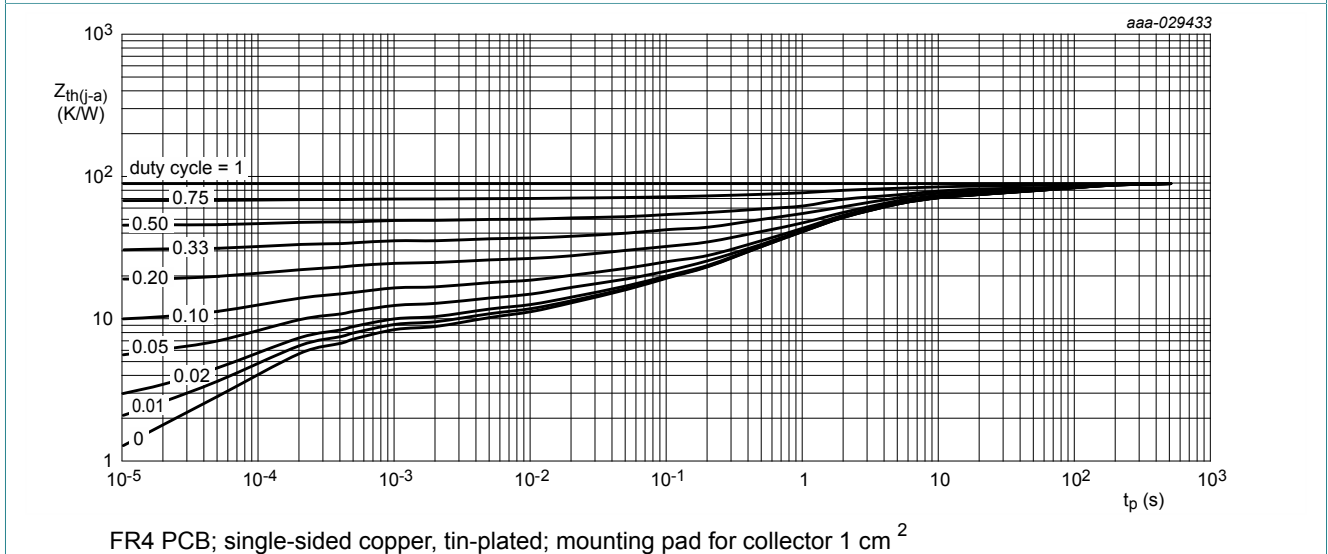

Fig. 3. Transient thermal impedance from junction to ambient as a function of pulse duration; typical values

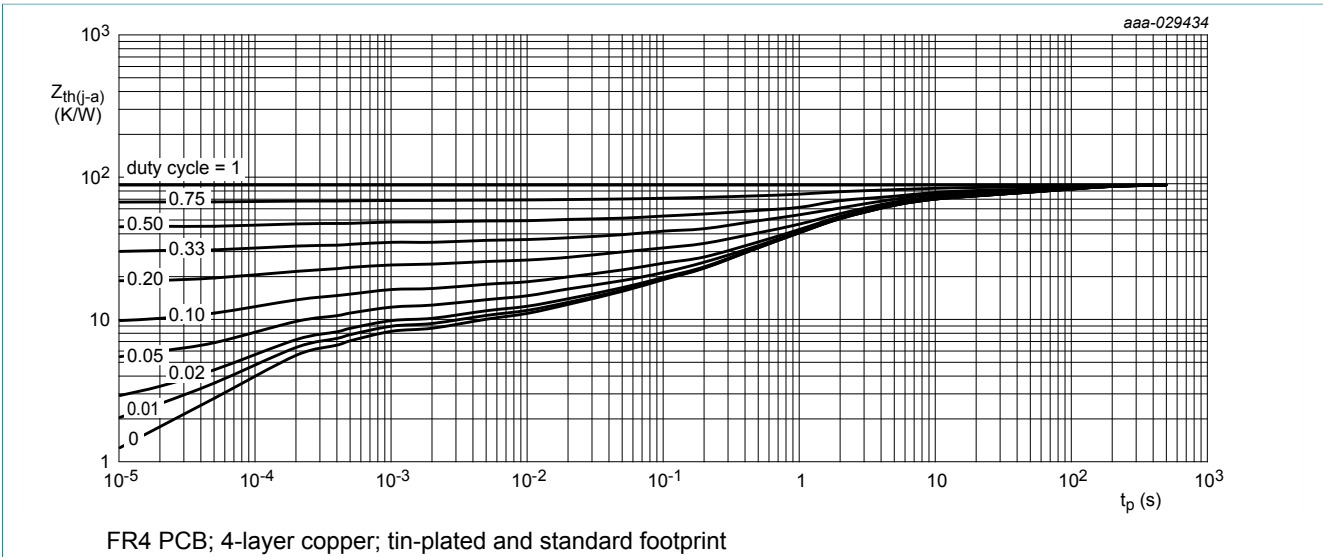

Fig. 4. Transient thermal impedance from junction to ambient as a function of pulse duration; typical values

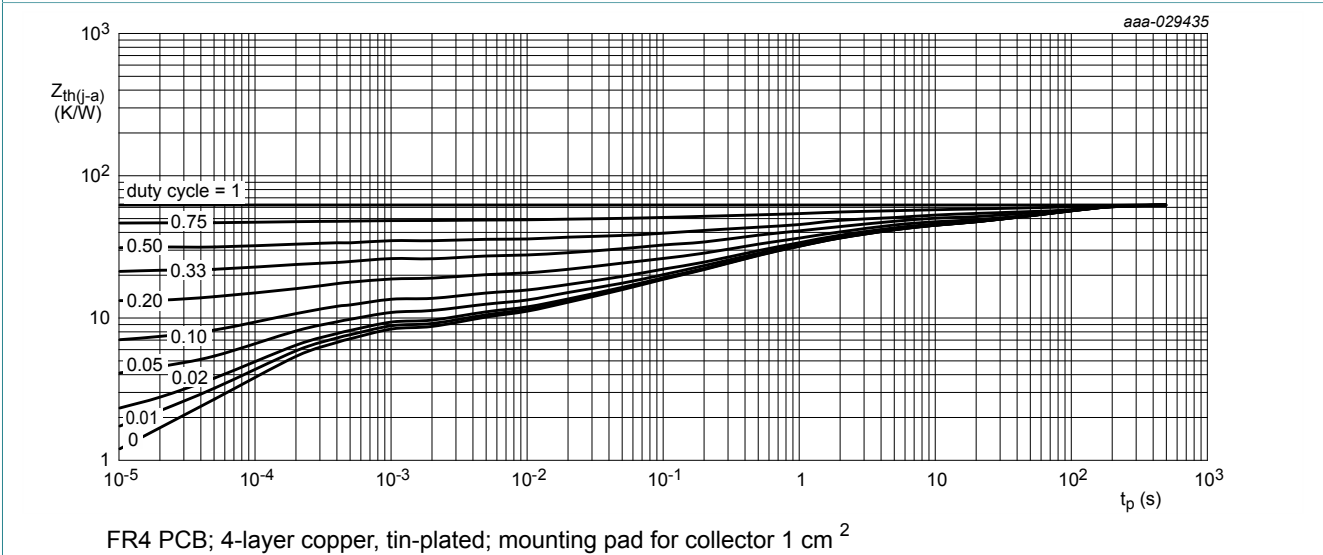

Fig. 5. Transient thermal impedance from junction to ambient as a function of pulse duration; typical values

## 7. Characteristics

**Table 8. Characteristics**
 $T_{amb} = 25\text{ °C}$  unless otherwise specified.

Symbol	Parameter	Conditions	Min	Typ	Max	Unit
$V_{(BR)CEO}$	collector-emitter breakdown voltage	$I_C = 1\text{ mA}$ ; $I_B = 0\text{ A}$	40	-	-	V
$h_{FE}$	DC current gain	$V_{CE} = 1\text{ V}$ ; $I_C = 50\text{ mA}$	[1] 200	350	-	
$R_{int}$	internal resistor	$I_{Rint} = 10\text{ mA}$	85	95	105	$\Omega$
$V_{Rint}$	voltage drop at internal resistor $R_{int}$	$I_{out} = 10\text{ mA}$	[1] 0.85	0.95	1.05	V
$I_{EN}$	enable current					
	NCR420Z	$V_{EN} = 24\text{ V}$	[1] -	1.2	-	mA
	NCR421Z	$V_{EN} = 3.3\text{ V}$	[1] -	1.2	-	mA
$R_B$	bias resistor					
	NCR420Z		-	20	-	k $\Omega$
	NCR421Z		-	1.5	-	k $\Omega$
$I_{out}$	stabilized output current					
	NCR420Z	$V_{EN} = 24\text{ V}$ ; $V_{out} = 1.4\text{ V}$	[1] 9	10	11	mA
	NCR421Z	$V_{EN} = 3.3\text{ V}$ ; $V_{out} = 1.4\text{ V}$	[1] 9	10	11	mA
$I_{out}$	stabilized output current					
	NCR420Z at $R_{ext} = 5.1\text{ }\Omega$	$V_{EN} = 24\text{ V}$ ; $V_{out} > 2\text{ V}$	[1] -	150	-	mA
	NCR421Z at $R_{ext} = 5.1\text{ }\Omega$	$V_{EN} = 3.3\text{ V}$ ; $V_{out} > 2\text{ V}$	[1] -	150	-	mA
$V_{out, min}$	lowest sufficient output voltage overhead: $V_{out} = V_{CC} - V_{LED}$	$I_{out} > 10\text{ mA}$	-	1.4	-	V
$\Delta I_{out}/(I_{out} \times \Delta T_{amb})$	stabilized output current change over ambient temperature					
	NCR420Z	$V_{EN} = 24\text{ V}$ ; $V_{out} > 2\text{ V}$	[1] -	-0.27	-	%/K
	NCR421Z	$V_{EN} = 3.3\text{ V}$ ; $V_{out} > 2\text{ V}$	[1] -	-0.27	-	%/K
$\Delta I_{out}/(I_{out} \times \Delta V_{CC})$	stabilized output current change over supply voltage					
	NCR420Z	$V_{EN} = 24\text{ V}$ ; $V_{out} > 2\text{ V}$	[1] -	1	-	%/V
	NCR421Z	$V_{EN} = 3.3\text{ V}$ ; $V_{out} > 2\text{ V}$	[1] -	1	-	%/V

[1] Pulse test:  $t_p \leq 300\text{ }\mu\text{s}$ ;  $\delta \leq 0.02$ .

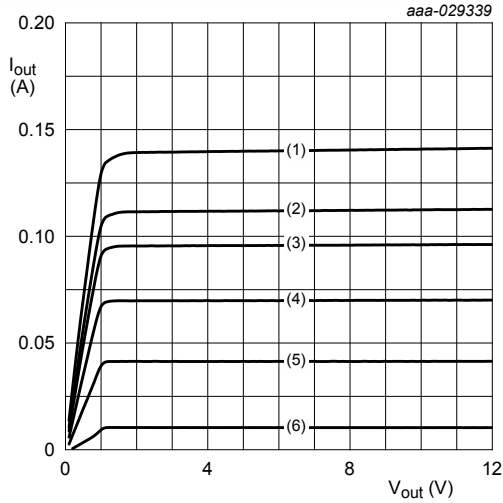

$V_{EN} = 40\text{ V}; T_{amb} = 25\text{ }^{\circ}\text{C}$   
 (1)  $R_{ext} = 6\text{ }\Omega$   
 (2)  $R_{ext} = 8\text{ }\Omega$   
 (3)  $R_{ext} = 10\text{ }\Omega$   
 (4)  $R_{ext} = 15\text{ }\Omega$   
 (5)  $R_{ext} = 30\text{ }\Omega$   
 (6)  $R_{ext} = \text{open}$

**Fig. 6. NCR420Z: Output current as a function of output voltage; typical values**

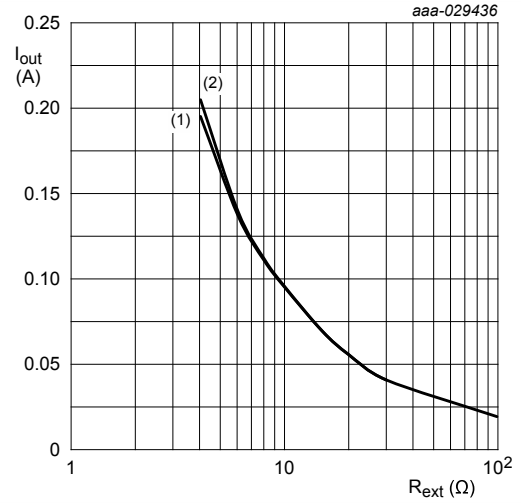

$V_{EN} = 40\text{ V}; T_{amb} = 25\text{ }^{\circ}\text{C}$   
 (1)  $V_{out} = 1.4\text{ V}$   
 (2)  $V_{out} = 5.4\text{ V}$

**Fig. 7. NCR420Z: Output current as a function of external resistor; typical values**

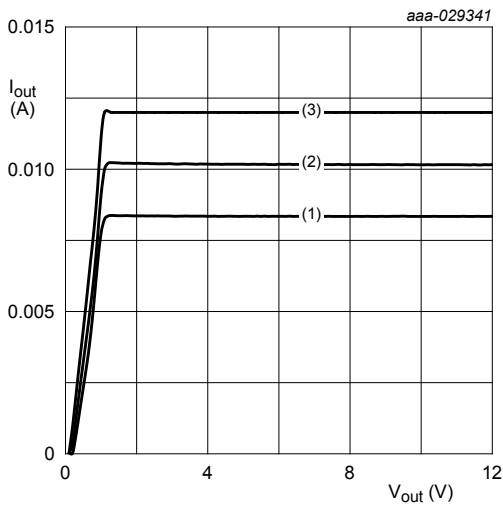

$V_{EN} = 40\text{ V}; R_{ext} = \text{open}$   
 (1)  $T_{amb} = 85\text{ }^{\circ}\text{C}$   
 (2)  $T_{amb} = 25\text{ }^{\circ}\text{C}$   
 (3)  $T_{amb} = -40\text{ }^{\circ}\text{C}$

**Fig. 8. NCR420Z: Output current as a function of output voltage; typical values**

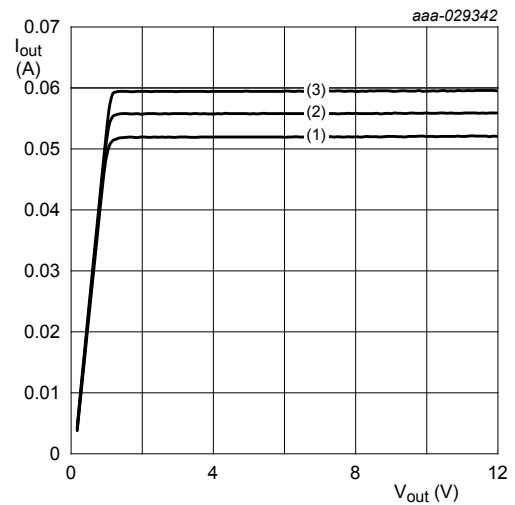

$V_{EN} = 40\text{ V}; R_{ext} = 20\text{ }\Omega$   
 (1)  $T_{amb} = 85\text{ }^{\circ}\text{C}$   
 (2)  $T_{amb} = 25\text{ }^{\circ}\text{C}$   
 (3)  $T_{amb} = -40\text{ }^{\circ}\text{C}$

**Fig. 9. NCR420Z: Output current as a function of output voltage; typical values**

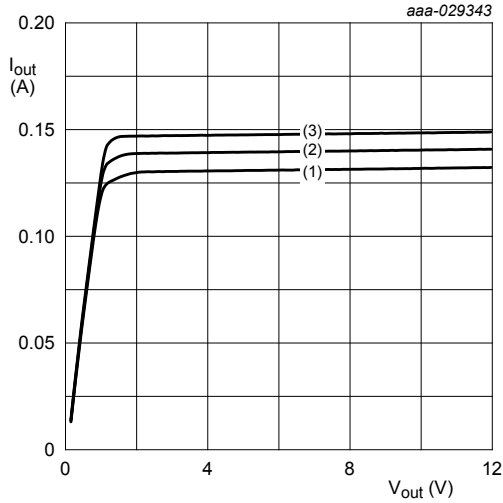

$V_{EN} = 40 \text{ V}; R_{ext} = 6 \Omega$

- (1)  $T_{amb} = 85 \text{ }^\circ\text{C}$
- (2)  $T_{amb} = 25 \text{ }^\circ\text{C}$
- (3)  $T_{amb} = -40 \text{ }^\circ\text{C}$

Fig. 10. NCR420Z: Output current as a function of output voltage; typical values

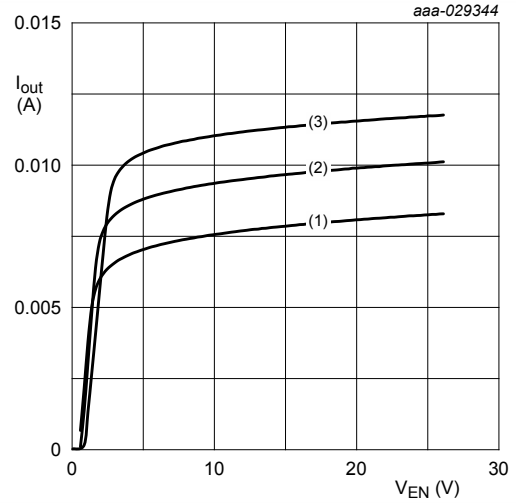

$V_{out} = 2 \text{ V}; R_{ext} = \text{open}$

- (1)  $T_{amb} = 85 \text{ }^\circ\text{C}$
- (2)  $T_{amb} = 25 \text{ }^\circ\text{C}$
- (3)  $T_{amb} = -40 \text{ }^\circ\text{C}$

Fig. 11. NCR420Z: Output current as a function of enable voltage; typical values

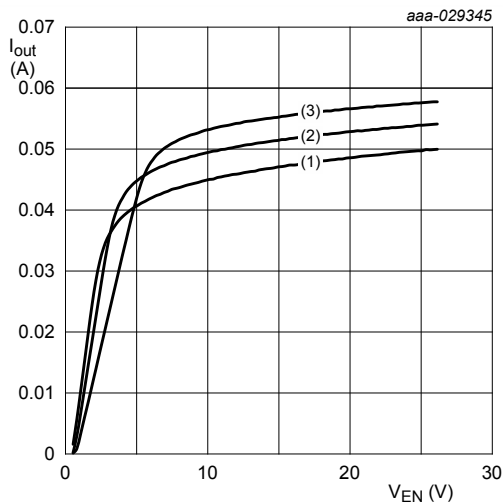

$V_{out} = 2 \text{ V}; R_{ext} = 20 \Omega$

- (1)  $T_{amb} = 85 \text{ }^\circ\text{C}$
- (2)  $T_{amb} = 25 \text{ }^\circ\text{C}$
- (3)  $T_{amb} = -40 \text{ }^\circ\text{C}$

Fig. 12. NCR420Z: Output current as a function of enable voltage; typical values

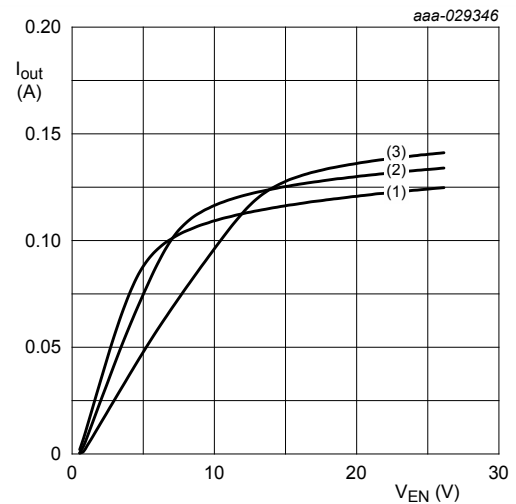

$V_{out} = 2 \text{ V}; R_{ext} = 6 \Omega$

- (1)  $T_{amb} = 85 \text{ }^\circ\text{C}$
- (2)  $T_{amb} = 25 \text{ }^\circ\text{C}$
- (3)  $T_{amb} = -40 \text{ }^\circ\text{C}$

Fig. 13. NCR420Z: Output current as a function of enable voltage; typical values



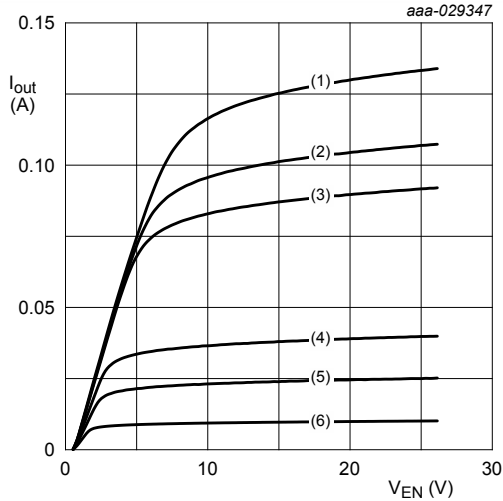

$V_{out} = 2 \text{ V}; T_{amb} = 25 \text{ }^\circ\text{C}$

- (1)  $R_{ext} = 6 \text{ } \Omega$
- (2)  $R_{ext} = 8 \text{ } \Omega$
- (3)  $R_{ext} = 10 \text{ } \Omega$
- (4)  $R_{ext} = 30 \text{ } \Omega$
- (5)  $R_{ext} = 60 \text{ } \Omega$
- (6)  $R_{ext} = \text{open}$

**Fig. 14. NCR420Z: Output current as a function of enable voltage; typical values**

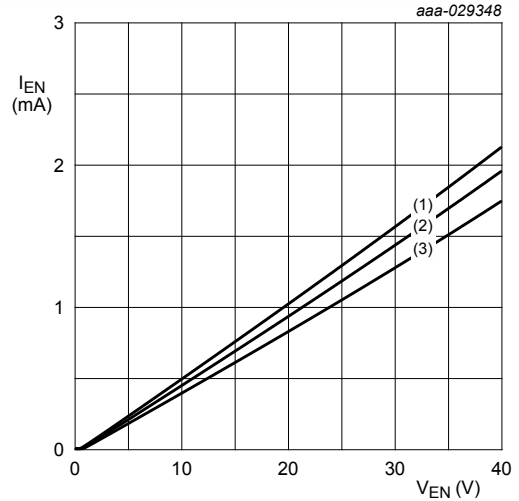

$I_{out} = 0 \text{ A}; R_{ext} = \text{open}$

- (1)  $T_{amb} = 85 \text{ }^\circ\text{C}$
- (2)  $T_{amb} = 25 \text{ }^\circ\text{C}$
- (3)  $T_{amb} = -40 \text{ }^\circ\text{C}$

**Fig. 15. NCR420Z: Enable current as a function of enable voltage; typical values**

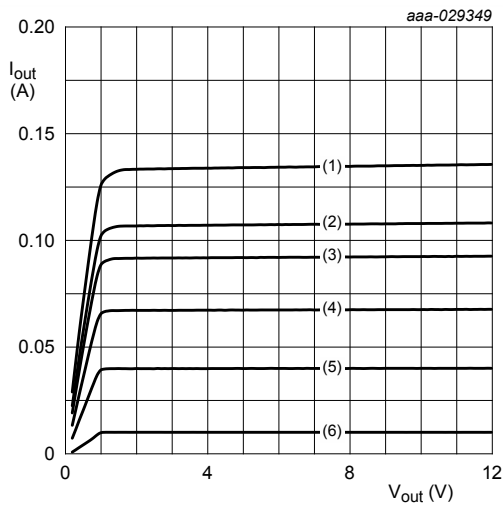

$V_{EN} = 3.3 \text{ V}; T_{amb} = 25 \text{ }^\circ\text{C}$

- (1)  $R_{ext} = 6 \text{ } \Omega$
- (2)  $R_{ext} = 8 \text{ } \Omega$
- (3)  $R_{ext} = 10 \text{ } \Omega$
- (4)  $R_{ext} = 15 \text{ } \Omega$
- (5)  $R_{ext} = 30 \text{ } \Omega$
- (6)  $R_{ext} = \text{open}$

**Fig. 16. NCR421Z: Output current as a function of output voltage; typical values**

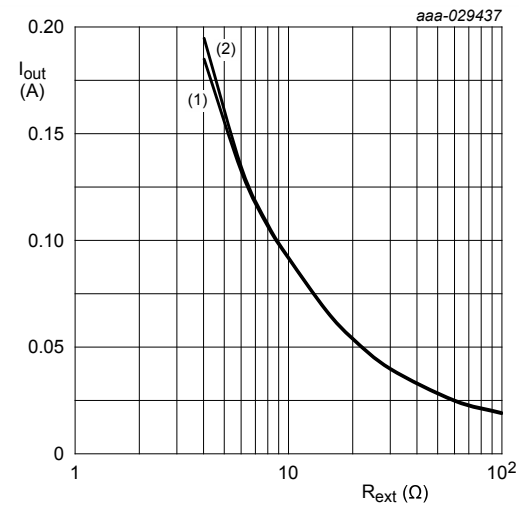

$V_{EN} = 3.3 \text{ V}; T_{amb} = 25 \text{ }^\circ\text{C}$

- (1)  $V_{out} = 1.4 \text{ V}$
- (2)  $V_{out} = 5.4 \text{ V}$

**Fig. 17. NCR421Z: Output current as a function of external resistor; typical values**

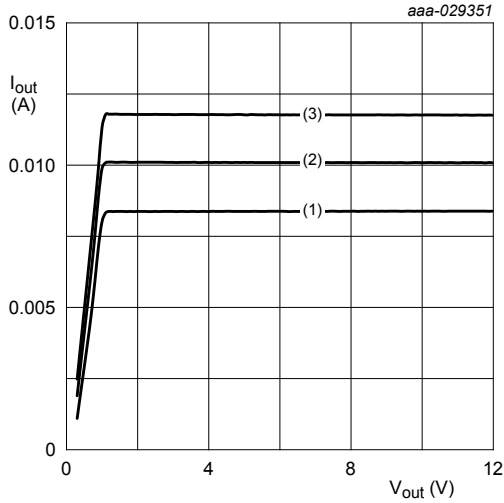

$V_{EN} = 3.3\text{ V}$ ;  $R_{ext} = \text{open}$

- (1)  $R_{ext} = 85\text{ }^{\circ}\text{C}$
- (2)  $R_{ext} = 25\text{ }^{\circ}\text{C}$
- (3)  $R_{ext} = -40\text{ }^{\circ}\text{C}$

**Fig. 18. NCR421Z: Output current as a function of output voltage; typical values**

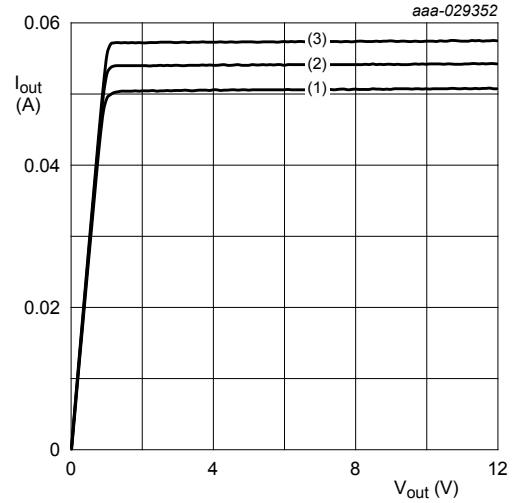

$V_{EN} = 3.3\text{ V}$ ;  $R_{ext} = 20\text{ }\Omega$

- (1)  $R_{ext} = 85\text{ }^{\circ}\text{C}$
- (2)  $R_{ext} = 25\text{ }^{\circ}\text{C}$
- (3)  $R_{ext} = -40\text{ }^{\circ}\text{C}$

**Fig. 19. NCR421Z: Output current as a function of output voltage; typical values**

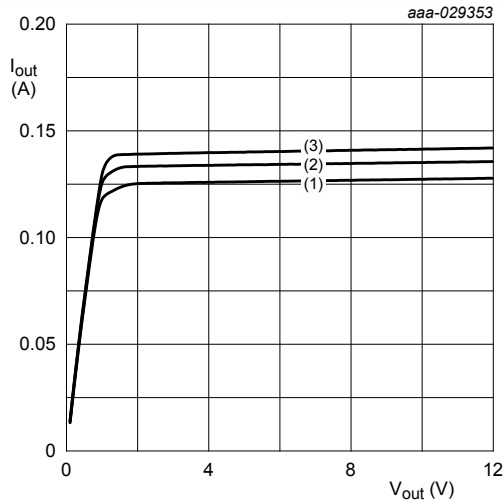

$V_{EN} = 3.3\text{ V}$ ;  $R_{ext} = 6\text{ }\Omega$

- (1)  $R_{ext} = 85\text{ }^{\circ}\text{C}$
- (2)  $R_{ext} = 25\text{ }^{\circ}\text{C}$
- (3)  $R_{ext} = -40\text{ }^{\circ}\text{C}$

**Fig. 20. NCR421Z: Output current as a function of output voltage; typical values**

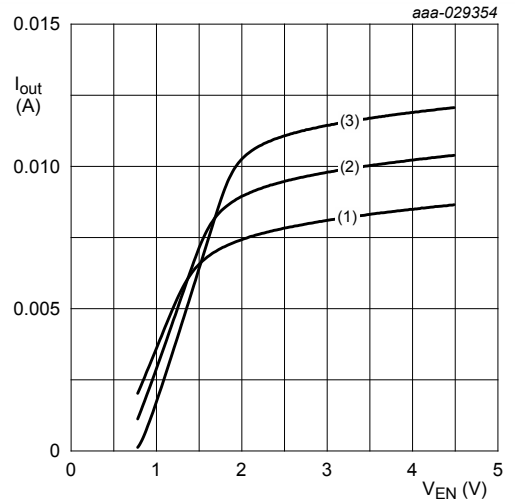

$V_{out} = 2\text{ V}$ ;  $R_{ext} = \text{open}$

- (1)  $R_{ext} = 85\text{ }^{\circ}\text{C}$
- (2)  $R_{ext} = 25\text{ }^{\circ}\text{C}$
- (3)  $R_{ext} = -40\text{ }^{\circ}\text{C}$

**Fig. 21. NCR421Z: Output current as a function of enable voltage; typical values**

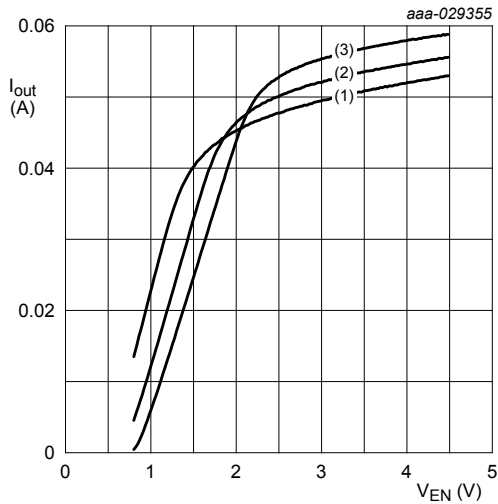

$V_{out} = 2\text{ V}; R_{ext} = 20\ \Omega$

- (1)  $R_{ext} = 85\ ^\circ\text{C}$
- (2)  $R_{ext} = 25\ ^\circ\text{C}$
- (3)  $R_{ext} = -40\ ^\circ\text{C}$

Fig. 22. NCR421Z: Output current as a function of enable voltage; typical values

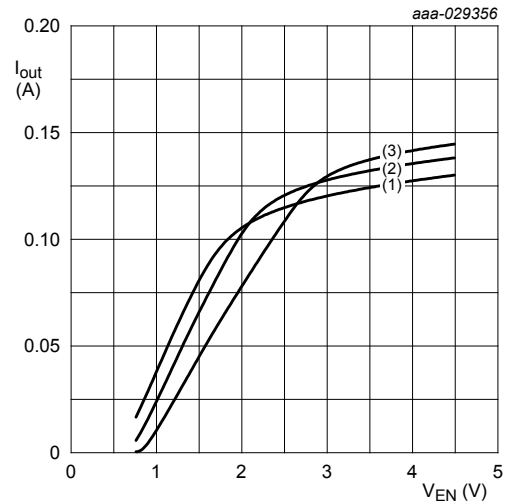

$V_{out} = 2\text{ V}; R_{ext} = 6\ \Omega$

- (1)  $R_{ext} = 85\ ^\circ\text{C}$
- (2)  $R_{ext} = 25\ ^\circ\text{C}$
- (3)  $R_{ext} = -40\ ^\circ\text{C}$

Fig. 23. NCR421Z: Output current as a function of enable voltage; typical values

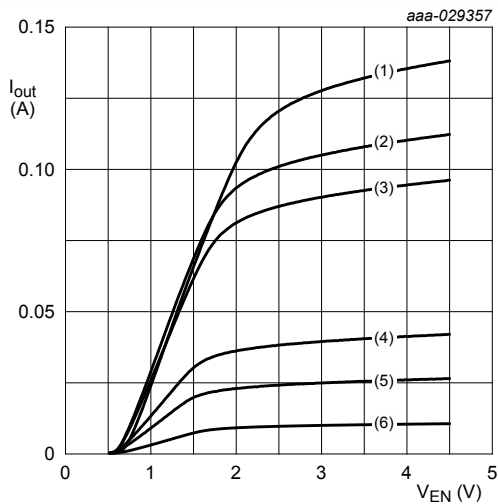

$V_{out} = 2\text{ V}; T_{amb} = 25\ ^\circ\text{C}$

- (1)  $R_{ext} = 6\ \Omega$
- (2)  $R_{ext} = 8\ \Omega$
- (3)  $R_{ext} = 10\ \Omega$
- (4)  $R_{ext} = 30\ \Omega$
- (5)  $R_{ext} = 60\ \Omega$
- (6)  $R_{ext} = \text{open}$

Fig. 24. NCR421Z: Output current as a function of enable voltage; typical values

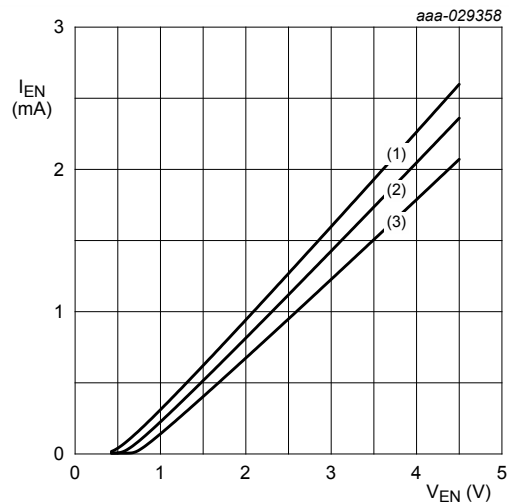

$I_{out} = 0\text{ A}; R_{ext} = \text{open}$

- (1)  $T_{amb} = 85\ ^\circ\text{C}$
- (2)  $T_{amb} = 25\ ^\circ\text{C}$
- (3)  $T_{amb} = -40\ ^\circ\text{C}$

Fig. 25. NCR421Z: Enable current as a function of enable voltage; typical values

### 8. Application information

Figure 26 shows a typical application circuit for an LED driver. The constant current ensures a constant brightness in all LEDs. The output current can be adjusted between 10 mA and 150 mA by connecting resistor  $R_{ext}$ . Figures 7 and 17 give a first indication for choosing the external resistor  $R_{ext}$ . The minimum input voltage is given by voltage drop at the LED's  $V_{LED}$  and the maximum is governed by the maximum power dissipation

$$V_{LED} + V_{out, min} < V_{CC} < P_{tot} / I_{out} + V_{LED}$$

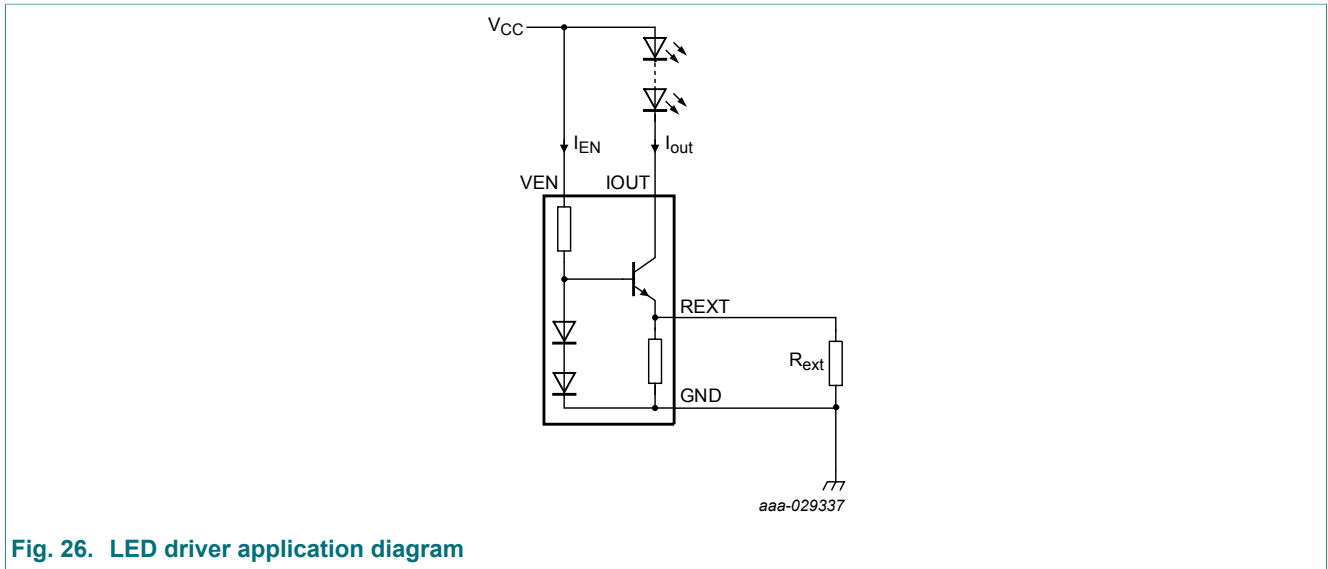

Fig. 26. LED driver application diagram

NCR421Z can be used for PWM dimming or on/off function by driving the VEN pin. The enable voltage depends on the drive current, see Figure 23. Figure 27 shows a typical application where VEN is driven via a micro directly. To control more than one NCR421Z devices by one microcontroller output, a shift register (for example 74AHC(T)594PW) can be used.

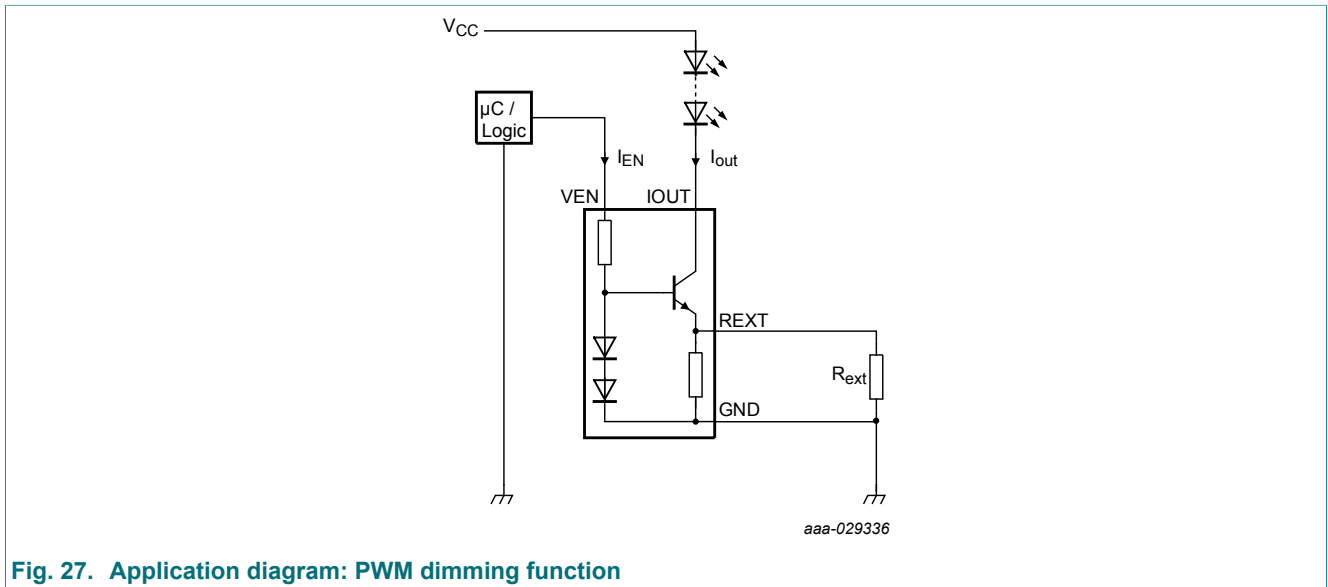

Fig. 27. Application diagram: PWM dimming function

To safely drive currents that are above the limits of the NCR42xZ, two or more devices can be parallel connected as illustrated in Figure 28. When choosing the same values for the external resistors, the drive current splits equally and the capability of handling excess power is doubled. Both, NCR420Z and NCR421Z can be used in this configuration.

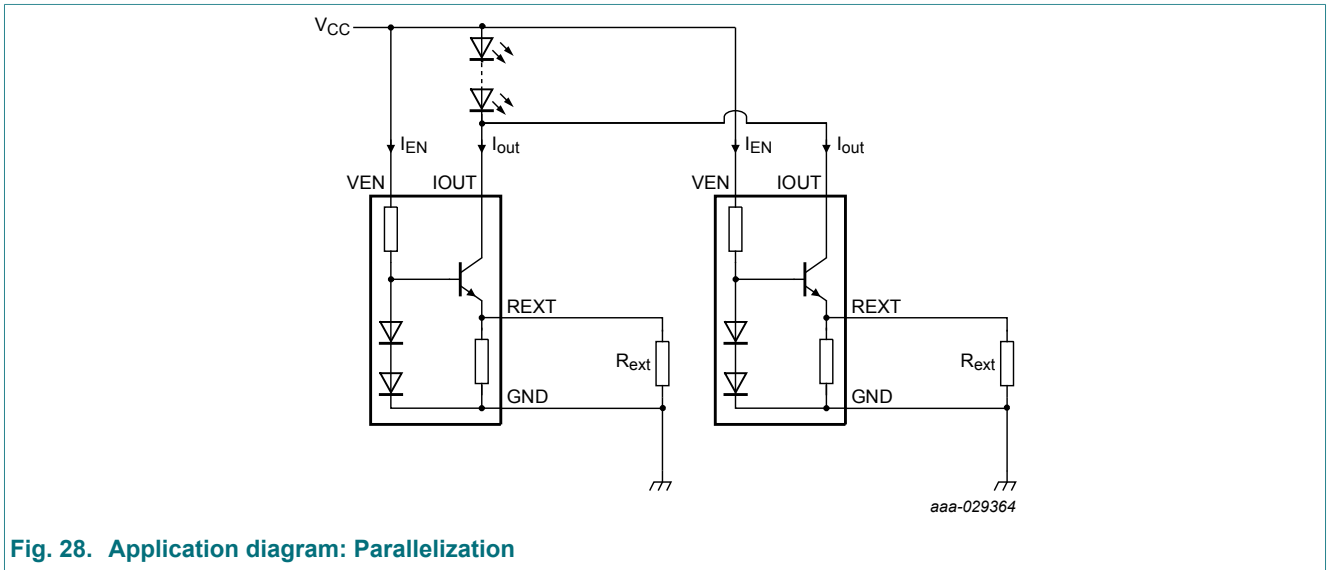

Fig. 28. Application diagram: Parallelization

### 9. Package outline

Table 9. Package outline

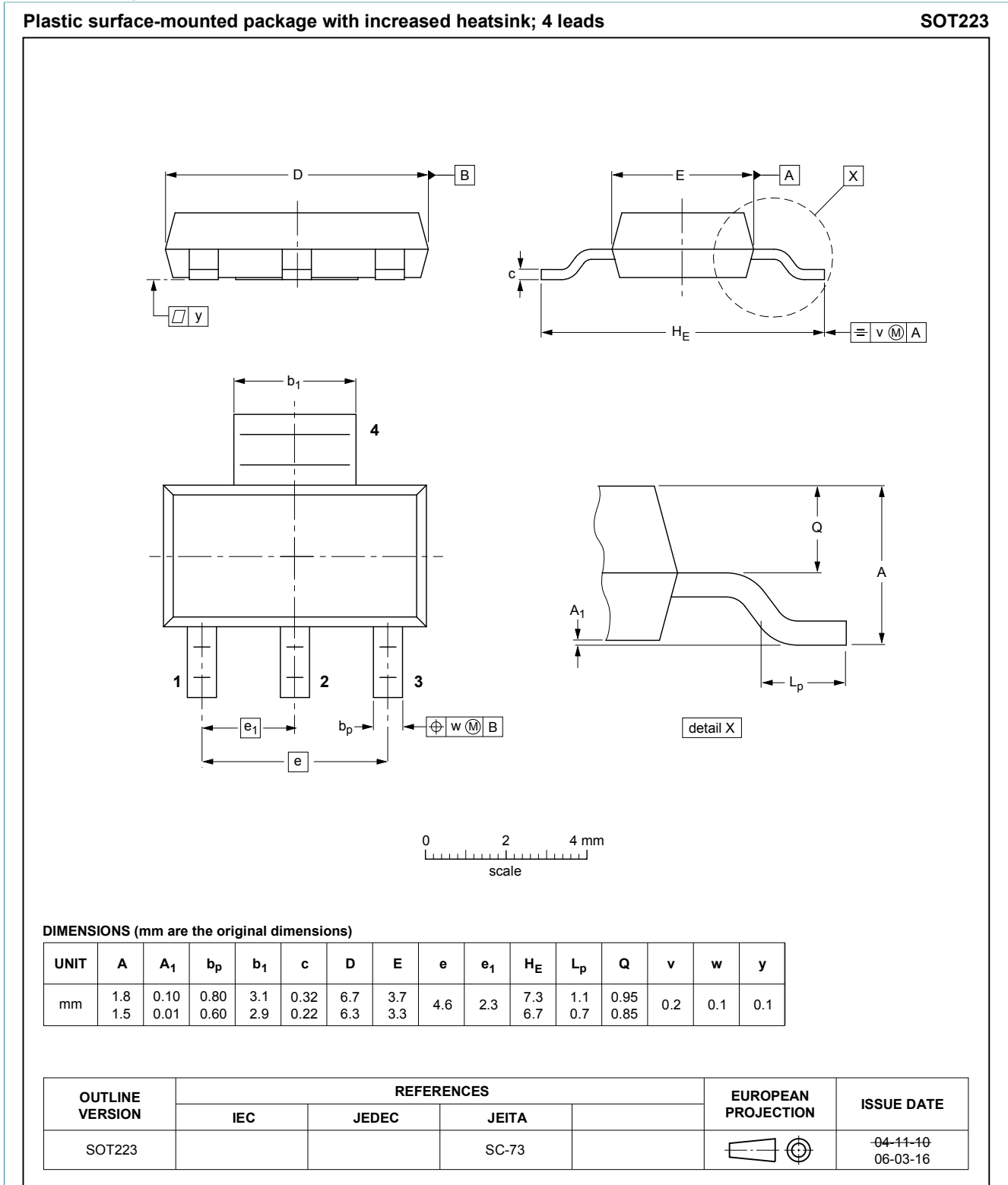

Fig. 29. Package outline SC-73 (SOT223)

### 10. Soldering

Table 10. Soldering

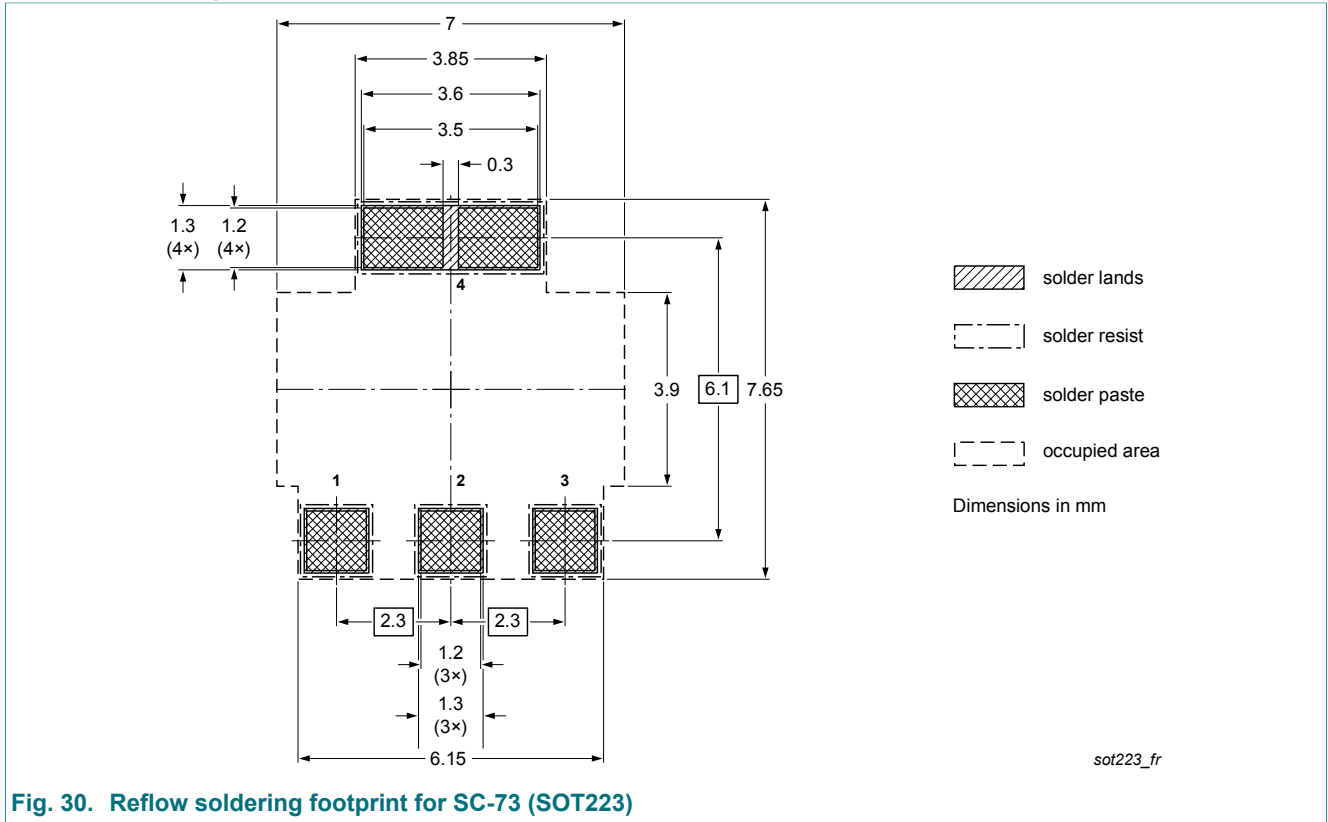

Fig. 30. Reflow soldering footprint for SC-73 (SOT223)

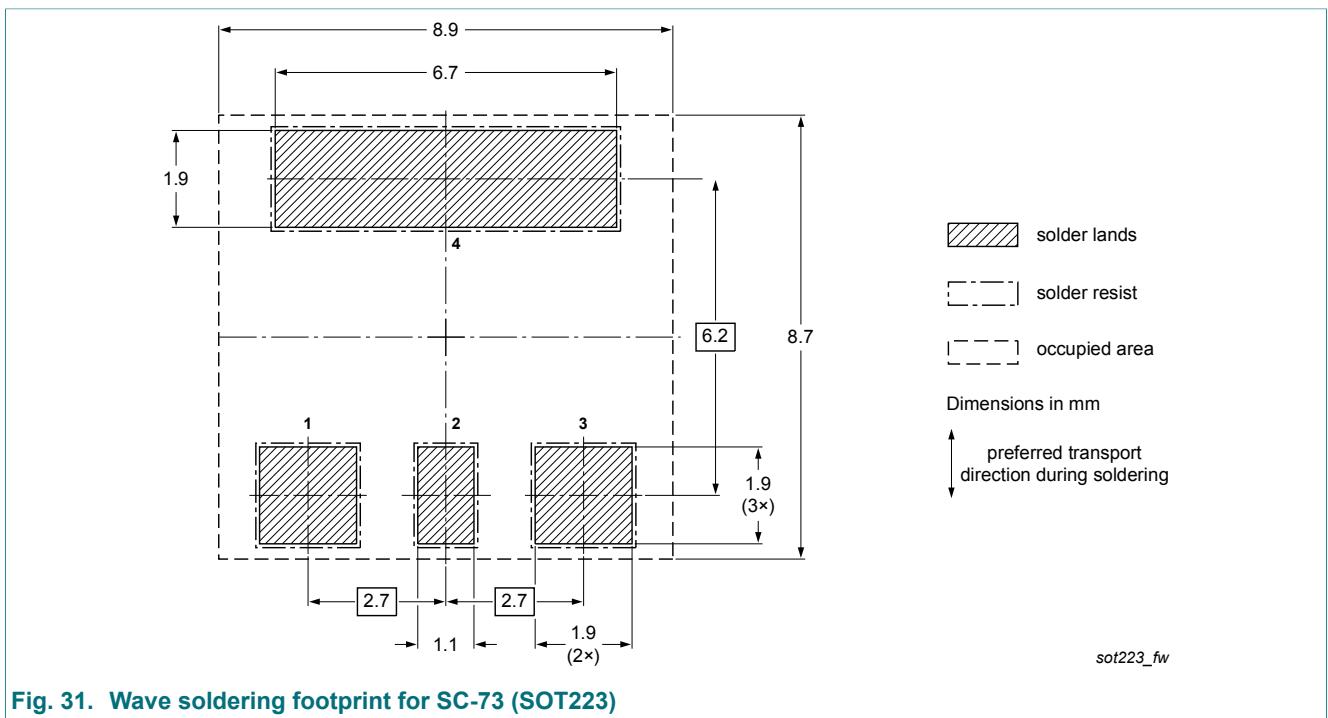

Fig. 31. Wave soldering footprint for SC-73 (SOT223)

## 11. Revision history

Table 11. Revision history

Document ID	Release date	Data sheet status	Change notice	Supersedes
NCR420Z_NCR421Z v.1	20190204	Product data sheet	-	-



## 12. Legal information

### Data sheet status

Document status [1][2]	Product status [3]	Definition
Objective [short] data sheet	Development	This document contains data from the objective specification for product development.
Preliminary [short] data sheet	Qualification	This document contains data from the preliminary specification.
Product [short] data sheet	Production	This document contains the product specification.

- [1] Please consult the most recently issued document before initiating or completing a design.
- [2] The term 'short data sheet' is explained in section "Definitions".
- [3] The product status of device(s) described in this document may have changed since this document was published and may differ in case of multiple devices. The latest product status information is available on the internet at <https://www.nexperia.com>.

### Definitions

**Draft** — The document is a draft version only. The content is still under internal review and subject to formal approval, which may result in modifications or additions. Nexperia does not give any representations or warranties as to the accuracy or completeness of information included herein and shall have no liability for the consequences of use of such information.

**Short data sheet** — A short data sheet is an extract from a full data sheet with the same product type number(s) and title. A short data sheet is intended for quick reference only and should not be relied upon to contain detailed and full information. For detailed and full information see the relevant full data sheet, which is available on request via the local Nexperia sales office. In case of any inconsistency or conflict with the short data sheet, the full data sheet shall prevail.

**Product specification** — The information and data provided in a Product data sheet shall define the specification of the product as agreed between Nexperia and its customer, unless Nexperia and customer have explicitly agreed otherwise in writing. In no event however, shall an agreement be valid in which the Nexperia product is deemed to offer functions and qualities beyond those described in the Product data sheet.

### Disclaimers

**Limited warranty and liability** — Information in this document is believed to be accurate and reliable. However, Nexperia does not give any representations or warranties, expressed or implied, as to the accuracy or completeness of such information and shall have no liability for the consequences of use of such information. Nexperia takes no responsibility for the content in this document if provided by an information source outside of Nexperia.

In no event shall Nexperia be liable for any indirect, incidental, punitive, special or consequential damages (including - without limitation - lost profits, lost savings, business interruption, costs related to the removal or replacement of any products or rework charges) whether or not such damages are based on tort (including negligence), warranty, breach of contract or any other legal theory.

Notwithstanding any damages that customer might incur for any reason whatsoever, Nexperia's aggregate and cumulative liability towards customer for the products described herein shall be limited in accordance with the Terms and conditions of commercial sale of Nexperia.

**Right to make changes** — Nexperia reserves the right to make changes to information published in this document, including without limitation specifications and product descriptions, at any time and without notice. This document supersedes and replaces all information supplied prior to the publication hereof.

**Suitability for use in automotive applications** — This Nexperia product has been qualified for use in automotive applications. Unless otherwise agreed in writing, the product is not designed, authorized or warranted to be suitable for use in life support, life-critical or safety-critical systems or

equipment, nor in applications where failure or malfunction of an Nexperia product can reasonably be expected to result in personal injury, death or severe property or environmental damage. Nexperia and its suppliers accept no liability for inclusion and/or use of Nexperia products in such equipment or applications and therefore such inclusion and/or use is at the customer's own risk.

**Quick reference data** — The Quick reference data is an extract of the product data given in the Limiting values and Characteristics sections of this document, and as such is not complete, exhaustive or legally binding.

**Applications** — Applications that are described herein for any of these products are for illustrative purposes only. Nexperia makes no representation or warranty that such applications will be suitable for the specified use without further testing or modification.

Customers are responsible for the design and operation of their applications and products using Nexperia products, and Nexperia accepts no liability for any assistance with applications or customer product design. It is customer's sole responsibility to determine whether the Nexperia product is suitable and fit for the customer's applications and products planned, as well as for the planned application and use of customer's third party customer(s). Customers should provide appropriate design and operating safeguards to minimize the risks associated with their applications and products.

Nexperia does not accept any liability related to any default, damage, costs or problem which is based on any weakness or default in the customer's applications or products, or the application or use by customer's third party customer(s). Customer is responsible for doing all necessary testing for the customer's applications and products using Nexperia products in order to avoid a default of the applications and the products or of the application or use by customer's third party customer(s). Nexperia does not accept any liability in this respect.

**Limiting values** — Stress above one or more limiting values (as defined in the Absolute Maximum Ratings System of IEC 60134) will cause permanent damage to the device. Limiting values are stress ratings only and (proper) operation of the device at these or any other conditions above those given in the Recommended operating conditions section (if present) or the Characteristics sections of this document is not warranted. Constant or repeated exposure to limiting values will permanently and irreversibly affect the quality and reliability of the device.

**Terms and conditions of commercial sale** — Nexperia products are sold subject to the general terms and conditions of commercial sale, as published at <http://www.nexperia.com/profile/terms>, unless otherwise agreed in a valid written individual agreement. In case an individual agreement is concluded only the terms and conditions of the respective agreement shall apply. Nexperia hereby expressly objects to applying the customer's general terms and conditions with regard to the purchase of Nexperia products by customer.

**No offer to sell or license** — Nothing in this document may be interpreted or construed as an offer to sell products that is open for acceptance or the grant, conveyance or implication of any license under any copyrights, patents or other industrial or intellectual property rights.

**Export control** — This document as well as the item(s) described herein may be subject to export control regulations. Export might require a prior authorization from competent authorities.

**Translations** — A non-English (translated) version of a document is for reference only. The English version shall prevail in case of any discrepancy between the translated and English versions.

### Trademarks

Notice: All referenced brands, product names, service names and trademarks are the property of their respective owners.

## Contents

---

<b>1. Product profile</b> .....	<b>1</b>
1.1. General description.....	1
1.2. Features and benefits.....	1
1.3. Applications.....	1
1.4. Quick reference data.....	2
<b>2. Pinning information</b> .....	<b>2</b>
<b>3. Ordering information</b> .....	<b>2</b>
<b>4. Marking</b> .....	<b>2</b>
<b>5. Limiting values</b> .....	<b>3</b>
<b>6. Thermal characteristics</b> .....	<b>4</b>
<b>7. Characteristics</b> .....	<b>6</b>
<b>8. Application information</b> .....	<b>12</b>
<b>9. Package outline</b> .....	<b>14</b>
<b>10. Soldering</b> .....	<b>15</b>
<b>11. Revision history</b> .....	<b>16</b>
<b>12. Legal information</b> .....	<b>17</b>

---

© Nexperia B.V. 2019. All rights reserved

For more information, please visit: <http://www.nexperia.com>

For sales office addresses, please send an email to: [salesaddresses@nexperia.com](mailto:salesaddresses@nexperia.com)

Date of release: 4 February 2019

---

Компания «Океан Электроники» предлагает заключение долгосрочных отношений при поставках импортных электронных компонентов на взаимовыгодных условиях!

Наши преимущества:

- Поставка оригинальных импортных электронных компонентов напрямую с производств Америки, Европы и Азии, а так же с крупнейших складов мира;
- Широкая линейка поставок активных и пассивных импортных электронных компонентов (более 30 млн. наименований);
- Поставка сложных, дефицитных, либо снятых с производства позиций;
- Оперативные сроки поставки под заказ (от 5 рабочих дней);
- Экспресс доставка в любую точку России;
- Помощь Конструкторского Отдела и консультации квалифицированных инженеров;
- Техническая поддержка проекта, помощь в подборе аналогов, поставка прототипов;
- Поставка электронных компонентов под контролем ВП;
- Система менеджмента качества сертифицирована по Международному стандарту ISO 9001;
- При необходимости вся продукция военного и аэрокосмического назначения проходит испытания и сертификацию в лаборатории (по согласованию с заказчиком);
- Поставка специализированных компонентов военного и аэрокосмического уровня качества (Xilinx, Altera, Analog Devices, Intersil, Interpoint, Microsemi, Actel, Aeroflex, Peregrine, VPT, Syfer, Eurofarad, Texas Instruments, MS Kennedy, Miteq, Cobham, E2V, MA-COM, Hittite, Mini-Circuits, General Dynamics и др.);

Компания «Океан Электроники» является официальным дистрибьютором и эксклюзивным представителем в России одного из крупнейших производителей разъемов военного и аэрокосмического назначения «JONHON», а так же официальным дистрибьютором и эксклюзивным представителем в России производителя высокотехнологичных и надежных решений для передачи СВЧ сигналов «FORSTAR».



## JONHON

«JONHON» (основан в 1970 г.)

Разъемы специального, военного и аэрокосмического назначения:

(Применяются в военной, авиационной, аэрокосмической, морской, железнодорожной, горно- и нефтедобывающей отраслях промышленности)

«FORSTAR» (основан в 1998 г.)

ВЧ соединители, коаксиальные кабели, кабельные сборки и микроволновые компоненты:

(Применяются в телекоммуникациях гражданского и специального назначения, в средствах связи, РЛС, а так же военной, авиационной и аэрокосмической отраслях промышленности).



Телефон: 8 (812) 309-75-97 (многоканальный)

Факс: 8 (812) 320-03-32

Электронная почта: [ocean@oceanchips.ru](mailto:ocean@oceanchips.ru)

Web: <http://oceanchips.ru/>

Адрес: 198099, г. Санкт-Петербург, ул. Калинина, д. 2, корп. 4, лит. А