

Features

- Single Stage, Single Ended
- 75 Ω or 50 Ω Operation
- 5 V, 100 mA Operation
- 15 dB Flat Gain
- Low Noise
- Low Distortion Performance
- ESD Class 1C for HBM
- Lead-Free SOT-89 Plastic Package
- Halogen-Free “Green” Mold Compound
- RoHS* Compliant

Description

The MAAM-011251 is an RF amplifier assembled in a SOT-89 plastic package. This amplifier provides 15 dB of flat gain in both forward and reverse path applications. This amplifier provides excellent noise figure.

The amplifier provides high gain, low noise and low distortion making it ideally suited for 75 Ω infrastructure applications. It can also be tuned for 50 Ω wideband applications and narrow band applications up to 6 GHz.

Ordering Information^{1,2}

Part Number	Package
MAAM-011251-TR1000	1000 piece reel
MAAM-011251-TR3000	3000 piece reel
MAAM-011251-DSBSMB	Sample Board, 45 - 1218 MHz
MAAM-011251-USBSMB	Sample Board, 5 - 300 MHz

1. Reference Application Note M513 for reel size information.
2. All production sample boards include 5 loose parts.

Functional Schematic

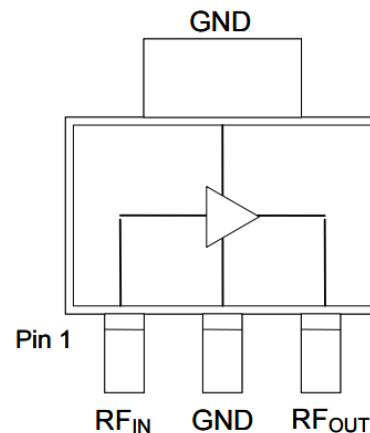

Pin Configuration

Pin #	Pin Name	Function
1	RF _{IN}	RF Input
2	GND	RF and DC Ground
3	RF _{OUT}	RF Output / V _{DD}

* Restrictions on Hazardous Substances, European Union Directive 2011/65/EU.

75 Ω , High Linearity, Low Noise, CATV Amplifier 15 dB Gain, 5 - 1218 MHz

Rev. V2

Electrical Specifications: $T_A = 25^\circ\text{C}$, $V_{DD} = 5\text{ V}$, $Z_0 = 75\ \Omega$

Parameter	Test Conditions	Units	Min.	Typ.	Max.
Gain	45 - 1218 MHz	dB	14	15	16
Tilt	45 - 1218 MHz	dB	—	0.1	—
Reverse Isolation	45 - 1218 MHz	dB	—	19	—
Input Return Loss	45 - 1218 MHz	dB	—	19	—
Output Return Loss	45 - 1218 MHz	dB	—	20	—
Noise Figure	45 MHz 1218 MHz	dB	—	1.9 2.3	2.9
Output IP2	45 - 1218 MHz, tone spacing 6 MHz, P_{OUT} per tone = 2 dBm	dBm	—	48	—
Output IP3	45 - 1218 MHz, tone spacing 6 MHz, P_{OUT} per tone = 2 dBm	dBm	—	37	—
P1dB	—	dBm	—	18	—
Composite Triple Beat, CTB	79 channels, 0 dB Tilt, 32 dBmV per channel output, QAM to 1000 MHz	dBc	—	-75	—
Composite Second Order, CSO	79 channels, 0 dB Tilt, 32 dBmV per channel output, QAM to 1000 MHz	dBc	—	-61	—
I_{DD}	$V_{DD} = 5\text{ V}$	mA	—	95	110

Absolute Maximum Ratings^{3,4,5,6}

Parameter	Absolute Maximum
Input Power	9 dBm
Operating Voltage	7 V
Operating Temperature	-40°C to +85°C
Storage Temperature	-65°C to +150°C
Junction Temperature	+150°C

- Exceeding any one or combination of these limits may cause permanent damage to this device.
- MACOM does not recommend sustained operation near these survivability limits.
- Operating at nominal conditions with $T_J \leq 150^\circ\text{C}$ will ensure $MTTF > 1 \times 10^6$ hours.
- Junction Temperature (T_J) = $T_C + \Theta_{JC} \cdot (V \cdot I)$
Typical thermal resistance (Θ_{JC}) = 44°C/W.
 - For $T_C = 25^\circ\text{C}$,
 $T_J = 47^\circ\text{C}$ @ 5 V, 100 mA
 - For $T_C = 85^\circ\text{C}$,
 $T_J = 105^\circ\text{C}$ @ 5 V, 90 mA

Handling Procedures

Please observe the following precautions to avoid damage:

Static Sensitivity

Integrated Circuits are sensitive to electrostatic discharge (ESD) and can be damaged by static electricity. Proper ESD control techniques should be used when handling these HBM Class 1C devices.

Recommended PCB Layout, 45 - 1218 MHz

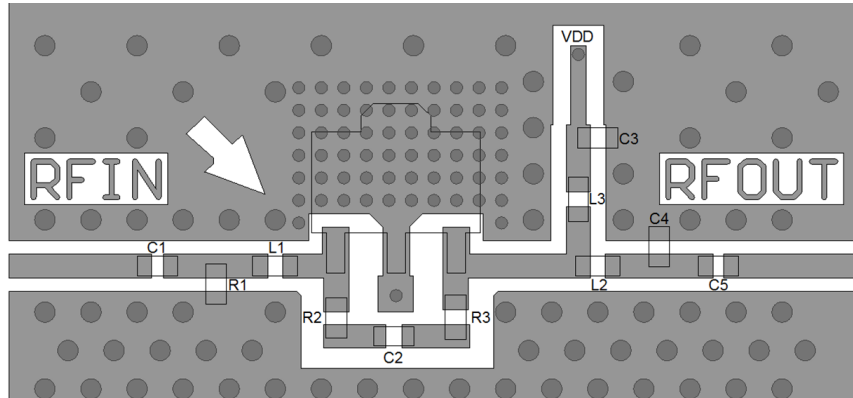

Application Schematic, 45 - 1218 MHz

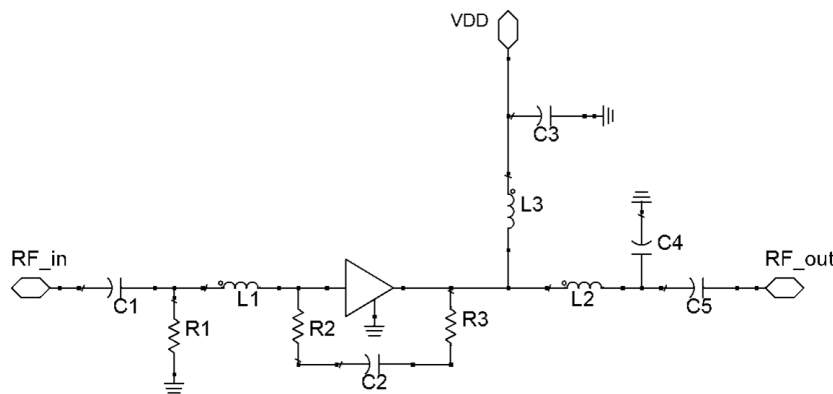

Parts List

Component	Value	Package
C1-C3	10 nF	0402
C4	0.9 pF	0402
C5	180 pF	0402
L1	6.8 nH	0402
L2	8.2 nH	0402
L3	Ferrite Bead ⁷	0402
R1	30.1 k Ω	0402
R2	240 Ω	0402
R3	330 Ω	0402

PCB Land Pattern⁸

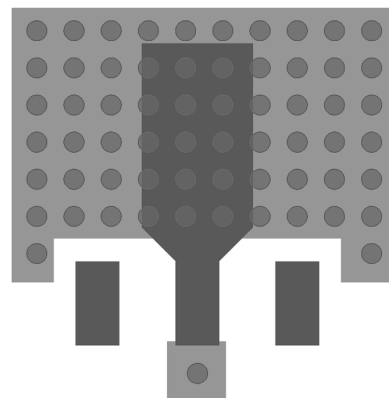

8. 60 vias beneath package, 0.012" via diameter

7. Ferrite Bead from Murata, part number BLM15HD182SN.

75 Ω , High Linearity, Low Noise, CATV Amplifier 15 dB Gain, 5 - 1218 MHz

Rev. V2

Typical Performance Curves: $V_{DD} = 5\text{ V}$, 45 - 1218 MHz Application

Gain

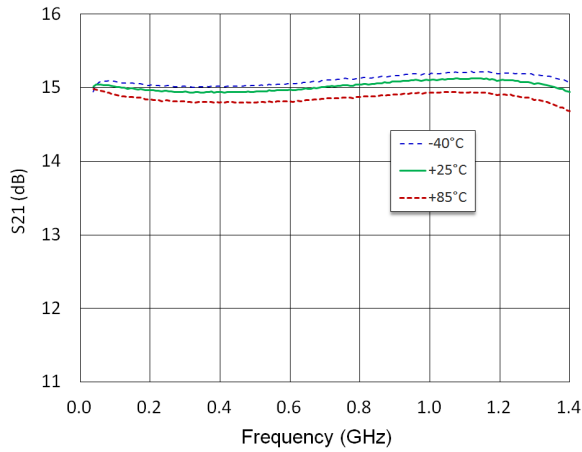

Gain to 3 GHz

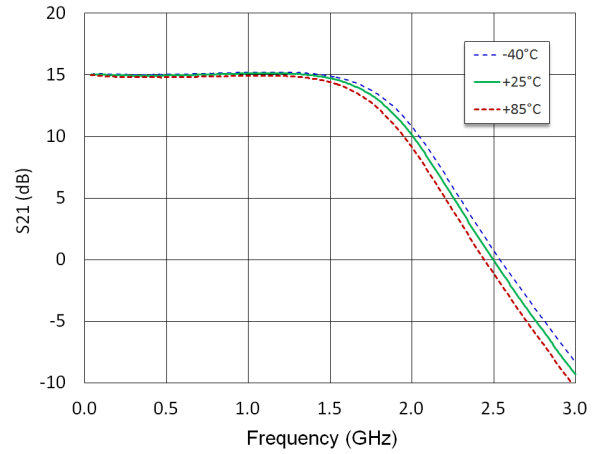

Input Return Loss

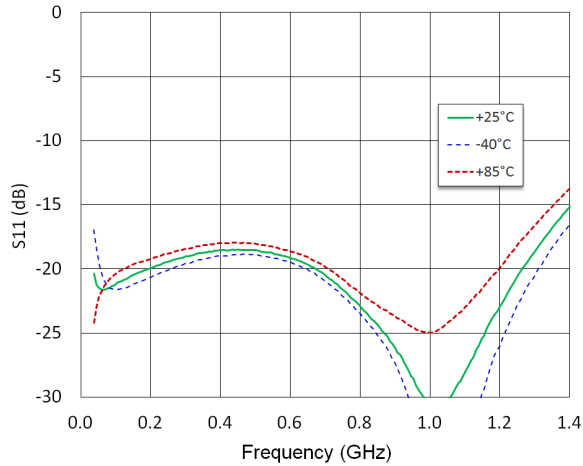

Output Return Loss

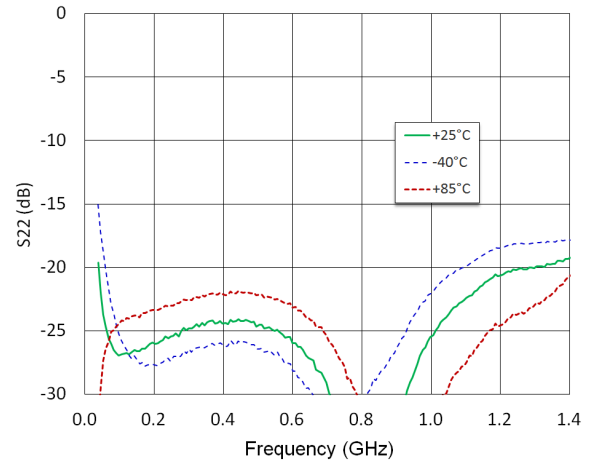

Reverse Isolation

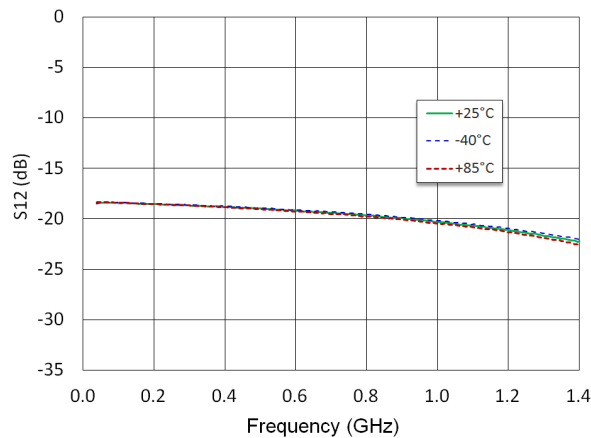

Noise Figure

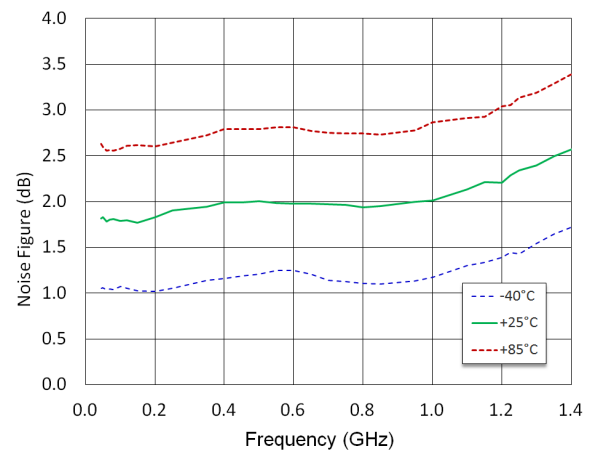

75 Ω , High Linearity, Low Noise, CATV Amplifier
15 dB Gain, 5 - 1218 MHz

Rev. V2

Typical Performance Curves: $V_{DD} = 5\text{ V}$, 45 - 1218 MHz Application

OIP3, $P_{OUT} = +2\text{ dBm/tone}$

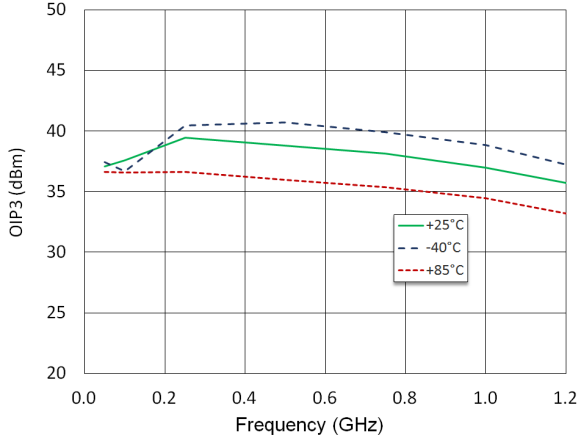

OIP2, $P_{OUT} = +2\text{ dBm/tone}$

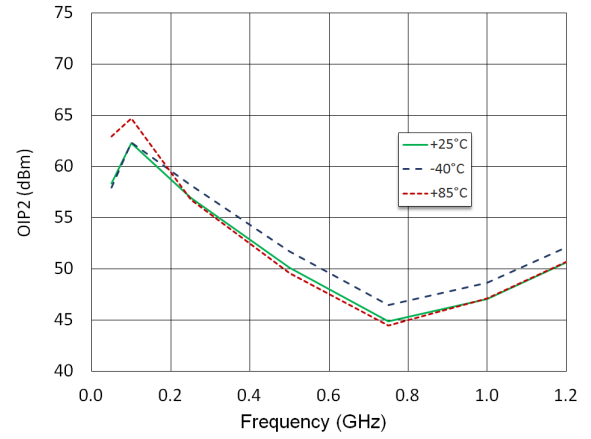

CSO Lower, 79 channels + QAM to 1 GHz, 0 dB tilt, 32 dBmV per channel

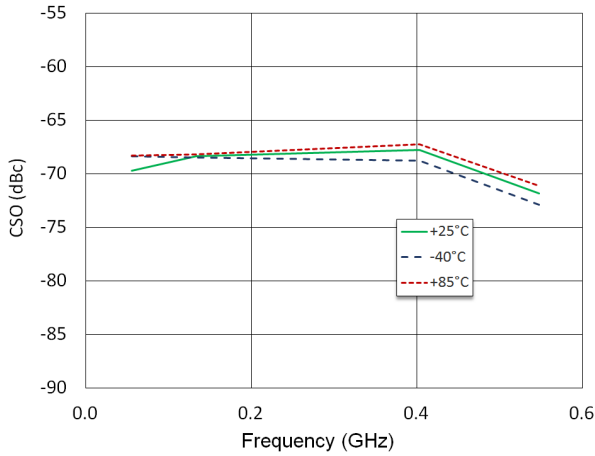

CSO Upper, 79 channels + QAM to 1 GHz, 0 dB tilt, 32 dBmV per channel

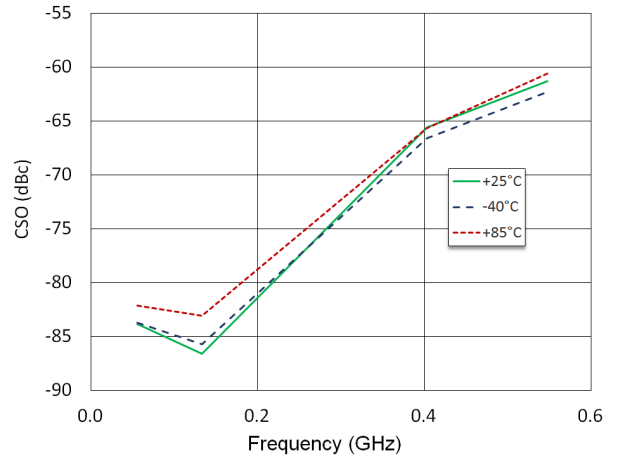

CTB, 79 channels + QAM to 1 GHz, 0 dB tilt, 32 dBmV per channel

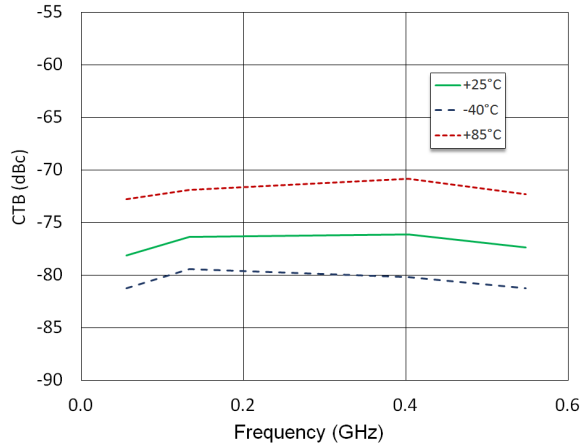

P1dB

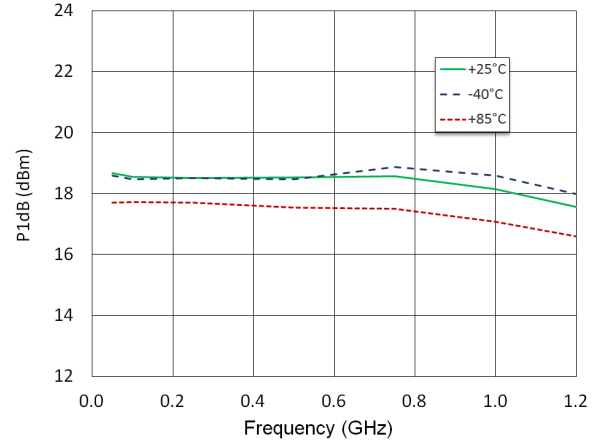

Lead Free SOT-89[†]

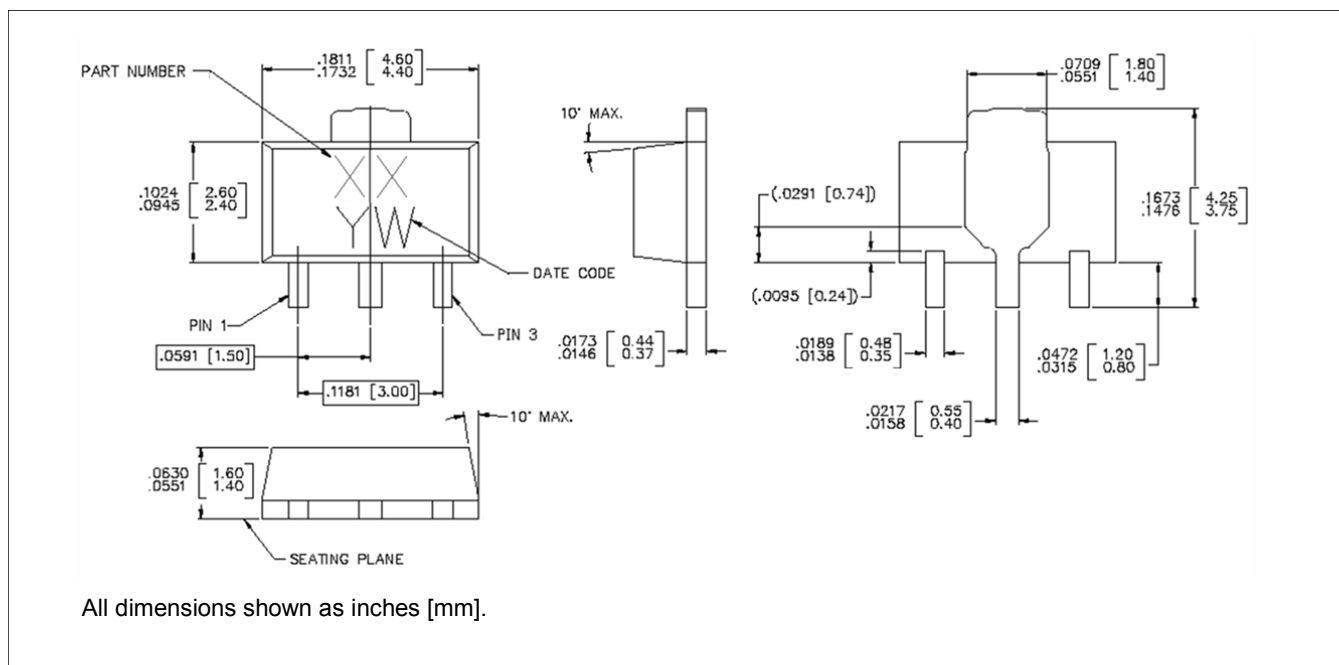

[†] Reference Application Note S2083 for lead-free solder reflow recommendations.
 Meets JEDEC moisture sensitivity level 1 requirements.
 Plating is 100% matte tin over copper.

Applications Section - 5 - 300 MHz Application

The MAAM-011251 may be tuned for operation in the 5 - 300 MHz band for CATV reverse path (upstream) applications using alternate external tuning components.

Typical Performance: $T_A = 25^\circ\text{C}$, $V_{DD} = 5\text{ V}$, $Z_0 = 75\ \Omega$

Parameter	Test Conditions	Units	Min.	Typ.	Max.
Gain	5 - 300 MHz	dB	—	14.5	—
Tilt	5 - 300 MHz	dB	—	0	—
Reverse Isolation	5 - 300 MHz	dB	—	-18	—
Input Return Loss	5 - 300 MHz	dB	—	28	—
Output Return Loss	5 - 300 MHz	dB	—	30	—
Noise Figure	10 MHz 50 - 300 MHz	dB	—	2.5 2.0	—
Output IP2	5 - 300MHz, tone spacing 6 MHz, P_{OUT} per tone = 2 dBm	dBm	—	62	—
Output IP3	5 - 300MHz, tone spacing 6 MHz, P_{OUT} per tone = 2 dBm	dBm	—	40	—
P1dB	5 - 300 MHz	dBm	—	18	—
I_{DD}	$V_{DD} = 5\text{ V}$	mA	—	95	—
Noise Power Ratio	5 - 85 MHz, 41 MHz Notch, Peak NPR 5 - 204 MHz, 100 MHz Notch, Peak NPR	dB	—	69 66	—

Recommended PCB Layout

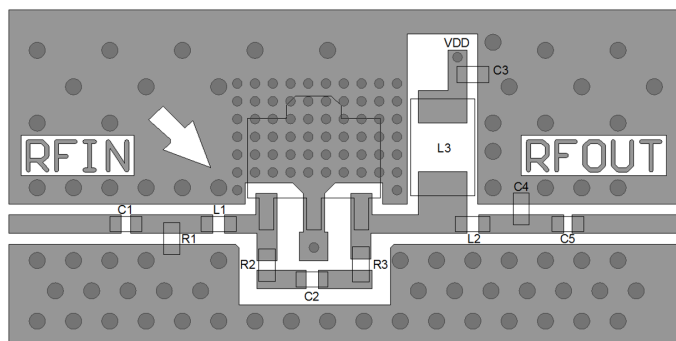

Parts List

Component	Value	Package
C1 - C3	10 nF	0402
C4	Do Not Install	—
C5	2200 pF	0402
L1	0 Ω Resistor	0402
L2	8.2 nH	0402
L3	22 μH^9	0806
R1	27 k Ω	0402
R2	240 Ω	0402
R3	270 Ω	0402

9. Inductor from Murata, part number LQH2MCN220K02

75 Ω , High Linearity, Low Noise, CATV Amplifier
15 dB Gain, 5 - 1218 MHz

Rev. V2

Typical Performance Curves: $V_{DD} = 5\text{ V}$, 5 - 300 MHz Application

Gain

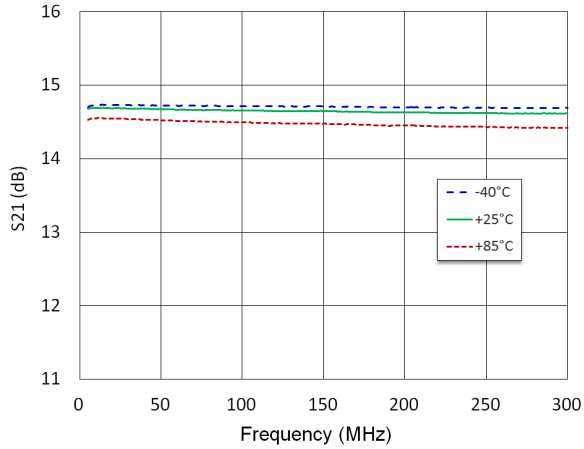

Input Return Loss

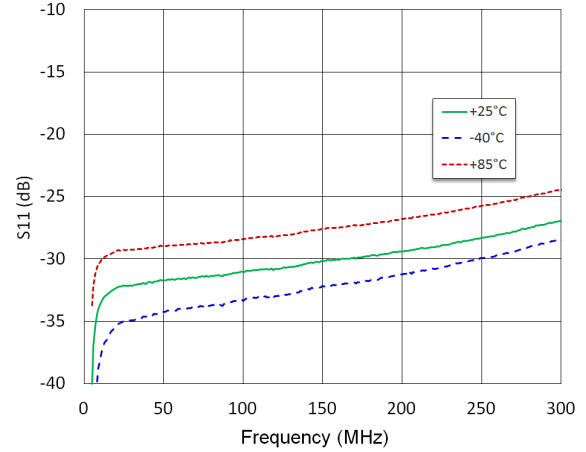

Output Return Loss

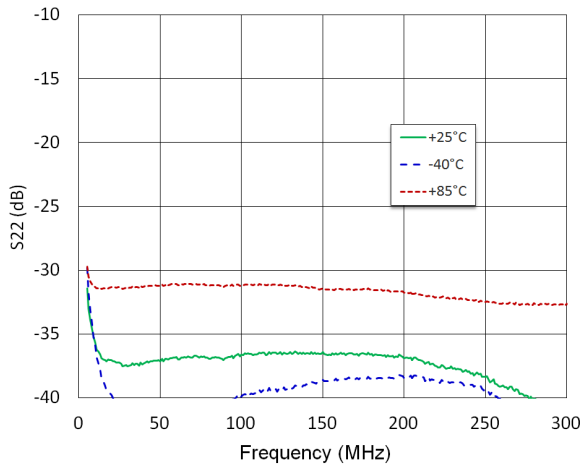

Noise Figure, 10 - 300MHz

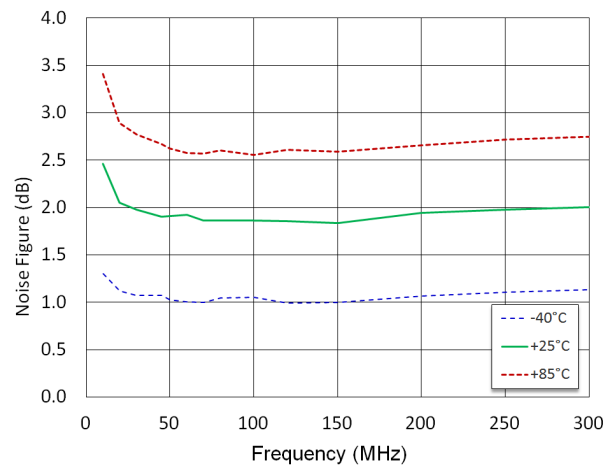

OIP3, $P_{OUT} = +2\text{ dBm/tone}$

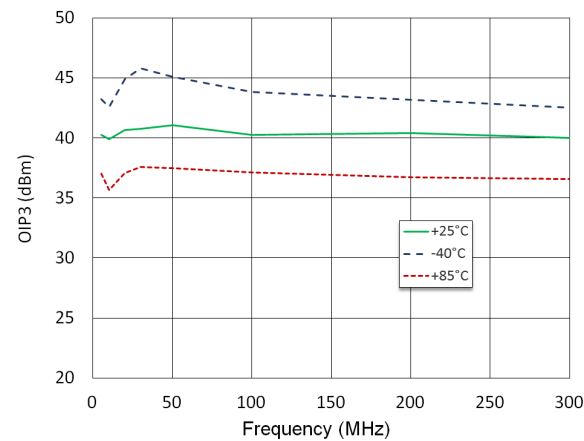

OIP2, $P_{OUT} = +2\text{ dBm/tone}$

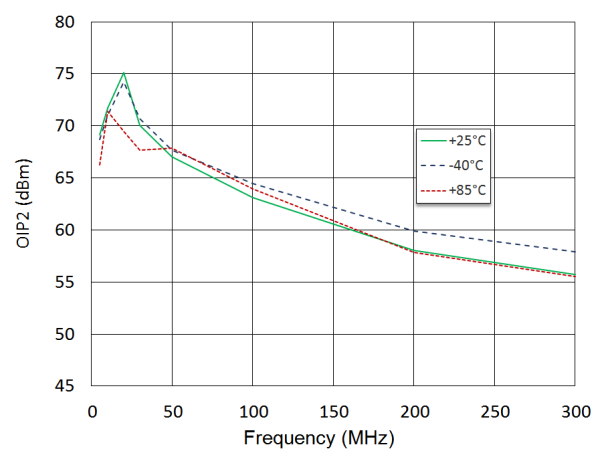

75 Ω , High Linearity, Low Noise, CATV Amplifier 15 dB Gain, 5 - 1218 MHz

Rev. V2

Typical Performance Curves: $V_{DD} = 5\text{ V}$, 5 - 300 MHz Application

NPR, 5 - 85 MHz, 41 MHz Notch

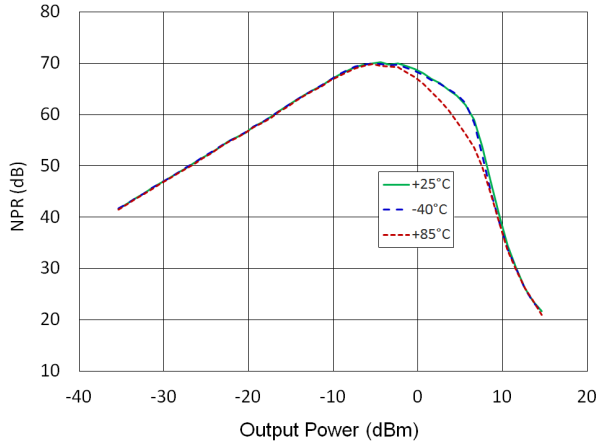

NPR, 5 - 204 MHz, 100 MHz Notch

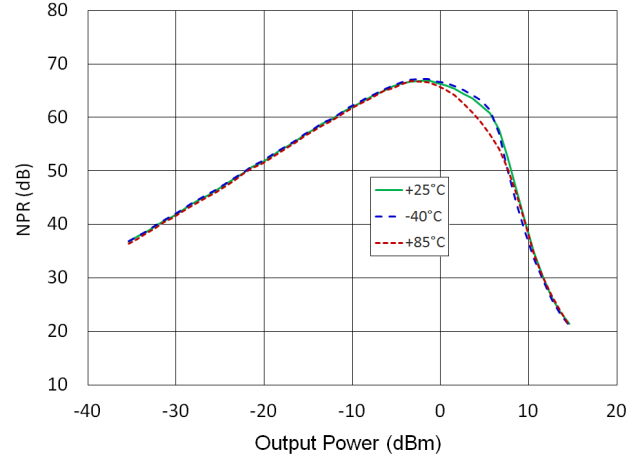

P1dB

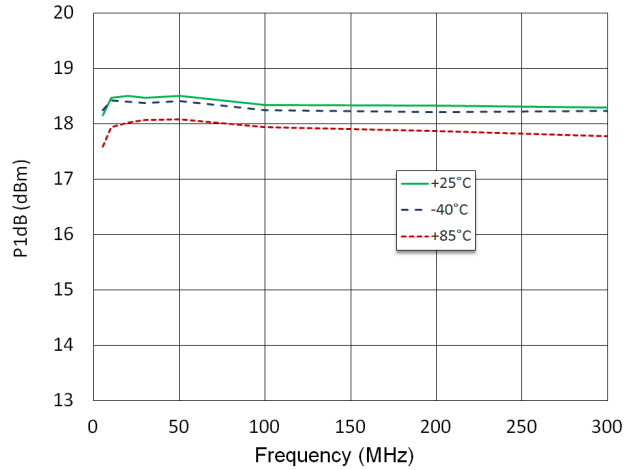

50 Ω System Application Section

The MAAM-011251 can be used for 50-ohm system by using a 50 Ω evaluation board and alternate external tuning components.

Typical Performance: $T_A = 25^\circ\text{C}$, $V_{DD} = 5\text{ V}$, 125 mA, $Z_0 = 50\ \Omega$, 45 - 2000 MHz Application

Parameter	Test Conditions	Units	Min.	Typ.	Max.
Gain	45 - 2000 MHz	dB	—	10.8	—
Gain Flatness	45 - 2000 MHz	dB	—	+/- 0.5	—
Reverse Isolation	45 - 2000 MHz	dB	—	17	—
Input Return Loss	45 - 2000 MHz	dB	—	12	—
Output Return Loss	45 - 2000 MHz	dB	—	17	—
Noise Figure	45 MHz 2000 MHz	dB	—	2.8 3.6	—
Output IP2	45 - 2000 MHz, tone spacing 6 MHz, P_{OUT} per tone = -10 dBm	dBm	—	56	—
Output IP3	45 - 2000 MHz, tone spacing 6 MHz, P_{OUT} per tone = -10 dBm	dBm	—	32	—
P1dB	45 - 2000 MHz	dBm	—	18	—
I_{DD}	$V_{DD} = 5\text{ V}$	mA	—	125	—

Recommended PCB Layout 50 Ω , 45 - 2000 MHz Application

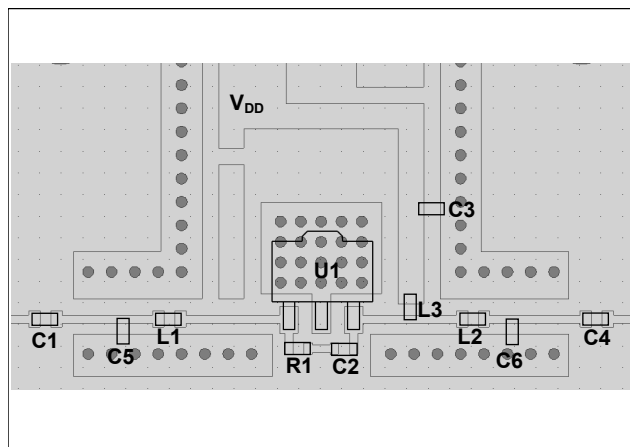

Parts List, $V_{DD} = 5\text{ V}$, 125 mA

Component	Value	Package
C1 - C3	10 nF	0402
C4	220 pF	0402
C5	Do Not Place	0402
C6	0.7 pF	0402
L1 - L2	2.2 nH	0402
L3	Ferrite Bead ¹⁰	0402
R1	270 Ω	0402

10. Murata, part number BLM15HD182SN.

75 Ω , High Linearity, Low Noise, CATV Amplifier
15 dB Gain, 5 - 1218 MHz

Rev. V2

Typical Performance Curves: $V_{DD} = 5\text{ V}$, 125 mA , $+25^\circ\text{C}$, $Z_0 = 50\ \Omega$, 45 - 2000 MHz

Gain

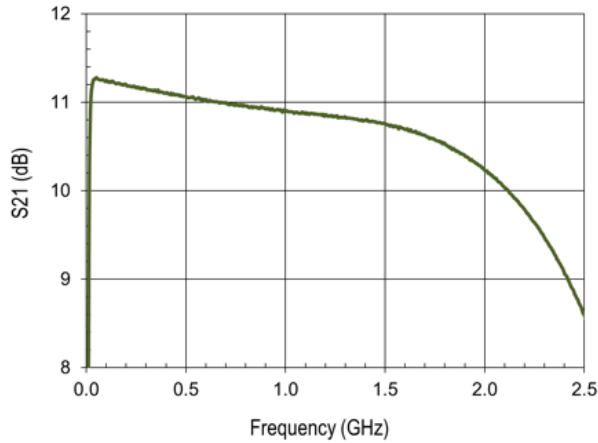

Gain to 4 GHz

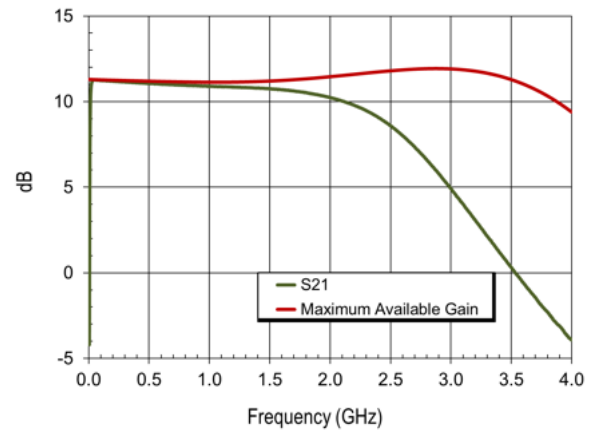

Input & Output Return Losses

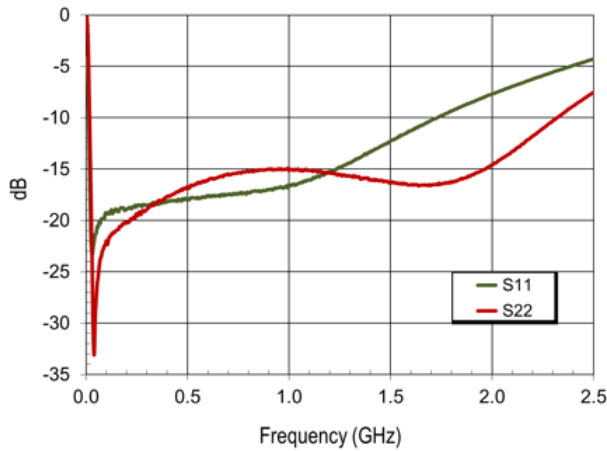

Reverse Isolation

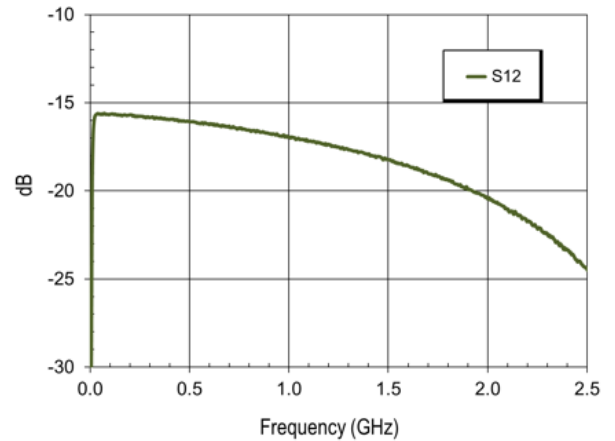

P1dB

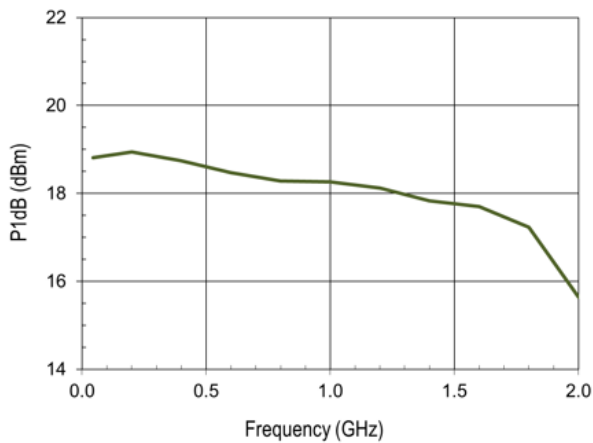

Noise Figure

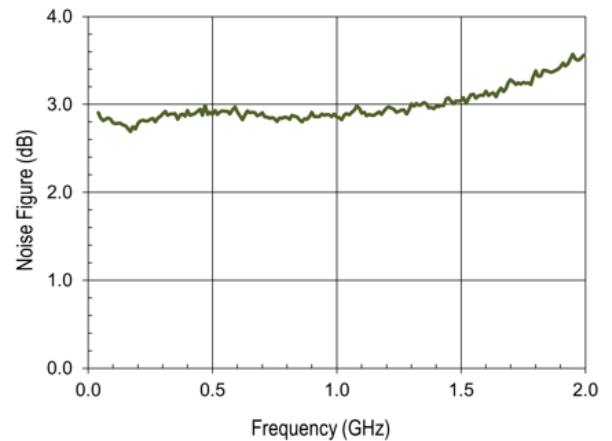

75 Ω , High Linearity, Low Noise, CATV Amplifier
15 dB Gain, 5 - 1218 MHz

Rev. V2

Typical Performance Curves: $V_{DD} = 5\text{ V}$, 125 mA , $+25^\circ\text{C}$, $Z_0 = 50\ \Omega$, 45 - 2000 MHz

OIP3, $P_{OUT} = -10\text{ dBm/tone}$

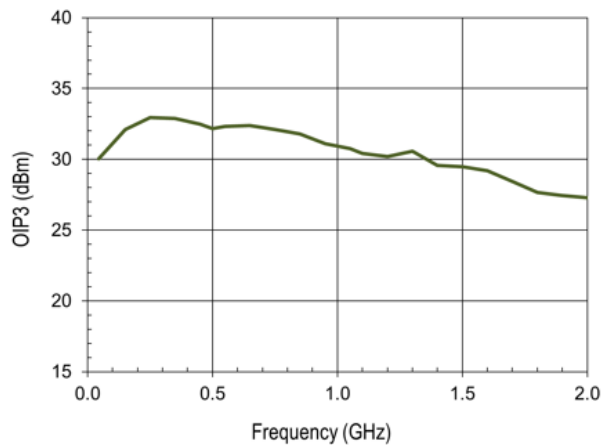

OIP2, $P_{OUT} = -10\text{ dBm/tone}$

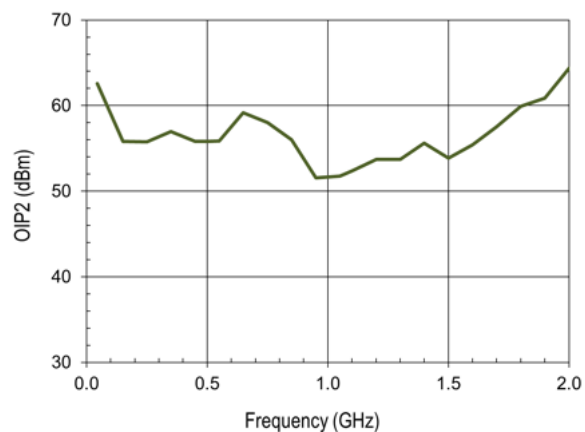

MACOM Technology Solutions Inc. All rights reserved.

Information in this document is provided in connection with MACOM Technology Solutions Inc ("MACOM") products. These materials are provided by MACOM as a service to its customers and may be used for informational purposes only. Except as provided in MACOM's Terms and Conditions of Sale for such products or in any separate agreement related to this document, MACOM assumes no liability whatsoever. MACOM assumes no responsibility for errors or omissions in these materials. MACOM may make changes to specifications and product descriptions at any time, without notice. MACOM makes no commitment to update the information and shall have no responsibility whatsoever for conflicts or incompatibilities arising from future changes to its specifications and product descriptions. No license, express or implied, by estoppel or otherwise, to any intellectual property rights is granted by this document.

THESE MATERIALS ARE PROVIDED "AS IS" WITHOUT WARRANTY OF ANY KIND, EITHER EXPRESS OR IMPLIED, RELATING TO SALE AND/OR USE OF MACOM PRODUCTS INCLUDING LIABILITY OR WARRANTIES RELATING TO FITNESS FOR A PARTICULAR PURPOSE, CONSEQUENTIAL OR INCIDENTAL DAMAGES, MERCHANTABILITY, OR INFRINGEMENT OF ANY PATENT, COPYRIGHT OR OTHER INTELLECTUAL PROPERTY RIGHT. MACOM FURTHER DOES NOT WARRANT THE ACCURACY OR COMPLETENESS OF THE INFORMATION, TEXT, GRAPHICS OR OTHER ITEMS CONTAINED WITHIN THESE MATERIALS. MACOM SHALL NOT BE LIABLE FOR ANY SPECIAL, INDIRECT, INCIDENTAL, OR CONSEQUENTIAL DAMAGES, INCLUDING WITHOUT LIMITATION, LOST REVENUES OR LOST PROFITS, WHICH MAY RESULT FROM THE USE OF THESE MATERIALS.

MACOM products are not intended for use in medical, lifesaving or life sustaining applications. MACOM customers using or selling MACOM products for use in such applications do so at their own risk and agree to fully indemnify MACOM for any damages resulting from such improper use or sale.

Компания «Океан Электроники» предлагает заключение долгосрочных отношений при поставках импортных электронных компонентов на взаимовыгодных условиях!

Наши преимущества:

- Поставка оригинальных импортных электронных компонентов напрямую с производств Америки, Европы и Азии, а так же с крупнейших складов мира;
- Широкая линейка поставок активных и пассивных импортных электронных компонентов (более 30 млн. наименований);
- Поставка сложных, дефицитных, либо снятых с производства позиций;
- Оперативные сроки поставки под заказ (от 5 рабочих дней);
- Экспресс доставка в любую точку России;
- Помощь Конструкторского Отдела и консультации квалифицированных инженеров;
- Техническая поддержка проекта, помощь в подборе аналогов, поставка прототипов;
- Поставка электронных компонентов под контролем ВП;
- Система менеджмента качества сертифицирована по Международному стандарту ISO 9001;
- При необходимости вся продукция военного и аэрокосмического назначения проходит испытания и сертификацию в лаборатории (по согласованию с заказчиком);
- Поставка специализированных компонентов военного и аэрокосмического уровня качества (Xilinx, Altera, Analog Devices, Intersil, Interpoint, Microsemi, Actel, Aeroflex, Peregrine, VPT, Syfer, Eurofarad, Texas Instruments, MS Kennedy, Miteq, Cobham, E2V, MA-COM, Hittite, Mini-Circuits, General Dynamics и др.);

Компания «Океан Электроники» является официальным дистрибьютором и эксклюзивным представителем в России одного из крупнейших производителей разъемов военного и аэрокосмического назначения «JONHON», а так же официальным дистрибьютором и эксклюзивным представителем в России производителя высокотехнологичных и надежных решений для передачи СВЧ сигналов «FORSTAR».



JONHON

«JONHON» (основан в 1970 г.)

Разъемы специального, военного и аэрокосмического назначения:

(Применяются в военной, авиационной, аэрокосмической, морской, железнодорожной, горно- и нефтедобывающей отраслях промышленности)

«FORSTAR» (основан в 1998 г.)

ВЧ соединители, коаксиальные кабели, кабельные сборки и микроволновые компоненты:

(Применяются в телекоммуникациях гражданского и специального назначения, в средствах связи, РЛС, а так же военной, авиационной и аэрокосмической отраслях промышленности).



Телефон: 8 (812) 309-75-97 (многоканальный)

Факс: 8 (812) 320-03-32

Электронная почта: ocean@oceanchips.ru

Web: <http://oceanchips.ru/>

Адрес: 198099, г. Санкт-Петербург, ул. Калинина, д. 2, корп. 4, лит. А