

NOVA22



DR22 Series

AC Output DIN Rail Mount SSRs

- Output ratings up to 35 Amps at 600 VAC
- Built-in overvoltage protection
- Relay or Contactor configuration
- Integral heat sink eliminates the need for complex thermal calculations
- DBC substrate for superior thermal performance
- "Elevator" screw option to allow the use of ring or lug type terminals
- IP20 touch-safe housing
- AC or DC control
- C-UL-US and TUV approved

PRODUCT SELECTION

Control Voltage	20A	30A	35A
90-280 VAC/VDC	DR2260A20x	DR2260A30x	DR2260A35x
4-32 VDC	DR2260D20x	DR2260D30x	DR2260D35x

AVAILABLE OPTIONS

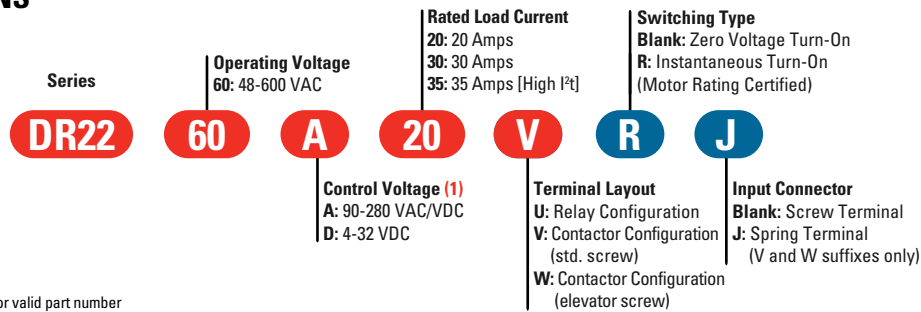

- Required for valid part number
- For options only and not required for valid part number

OUTPUT SPECIFICATIONS (2)

Description	20A	30A	35A
Operating Voltage (47-440Hz) [V _{RMS}]	48-600	48-600	48-600
Transient Overvoltage [V _{pk}] (3)	1200	1200	1200
Maximum Off-State Leakage Current @ Rated Voltage [mA _{RMS}]	1	1	1
Minimum Off-State dV/dt @ Maximum Rated Voltage [V/μsec]	500	500	500
Load Current, General Use UL508/LC A IEC62314 @ 40°C [A _{RMS}]	20	30	35
Load Current, Motor Starting UL508 FLA/LC B IEC62314 @ 40°C [A _{RMS}]	8.5/4.8	14/7.6	26/14
Minimum Load Current [mA _{RMS}]	100	100	150
Maximum 1 Cycle Surge Current (50/60Hz) [A _{pk}]	286/300	716/750	1290/1350
Maximum On-State Voltage Drop @ Rated Current [V _{pk}]	1.35	1.35	1.3
Maximum 1/2 Cycle I ² t for Fusing (50/60Hz) [A ² sec]	409/375	2563/2343	8320/7593
Minimum Power Factor (at Maximum Load) (4)	0.5	0.5	0.5
Motor Rating UL 508/IEC62314 [HP (kW)]: 120 VAC	0.5 (0.37)	1 (0.74)	2 (1.5)
Motor Rating UL 508/IEC62314 [HP (kW)]: 240 VAC	1.5 (1.1)	3 (2.2)	5 (3.73)
Motor Rating UL 508/IEC62314 [HP (kW)]: 480 VAC	3 (2.24)	5 (3.7)	10 (7.4)

INPUT SPECIFICATIONS (2)

Description	DR2260Dxxx	DR2260Axxx
Control Voltage Range	4-32 VDC (5)	90-280 VAC/VDC (6)
Maximum Reverse Voltage	-32 VDC	-
Minimum Turn-On Voltage	4 VDC	90 VAC/VDC
Must Turn-Off Voltage	1 VDC	5 VAC/VDC
Minimum Input Current (for on-state)	7 mA	6 mA
Maximum Input Current	15 mA	10 mA
Nominal Input Impedance	Current Limited	Current Limited
Maximum Turn-On Time [msec]	1/2 Cycle (7)	20
Maximum Turn-Off Time [msec]	1/2 Cycle	30

GENERAL SPECIFICATIONS (2)

Description	Parameters
Dielectric Strength, Input to Output (50/60Hz)	4000 V _{RMS}
Dielectric Strength, Input/Output to Case (50/60Hz)	4000 V _{RMS}
Minimum Insulation Resistance (@ 500 VDC)	10 ⁹ Ohms
Maximum Capacitance, Input/Output	8 pF
Ambient Operating Temperature Range (8)	-40 to 80 °C
Ambient Storage Temperature Range	-40 to 100 °C
Short Circuit Current Rating (9)	100kA
Weight (typical)	Option "U" 10.5 oz (298 g), Option "V", "W" 10.6 oz (301 g)
Housing Material	UL94 V-0
Heat Sink Material	Aluminum
Din Rail Clip Material	Zink Plated Steel
Hardware Finish	Nickel Plating
Input Terminal Screw Torque Range (lb-in/Nm)	Option "U" 13-15/1.5-1.7, Option "V", "W" 5/0.5 (10)
Load Terminal Screw Torque Range (lb-in/Nm)	Option "U" 13-15/1.5-1.7, Option "V", "W" 18-20/2-2.2
Humidity	95% non-condensing
LED Input Status Indicator	Green

INPUT CURRENT INFORMATION

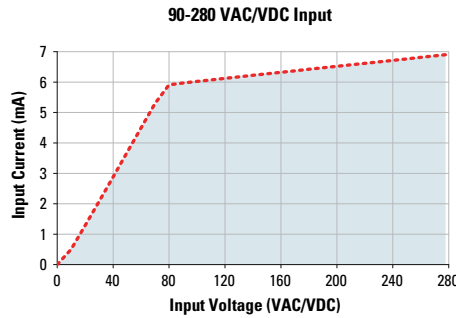
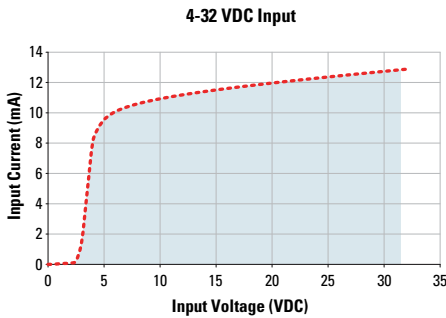

SURGE CURRENT INFORMATION

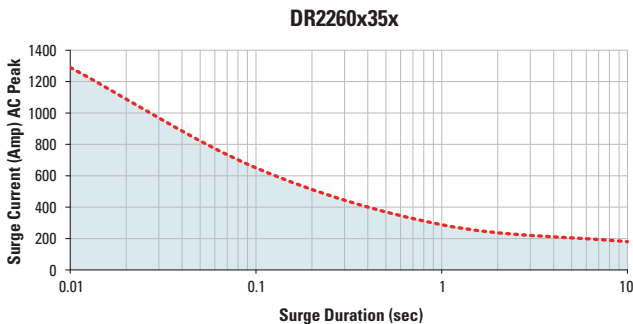
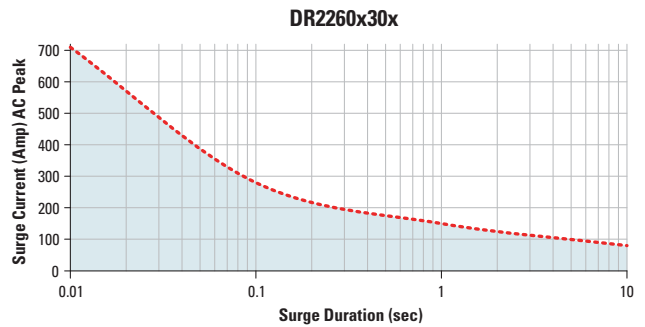
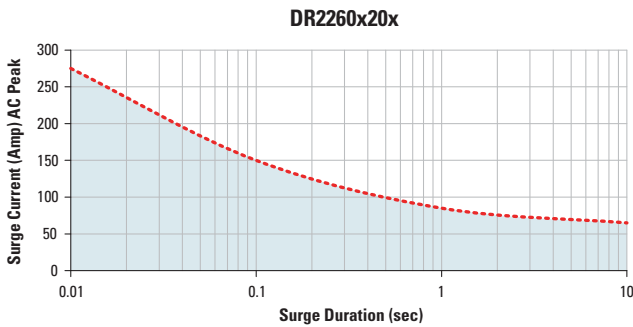

--- Single Pulse (11)

THERMAL DERATE INFORMATION (8)

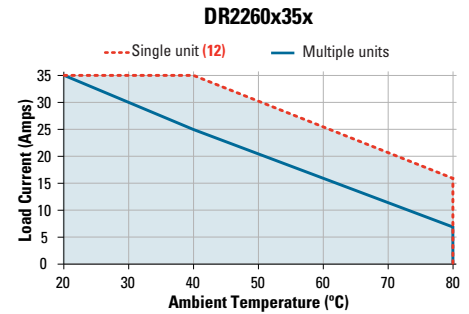
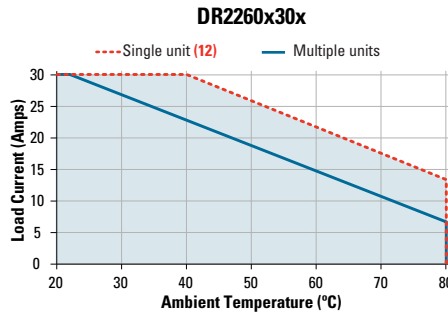
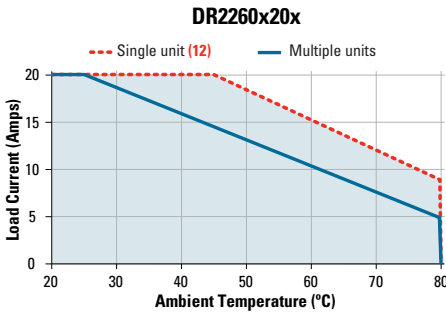

EQUIVALENT CIRCUIT BLOCK DIAGRAMS/WIRING DIAGRAM

DC Control

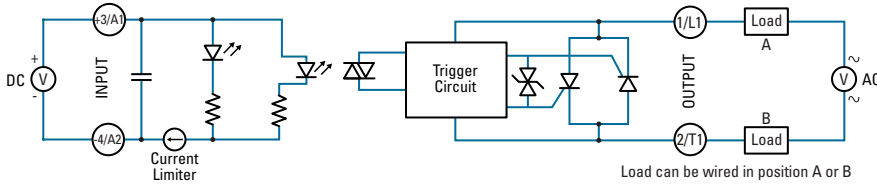

AC/DC Control

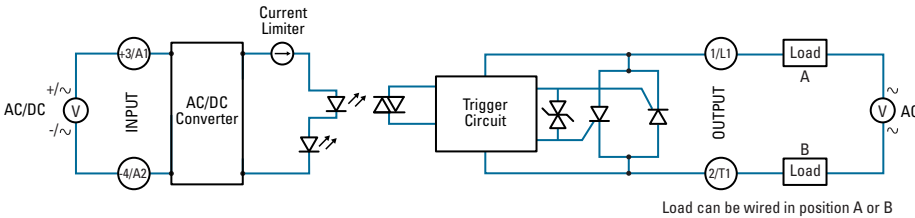

Recommended Wire Sizes

Terminal Configuration	Wire Size (Solid / Stranded)	Wire Pull-Out Strength (Ib)[N]	
Output (13) Relay "U" suffix	2 x 18 AWG (1 mm ²) Stranded	20 [88]	
	2 x 10 AWG (6 mm ²) Stranded	60 [266]	
Input Relay "U" suffix	2 x 18 AWG (1 mm ²) Stranded	20 [88]	
	2 x 12 AWG (4 mm ²) Stranded	40 [177]	
Output Contactor "V" & "W" suffixes	2 x 20 AWG (0.75 mm ²) [minimum]	25 [111]	
	2 x 10 AWG (6 mm ²)	80 [355]	
	2 x 8 AWG (10 mm ²) [maximum]	90 [400]	
Input Contactor "V" & "W" suffixes	30 AWG (0.05 mm ²) [minimum]	4.5 [20]	
	12 AWG (3.3 mm ²) [maximum]	30 [133]	
	Screw	26 AWG (0.13 mm ²) [minimum]	4 [18]
		12 AWG (3.3 mm ²) [maximum]	30 [133]

MECHANICAL SPECIFICATIONS

Tolerances: ±0.02 in / 0.5 mm
All dimensions are in: inches [millimeters]

Contactor Configuration

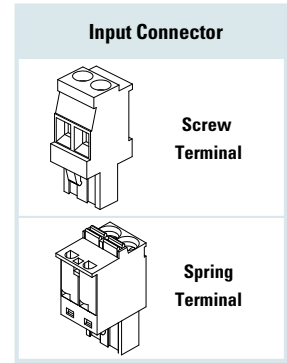
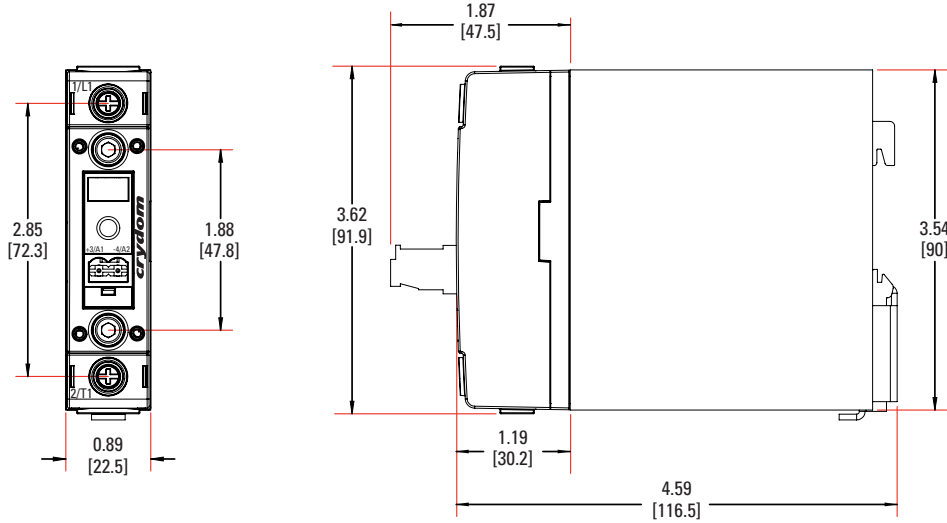

Relay Configuration

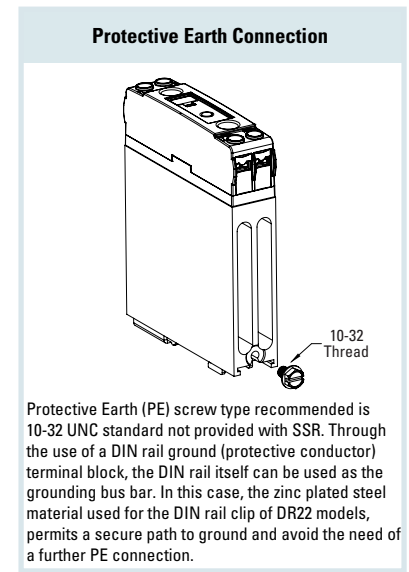
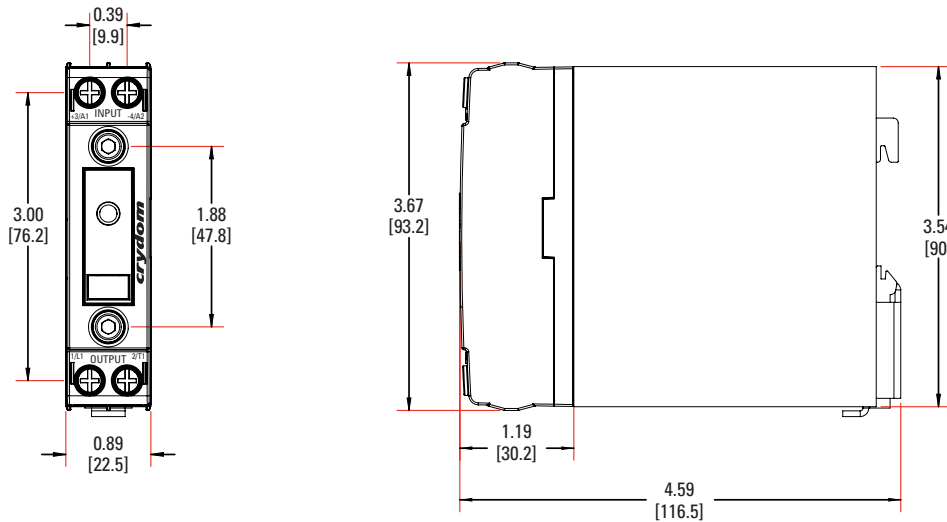
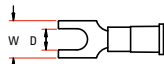

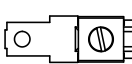
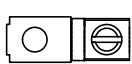
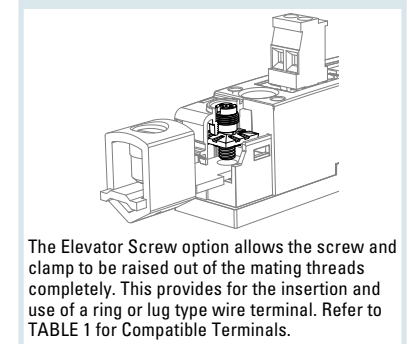

TABLE 1. Compatible Terminals

				
Terminals	Fork Lug	Ring Lug	Copper Lug	Copper Lug
Crydom Part No.			TRM0	TRM6
Width [W] in (mm)	0.45 (11.4)	0.45 (11.4)		
Stud Size Dia [D] (in)	#8 (0.168)	#8 (0.168)		
Wire Size AWG			6-0	14-6

Elevator Screw (Suffix 'W')



ACCESSORIES

Recommended Accessories		
Connectors	ID Marker	Lug Terminal
CP201	CNLB	TRM0
CP202	CNLN	TRM6
	CNL2	

New Accessories!

Connectors

Part number: CP201, CP202



Pluggable input connectors, 2 position, with screw terminals (CP201) or spring type terminals (CP202). Compatible with Contactor Configuration NOVA22 SSRs.

Lug Terminal

Part number: TRM0



Copper wire lug for AWG 6 (13.3 mm²) to AWG 0 (53.5 mm²) wire size. For use with "Elevator" screw option ("W" suffix) NOVA22 SSRs.

AGENCY APPROVALS, CONFORMANCES AND EMC



Certification in accordance with:

United States Standard for Industrial Control Equipment - UL 508 and Canadian Standard Association for Industrial Control Equipment – C22.2 No. 14.

TUV Certified in accordance to EN62314

Vibration Resistance: **(15)**
IEC 60068-2-6: Amplitude Range 10-500 Hz, Displacement 0.75mm

Shock Resistance: **(15)**
IEC 60068-2-27: Peak Acceleration 50g, Duration 11ms.

Electromagnetic Compatibility

Generic Standard	Immunity Tests	Test Specification Level		Performance
IEC 61000-6-2 Immunity for Industrial Environments	Electrostatic Discharge IEC 61000-4-2	8kV air discharge		Criterion B
		6kV contact discharge		Criterion A
	Fast transients (burst) IEC 61000-4-4	Output	2kV, 5kHz, 100kHz	Criterion B
		Input	1kV, 5kHz, 100kHz	Criterion B
	Surge IEC 61000-4-5	Output	1kV Line to Line	Criterion B
			2kV Line to Earth	Criterion B
		AC Input	1kV Line to Line	Criterion B
			Option 2kV Line to Earth	Criterion B

GENERAL NOTES

- (1) Control voltage 18-52 VAC/VDC is available upon request.
- (2) All parameters at 25°C unless otherwise specified.
- (3) Output will self trigger between 900-1200 Vpk, not suitable for capacitive loads.
- (4) High inductive loads requires nominal control voltage; AC input models only.
- (5) Increase minimum voltage by 1 V for operations from -20 to -40°C.
- (6) For ambient temperatures above 40°C the maximum control voltage must not exceed 250 VAC/VDC.
- (7) Turn-on time for Instantaneous turn-on versions is 0.1 msec.
- (8) AC input models operating range is -20 to 60 °C.
- (9) When protected with the appropriate class and rated fuse. For detailed info please contact Crydom Technical Support.
- (10) Input torque only for contactor (V,W) with screw terminals Connector.
- (11) For single surge pulse T_c=25°C; T_j=125°C. For AC Output SSRs, AC RMS value of surge current equals the peak value divided by $\sqrt{2}$ (1.414).
- (12) Minimum spacing to obtain max. current is 22.5mm between adjacent units.
- (13) For 35 Amp Relay ("U") layout models, use Pin Terminals (L 0.410 in x Ø 0.102 in) to install 8 AWG wire.
- (14) Applicable to Relay ("U") option.
- (15) Test made with a unit fixed between DIN RAIL Stoppers. Multiple devices mounted close each other, results may vary.

⚠ DANGER / PELIGRO / DANGER /GEFAHR / PERICOLO / 危險

<p>HAZARD OF ELECTRIC SHOCK, EXPLOSION, OR ARC FLASH.</p> <ul style="list-style-type: none"> • Disconnect all power before installing or working with this equipment. • Verify all connections and replace all covers before turning on power. <p>Failure to follow these instructions will result in death or serious injury.</p>	<p>RIESGO DE DESCARGA ELECTRICA O EXPLOSION.</p> <ul style="list-style-type: none"> • Desconectar todos los suministros de energia a este equipo antes de trabajar con este equipo. • Verificar todas las conexiones y colocar todas las tapas antes de energizar el equipo. <p>El incumplimiento de estas instrucciones puede provocar la muerte o lesiones serias.</p>	<p>RISQUE DE DESCARGE ELECTRIQUE OU EXPLOSION</p> <ul style="list-style-type: none"> • Eteindre toutes les sources d'énergie de cet appareil avant de travailler dessus de cet appareil • Vérifier tous connections, et remettre tous couverts en place avant de mettre sous <p>De non-suivi de ces instructions provoquera la mort ou des lésions sérieuses.</p>	<p>GEFAHR EINES ELEKTRISCHE N SCHLAGES ODER EINER EXPLOSION.</p> <ul style="list-style-type: none"> • Stellen Sie jeglichen Strom ab, der dieses Gerät versorgt, bevor Sie an dem Gerät Arbeiten durchführen • Vor dem Drehen auf Energie alle Anschlüsse überprüfen und alle Abdeckungen ersetzen. <p>Unterlassung dieser Anweisungen können zum Tode oder zu schweren Verletzungen führen.</p>	<p>RISCHIO DI SCOSSA ELETTRICA O DELL'ESPLOSIONE.</p> <ul style="list-style-type: none"> • Spenga tutta l'alimentazione che fornisce questa apparecchiatura prima di lavorare a questa apparecchiatura • Verificare tutti i collegamenti e sostituire tutte le coperture prima dell'accensione <p>L'omissione di queste istruzioni provocherà la morte o lesioni serie</p>	<p>存在电击、爆炸或电弧闪烁危险</p> <ul style="list-style-type: none"> • 在操作此设备之前请先关闭电源。 <p>若不遵守这些说明,可能会导致严重的人身伤害甚至死亡。</p>
--	--	---	--	--	---

⚠ WARNING / AVERTISSEMENT / WARNUNG /ADVERTENCIA / AVVERTENZA / 警告

<p>RISK OF MATERIAL DAMAGE AND HOT ENCLOSURE</p> <ul style="list-style-type: none"> • The product's side panels may be hot, allow the product to cool before touching. • Follow proper mounting instructions including torque values. • Do not allow liquids or foreign objects to enter this product. <p>Failure to follow these instructions can result in serious injury, or equipment damage.</p>	<p>RISQUE DE DOMMAGE MATERIEL ET DE SURCHAUFFE DU BOITIER</p> <ul style="list-style-type: none"> • Les panneaux latéraux du produit peuvent être chauds. Laisser le produit refroidir avant de le toucher. • Respecter les consignes de montage, et notamment les couples de serrage. • Ne pas laisser pénétrer de liquide ni de corps étrangers à l'intérieur du produit. <p>Le non-respect de cette directive peut entraîner, des lésions corporelles graves ou des dommages matériels.</p>	<p>GEFAHR VON MATERIALSCHÄDEN UND GEHÄUSEERHITZUNG</p> <ul style="list-style-type: none"> • Die Seitenwände können heiß sein. Lassen Sie das Produkt abkühlen, bevor Sie es berühren. • Beachten Sie die Montageanweisungen, • Führen Sie keine Flüssigkeiten oder Fremdkörper in das Produkt ein. <p>Die Nichtbeachtung dieser Anweisung kann Körperverletzung oder Materialschäden zur Folge haben.</p>
<p>RIESGO DE DAÑOS MATERIALES Y DE SOBRECIENTAMIENTO DE LA UNIDAD</p> <ul style="list-style-type: none"> • Los paneles laterales del producto pueden estar calientes. Esperar que el producto se enfríe antes de tocarlo. • Respetar las instrucciones de montaje, y en particular los pares de apretado. • No dejar que penetren líquidos o cuerpos extraños en el producto. <p>Si no se respetan estas precauciones pueden producirse graves lesiones, daños materiales.</p>	<p>RISCHIO DI DANNI MATERIALI E D'INVOLUCRO CALDO</p> <ul style="list-style-type: none"> • I pannelli laterali dell'apparecchio possono scottare; lasciar quindi raffreddare il prodotto prima di toccarlo. • Seguire le istruzioni di montaggio corrette. • Non far entrare liquidi o oggetti estranei in questo apparecchio. <p>La mancata osservanza di questa precauzione può causare gravi rischi per l'incolumità personale o danni alle apparecchiature.</p>	<p>材料损坏和高温外壳的危险性</p> <ul style="list-style-type: none"> • 产品的一侧面板可能很热, 在其冷却前请不要触碰。 • 遵照正确的安装说明, 包括扭矩值。 • 请勿让液体及其他异物进入本产品。 <p>如不能正确执行这些操作说明, 极有可能造成严重人体伤害或者设备的损坏。</p>

ANNEX - ENVIRONMENTAL INFORMATION

The environmental information disclosed in this annex including the EIP Pollution logo are in compliance with People’s Republic of China Electronic Industry Standard SJ/T11364 – 2006, Marking for Control of Pollution Caused by Electronic Information Products.

Part Name	Toxic or hazardous Substance and Elements					
	Lead (Pb)	Mercury (Hg)	Cadmium (Cd)	Hexavalent Chromium (Cr (VI))	Polybrominated biphenyls (PBB)	Polybrominated diphenyl ethers (PBDE)
Semiconductor die	X	○	○	○	○	○
Solder	X	○	○	○	○	○

附件 - 环保信息

此附件所标示的包括电子信息产品污染图标的环保信息符合中华人民共和国电子行业标准 SJ/T11364 - 2006, 电子信息产品污染控制标识要求。

部件名称	有毒有害物质或元素					
	铅 (Pb)	汞 (Hg)	镉 (Cd)	六价铬 (Cr (VI))	多溴联苯 (PBB)	多溴二苯醚 (PBDE)
半导体芯片	X	○	○	○	○	○
焊接点	X	○	○	○	○	○



Компания «Океан Электроники» предлагает заключение долгосрочных отношений при поставках импортных электронных компонентов на взаимовыгодных условиях!

Наши преимущества:

- Поставка оригинальных импортных электронных компонентов напрямую с производств Америки, Европы и Азии, а так же с крупнейших складов мира;
- Широкая линейка поставок активных и пассивных импортных электронных компонентов (более 30 млн. наименований);
- Поставка сложных, дефицитных, либо снятых с производства позиций;
- Оперативные сроки поставки под заказ (от 5 рабочих дней);
- Экспресс доставка в любую точку России;
- Помощь Конструкторского Отдела и консультации квалифицированных инженеров;
- Техническая поддержка проекта, помощь в подборе аналогов, поставка прототипов;
- Поставка электронных компонентов под контролем ВП;
- Система менеджмента качества сертифицирована по Международному стандарту ISO 9001;
- При необходимости вся продукция военного и аэрокосмического назначения проходит испытания и сертификацию в лаборатории (по согласованию с заказчиком);
- Поставка специализированных компонентов военного и аэрокосмического уровня качества (Xilinx, Altera, Analog Devices, Intersil, Interpoint, Microsemi, Actel, Aeroflex, Peregrine, VPT, Syfer, Eurofarad, Texas Instruments, MS Kennedy, Miteq, Cobham, E2V, MA-COM, Hittite, Mini-Circuits, General Dynamics и др.);

Компания «Океан Электроники» является официальным дистрибьютором и эксклюзивным представителем в России одного из крупнейших производителей разъемов военного и аэрокосмического назначения «JONHON», а так же официальным дистрибьютором и эксклюзивным представителем в России производителя высокотехнологичных и надежных решений для передачи СВЧ сигналов «FORSTAR».



JONHON

«JONHON» (основан в 1970 г.)

Разъемы специального, военного и аэрокосмического назначения:

(Применяются в военной, авиационной, аэрокосмической, морской, железнодорожной, горно- и нефтедобывающей отраслях промышленности)

«FORSTAR» (основан в 1998 г.)

ВЧ соединители, коаксиальные кабели, кабельные сборки и микроволновые компоненты:

(Применяются в телекоммуникациях гражданского и специального назначения, в средствах связи, РЛС, а так же военной, авиационной и аэрокосмической отраслях промышленности).



Телефон: 8 (812) 309-75-97 (многоканальный)

Факс: 8 (812) 320-03-32

Электронная почта: ocean@oceanchips.ru

Web: <http://oceanchips.ru/>

Адрес: 198099, г. Санкт-Петербург, ул. Калинина, д. 2, корп. 4, лит. А