

# APPROVAL SHEET

## MULTILAYER CERAMIC CAPACITORS

High Q / Low ESR Series (HH)

0402, 0603 & 0805 Sizes

NP0 Dielectric

RoHS Compliance

\*Contents in this sheet are subject to change without prior notice.

## 1. INTRODUCTION

MLCC consists of a conducting material and electrodes. To manufacture a chip-type SMT and achieve miniaturization, high density and high efficiency, ceramic condensers are used.

WTC HH series MLCC is used at high frequencies generally have a small temperature coefficient of capacitance, typical within the  $\pm 30\text{ppm}/^\circ\text{C}$  required for NP0 (COG) classification and have excellent conductivity internal electrode. Thus, WTC HH series MLCC will be with the feature of low ESR and high Q characteristics.

## 2. FEATURES

- High Q and low ESR performance at high frequency.
- Quality improvement of telephone calls for low power loss and better performance.

## 3. APPLICATIONS

- Mobile telecommunication: Mobile phone, WLAN.
- RF module: Power amplifier, VCO.
- Tuners.

## 4. HOW TO ORDER

<u>HH</u>	<u>15</u>	<u>N</u>	<u>100</u>	<u>G</u>	<u>500</u>	<u>C</u>	<u>I</u>
<u>Series</u>	<u>Size</u>	<u>Dielectric</u>	<u>Capacitance</u>	<u>Tolerance</u>	<u>Rated voltage</u>	<u>Termination</u>	<u>Packaging</u>
HH=High Q/ Low ESR	15=0402 (1005) 18=0603 (1608) 21=0805 (2012)	N=NP0 (COG)	Two significant digits followed by no. of zeros. And R is in place of decimal point.  eg.: R47=0.47pF 0R5=0.5pF 1R0=1.0pF 100=10x10 <sup>0</sup> =10pF	B=±0.1pF C=±0.25pF D=±0.5pF F=±1% G=±2% J=±5%	Two significant digits followed by no. of zeros. And R is in place of decimal point.  160=16 VDC 250=25 VDC 500=50 VDC 101=100 VDC 201=200 VDC 251=250 VDC 501=500 VDC 631=630 VDC	L=Ag/Ni/Sn C=Cu/Ni/Sn	T=7" reeled G=13" reeled

## 5. EXTERNAL DIMENSIONS

Size Inch (mm)	L (mm)	W (mm)	T (mm)/Symbol	Remark	M <sub>B</sub> (mm)
0402 (1005)	1.00±0.05	0.50±0.05	0.50±0.05	N #	0.25 +0.05/-0.10
0603 (1608)	1.60±0.10	0.80±0.10	0.80±0.07	S	0.40±0.15
	1.60 +0.15/-0.10	0.80 +0.15/-0.10	0.80 +0.15/-0.10	X	
0805 (2012)	2.00±0.15	1.25±0.10	0.60±0.10	A	0.50±0.20
			0.80±0.10	B	
			1.25±0.10	D #	

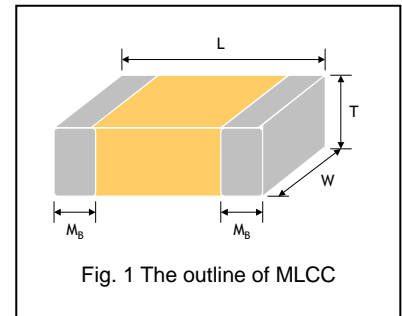

# Reflow soldering only is recommended.

## 6. GENERAL ELECTRICAL DATA

<b>Dielectric</b>	NP0
<b>Size</b>	0402, 0603, 0805
<b>Capacitance*</b>	0402: 0.5pF to 470pF** 0603: 0.5pF to 3300pF 0805: 0.5pF to 390pF
<b>Capacitance tolerance</b>	Cap≤5pF: B (±0.1pF), C (±0.25pF) 5pF<Cap<10pF: C (±0.25pF), D (±0.5pF) Cap≥10pF: F (±1%), G (±2%), J (±5%)
<b>Rated voltage (WVDC)</b>	16V, 25V, 50V, 100V, 200V, 250V, 500V, 630V
<b>Q*</b>	Cap<30pF: Q≥400+20C Cap≥30pF: Q≥1000
<b>Insulation resistance at U<sub>r</sub></b>	≥10GΩ or R <sub>x</sub> C≥100Ω·F whichever is smaller.
<b>Operating temperature</b>	-55 to +125°C
<b>Capacitance change</b>	±30ppm
<b>Termination</b>	Ni/Sn (lead-free termination)

\* Measured at the conditions of 25°C ambient temperature and 30~70% related humidity.

Apply 1.0±0.2V<sub>rms</sub>, 1.0MHz±10% for Cap≤1000pF and 1.0±0.2V<sub>rms</sub>, 1.0kHz±10% for Cap>1000pF.

\*\* 0402, Capacitance <0.5pF: On request.

## 7. CAPACITANCE RANGE

DIELECTRIC		NP0												
SIZE		0402			0603				0805					
Rated Voltage		16	25	50	16	25	50	100	50	100	200	250	500	630
Capacitance	0.5pF (0R5)	N^	N^	N^	S^	S^	S^	S^	B	B				
	0.6pF (0R6)	N^	N^	N^	S^	S^	S^	S^	B	B				
	0.7pF (0R7)	N^	N^	N^	S^	S^	S^	S^	B	B				
	0.8pF (0R8)	N^	N^	N^	S^	S^	S^	S^	B	B				
	0.9pF (0R9)	N^	N^	N^	S^	S^	S^	S^	B	B				
	1.0pF (1R0)	N^	N^	N^	S^	S^	S^	S^	B	B	B	B	B	B
	1.2pF (1R2)	N^	N^	N^	S^	S^	S^	S^	B	B	B	B	B	B
	1.5pF (1R5)	N^	N^	N^	S^	S^	S^	S^	B	B	B	B	B	B
	1.8pF (1R8)	N^	N^	N^	S^	S^	S^	S^	B	B	B	B	B	B
	2.2pF (2R2)	N^	N^	N^	S^	S^	S^	S^	B	B	B	B	B	B
	2.7pF (2R7)	N^	N^	N^	S^	S^	S^	S^	B	B	B	B	B	B
	3.3pF (3R3)	N^	N^	N^	S^	S^	S^	S^	B	B	B	B	B	B
	3.9pF (3R9)	N^	N^	N^	S^	S^	S^	S^	B	B	B	B	B	B
	4.7pF (4R7)	N^	N^	N^	S^	S^	S^	S^	B	B	B	B	B	B
	5.6pF (5R6)	N^	N^	N^	S^	S^	S^	S^	B	B	B	B	B	B
	6.8pF (6R8)	N^	N^	N^	S^	S^	S^	S^	B	B	B	B	B	B
	8.2pF (8R2)	N^	N^	N^	S^	S^	S^	S^	B	B	B	B	B	B
	10pF (100)	N	N	N	S	S	S	S	B	B	B	B	B	B
	12pF (120)	N	N	N	S	S	S	S	B	B	B	B	B	B
	15pF (150)	N	N	N	S	S	S	S	B	B	B	B	B	B
	18pF (180)	N	N	N	S	S	S	S	B	B	B	B	B	B
	22pF (220)	N	N	N	S	S	S	S	B	B	B	B	B	B
	27pF (270)	N	N	N	S	S	S	S	B	B	B	B	B	B
	33pF (330)	N	N	N	S	S	S	S	B	B	B	B	B	B
	39pF (390)	N	N	N	S	S	S	S	B	B	B	B	B	B
	47pF (470)	N	N	N	S	S	S	S	B	B	B	B	B	B
	56pF (560)	N	N	N	S	S	S	S	B	B	B	B	B	B
	68pF (680)	N	N	N	S	S	S	S	B	B	B	B	B	B
	82pF (820)	N	N	N	S	S	S	S	B	B	B	B	B	B
	100pF (101)	N	N	N	S	S	S	S	B	B	B	B	B	B
	120pF (121)	N	N	N	S	S	S	S	D	D	D	D	D	D
	150pF (151)	N	N	N	S	S	S	S	D	D	D	D	D	D
	180pF (181)	N	N	N	S	S	S	S			D	D	D	D
220pF (221)	N	N	N	S	S	S	S			D	D	D	D	
270pF (271)	N	N	N	S	S	S	S			D	D	D	D	
330pF (331)	N	N	N	S	S	S	S			D	D	D	D	
390pF (391)	N	N	N	S	S	S	S			D	D	D	D	
470pF (471)	N	N	N	S	S	S	S							
560pF (561)				S	S	S	S							
680pF (681)				S	S	S	S							
820pF (821)				S	S	S	S							
1,000pF (102)				S	S	S	S							
1,200pF (122)				X	X	X								
1,500pF (152)				X	X	X								
1,800pF (182)				X	X	X								
2,200pF (222)				X	X	X								
2,700pF (272)				X	X	X								
3,300pF (332)				X	X	X								

1. The letter in cell is expressed the symbol of product thickness.
2. The letter in cell with "N^" mark is expressed product with Ag/Ni/Sn terminations.
3. 0402, Capacitance <0.5pF: On request.
4. For more information about products with special capacitance or other data, please contact WTC local representative.

## 8. PACKAGING DIMENSION AND QUANTITY

Size	Thickness (mm)/Symbol		Paper tape		Plastic tape	
			7" reel	13" reel	7" reel	13" reel
0402	0.50±0.05	N	10K	50K		
0603	0.80±0.07	S	4K	15K		
	0.80 +0.15/-0.10	X				
0805	0.60±0.10	A	4k	15k		
	0.80±0.10	B				
	1.25±0.10	D			3k	10k

Unit: pieces

## 9. ELECTRICAL CHARACTERISTICS

### Q factor specification vs. Specific frequency

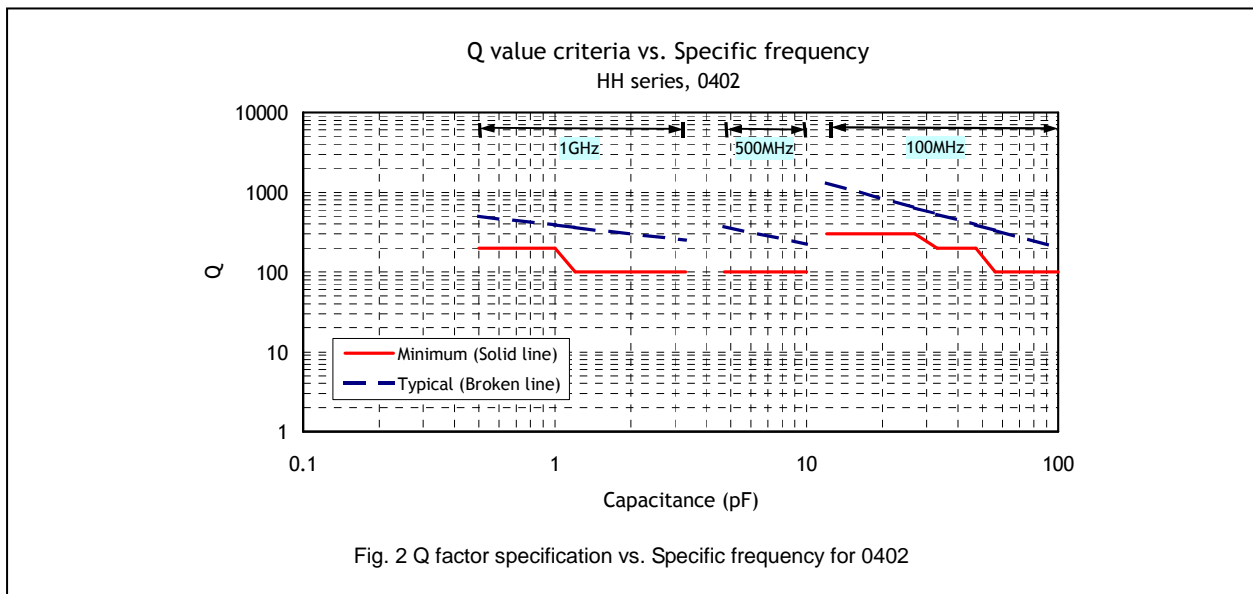

Fig. 2 Q factor specification vs. Specific frequency for 0402

### Q factor specification vs. Specific frequency

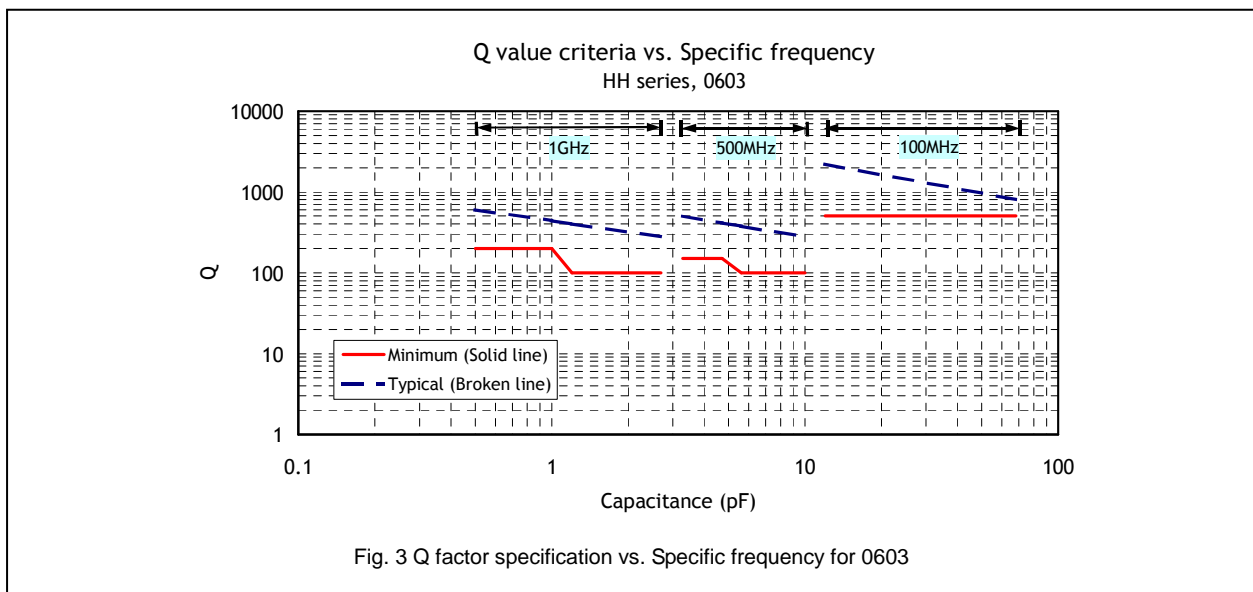
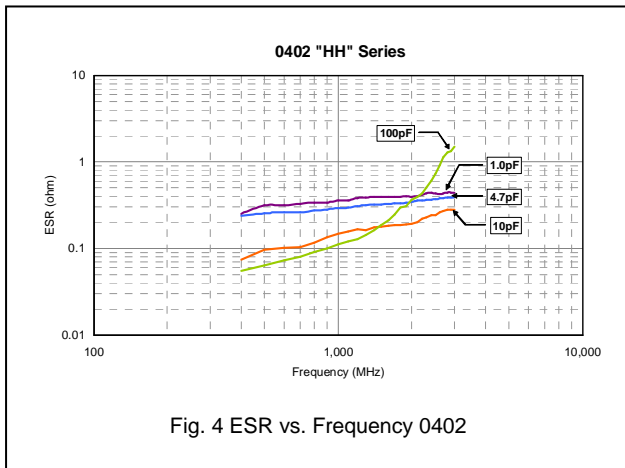
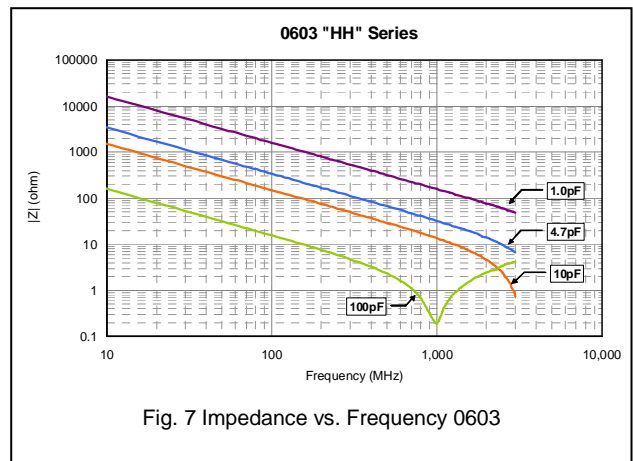
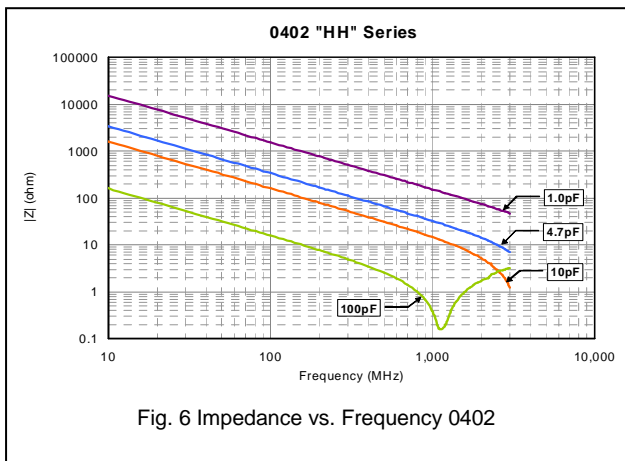

Fig. 3 Q factor specification vs. Specific frequency for 0603

Typical ESR vs. Frequency



Typical Impedance vs. Frequency



SRF vs. Capacitance

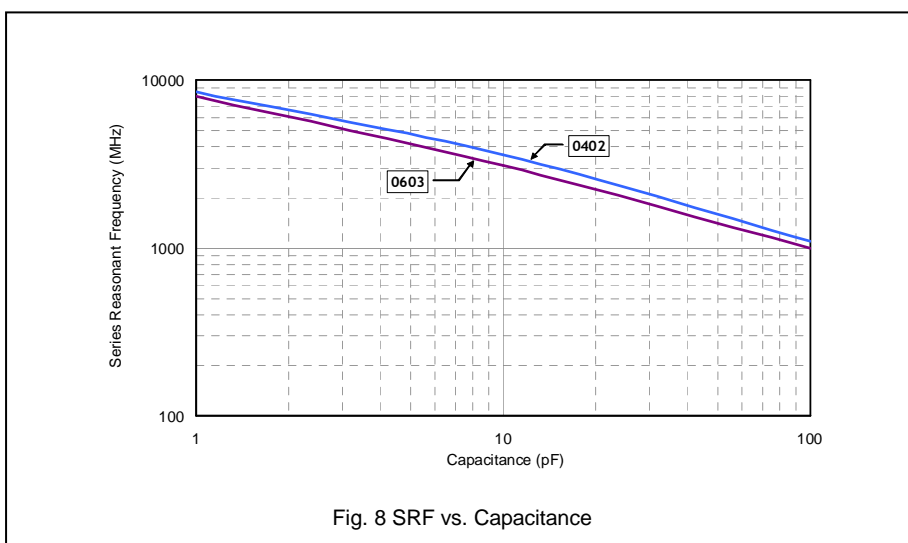

## 10. RELIABILITY TEST CONDITIONS AND REQUIREMENTS

No.	Item	Test Conditions	Requirements
1.	Visual and Mechanical	---	No remarkable defect. Dimensions to conform to individual specification sheet.
2.	Capacitance	Cap≤1000pF, 1.0±0.2Vrms, 1MHz±10%	Shall not exceed the limits given in the detailed spec.
3.	Q/ D.F. (Dissipation Factor)	Cap>1000pF, 1.0±0.2Vrms, 1KHz±10% At 25°C ambient temperature.	NP0: Cap≥30pF, Q≥1000; Cap<30pF, Q≥400+20C
4.	Dielectric Strength	<ul style="list-style-type: none"> <li>* To apply voltage: ( ≤100V ) 250% of rated voltage.</li> <li>* Duration: 1 to 5 sec.</li> <li>* Charge and discharge current less than 50mA.</li> </ul> <hr/> <ul style="list-style-type: none"> <li>* To apply voltage:</li> <li>200V~300V            ≥2 times VDC</li> <li>500V~999V           ≥1.5 times VDC</li> <li>* Cut-off, set at 10mA</li> <li>* TEST= 15 sec.</li> <li>* RAMP=0</li> </ul>	* No evidence of damage or flash over during test.
5.	Insulation Resistance	Rated voltage:<200V To apply rated voltage for max. 120 sec. <hr/> Rated voltage:200~630V To apply rated voltage (500V max.) for 60 sec.	≥10GΩ <hr/> ≥10GΩ or RxC≥100Ω-F whichever is smaller
6.	Temperature Coefficient	With no electrical load. Operating temperature: -55~125°C at 25°C	Capacitance change: within ±30ppm/°C
7.	Adhesive Strength of Termination	* Pressurizing force : 5N (≤0603) and 10N (>0603) * Test time: 10±1 sec.	No remarkable damage or removal of the terminations.
8.	Vibration Resistance	* Vibration frequency: 10~55 Hz/min. * Total amplitude: 1.5mm * Test time: 6 hrs. (Two hrs each in three mutually perpendicular directions.) * Measurement to be made after keeping at room temp. for 24±2 hrs.	* No remarkable damage. * Cap change and Q/D.F.: To meet initial spec.
9.	Solderability	* Solder temperature: 235±5°C * Dipping time: 2±0.5 sec.	95% min. coverage of all metalized area.
10.	Bending Test	* The middle part of substrate shall be pressurized by means of the pressurizing rod at a rate of about 1 mm per second until the deflection becomes 1 mm and then the pressure shall be maintained for 5±1 sec. * Measurement to be made after keeping at room temp. for 24±2 hrs.	* No remarkable damage. * Cap change: within ±5.0% or ±0.5pF whichever is larger. (This capacitance change means the change of capacitance under specified flexure of substrate from the capacitance measured before the test.)
11.	Resistance to Soldering Heat	* Solder temperature: 260±5°C * Dipping time: 10±1 sec * Preheating: 120 to 150°C for 1 minute before immerse the capacitor in a eutectic solder. * Before initial measurement (Class II only): Perform 150+0/-10°C for 1 hr and then set for 24±2 hrs at room temp. * Measurement to be made after keeping at room temp. for 24±2 hrs.	* No remarkable damage. * Cap change: within ±2.5% or ±0.25pF whichever is larger. * Q/D.F., I.R. and dielectric strength: To meet initial requirements. * 25% max. leaching on each edge.

No.	Item	Test Condition	Requirements															
12.	Temperature Cycle	<p>Conduct the five cycles according to the temperatures and time.</p> <table border="1"> <thead> <tr> <th>Step</th> <th>Temp. (°C)</th> <th>Time (min.)</th> </tr> </thead> <tbody> <tr> <td>1</td> <td>Min. operating temp. +0/-3</td> <td>30±3</td> </tr> <tr> <td>2</td> <td>Room temp.</td> <td>2-3</td> </tr> <tr> <td>3</td> <td>Max. operating temp. +3/-0</td> <td>30±3</td> </tr> <tr> <td>4</td> <td>Room temp.</td> <td>2-3</td> </tr> </tbody> </table> <p>* Before initial measurement (Class II only): Perform 150+0/-10°C for 1 hr and then set for 24±2 hrs at room temp. * Measurement to be made after keeping at room temp. for 24±2 hrs.</p>	Step	Temp. (°C)	Time (min.)	1	Min. operating temp. +0/-3	30±3	2	Room temp.	2-3	3	Max. operating temp. +3/-0	30±3	4	Room temp.	2-3	<p>No remarkable damage. Cap change : within ±2.5% or ±0.25pF whichever is larger. * Q/D.F., I.R. and dielectric strength: To meet initial requirements.</p>
Step	Temp. (°C)	Time (min.)																
1	Min. operating temp. +0/-3	30±3																
2	Room temp.	2-3																
3	Max. operating temp. +3/-0	30±3																
4	Room temp.	2-3																
13.	Humidity (Damp Heat) Steady State	<p>* Test temp.: 40±2°C * Humidity: 90~95% RH * Test time: 500+24/-0hrs. * Before initial measurement (Class II only): Perform 150+0/-10°C for 1 hr and then set for 24±2 hrs at room temp. * Measurement to be made after keeping at room temp. for 24±2 hrs.</p>	<p>* No remarkable damage. * Cap change: within ±5.0% or ±0.5pF whichever is larger. * Q/D.F. value: NP0: Cap≥30pF, Q≥350; 10pF≤Cap&lt;30pF, Q≥275+2.5C Cap&lt;10pF, Q≥200+10C * I.R.: ≥1GΩ or RxC≥50Ω-F whichever is smaller.</p>															
14.	Humidity (Damp Heat) Load	<p>* Test temp.: 40±2°C * Humidity: 90~95%RH * Test time: 500+24/-0 hrs. * To apply voltage : rated voltage (Max. 500V) * Before initial measurement (Class II only): To apply test voltage for 1hr at 40°C and then set for 24±2 hrs at room temp. * Measurement to be made after keeping at room temp. for 24±2 hrs.</p>	<p>* No remarkable damage. * Cap change: within ±7.5% or ±0.75pF whichever is larger. * Q/D.F. value: NP0: Cap≥30pF, Q≥200; Cap&lt;30pF, Q≥100+10/3C * I.R.: ≥500MΩ or RxC≥25Ω-F whichever is smaller.</p>															
15.	High Temperature Load (Endurance)	<p>* Test temp.: NP0: 125±3°C * To apply voltage: (1) &lt;500V: 200% of rated voltage. (2) 500V: 150% of rated voltage. (3) ≥630V: 120% of rated voltage. * Test time: 1000+24/-0 hrs. * Before initial measurement (Class II only): To apply test voltage for 1hr at test temp. and then set for 24±2 hrs at room temp. * Measurement to be made after keeping at room temp. for 24±2 hrs</p>	<p>* No remarkable damage. * Cap change: within ±3.0% or ±0.3pF whichever is larger. * Q/D.F. value: NP0: Cap≥30pF, Q≥350 10pF≤Cap&lt;30pF, Q≥275+2.5C Cap&lt;10pF, Q≥200+10C * I.R.: ≥1GΩ or RxC≥50Ω-F whichever is smaller.</p>															



**APPENDIXES**

▣ **Tape & reel dimensions**

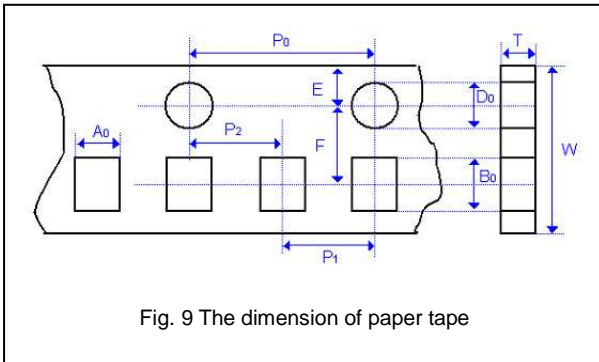

Fig. 9 The dimension of paper tape

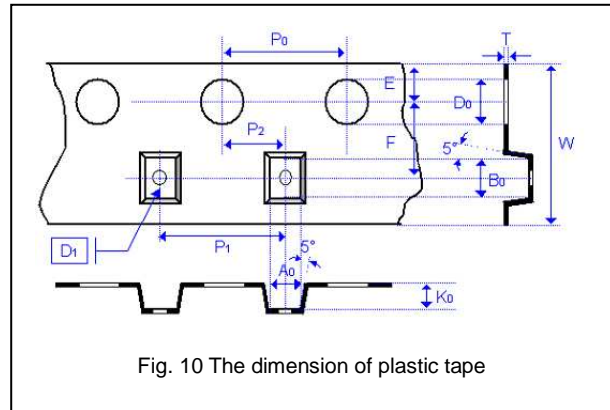

Fig. 10 The dimension of plastic tape

Size	0402	0603	0805		
Thickness	N	S, X	A	B	C, D, I
A <sub>0</sub>	0.62±0.05	1.02±0.05	1.50±0.10	1.50±0.10	<1.57
B <sub>0</sub>	1.12±0.05	1.80±0.05	2.30±0.10	2.30±0.10	<2.40
T	0.60±0.05	0.95±0.05	0.75±0.05	0.95±0.05	0.23±0.05
K <sub>0</sub>	-	-	-	-	<2.50
W	8.00±0.10	8.00±0.10	8.00±0.10	8.00±0.10	8.00±0.10
P <sub>0</sub>	4.00±0.10	4.00±0.10	4.00±0.10	4.00±0.10	4.00±0.10
10xP <sub>0</sub>	40.0±0.10	40.0±0.10	40.0±0.10	40.0±0.10	40.0±0.10
P <sub>1</sub>	2.00±0.05	4.00±0.10	4.00±0.10	4.00±0.10	4.00±0.10
P <sub>2</sub>	2.00±0.05	2.00±0.05	2.00±0.05	2.00±0.05	2.00±0.05
D <sub>0</sub>	1.55±0.05	1.55±0.05	1.55±0.05	1.55±0.05	1.50±0.05
D <sub>1</sub>	-	-	-	-	1.00±0.10
E	1.75±0.05	1.75±0.05	1.75±0.05	1.75±0.05	1.75±0.10
F	3.50±0.05	3.50±0.05	3.50±0.05	3.50±0.05	3.50±0.05

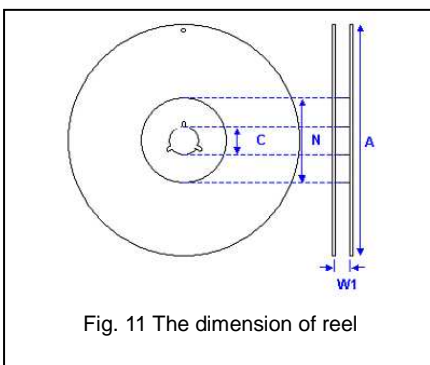
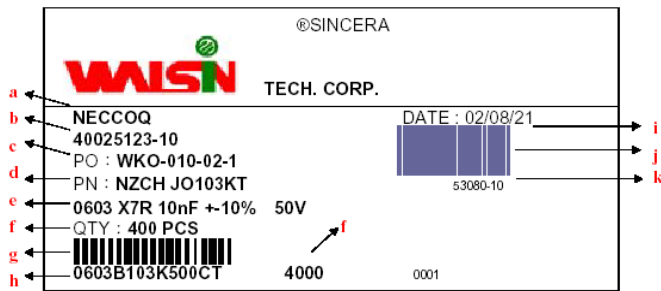

Fig. 11 The dimension of reel

Size	0402, 0603, 0805		
Reel size	7"	10"	13"
C	13.0+0.5/-0.2	13.0+0.5/-0.2	13.0+0.5/-0.2
W <sub>1</sub>	8.4+1.5/-0	8.4+1.5/-0	8.4+1.5/-0
A	178.0±0.10	250.0±1.0	330.0±1.0
N	60.0+1.0/-0	100.0±1.0	100±1.0

▣ Description of customer label



- a. Customer name
- b. WTC order series and item number
- c. Customer P/O
- d. Customer P/N
- e. Description of product
- f. Quantity
- g. Bar code including quantity & WTC P/N or customer
- h. WTC P/N
- i. Shipping date
- j. Order bar code including series and item numbers
- k. Serial number of label

▣ Constructions

No.	Name	NP0*	NP0
①	Ceramic material	CaZrO <sub>3</sub> / BaTiO <sub>3</sub> based	
②	Inner electrode	AgPd alloy	Ni
③	Termination	Inner layer	Ag
④		Middle layer	Ni
⑤		Outer layer	Sn

\* Partial NP0 items are with Ag/Ni/Sn(NME) terminations, please ref to product range for detail.

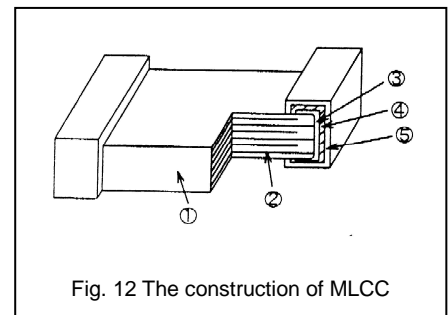

Fig. 12 The construction of MLCC

▣ Storage and handling conditions

- (1) To store products at 5 to 40°C ambient temperature and 20 to 70% related humidity conditions.
- (2) The product is recommended to be used within one year after shipment. Check solderability in case of shelf life extension is needed.

Cautions:

- a. The corrosive gas reacts on the terminal electrodes of capacitors, and results in the poor solderability. Do not store the capacitors in the ambience of corrosive gas (e.g., hydrogen sulfide, sulfur dioxide, chlorine, ammonia gas etc.)
- b. In corrosive atmosphere, solderability might be degraded, and silver migration might occur to cause low reliability.
- c. Due to the dewing by rapid humidity change, or the photochemical change of the terminal electrode by direct sunlight, the solderability and electrical performance may deteriorate. Do not store capacitors under direct sunlight or dewing condition. To store products on the shelf and avoid exposure to moisture.

☑ Recommended soldering conditions

The lead-free termination MLCCs are not only to be used on SMT against lead-free solder paste, but also suitable against lead-containing solder paste. If the optimized solder joint is requested, increasing soldering time, temperature and concentration of N<sub>2</sub> within oven are recommended.

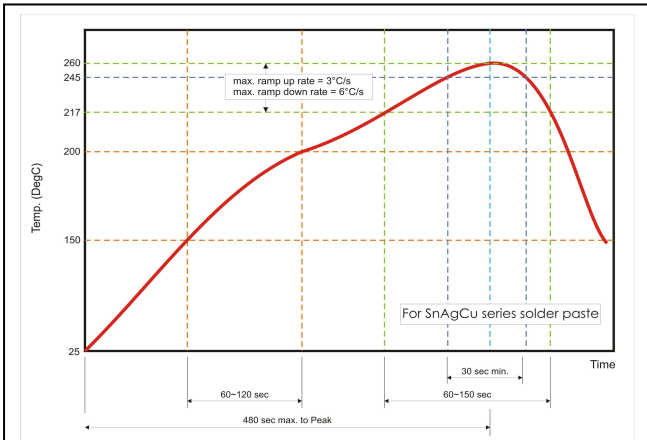

Fig. 13 Recommended reflow soldering profile for SMT process with SnAgCu series solder paste.

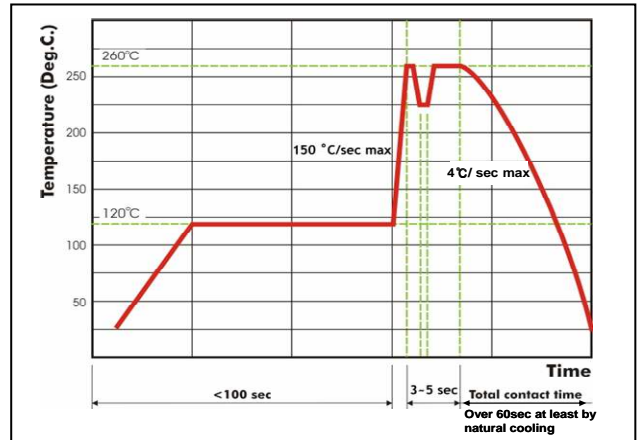

Fig. 14 Recommended wave soldering profile for SMT process with SnAgCu series solder.

Компания «Океан Электроники» предлагает заключение долгосрочных отношений при поставках импортных электронных компонентов на взаимовыгодных условиях!

Наши преимущества:

- Поставка оригинальных импортных электронных компонентов напрямую с производств Америки, Европы и Азии, а так же с крупнейших складов мира;
- Широкая линейка поставок активных и пассивных импортных электронных компонентов (более 30 млн. наименований);
- Поставка сложных, дефицитных, либо снятых с производства позиций;
- Оперативные сроки поставки под заказ (от 5 рабочих дней);
- Экспресс доставка в любую точку России;
- Помощь Конструкторского Отдела и консультации квалифицированных инженеров;
- Техническая поддержка проекта, помощь в подборе аналогов, поставка прототипов;
- Поставка электронных компонентов под контролем ВП;
- Система менеджмента качества сертифицирована по Международному стандарту ISO 9001;
- При необходимости вся продукция военного и аэрокосмического назначения проходит испытания и сертификацию в лаборатории (по согласованию с заказчиком);
- Поставка специализированных компонентов военного и аэрокосмического уровня качества (Xilinx, Altera, Analog Devices, Intersil, Interpoint, Microsemi, Actel, Aeroflex, Peregrine, VPT, Syfer, Eurofarad, Texas Instruments, MS Kennedy, Miteq, Cobham, E2V, MA-COM, Hittite, Mini-Circuits, General Dynamics и др.);

Компания «Океан Электроники» является официальным дистрибьютором и эксклюзивным представителем в России одного из крупнейших производителей разъемов военного и аэрокосмического назначения «JONHON», а так же официальным дистрибьютором и эксклюзивным представителем в России производителя высокотехнологичных и надежных решений для передачи СВЧ сигналов «FORSTAR».



## JONHON

«JONHON» (основан в 1970 г.)

Разъемы специального, военного и аэрокосмического назначения:

(Применяются в военной, авиационной, аэрокосмической, морской, железнодорожной, горно- и нефтедобывающей отраслях промышленности)

«FORSTAR» (основан в 1998 г.)

ВЧ соединители, коаксиальные кабели,  
кабельные сборки и микроволновые компоненты:

(Применяются в телекоммуникациях гражданского и специального назначения, в средствах связи, РЛС, а так же военной, авиационной и аэрокосмической отраслях промышленности).



Телефон: 8 (812) 309-75-97 (многоканальный)

Факс: 8 (812) 320-03-32

Электронная почта: [ocean@oceanchips.ru](mailto:ocean@oceanchips.ru)

Web: <http://oceanchips.ru/>

Адрес: 198099, г. Санкт-Петербург, ул. Калинина, д. 2, корп. 4, лит. А