

## 80 A 800 V high temperature thyristor (SCR) in D<sup>3</sup>PAK package

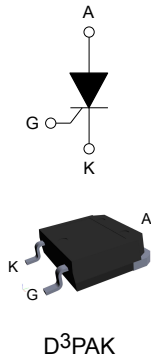

### Features

- High junction temperature:  $T_j = 150\text{ °C}$
- Blocking voltage:  $V_{DRM} = V_{RRM} = 800\text{ V}$
- Nominal current:  $I_{T(RMS)} = 80\text{ A}$
- Gate triggering current:  $I_{GT\text{ max.}} = 50\text{ mA}$
- High noise immunity:  $dV/dt > 1\text{ kV}/\mu\text{s}$
- Surface mounted device D<sup>3</sup>PAK for compact designs
- Increase of thermal margin due to extended  $T_j$  up to  $150\text{ °C}$
- Low  $I_D$  and  $I_R$  in blocking state
- [Ecopack2](#) (includes halogen free & RoHS compliance)

### Applications

- AC-DC rectifier controlled bridge
- Motorbike voltage regulator
- Variable speed motor drive
- Battery charging system
- AC solid state relay
- By-pass switch of UPS
- Industrial welding systems
- Motor soft starter

### Description

Available in power surface mount package (D<sup>3</sup>PAK), the TM8050H-8D3 device is an 800V SCR thyristor suitable for applications where high power switching ( $I_{T(RMS)} = 80\text{ A}$ ) and low power dissipation ( $V_{TM} = 1.55\text{ V}$  at  $160\text{ A}$ ) are key features. These features make it ideal for motorbike voltage regulator, by-pass AC switch, controlled rectifier bridge, solid state relay, battery charger, welding equipment and motor driver applications.

Product status link	
<a href="#">TM8050H-8D3</a>	
Product summary	
$I_{T(RMS)}$	80 A
$V_{DRM}/V_{RRM}$	800 V
$I_{GT}$	50 mA
$T_j$	$150\text{ °C}$

# 1 Characteristics

**Table 1. Absolute maximum ratings (limiting values),  $T_j = 25\text{ °C}$  unless otherwise stated**

Symbol	Parameter			Value	Unit
$I_{T(RMS)}$	RMS on-state current (180 ° conduction angle)		$T_c = 130\text{ °C}$	80	A
$I_{T(AV)}$	Average on-state current (180 ° conduction angle)			50	A
$I_{TSM}$	Non repetitive surge peak on-state current, $V_R = 0\text{ V}$	$t_p = 8.3\text{ ms}$	$T_j\text{ initial} = 25\text{ °C}$	731	A
		$t_p = 10\text{ ms}$		670	
$I^2t$	$I^2t$ value for fusing		$T_j = 25\text{ °C}$	2245	$A^2s$
$V_{RRM}/V_{DRM}$	Maximum repetitive symmetric blocking voltage			800	V
$di/dt$	Critical rate of rise of on-state current $I_G = 2 \times I_{GT}$ , $t_r \leq 100\text{ ns}$	$F = 50\text{ Hz}$	$T_j = 25\text{ °C}$	200	$A/\mu s$
$I_{GM}$	Peak gate current	$t_p = 20\text{ }\mu s$	$T_j = 150\text{ °C}$	8	A
$P_{G(AV)}$	Average gate power dissipation		$T_j = 150\text{ °C}$	1	W
$V_{RGM}$	Maximum peak reverse gate voltage			5	V
$T_{stg}$	Storage junction temperature range			-40 to +150	$^{\circ}C$
$T_j$	Operating junction temperature range			-40 to +150	$^{\circ}C$
$T_L$	Maximum lead temperature soldering during 10 s			245	$^{\circ}C$

**Table 2. Electrical characteristics ( $T_j = 25\text{ °C}$  unless otherwise specified)**

Symbol	Test conditions		Value	Unit	
$I_{GT}$	$V_D = 12\text{ V}$ , $R_L = 33\text{ }\Omega$		Min.	2.5	mA
			Max.	50	
$V_{GT}$	$V_D = 12\text{ V}$ , $R_L = 33\text{ }\Omega$		Max.	1.5	V
$V_{GD}$	$V_D = V_{DRM}$ , $R_L = 3.3\text{ k}\Omega$	$T_j = 125\text{ °C}$	Min.	0.2	V
$I_H^{(1)}$	$I_T = 500\text{ mA}$ , gate open		Max.	100	mA
$I_L$	$I_G = 1.2 \times I_{GT}$		Max.	125	mA
$t_{gt}$	$I_T = 80\text{ A}$ , $V_D = V_{DRM}$ , $I_G = 200\text{ mA}$ , $di_G/dt = 0.2\text{ A}/\mu s$		Typ.	3	$\mu s$
$dV/dt$	$V_D = 67\% V_{DRM}$ , gate open	$T_j = 150\text{ °C}$	Min.	1000	$V/\mu s$
$t_q$	$I_T = 33\text{ A}$ , $di_T/dt = 10\text{ A}/\mu s$ , $V_R = 75\text{ V}$ , $V_D = 400\text{ V}$ , $dV_D/dt = 20\text{ V}/\mu s$ , $t_p = 100\text{ }\mu s$	$T_j = 150\text{ °C}$	Max.	150	$\mu s$

1. For both polarities of A2 referenced to A1

**Table 3. Static characteristics**

Symbol	Test conditions			Value	Unit
$V_{TM}^{(1)}$	$I_{TM} = 160 \text{ A}$ , $t_p = 380 \mu\text{s}$	$T_j = 25 \text{ }^\circ\text{C}$	Max.	1.55	V
$V_{t0}^{(1)}$	On state threshold voltage	$T_j = 150 \text{ }^\circ\text{C}$	Max.	0.85	
$R_D^{(1)}$	On state dynamic resistance	$T_j = 150 \text{ }^\circ\text{C}$	Max.	5.5	m $\Omega$
$I_{DRM}$ , $I_{RRM}$	$V_D = V_{DRM} = V_R = V_{RRM} = 800 \text{ V}$	$T_j = 25 \text{ }^\circ\text{C}$	Max.	20	$\mu\text{A}$
		$T_j = 150 \text{ }^\circ\text{C}$	Max.	2.5	mA

1. For both polarities of A2 referenced to A1

**Table 4. Thermal parameters**

Symbol	Parameter	Value	Unit
$R_{th(j-c)}$	Junction to case (DC, max.)	0.25	$^\circ\text{C/W}$
$R_{th(j-a)}$	Junction to ambient (DC, typ., $S_{CU} = 2.1 \text{ cm}^2$ )	40	$^\circ\text{C/W}$

### 1.1 Characteristics curves

**Figure 1. Maximum average power dissipation versus average on-state current**

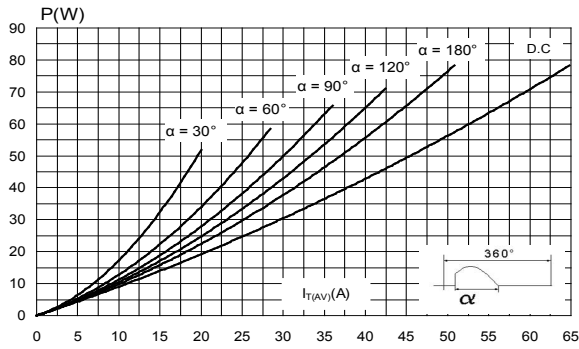

**Figure 2. Average and DC on-state current versus case temperature**

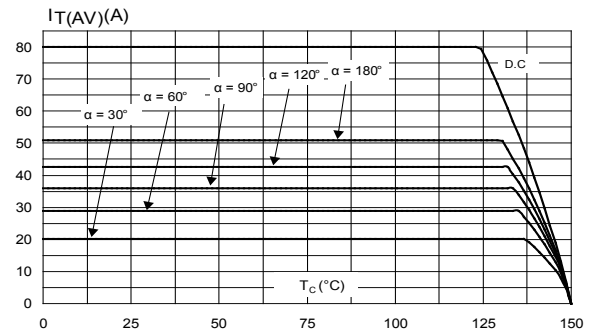

**Figure 3. On-state characteristics (maximum values)**

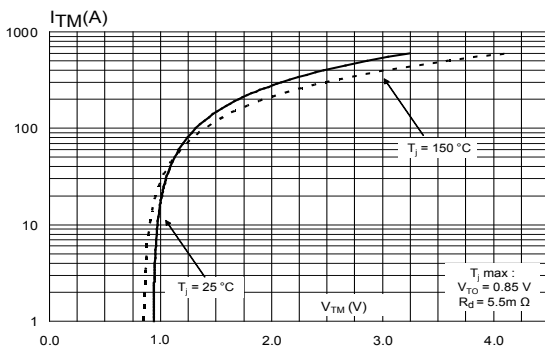

**Figure 4. Average and DC on-state current versus ambient temperature**

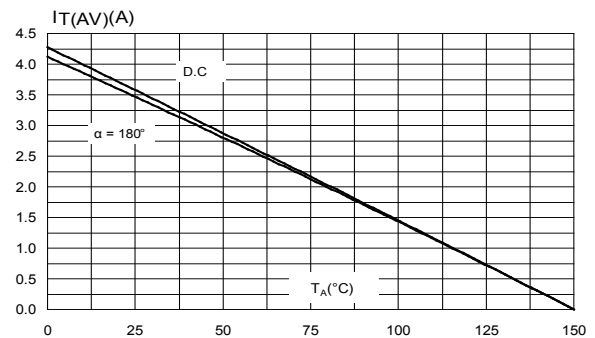

**Figure 5. Relative variation of thermal impedance versus pulse duration**

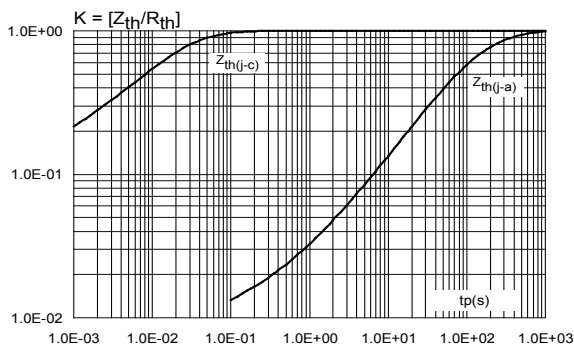

**Figure 6. Thermal resistance junction to ambient versus copper surface under tab (D<sup>3</sup>PAK printed circuit board FR4, copper thickness: 35 μm)**

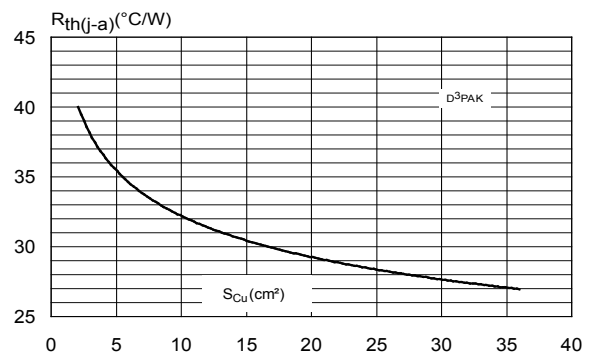

Figure 7. Surge peak on-state current versus number of cycles

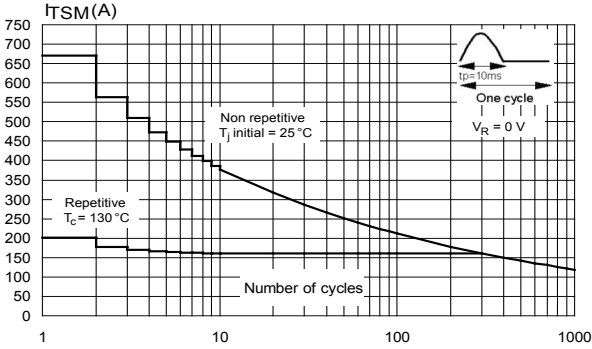

Figure 8. Non repetitive surge peak on-state current for a half cycle sine pulse versus pulse width ( $t_p < 10$  ms)

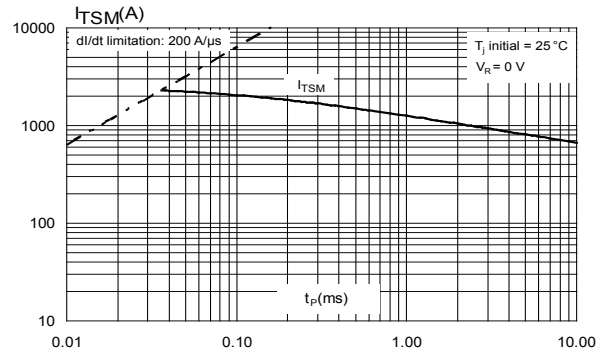

Figure 9. Relative variation of holding current and latching current versus junction temperature (typical values)

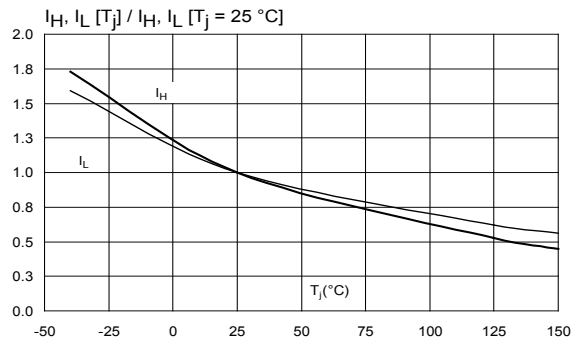

Figure 10. Relative variation of gate trigger current and gate voltage versus junction temperature

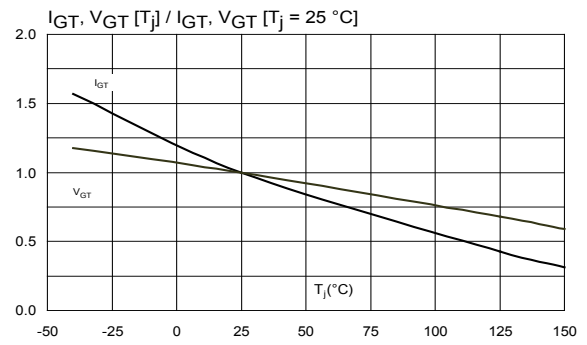

Figure 11. Relative variation of leakage current versus junction temperature for different values of blocking voltage

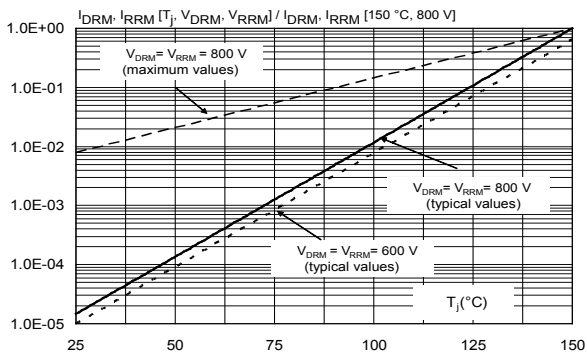
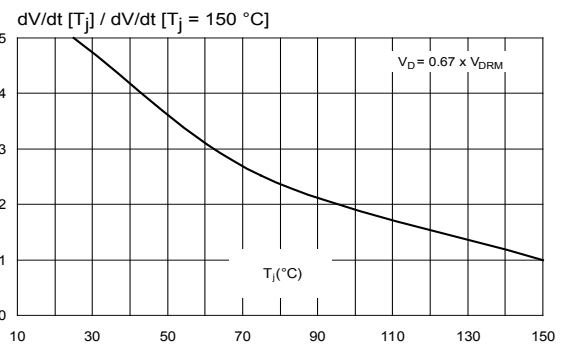

Figure 12. Relative variation of static dV/dt immunity versus junction temperature (typical values)



## 2 Package information

In order to meet environmental requirements, ST offers these devices in different grades of **ECOPACK** packages, depending on their level of environmental compliance. ECOPACK specifications, grade definitions and product status are available at: [www.st.com](http://www.st.com). ECOPACK is an ST trademark.

### 2.1 D<sup>3</sup>PAK package information

- Epoxy meets UL 94,V0
- Lead-free package leads, halogen-free molding resin
- Pre-conditioning moisture sensitivity MSL 1

**Figure 13. D<sup>3</sup>PAK package dimension definitions**

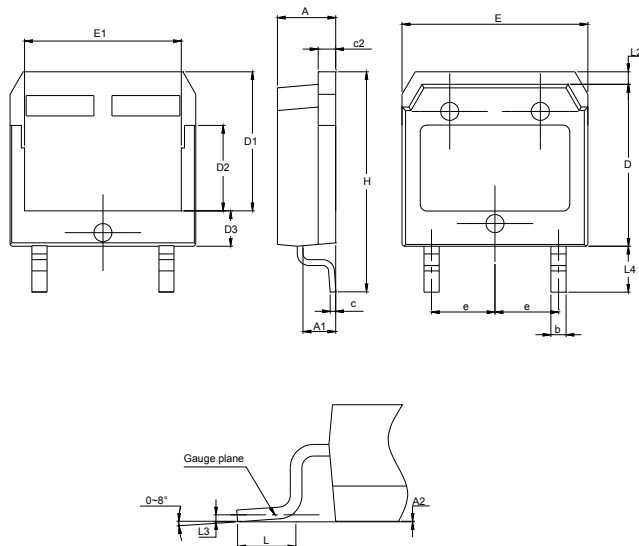
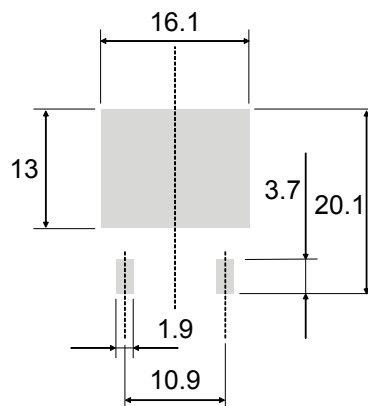

Table 5. D<sup>3</sup>PAK package mechanical data

Ref.	Dimensions					
	Millimeters			Inches (dimension in inches are given for reference only)		
	Min.	Typ.	Max.	Min.	Typ.	Max.
A	4.90		5.10	0.1929		0.2008
A1	2.70		2.90	0.1063		0.1142
A2	0.02		0.25	0.0008		0.0098
b	1.15		1.45	0.0453		0.0571
c	0.40		0.65	0.0157		0.0256
c2	1.45		1.61	0.0571		0.0634
D	13.80		14.00	0.5433		0.5512
D1	11.80		12.10	0.4646		0.4764
D2	7.50		7.80	0.2953		0.3071
D3	2.90		3.20	0.1142		0.1260
E	15.85		16.05	0.6240		0.6319
E1	13.30		13.60	0.5236		0.5354
e		5.45			0.2146	
H	18.70		19.10	0.7362		0.7520
L	1.70		2.00	0.0669		0.0789
L2	1.00		1.15	0.0394		0.0453
L3		0.25			0.0098	
L4	3.80		4.10	0.1496		0.1614

Figure 14. Minimum footprint (dimensions in mm)



### 3 Ordering information

**Figure 15. Ordering information scheme**

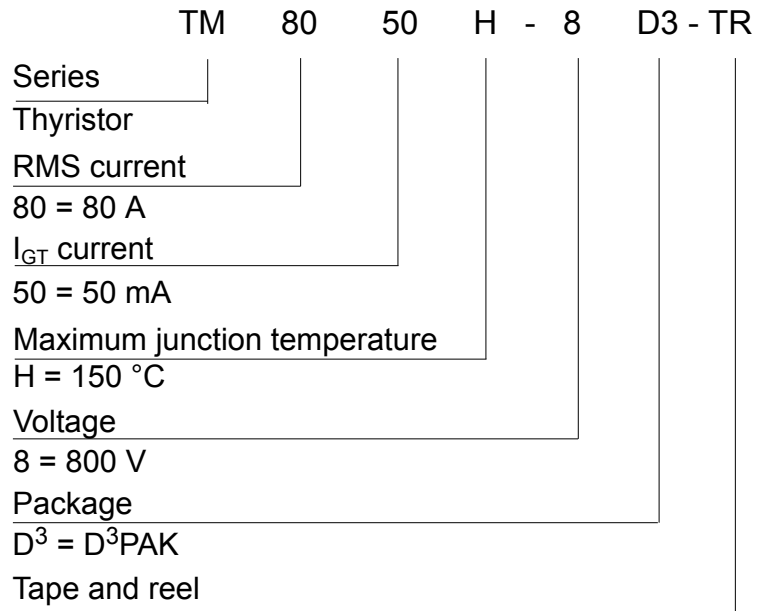

**Table 6. Ordering information**

Order code	Marking	Package	Weight	Base qty.	Delivery mode
TM8050H-8D3-TR	TM8050H8	D <sup>3</sup> PAK	4.2 g	400	Tape and reel



## Revision history

**Table 7. Document revision history**

Date	Revision	Changes
11-Feb-2016	1	Initial release.
01-Apr-2016	2	Updated Table 3: "Electrical characteristics ( $T_j = 25\text{ }^\circ\text{C}$ unless otherwise specified)".
02-May-2016	3	Updated Thermal parameters.
30-Jul-2019	4	Updated <a href="#">Table 1</a> , <a href="#">Figure 8</a> and <a href="#">Figure 9</a> . Minor text change.

**IMPORTANT NOTICE – PLEASE READ CAREFULLY**

STMicroelectronics NV and its subsidiaries (“ST”) reserve the right to make changes, corrections, enhancements, modifications, and improvements to ST products and/or to this document at any time without notice. Purchasers should obtain the latest relevant information on ST products before placing orders. ST products are sold pursuant to ST’s terms and conditions of sale in place at the time of order acknowledgement.

Purchasers are solely responsible for the choice, selection, and use of ST products and ST assumes no liability for application assistance or the design of Purchasers’ products.

No license, express or implied, to any intellectual property right is granted by ST herein.

Resale of ST products with provisions different from the information set forth herein shall void any warranty granted by ST for such product.

ST and the ST logo are trademarks of ST. For additional information about ST trademarks, please refer to [www.st.com/trademarks](http://www.st.com/trademarks). All other product or service names are the property of their respective owners.

Information in this document supersedes and replaces information previously supplied in any prior versions of this document.

© 2019 STMicroelectronics – All rights reserved

Компания «Океан Электроники» предлагает заключение долгосрочных отношений при поставках импортных электронных компонентов на взаимовыгодных условиях!

Наши преимущества:

- Поставка оригинальных импортных электронных компонентов напрямую с производств Америки, Европы и Азии, а так же с крупнейших складов мира;
- Широкая линейка поставок активных и пассивных импортных электронных компонентов (более 30 млн. наименований);
- Поставка сложных, дефицитных, либо снятых с производства позиций;
- Оперативные сроки поставки под заказ (от 5 рабочих дней);
- Экспресс доставка в любую точку России;
- Помощь Конструкторского Отдела и консультации квалифицированных инженеров;
- Техническая поддержка проекта, помощь в подборе аналогов, поставка прототипов;
- Поставка электронных компонентов под контролем ВП;
- Система менеджмента качества сертифицирована по Международному стандарту ISO 9001;
- При необходимости вся продукция военного и аэрокосмического назначения проходит испытания и сертификацию в лаборатории (по согласованию с заказчиком);
- Поставка специализированных компонентов военного и аэрокосмического уровня качества (Xilinx, Altera, Analog Devices, Intersil, Interpoint, Microsemi, Actel, Aeroflex, Peregrine, VPT, Syfer, Eurofarad, Texas Instruments, MS Kennedy, Miteq, Cobham, E2V, MA-COM, Hittite, Mini-Circuits, General Dynamics и др.);

Компания «Океан Электроники» является официальным дистрибьютором и эксклюзивным представителем в России одного из крупнейших производителей разъемов военного и аэрокосмического назначения «JONHON», а так же официальным дистрибьютором и эксклюзивным представителем в России производителя высокотехнологичных и надежных решений для передачи СВЧ сигналов «FORSTAR».



## JONHON

«JONHON» (основан в 1970 г.)

Разъемы специального, военного и аэрокосмического назначения:

(Применяются в военной, авиационной, аэрокосмической, морской, железнодорожной, горно- и нефтедобывающей отраслях промышленности)

«FORSTAR» (основан в 1998 г.)

ВЧ соединители, коаксиальные кабели, кабельные сборки и микроволновые компоненты:

(Применяются в телекоммуникациях гражданского и специального назначения, в средствах связи, РЛС, а так же военной, авиационной и аэрокосмической отраслях промышленности).



Телефон: 8 (812) 309-75-97 (многоканальный)

Факс: 8 (812) 320-03-32

Электронная почта: [ocean@oceanchips.ru](mailto:ocean@oceanchips.ru)

Web: <http://oceanchips.ru/>

Адрес: 198099, г. Санкт-Петербург, ул. Калинина, д. 2, корп. 4, лит. А